

# Design Requirements Manual

Rev. 2.0: 3/8/2024



National Institutes of Health

## Division of Technical Resources

Office of Research Facilities

The formulae  $\frac{\partial \rho U_i}{\partial t} + \frac{\partial}{\partial x_j} (\rho U_j U_i) = -\frac{\partial p}{\partial x_i} + \frac{\partial}{\partial x_j} \left( \mu \frac{\partial U_i}{\partial x_j} \right) + g_i (\rho - \rho_b)$   $\frac{\partial \rho U_i k}{\partial t} = \frac{\partial}{\partial x_j} \left( \left( \mu + \frac{\mu_t}{\sigma_k} \right) \frac{\partial k}{\partial x_j} \right) + P + G - \rho k$  for building  $\frac{\partial \rho U_i \epsilon}{\partial t} = \frac{\partial}{\partial x_j} \left( \left( \mu + \frac{\mu_t}{\sigma_\epsilon} \right) \frac{\partial \epsilon}{\partial x_j} \right) + (C_1 - C_{1,ISO}) \frac{\epsilon}{k} (P + C_2 G) - C_2 \rho \frac{\epsilon^2}{k} - \frac{\partial}{\partial x_j} (\rho U_j \epsilon) = \frac{\partial}{\partial x_j} \left( \lambda \frac{\partial T}{\partial x_j} - \rho u_j h \right)$   
 $-\rho u_j h_j = \mu_t \left( \frac{\partial U_i}{\partial x_j} + \frac{\partial U_j}{\partial x_i} \right) - \lambda \rho \alpha \theta$  state of the art  $\frac{\partial}{\partial x_j} (\rho U_j U_i) = -\frac{\partial p}{\partial x_i} + \frac{\partial}{\partial x_j} \left( \mu \frac{\partial U_i}{\partial x_j} - \rho u_j u_i \right) + g_i (\rho - \rho_b)$   $\frac{\partial \rho U_i \epsilon}{\partial t} = \frac{\partial}{\partial x_j} \left( \left( \mu + \frac{\mu_t}{\sigma_\epsilon} \right) \frac{\partial \epsilon}{\partial x_j} \right) + C_1 \frac{\epsilon}{k} (P + C_2 G) - C_2 \rho \frac{\epsilon^2}{k}$  biomedical research facilities.

The first chapters of the 2024 DRM Revision 2.0 have been published as of March 8, 2024. As of this date, Chapters 3, 5, and 9 have been revised and updated, as indicated by their green cover sheets. The rest of the update will be published chapter-by-chapter through 2024 as chapters are completed to release the information as quickly as possible. Updated chapters and appendices will replace the current *DRM* chapters and appendices as they are published. Legacy chapters from Revision 1.5 will retain their blue covers until they are updated, at which point their covers will become green. Projects referencing the *DRM* for guidance will be held to the edition that is in effect at the time the project is awarded. It is recommended that the project team download the most current version of the *DRM* available on the date of award and notate the referenced version in all project documentation.

\*The *Design Requirements Manual* is a living document and will be maintained and updated on a regular basis. The contents of this work are subject to change through both periodic development cycles as well as when revisions are determined necessary by the Division of Technical Resources. Users of the manual are encouraged to submit proposed corrections, updates, and improvements to the Standards and Policies Branch by contacting the Chief of Standards and Policy at [drm@mail.nih.gov](mailto:drm@mail.nih.gov). For a detailed list of revisions see the revisions section at the end of this document.

# Preface

The National Institutes of Health (NIH) *Design Requirements Manual (DRM)* establishes policy, design requirements, standards, and technical criteria for use in planning, programming, and designing NIH owned, leased, operated, and funded buildings and facilities. The *DRM* is the only detailed design requirements and guidance manual of its kind. The information compiled within the 2024 *DRM* is the result of technical studies that have set numerous national and international standards, lessons learned, and ever-advancing architectural and engineering technologies used in the design and construction of NIH facilities. The Division of Technical Resources (DTR) is responsible for maintaining and updating the *DRM*.

In order to ensure the most current, relevant, and comprehensive manual, DTR continuously researches and tests state-of-the-art and innovative technologies. DTR has gathered data from these studies as well as from numerous years of specialized experience and an accumulation of lessons learned. This has led to data-driven decision making and best practices for the design and construction of NIH’s facilities. The results of these studies are incorporated into the 2024 *DRM* and new information will be added as it becomes available.

The 2024 *DRM* builds upon the strong foundation of the 2016 edition. Much of the information and guidance remains the same, reviewed with an eye to the latest developments in facility design and lessons learned from seven years with the 2016 *DRM* and the intent to fine-tune existing content. DTR assembled over 100 professionals from industry, academia, and government including designers, architects, engineers, researchers, veterinarians, maintenance staff, biosafety specialists, and others, all with expertise in a variety of disciplines and unique insights into the complicated design, construction, and functional issues involved in building NIH facilities. Dedicated groups reviewed each chapter, examining and identifying content to be updated in order to provide the best possible practices and guidance for *DRM* users. This process helped DTR fine-tune the *DRM*’s design guidance and standards, which will help support the NIH mission for years to come.

The NIH *Design Requirements Manual* aligns the NIH facilities program with the Office of Research Facilities’ (ORF) mission of “Supporting NIH priorities by providing safe, secure, sound, healthy, and attractive facilities.” Additionally, this manual also aligns the ORF with a national imperative to be good stewards of America’s real property assets. We extend our sincerest thanks to all the dedicated individuals who helped to make this revision of the NIH *Design Requirements Manual* a reality.



March 8, 2024

Farhad Memarzadeh, Ph.D., P.E.  
Director; Division of Technical Resources



March 8, 2024

Daniel G. Wheeland, P.E.  
Director; Office of Research Facilities  
Development and Operations



# Acknowledgements

The NIH *Design Requirements Manual* has always been a living document that benefits from the aggregated experience and expertise of its contributors. While the 2016 edition is the foundation on which the 2024 revision builds, Revision 2.0 was made possible by the hard work of many individuals who generously provided their time and expertise. Each chapter was reviewed and revised by a dedicated committee comprised of NIH representatives along with respected industry experts from both the public and private sectors and academia.

Revisions were led by committee chairs and shaped by members who rigorously assessed chapters, identified opportunities for improvement, and provided additional content. Other contributions were made by peer reviewers, subject matter experts, editors and additional government and industry professionals. These individuals reviewed and updated existing *DRM* content to be in line with the latest industry knowledge and standards, including lessons learned from their own experiences and specialties. The *DRM*, and in turn all NIH facilities, greatly benefit from their contributions. We are indebted to these individuals and acknowledge their valued participation.

**NIH DRM 2024 Executive Committee:**

Farhad Memarzadeh, Ph.D., P.E.  
 Steven Breslin, AIA, P.E.  
 Nika Lilley  
 Scott Taylor, P.E.  
 Neetha Varghese

**2024 Chapter Chairs:**

Mat Chibbaro, P.E.  
 Ibrahim Coulibaly, P.E.  
 Paul Richards, P.E.

**2024 Committee Members:**

Robert Belcher  
 Jon Fan, P.E.  
 Jack Hui, P.E.  
 Calvin Kane, P.E.  
 Daniel Moses, P.E.  
 Alexander Mueller  
 Eric Ober, P.E.  
 Matt Rabush, P.E.  
 Ken Saks, P.E.  
 Robert Spetzler, P.E.  
 Brian Vandervort, P.E.  
 Zenia Velazquez, P.E.

We continue to extend our appreciation and acknowledgements to the following individuals who participated

in developing the 2016 edition of the *DRM*, without whom the 2024 edition would not be possible.

**NIH DRM 2016 Executive Committee:**

Farhad Memarzadeh, Ph.D., P.E.  
 Deborah Wilson, Ph.D.  
 Technical Advisors:  
 Alamelu Ramesh, P.E.  
 Scott Taylor, P.E.

**2016 Contributing Division of Technical Resources Staff:**

Abdul Bhuiyan Ph.D., P.E.  
 Steven Breslin, AIA, P.E.  
 Rajiv Chainani, P.E.  
 Ibrahim Coulibaly, P.E.  
 Patrick Dulany, R.A.  
 John Egan, AIA  
 Don Guan, Ph.D., P.E.  
 Kumars Haidari, P.E.  
 Paul Howey  
 Malee Kaolawanich, P.E.  
 Jonathan Maddox  
 Carlos R. Moreno  
 Cole Murphy, P.E.  
 John Pavlides, P.E.  
 Alamelu Ramesh, P.E.  
 Sy Sadighi, P.E.  
 Michael Shaw  
 Scott Taylor, P.E.  
 Neetha Varghese  
 Angela Watson

**2016 Technical Editors:**

Sheri Bernstein  
 Nika Lilley  
 Kate McKay

**2016 Graphic Designer:**

Robyn Bernstein

**2016 Subcommittee Members:**

Praveen Agarwal  
 Subodh Agrawal  
 Mohammad Algararheh, P.E.  
 R. Bruce Anderson, P.E.  
 Walter B. Armstrong  
 Keith Ashe  
 Ed Baker, R.A.  
 Doreen Bartlett  
 Raymond L. Beets, AIA  
 Jorge Bernal  
 Timothy Biser

Robert Bove  
Raymond Byrd  
Dave Carrol, P.E.  
Alexander P. Clinton, AIA  
Jason Cohen, P.E.  
Sarah Cottet  
Mike Daniels  
Stephen Denny  
Larry DiGennaro, AIA  
Larry Dlugosz, Ph.D.  
Raymond E. Doyle, P.E.  
Babak (Bob) Farahpour, P.E.  
Jim Galantine  
Mike Gentry  
Miguel Grimaldo  
Vibeke Halkjaer-Knudsen, Ph.D.  
Laura Halverson, P.E.  
W. Kyle Hawkins, P.E.  
John R. Henneman, RBP  
Gregory R. Johnson, P.E.  
Tracey Johnson-Butler  
Jean (Fred) P. Khoshbin, R.A.  
Kyung Kim  
Gerald Knight  
Eric D. Knoll, Ph.D.  
Gabor Konkoly-Thege  
Mary Beth Koza  
David E. Kurten, Jr, P.E.  
Paul E. Langevin, P.E.  
Dwayne Lasky  
Steven L. Leary, DVM  
Jim Lewis, P.E.  
Ivan Locke, P.E.  
Marjorie Marcus, R.A.  
Jack McDonald  
Thomas Mistretta, AIA  
Richard John Mohr, AIA  
Theodore (Todd) Mowinski, II, P.E.  
Michael P. Mottet  
Robert Murray  
Jamie Natour  
Scott Nguy  
Gregar Odegaarden  
James O'Malley, Ph.D.  
Diego Osorio Sanchez  
Lauren Pandolfo  
Mahavir Patel, P.E.  
Frank Piatkowski, AIA  
Krishnan Ramesh, P.E.  
Vilas Sawant  
David Sawyer  
Joseph 'Mat' Schech, DVM

Sam Seraj, P.E.  
Joesph F. Seufert III, P.E.  
Robert Shannon  
H. Michael Smith, AIA  
Marisa St. Claire, DVM  
John D. Stratton, R.A.  
William Stratton, AIA  
David Tash, P.E.  
Wayne Thomann, Ph.D.  
Brandon Tolbert  
Esmail Torkashvan, P.E.  
Leigh Anne Voidness  
Marni Walker  
Stephen Waller, P.E.  
Philip Walter, P.E.  
Daniel Watch, FAIA  
Stan Whatley, R.A.  
David Williams  
Gerald G. Williams, P.E.  
Christina Willis, AIA  
Jim Wilson, Jr  
Michael C. Wood, P.E.  
Lily Xu  
Uri Yokel, AIA  
Kazem Youssefi, P.E.  
Gary Zackowitz, R.A.  
Jeffrey R. Zynda

**2016 Reviewing Members:**

Deborah Addad  
Kevin Anderson  
J. Wade Atkins  
Austin Bailey, AIA  
Emmett Barkley, Ph.D.  
Stephen Blair, P.E.  
Patrick Brady, AIA  
Michael Brueggerhoff  
Scott Burger, M.D.  
William Caron, P.E.  
Tom Checksfield  
Salvatore P. Ciampa, AIA  
Saverino (Rino) Clarizio  
Laura A. Clary, R.A.  
William Cleaveland, R.A.  
Jim Coogan, P.E.  
Ed Cordes, AIA  
Chris Cowansage, R.A.  
J.R. Crowell, R.A.  
Sylvia Darr, R.A.  
Kenneth G. DeBoer, AIA  
Samuel A. Denny, P.E.  
Louis DiBerardinis, CIH

Shawn M. Diederich, P.E.  
 Elena Dominguez  
 Carol Donovan  
 Clarence Dukes  
 David B. Duthu, P.E.  
 Andrew A. Dymek, P.E.  
 Dondi Pulse Earl  
 Cory English, R.A.  
 David W. Esch, AIA  
 Eilyn N. Fabregas, RBP  
 Robert Fagg, P.E.  
 Mark Fitzgerald  
 Jason M. Fligger, Ph.D.  
 Ian Frank, R.A.  
 Dan Frasier, P.E.  
 William C. Frye  
 Mark Gibson, CIH  
 Norm Goldschmidt  
 Michael Halligan  
 Jerome Haney  
 Jeffrey Hardin, P.E.  
 Lou Hartman, P.E.  
 Brandon Hartz, PLA  
 Andreas Hausler, AIA  
 Stephanie Hixson  
 Mark Huza  
 Christopher Jenkins, RBP  
 Eric R. Jeppesen, RBP  
 Bryan Jewell  
 Ralph Edward John, P.E.  
 Bruce William Johnson, P.E.  
 Marvin Kemp, AIA  
 George Kemper, R.A.  
 Christopher J. Kiley, P.E.  
 Jeff Kim, AIA  
 Scott A. Kimble, R.A.  
 Chuck (Charles) Kirby  
 Katherine Kittredge, R.A.  
 Richard F. Kmiecik, P.E.  
 Randall Larsen  
 Tim Lee, P.E.  
 Ned Leverage  
 Thomas Ligis  
 David Linamen, P.E.  
 Robert E. Lloyd  
 Tiffini L. Lovelace, R.A.  
 Trevor Lubbert  
 Jurij Orest Luchanko, R.A.  
 Jared Ray Machala, P.E.  
 Kathy Manigo-Lewis  
 Juha Mattila  
 J.P. McCabe, P.E.  
 Gary McKelvey, Jr.  
 Ned Michalowski  
 Gary L. Miller, P.E.  
 Francis Anthony Mills, P.E.  
 John C. Mlade  
 Rand Mortimer  
 Karen Pharaoh Murphy  
 Eric Andrew Myracle, P.E.  
 Gary S. Nagamori  
 Ali Najafi, P.E.  
 Barbara Fox Nellis, RBP  
 Michael Oppelt  
 Juan Osorio Sanchez  
 Suketu R. Patel, R.A.  
 Amelia Patino Gonzalez  
 Fernando Perez Castro, P.E.  
 John Petersen  
 Joseph E. Popp, AIA  
 Tony Ramis, P.E.  
 Michael Reagan, AIA  
 Gaylon Richardson  
 Tim Riordan, P.E.  
 Janet Ross, R.A.  
 Rosamond Rutledge-Burns  
 Vikram Sarni  
 Nachiappan Sathappan, R.A.  
 Anil Saxena, RBP  
 Boggarm S. Setty, P.E.  
 Moshe Shalev, DVM  
 Gordon P. Sharp  
 Ellen Sisle, AIA  
 Thomas C. Smith  
 Steve Stinnette, AIA  
 Travis T. Stout, P.E.  
 Reardon D. Sullivan, P.E.  
 Clare Swanson, AIA  
 Joe Tanelli, P.E.  
 Thomas Teel  
 Erik Terry  
 Rafael Torres-Cruz  
 Anthony Trang  
 Ted Traum  
 Cindy Utley, RBP  
 John Vilgos  
 Brian Weinmeister  
 Bruce Werfel, AIA  
 Ernest Williams, P.E.  
 Linda Williams  
 Glenn Wilson  
 Joseph H. Wilson  
 Paul E. Witt  
 Alexei A. Zemskov, P.E.

# Table of Contents

## Chapter 1: Administration

<b>Section 1.1 General Administration</b> .....	25
1.1.0 Introduction .....	26
1.1.1 <i>DRM</i> General Information.....	26
1.1.2 Codes, Standards & Guiding Principles .....	27
<b>Section 1.2 Referenced Codes, Standards, and Organizations</b> .....	30
1.2.0 Introduction.....	31
1.2.1 Required Codes and Standards .....	31
1.2.2 Additional Guidance.....	32
1.2.3 Office of Research Facilities Development and Operations/Office of Research Services.....	33
<b>Section 1.3 Definitions</b> .....	34
1.3.0 Introduction.....	35
1.3.1 List of Definitions .....	35
<b>Section 1.4 Measurement of Space</b> .....	44
1.4.0 Introduction .....	45
1.4.1 Measurement Details & Calculations .....	45
1.4.2 Net Assignable Area .....	45
1.4.3 Rentable Area .....	45
<b>Section 1.5 Project Design Review</b> .....	46
1.5.0 Introduction.....	47
1.5.1 Variance Request Procedures .....	47
1.5.2 Design Submissions.....	48
1.5.3 Roles and Responsibilities.....	48
<b>Section 1.6 Project Cost Monitoring and Control</b> ..	49
1.6.0 Introduction.....	50
1.6.1 Programmatic Requirements.....	50
1.6.2 Cost Monitoring Procedures.....	50
1.6.3 Estimate Requirements .....	50
<b>Section 1.7 Value Engineering</b> .....	51
1.7.0 Introduction .....	52
1.7.1 Design Contract Value Engineering Procedures .....	52
1.7.2 Construction Contract VE Procedures .....	53
1.7.3 VE Regulations .....	53
1.7.4 VE in Research Facilities .....	53
<b>Section 1.8 Sustainable Design</b> .....	54
1.8.0 Introduction.....	55
1.8.1 Principles.....	55
1.8.2 Sustainability Policy.....	56
<b>Section 1.9 Accessibility</b> .....	59
1.9.0 Introduction .....	60
1.9.1 Guidance and Information .....	60
<b>Section 1.10 Commissioning</b> .....	61
1.10.0 Introduction .....	62
1.10.1 NIH Cx Requirements .....	62
1.10.2 Cx Process During Different Project Phases .....	63
<b>Section 1.11 Environmental Management and Radiation Safety</b> .....	66
1.11.0 Introduction .....	67
1.11.1 Common Safety Issues.....	67
1.11.2 Safety Guidelines and References .....	68
1.11.3 General Hazardous Substances Receiving, Storage, Staging, and Handling Criteria .....	68
1.11.4 Bulk Storage Facilities/Above-Ground Storage Tanks.....	72
1.11.5 Decommissioning.....	73
1.11.6 Radiation Safety.....	74
<b>Section 1.12 Integrated Pest Management</b> .....	80
1.12.0 Introduction .....	81
1.12.1 Integrated Pest Management .....	81
1.12.2 IPM Program Components .....	81
1.12.3 Facility Design Elements .....	82
1.12.4 Pest Management Consultation, Design Review, and Program Support .....	82
1.12.5 Pest Management Services During Construction.....	83
<b>Section 1.13 Security Requirements and Procedures</b>	84
1.13.0 Introduction .....	85
1.13.1 Security Role/Responsibilities .....	85
1.13.2 Applicability.....	85
1.13.3 References .....	86
1.13.4 Procedures.....	86

1.13.5 Additional Requirements .....	87	2.2.4 Personnel Support Areas .....	125
1.13.6 Nondisclosure Warning.....	87	2.2.5 Circulation Areas .....	127
<b>Section 1.14 Inspection, Acceptance, Activation, and Occupancy .....</b>	<b>89</b>	2.2.6 Building Operation Areas .....	128
1.14.0 Introduction .....	90	2.2.7 Utility Distribution .....	129
1.14.1 Critical Facility Risk Assessment and Certification.....	90	2.2.8 Conceptual Design .....	129
1.14.2 Inspection and Acceptance.....	90	2.2.9 Room Data Sheets .....	129
1.14.3 Occupancy .....	92	<b>Section 2.3 Animal Research Facility Predesign ....</b>	<b>130</b>
1.14.4 Operations and Maintenance Manuals .....	92	2.3.0 Introduction.....	131
<b>Section 1.15 Common Engineering Systems’ Requirements.....</b>	<b>93</b>	2.3.1 Animal Research Facility: Project Programming .....	131
1.15.0 Introduction .....	94	2.3.2 Animal Research Facility Planning .....	132
1.15.1 Common Engineering Requirements .....	94	2.3.3 Biological Risk Assessment and Biosafety Level Criteria.....	138
1.15.2 Preservation of Service .....	96	2.3.4 Design Considerations .....	138
1.15.3 Technical Requirements of Systems’ Planning.....	97	2.3.5 Plan and Program Deliverables .....	144
1.15.4 Supplemental Technical Requirements for Animal Research Facilities .....	101	<b>Section 2.4 Animal Research Facility Design .....</b>	<b>145</b>
1.15.5 Supplemental Technical Requirements for High Containment Facilities.....	102	2.4.0 Introduction.....	146
1.15.6 Risk Assessment, Systems Failure & Disaster Mitigation.....	104	2.4.1 Design Requirements .....	146
1.15.7 Failure Corrections and Root Cause Analysis .....	106	2.4.2 Modular Design.....	146
1.15.8 Specification of Contractor Qualifications .....	107	2.4.3 Materials and Finishes .....	147
<b>Chapter 2: Planning and Programming</b>		2.4.4 ARF Security .....	148
<b>Section 2.1 Research Laboratory Predesign .....</b>	<b>109</b>	2.4.5 Design Considerations .....	148
2.1.0 Introduction.....	110	2.4.6 Utility Systems .....	154
2.1.1 The Master Plan.....	110	<b>Section 2.5 Biocontainment Facility Predesign .....</b>	<b>155</b>
2.1.2 Project Program .....	111	2.5.0 Introduction.....	156
2.1.3 Laboratory Planning .....	113	2.5.1 The Master Plan.....	157
2.1.4 Predesign Deliverables.....	120	2.5.2 Project Program .....	157
<b>Section 2.2 Research Laboratory Design .....</b>	<b>121</b>	2.5.3 Biocontainment Facility Planning .....	159
2.2.0 Introduction .....	122	2.5.4 Additional Considerations .....	164
2.2.1 Conceptual Design Considerations .....	122	2.5.5 Planning and Programming Deliverables..	166
2.2.2 Modular Design .....	123	<b>Section 2.6 Biocontainment Facility Design .....</b>	<b>167</b>
2.2.3 Laboratory Areas.....	124	2.6.0 Introduction.....	168
		2.6.1 Conceptual Design Considerations .....	168
		2.6.2 Facility Design Requirements .....	169
		2.6.3 Security.....	170
		2.6.4 Additional Considerations .....	170
		<b>Exhibit 2.1 Research Facilities Program Questionnaire .....</b>	<b>171</b>

Exhibit 2.2 Animal Research Facility Program Questionnaire .....	174
Exhibit 2.3 Biocontainment Facilities Program Questionnaire .....	178
<b>Chapter 3: Civil Engineering &amp; Site Development</b>	
<b>Section 3.1 Site Civil Design .....</b>	<b>185</b>
3.1.0 Introduction .....	186
3.1.1 Codes and Standards.....	186
3.1.2 Design Documentation .....	187
<b>Section 3.2 Site Development .....</b>	<b>188</b>
3.2.0 Introduction.....	189
3.2.1 Site Development Design.....	189
3.2.2 Local Requirements.....	189
<b>Section 3.3 Site Utilities .....</b>	<b>191</b>
3.3.0 Introduction.....	192
3.3.1 Utility Piping Standards .....	192
3.3.2 Site Utilities Design Requirements .....	192
3.3.3 Identification of Underground Utilities .....	195
3.3.4 Local Requirements .....	196
3.3.5 Additional Water Systems Requirements ..	196
3.3.6 Additional Gravity Sewer Requirements...	196
<b>Section 3.4 Site Improvements .....</b>	<b>198</b>
3.4.0 Introduction.....	199
3.4.1 Site Improvement Requirements.....	199
3.4.2 Local Requirements .....	201
<b>Section 3.5 Landscaping .....</b>	<b>202</b>
3.5.0 Introduction.....	203
3.5.1 New Plantings.....	203
3.5.2 Landscape Maintenance and Pest Management .....	204
3.5.3 Plant Removal and Replacement.....	204
3.5.4 Campus Trees .....	204
Exhibit 3.1 Tree Replacement Matrix.....	206
Exhibit 3.2 Sample Tree Replacement Calculation Charts .....	208

## Chapter 4: Architectural Design

<b>Section 4.1 Exterior Envelope .....</b>	<b>211</b>
4.1.0 Introduction .....	212
4.1.1 General Requirements .....	212
4.1.2 Exterior Walls.....	213
4.1.3 Roofing .....	214
4.1.4 Windows .....	215
4.1.5 Window Coverings.....	217
4.1.6 External Shading.....	217
4.1.7 Mock-Up.....	217
<b>Section 4.2 Doors .....</b>	<b>218</b>
4.2.0 Introduction.....	219
4.2.1 General Requirements.....	219
4.2.2 Laboratory Doors .....	221
4.2.3 Animal Research Facility Doors .....	223
4.2.4 Specialty Doors, Frames, and Hardware...	224
<b>Section 4.3 Partitions .....</b>	<b>226</b>
4.3.0 Introduction.....	227
4.3.1 General Requirements.....	227
4.3.2 Laboratory Partitions.....	228
4.3.3 ARF Partitions.....	229
<b>Section 4.4 Interior Finishes .....</b>	<b>231</b>
4.4.0 Introduction.....	232
4.4.1 General Requirements.....	232
4.4.2 Minimum Requirements .....	232
4.4.3 Laboratory Finishes .....	234
4.4.4 ARF Finishes.....	235
4.4.5 Wall and Ceiling Finishes for Aseptic Facilities, BSL-3, ABSL-3, and Similar Facilities.....	238
<b>Section 4.5 Casework and Millwork .....</b>	<b>240</b>
4.5.0 Introduction.....	241
4.5.1 General Requirements.....	241
4.5.2 General Use Casework and Millwork .....	242
4.5.3 Laboratory Casework .....	242
4.5.4 ARF Casework.....	245



<b>Section 4.6 Furnishings and Equipment .....</b>	<b>246</b>	5.1.5 Anchor Design of Critical Substructures in Tension .....	277
4.6.0 Introduction.....	247	5.1.6 Below-Grade Extensions .....	277
4.6.1 General Requirements.....	247	5.1.7 Equipment Access.....	277
4.6.2 ARF Equipment and Furnishings.....	251	5.1.8 Flatness and Levelness of Concrete Floors	278
<b>Section 4.7 Vertical Transportation .....</b>	<b>253</b>	5.1.9 Geotechnical Report .....	278
4.7.0 Introduction .....	254	5.1.10 Demolition and Post Installed Holes and Openings in Concrete Construction.....	278
4.7.1 General Requirements .....	254	5.1.11 Primary Structural Support .....	278
4.7.2 Escalators .....	261	5.1.12 Secondary Structural Support .....	279
4.7.3 Wheelchair Lifts.....	261	5.1.13 Future Expansion and Alteration .....	279
<b>Section 4.8 Loading Docks .....</b>	<b>262</b>	5.1.14 Formwork for Reinforced Concrete Construction.....	279
4.8.0 Introduction.....	263	5.1.15 Use of Recycled Materials in Concrete ..	279
4.8.1 General Requirements.....	263	5.1.16 Additional Requirements .....	280
4.8.2 Waste-Handling Areas.....	265	5.1.17 Adjacent Construction.....	280
4.8.3 Animal Research Facility Loading Dock ..	265	5.1.18 Design Documentation .....	280
<b>Section 4.9 BSL-3 and ABSL-3 Biocontainment ....</b>	<b>266</b>	<b>Section 5.2 Structural Loads and Demands .....</b>	<b>281</b>
4.9.0 Introduction .....	267	5.2.0 Introduction.....	282
4.9.1 Barriers.....	267	5.2.1 Loads .....	282
4.9.2 Exterior Envelope.....	267	5.2.2 Vibration .....	285
4.9.3 Doors .....	267	5.2.3 Thrust Blocks .....	285
4.9.4 Partitions.....	268	<b>Section 5.3 Animal Research Facilities .....</b>	<b>286</b>
4.9.5 Interior Finishes .....	268	5.3.0 Introduction.....	287
4.9.6 Penetrations and Sealants.....	269	5.3.1 Structural Bay Dimensions.....	287
4.9.7 Access Panels.....	269	5.3.2 Location.....	287
4.9.8 Casework .....	270	5.3.3 Vibration.....	287
4.9.9 Decontamination .....	270	5.3.4 Floor Slab Depressions.....	287
4.9.10 Autoclaves .....	270	5.3.5 Prevention of Progressive Collapse.....	287
4.9.11 Equipment .....	271	5.3.6 Security .....	288
4.9.12 Signage .....	272	<b>Section 5.4 BSL-3 and ABSL-3 Biocontainment ....</b>	<b>289</b>
4.9.13 Mock-ups .....	272	5.4.0 Introduction .....	290
4.9.14 Commissioning.....	273	5.4.1 Codes and Standards.....	290
4.9.15 Certification .....	273	5.4.2 Standards of Quality.....	290
<b>Chapter 5: Structural Design</b>		5.4.3 Prevention of Progressive Collapse.....	290
<b>Section 5.1 Structural Design .....</b>	<b>275</b>	5.4.4 Serviceability.....	290
5.1.0 Introduction .....	276	5.4.5 Loads .....	290
5.1.1 Codes, Standards and Design Guides .....	276	5.4.6 Importance Factors .....	291
5.1.2 Planning.....	276	5.4.7 Shielding .....	291
5.1.3 Prevention of Building Progressive Collapse.....	276	5.4.8 Other Requirements.....	291
5.1.4 Blast Resistance Design .....	277		

## Chapter 6: Mechanical Design

### Section 6.1 Heating, Ventilation, and Air Conditioning Design ..... 293

6.1.0 Introduction .....	294
6.1.1 Heating, Ventilation, and Air Conditioning System Standards and Definitions for NIH Facilities .....	294
6.1.2 General Planning Requirements.....	295
6.1.3 Heating and Cooling Load Calculations ...	295
6.1.4 Animal Population Density .....	296
6.1.5 Occupancy Loads.....	296
6.1.6 Lighting Loads .....	297
6.1.7 Outdoor Design Conditions .....	297
6.1.8 HVAC System Design Requirements .....	297
6.1.9 Indoor Design Conditions .....	300
6.1.10 Indoor Design Conditions for Administrative Areas .....	301
6.1.11 Ventilation Rates .....	302
6.1.12 Individual Ventilated Cages.....	304
6.1.13 Relative Room Pressurization.....	304
6.1.14 Air Distribution Systems.....	306
6.1.15 Anterooms.....	308
6.1.16 Program Equipment .....	308
6.1.17 Environmental Rooms.....	311
6.1.18 HVAC Design for Equipment Rooms .....	312
6.1.19 Mechanical Equipment Location and Access .....	313
6.1.20 Heating Systems.....	313
6.1.21 Cooling Systems .....	313
6.1.22 Exhaust Air Systems .....	314
6.1.23 Energy Conservation, Efficiency, and Recovery .....	317
6.1.24 Systems Failure and Disaster Mitigation .	319

### Exhibit 6.1 Helium Quench Pipe Failure, Room Pressure Analysis Methodology ..... 320

Helium Quench Pipe Failure, Room Pressure Analysis Methodology .....	321
--	-----

### Section 6.2: Supply Air Handling Systems ..... 323

6.2.0 Introduction.....	324
6.2.1 Supply and Exhaust Air Handling Capacity.....	324

6.2.2 Ductwork Design.....	324
6.2.3 Outdoor Air Intakes and Exhaust Air Discharge.....	327
6.2.4 Air Handling Units .....	327
6.2.5 Air Filtration Systems .....	331
6.2.6 Humidification Systems .....	332
6.2.7 Fans .....	332
6.2.8 Motor and Variable Frequency Drives .....	333
6.2.9 Emergency Electrical Power Generators ...	336

### Section 6.3: Piping Systems ..... 339

6.3.0 Introduction.....	340
6.3.1 Hydronic Systems.....	340
6.3.2 Hydronic Pipe Sizing.....	340
6.3.3 Hydronic Pump .....	341
6.3.4 Hydronic Coil .....	341
6.3.5 Heating Water Systems .....	342
6.3.6 Chilled Water Systems .....	342
6.3.7 Steam Systems.....	346
6.3.8 Freeze Protection Measures for 100% Outside Air Handling Coils.....	350
6.3.9 Piping.....	352

### Exhibit 6.3 Piping Designation, Material, Fittings, and Joints ..... 355

### Section 6.4: Thermal Insulation Systems ..... 401

6.4.0 Introduction.....	402
6.4.1 General Insulation Requirements .....	402
6.4.2 Insulation Material for Piping.....	403
6.4.3 Insulation Thickness for Piping & Hot/Cold Equipment.....	403
6.4.4 Supply, Return, and Outdoor Air Ductwork Insulation .....	404

### Exhibit 6.4: Insulation Material, Thickness, and Specifications for Piping and Ductwork..... 405

### Section 6.5: Noise and Vibration ..... 412

6.5.0 Introduction.....	413
6.5.1 General Design Considerations .....	413
6.5.2 Room Noise Levels .....	413
6.5.3 Outdoor Noise Control.....	413
6.5.4 Ductwork and Fan Sound Control.....	414

6.5.5 Machinery Sound-Level Criteria.....	415	7.1.10 Design Document Submittal.....	430
6.5.6 Piping and Ductwork Vibration-Isolation Criteria.....	415	7.1.11 Shop Drawings and Record Document Submittals .....	433
6.5.7 Machinery Vibration Criteria .....	416	7.1.12 Documentation Format .....	436
<b>Section 6.6: BSL-3 &amp; ABSL-3 Biocontainment .....</b>	<b>419</b>	<b>Section 7.2 Infrastructure .....</b>	<b>437</b>
6.6.0 Introduction.....	420	7.2.0 Introduction .....	438
6.6.1 Design Requirements .....	420	7.2.1 General Requirements.....	438
6.6.2 Supply Air Systems.....	421	7.2.2 Integration with Existing Systems.....	439
6.6.3 Ventilation Rates in BSL-3 Laboratories...	421	7.2.3 Integration with Newly Installed Systems .	440
6.6.4 Ventilation Rates in ABSL-3 Laboratories	421	7.2.4 Controller Networks .....	440
6.6.5 Relative Room Pressurization .....	421	7.2.5 Servers .....	441
6.6.6 Anterooms .....	422	7.2.6 Operator Workstations .....	441
6.6.7 Exhaust Air Systems .....	422	7.2.7 Remote Connections .....	443
6.6.8 Air Filtration.....	422	7.2.8 Intranet Remote Connections .....	443
6.6.9 Isolation Dampers.....	423	<b>Section 7.3 Applications .....</b>	<b>444</b>
6.6.10 Autoclaves.....	423	7.3.0 Introduction .....	445
6.6.11 Service Access Panels and Mechanical Spaces .....	424	7.3.1 Building-Level Requirements.....	445
6.6.12 Variable Frequency Drives.....	424	7.3.2 Zone-Level Requirements .....	446
6.6.13 Emergency Electrical Power .....	424	7.3.3 Laboratories.....	446
6.6.14 Equipment, Ductwork, and Piping Identification .....	424	7.3.4 Animal Holding Rooms .....	448
6.6.15 Biosecurity .....	424	7.3.5 General Pressure-Controlled Rooms .....	449
6.6.16 Seismic Accommodation .....	424	7.3.6 Principal Investigator (PI) Offices.....	449
6.6.17 HVAC Plans.....	425	7.3.7 Microscope Suites .....	449
6.6.18 Inspection, Testing, Validation, and Certification .....	425	7.3.8 Nuclear Magnetic Resonance and Magnetic Resonance Imaging Suites.....	450
<b>Chapter 7: Building Automation Systems</b>		7.3.9 Computer Rooms .....	450
<b>Section 7.1 Design Considerations .....</b>	<b>427</b>	7.3.10 Environmental Rooms.....	450
7.1.0 Introduction .....	428	7.3.11 Electrical Vaults.....	451
7.1.1 General Requirements .....	428	7.3.12 Loading Docks/Shipping and Receiving Areas .....	451
7.1.2 BAS Overview .....	428	7.3.13 Freezer Farms .....	451
7.1.3 BAS Growth.....	428	7.3.14 Laboratory Corridors .....	451
7.1.4 Renovation and Rehabilitation .....	429	7.3.15 Conference/Meeting Rooms .....	451
7.1.5 Codes, Standards and References .....	429	7.3.16 Enclosed Garages .....	451
7.1.6 Standardization .....	429	<b>Section 7.4 Systems-Level Requirements .....</b>	<b>452</b>
7.1.7 Access Requirements .....	429	7.4.0 Introduction .....	453
7.1.8 Point-Naming Conventions .....	429	7.4.1 General Requirements .....	453
7.1.9 Design Planning and Coordination .....	429	7.4.2 Air Handling Systems.....	453

7.4.3 Stairwell Pressurization Systems.....	455	<b>Section 7.6 Installation .....</b>	<b>474</b>
7.4.4 Exhaust Air Systems.....	455	7.6.0 Introduction .....	475
7.4.5 Building Steam Connections to Campus System .....	456	7.6.1 System Controller Configuration: General Requirements.....	475
7.4.6 Clean Steam (Steam Source Boiler and Steam-to-Steam Generator) Systems.....	457	7.6.2 Temperature Sensors .....	478
7.4.7 Hydronic Systems .....	457	7.6.3 Humidity Sensors.....	479
7.4.8 Plumbing and Specialty Gas Systems.....	459	7.6.4 Pressure Sensors .....	479
7.4.9 Fuel Oil Systems .....	460	7.6.5 Flow Sensors .....	480
7.4.10 Laboratory Air Systems .....	460	7.6.6 Compressed Air Systems .....	482
7.4.11 Control Compressed-Air Systems .....	460	7.6.7 Control Tubing.....	483
7.4.12 Vacuum Systems .....	460	7.6.8 Control Wiring.....	483
7.4.13 Desiccant Dehumidification Systems .....	460	7.6.9 Wall Penetrations .....	483
7.4.14 Electrical Systems .....	461	7.6.10 Protection from Transients .....	484
<b>Section 7.5 Component-Level Requirements .....</b>	<b>462</b>	7.6.11 Software and Software Set-Up Requirements.....	484
7.5.0 Introduction .....	463	7.6.12 Operator Workstations Hardware.....	486
7.5.1 General Requirements .....	463	7.6.13 Commissioning.....	486
7.5.2 Fans.....	463	<b>Section 7.7 BSL-3 and ABSL-3 Biocontainment .....</b>	<b>487</b>
7.5.3 Variable Frequency Drives.....	465	7.7.0 Introduction.....	488
7.5.4 Pumps .....	465	7.7.1 BSL-3 Laboratory: General Requirements.....	488
7.5.5 Coils (in AHUs over 1,500 L/s [3,180 cfm]).....	466	7.7.2 BSL-3 Laboratory: Additional Requirements .....	489
7.5.6 Converters.....	467	7.7.3 ABSL-3 Laboratory: General Requirements.....	490
7.5.7 Heat Exchangers: Fluid to Fluid .....	468	7.7.4 General Pressure-Controlled Rooms.....	490
7.5.8 Humidifiers .....	468	7.7.5 BSL-3 Laboratories: Supply Systems .....	490
7.5.9 Exhaust Air Ducts.....	468	7.7.6 BSL-3 Laboratories: Exhaust Systems.....	491
7.5.10 Filter Racks (Including Pre-, Final, and HEPA).....	469	7.7.7 BSL-3 Laboratories: Drainage and Waste Systems .....	491
7.5.11 Exhaust Air Stacks (Contaminated Systems).....	469	7.7.8 Exhaust Air Stacks (Contaminated Systems).....	491
7.5.12 Heat-Recovery Wheels .....	469	7.7.9 Variable Frequency Drives in Critical Applications .....	491
7.5.13 Variable Air Volume/ Constant Volume Terminals.....	470	7.7.10 Installation Requirements .....	492
7.5.14 Fume Hoods .....	471	7.7.11 Performance and Verification.....	492
7.5.15 Ducted Biological Safety Cabinets.....	472		
7.5.16 Miscellaneous Terminal Units .....	472		
7.5.17 Active Chilled-Beam Terminal Units .....	472		
7.5.18 Glycol Run Around Heat Recovery Coils	473		

**Chapter 8: Plumbing Design**

<b>Section 8.1 Plumbing General Requirements</b> .....	<b>494</b>
8.1.0 Introduction .....	495
8.1.1 Design Conformance.....	495
8.1.2 Applicable Codes and Standards.....	495
8.1.3 General Planning Requirements.....	496
8.1.4 System Materials .....	497
8.1.5 Common Technical Requirements .....	497
8.1.6 Additional Requirements for Animal Research Facilities .....	503
8.1.7 Pressure-Relief Devices.....	504
8.1.8 Sanitary Process Systems and Clean Spaces .....	504
8.1.9 Shared Lab/Clinical Crossover Spaces.....	505
8.1.10 Additional General Technical Requirements .....	505
8.1.11 Requirements for Plumbing Document Submissions .....	506
8.1.12 Specification of Contractor Qualifications .....	508
8.1.13 Testing and Commissioning .....	509
8.1.14 Utility Metering.....	509
<b>Section 8.2 Plumbing Fixtures and Equipment</b> .....	<b>511</b>
8.2.0 Introduction.....	512
8.2.1 General Requirements.....	512
8.2.2 Special Requirements for Stainless Steel Products .....	512
8.2.3 Water Closets.....	513
8.2.4 Urinals.....	513
8.2.5 Lavatories/Sinks/Hand Sinks .....	514
8.2.6 Faucets and Spouts .....	516
8.2.7 Foot Pedal and Dual Actuation Valves.....	519
8.2.8 Battery-Powered and Self-Sustaining Automatic Faucets and Flushometers .....	519
8.2.9 Showers .....	520
8.2.10 Emergency Showers and Eyewash .....	521
8.2.11 Janitor Sinks/Mop Sinks/Janitor Closets.	524
8.2.12 Drinking Fountains and Bottle Fillers.....	525
8.2.13 Hose Bibb/Hydrants .....	525
8.2.14 Waste Disposers .....	526
8.2.15 Dishwashers .....	526
8.2.16 Lab and Animal Research Facility Equipment .....	527
8.2.17 Lab Sinks .....	527
8.2.18 Labware Washers and Autoclaves .....	527
8.2.19 Incubators.....	528
8.2.20 Fume Hoods and Biological Safety Cabinets .....	528
8.2.21 Lab Gas Turrets .....	528
8.2.22 Downdraft/Backdraft/Necropsy/Tables, Dissection/Grossing Stations, and Equipment Served from Lab Water .....	529
8.2.23 Hose Stations.....	530
8.2.24 Lab Equipment Water/Waste Outlet Box	530
8.2.25 Fixture Trim Requirements .....	531
8.2.26 Floor Drain and Floor Sinks: General Requirements .....	532
8.2.27 Roof and Overflow Drains .....	540
<b>Section 8.3 Water Systems</b> .....	<b>541</b>
8.3.0 Introduction.....	542
8.3.1 General Requirements.....	542
8.3.2 Water Service .....	543
8.3.3 Water Storage Tanks.....	546
8.3.4 Distribution Systems .....	546
8.3.5 Building Water System: General Design Criteria .....	549
8.3.6 Backflow Protection.....	552
8.3.7 Emergency Fixture Water.....	555
8.3.8 Hot Water Systems.....	557
8.3.9 Hot Water Circulation and Temperature Maintenance .....	561
8.3.10 Hot Water System Temperature Control and Over-Temperature Protection.....	562
8.3.11 Additional Requirements for Animal Research Facilities .....	564
8.3.12 Corrosion Protection, Water Treatment, and Control of Scale .....	565
8.3.13 Available Water Supply/ Water Supply Analysis.....	566
8.3.14 Research Equipment Water .....	566
8.3.15 Equipment and Material .....	567
8.3.16 Quality Control, Startup, and Verification.....	567

<b>Section 8.4 Drainage Systems .....</b>	<b>569</b>	<b>Section 8.6 BSL-3 and ABSL-3 Biocontainment ....</b>	<b>614</b>
8.4.0 Introduction.....	570	8.6.0 Introduction.....	615
8.4.1 Systems Approach .....	570	8.6.1 BSL-3 General Plumbing Requirements ....	615
8.4.2 Discharge Prohibitions.....	570	8.6.2 Water Systems Serving BSL-3.....	615
8.4.3 All Systems: General Requirements.....	574	8.6.3 High Purity Water Serving BSL-3 .....	617
8.4.4 Piping System Slope/Grade.....	576	8.6.4 Animal Drinking Water Systems Serving ABSL-3.....	618
8.4.5 Piping Size.....	576	8.6.5 Vacuum Systems Serving BSL-3 Laboratories .....	619
8.4.6 Cleanouts: All Drainage Systems.....	577	8.6.6 Compressed Gases Serving BSL-3 .....	622
8.4.7 Sanitary, Lab, ARF, and Grease Waste and Vent Systems: General Requirements .....	578	8.6.7 Veterinary Medical Gas Systems.....	623
8.4.8 Potential High Temperature Waste .....	580	8.6.8 Critical Compressed Air/ Control Air Serving BSL-3 .....	625
8.4.9 Gravity Drainage, Pumps and Ejectors, and Backflow of Waste.....	581	8.6.9 Waste and Vent Systems Serving BSL-3 ....	625
8.4.10 Indirect Waste, Direct Waste, and Equipment Connections.....	582	8.6.10 Liquid Nitrogen and Cryogenic Fluids Serving BSL-3 Laboratories .....	630
8.4.11 Trap Seal Maintenance.....	587	8.6.11 Plumbing Fixtures Serving BSL-3 Laboratories .....	630
8.4.12 Deep Seal Traps.....	588	8.6.12 Special Materials and Equipment.....	632
8.4.13 Laboratory and Corrosion-Resistant Waste Systems: Additional Requirements.....	588	8.6.13 BSL-3 Plumbing Requirements for Special Applications .....	633
8.4.14 Animal Research Facility Waste: Additional Requirements .....	589	8.6.14 Containment Autoclave Chamber Pressure Relief.....	634
8.4.15 pH Monitoring and Neutralization: General Requirements.....	591	8.6.15 Special Testing and Inspection Requirements.....	635
8.4.16 Alternatives to Automatic Central Building pH Treatment .....	596		
8.4.17 Grease Waste and Fats, Oil, and Grease Control: Additional Requirements .....	597		
8.4.18 Non-Emulsified Oil-Based Waste .....	599		
8.4.19 Condensate Drainage .....	599		
8.4.20 Storm, Clear Water Waste and Specialty Systems: Additional Requirements .....	601		
8.4.20.7 Parking Garage Drainage.....	604		
8.4.21 Sump, Sewage, and Lab Waste Pumps ....	604		
8.4.22 Quality Assurance, Startup, and Verification.....	606		
<b>Section 8.5 Natural Gas/Fuel Gas Systems .....</b>	<b>608</b>		
8.5.0 Introduction.....	609		
8.5.1 Systems Approach .....	609		
8.5.2 General Requirements.....	609		
8.5.3 Testing and Purge Requirements.....	612		
		<b>Chapter 9: Fire Protection &amp; Suppression</b>	
		<b>Section 9.1 Fire Protection Systems.....</b>	<b>638</b>
		9.1.0 Introduction .....	639
		9.1.1 Codes and Standards.....	639
		9.1.2 Authority Having Jurisdiction.....	639
		9.1.3 Occupancy Classification .....	639
		9.1.4 Laboratory Fire Hazard Classification .....	639
		9.1.5 Fire Resistance-Rated Construction .....	639
		9.1.6 Flammable Liquid Storage Cabinets .....	640
		9.1.7 Glazing.....	640
		9.1.8 Listed Equipment .....	640
		9.1.9 Design Documentation.....	640
		<b>Section 9.2 Fire Suppression Systems .....</b>	<b>642</b>
		9.2.0 Introduction.....	643
		9.2.1 Automatic Sprinkler Systems.....	643
		9.2.2 Standpipe Systems.....	646



9.2.3 Fire Hydrants.....	646	<b>Section 10.3 Emergency Power .....</b>	<b>680</b>
9.2.4 Fire Department Connections (FDCs).....	647	10.3.0 Introduction.....	681
9.2.5 Fire Pumps.....	647	10.3.1 Emergency Electrical Systems.....	681
<b>Section 9.3 Fire Alarm and Mass</b>		10.3.2 Emergency Power Generation .....	683
<b>Notification Systems .....</b>	<b>648</b>	10.3.3 Emergency Power Distribution.....	684
9.3.0 Introduction.....	649	10.3.4 Other Requirements.....	686
9.3.1 Fire Alarm Systems.....	649	<b>Section 10.4 Site Electrical Distribution .....</b>	<b>687</b>
9.3.2 Fire Alarm System Installation.....	651	10.4.0 Introduction .....	688
9.3.3 NIH Bethesda Campus Mass		10.4.1 Distribution Duct Systems.....	688
Notification Requirements.....	651	10.4.2 Manhole and Handhole Installation .....	689
<b>Section 9.4 Life Safety Features .....</b>	<b>653</b>	<b>Section 10.5 Wiring Methods and</b>	
9.4.0 Introduction .....	654	<b>Other Requirements .....</b>	<b>691</b>
9.4.1 Means of Egress .....	654	10.5.0 Introduction.....	692
9.4.2 Fire Department Access .....	654	10.5.1 Conductors and Cables .....	692
9.4.3 Fire Extinguishers .....	654	10.5.2 Raceway.....	694
9.4.4 Smoke Control Systems .....	655	10.5.3 Wiring Devices.....	697
9.4.5 Dampers.....	655	10.5.4 Other Requirements.....	698
9.4.6 Emergency Power .....	655	10.5.5 Laboratory and Animal	
9.4.7 In-Building Signal Amplification.....	655	Research Facility.....	699
<b>Section 9.5 BSL-3 and ABSL-3 Biocontainment .....</b>	<b>656</b>	<b>Section 10.6 Power Quality and Grounding .....</b>	<b>701</b>
9.5.0 Introduction.....	657	10.6.0 Introduction.....	702
9.5.1 Fire Protection Systems .....	657	10.6.1 Harmonics .....	702
9.5.2 Design Documentation .....	658	10.6.2 Uninterruptible Power Source .....	702
		10.6.3 Transient Voltage Surge Suppression.....	703
		10.6.4 Grounding.....	703
		10.6.5 Lightning Protection .....	705
<b>Chapter 10: Electrical Design</b>		<b>Section 10.7 Lighting .....</b>	<b>706</b>
<b>Section 10.1 Electrical Systems Design .....</b>	<b>660</b>	10.7.0 Introduction .....	707
10.1.0 Introduction .....	661	10.7.1 Lighting Design Guidelines.....	707
10.1.1 System Growth.....	661	10.7.2 Interior Lighting.....	707
10.1.2 Renovation and Rehabilitation.....	661	10.7.3 Exterior Lighting.....	709
10.1.3 Unusual Electrical System Design.....	661	10.7.4 Lamps.....	710
10.1.4 Codes and Standards.....	661	10.7.5 Lighting Control.....	712
10.1.5 Design Documentation.....	661	10.7.6 Animal Research Facility Lighting	
10.1.6 Testing and Operational Requirements ...	664	and Controls .....	713
<b>Section 10.2 Electrical Service and Normal Power .....</b>	<b>666</b>	<b>Section 10.8 BSL-3 and ABSL-3 Biocontainment ..</b>	<b>718</b>
10.2.0 Introduction.....	667	10.8.0 Introduction.....	719
10.2.1 Electrical Power Distribution .....	667	10.8.1 Electrical Power Systems .....	719
10.2.2 Electrical Service.....	671	10.8.2 General Requirements.....	720
10.2.3 Motor Control .....	676		
10.2.4 Electrical Work Space .....	677		
10.2.5 Other Requirements.....	679		



10.8.3 Conduit, Conductors, Cables, and Boxes	721
10.8.4 Lighting.....	721

## Chapter 11: Telecommunication Design

<b>Section 11.1 Telecommunication Systems Design ..</b>	<b>724</b>
11.1.0 Introduction .....	725
11.1.1 Telecommunications System Growth.....	725
11.1.2 Renovation and Rehabilitation.....	725
11.1.3 Codes and Standards.....	725
11.1.4 Design Documentation.....	725
<b>Section 11.2 Telecommunications/Local Area Network Closet/Room Construction Criteria .....</b>	<b>726</b>
11.2.0 Introduction.....	727
11.2.1 Telecommunications Closet.....	727
11.2.2 Additional Requirements .....	730
<b>Section 11.3 Cable Management .....</b>	<b>732</b>
11.3.0 Introduction .....	733
11.3.1 Inter-Building Riser.....	733
11.3.2 Cable Management System .....	733
11.3.3 Horizontal Pathways.....	734
<b>Section 11.4 Site Utility .....</b>	<b>735</b>
11.4.0 Introduction .....	736
11.4.1 Duct Bank Construction .....	736
11.4.2 Underground Concrete Utility Structures	736
11.4.3 Outside Plant (OSP) Pull Boxes/ Handholes.....	737
<b>Section 11.5 AudioVisual Systems .....</b>	<b>738</b>
11.5.0 Introduction .....	739
11.5.1 Audiovisual .....	739
11.5.2 General Notes .....	740
<b>Section 11.6 Antenna and Miscellaneous Systems Requirements .....</b>	<b>741</b>
11.6.0 Introduction .....	742
11.6.1 Antenna.....	742
11.6.2 Miscellaneous Systems .....	744
<b>Section 11.7 Security Systems .....</b>	<b>745</b>
11.7.0 Introduction .....	746
11.7.1 Security Systems .....	746

## Chapter 12: Special Process Piping Systems

<b>Section 12.1 High Purity Water Systems .....</b>	<b>750</b>
12.1.0 Introduction.....	751
12.1.1 Purified Water System: Common Requirements .....	751
12.1.2 Centrally Distributed High Purity Water	755
12.1.3 Point of Use Polisher and Complete Point of Use Production Systems .....	756
12.1.4 Purified Water for Special Applications...	758
12.1.5 Production Systems: Common Requirements .....	758
12.1.6 Distribution Systems: Common Requirements .....	769
12.1.7 Flow Control/Balancing/Monitoring .....	775
12.1.8 Special Provisions for Microbial Control and Sanitization .....	776
12.1.9 Quality Control and Quality Assurance .	779
12.1.10 System Completion, Startup and Verification.....	780
<b>Section 12.2 Animal Drinking Water Systems .....</b>	<b>781</b>
12.2.0 Introduction .....	782
12.2.1 General Requirements .....	782
12.2.2 ADW Production Systems.....	785
12.2.3 Barrier Facilities .....	792
12.2.4 Microbial Control.....	793
12.2.5 Distribution .....	797
12.2.6 Disaster Mitigation.....	800
12.2.7 Materials .....	800
12.2.8 Startup and Verification .....	804
<b>Section 12.3 Compressed Gas and Cryogenic Systems .....</b>	<b>805</b>
12.3.0 Introduction.....	806
12.3.1 General Design Requirements.....	806
12.3.2 Bulk Gas and Cryogenic Systems.....	812
12.3.3 Compressed Gas System Sizing, Components, and General Distribution Requirements.....	815
12.3.4 Compressed Air Systems, Additional Requirements .....	816

12.3.5 Supply Manifold Systems.....	821
12.3.6 CO <sub>2</sub> Lab Gas, Additional Requirements .....	822
12.3.7 Liquid and Gaseous Lab Nitrogen/Argon, Additional Requirements .....	824
12.3.8 Ultra-High Purity, Hazardous, and Specialty Gas.....	824
<b>Section 12.4 Laboratory Vacuum Systems .....</b>	<b>825</b>
12.4.0 Introduction.....	826
12.4.1 General Design Requirements .....	826
12.4.2 Laboratory Vacuum Quality.....	828
12.4.3 Laboratory Vacuum System Equipment ..	828
12.4.4 Laboratory Vacuum Distribution.....	831
12.4.5 Laboratory Vacuum System Testing.....	832
<b>Section 12.5 Veterinary Medical Gas Systems for Animal Research Facilities .....</b>	<b>833</b>
12.5.0 Introduction.....	834
12.5.1 Systems Configuration Overview .....	834
12.5.2 General Design Requirements.....	834
12.5.3 VMGS Equipment .....	838
12.5.4 Quality Assurance and Systems Verification .....	839
12.5.5 VMGS System-Specific Additional Requirements .....	840
12.5.6 VMGS Outlets and Terminal Unit Location, Quantity, and Placement.....	849
12.5.7 Barrier and Quarantine Facilities.....	851
<b>Section 12.6 Plumbing Requirements for Specialized Equipment .....</b>	<b>852</b>
12.6.0 Introduction.....	853
12.6.1 General Requirements.....	853
12.6.2 Hazardous Process Fluid Systems .....	853
12.6.3 Remote Bedding Disposal Systems.....	856
12.6.4 Detergent Systems/Cage Wash and Similar Applications.....	857

## Chapter 13: Aseptic Production Facilities

<b>Section 13.1 General Aseptic Production Facility Requirements .....</b>	<b>859</b>
13.1.0 Introduction .....	860
13.1.1 Statutes, Regulations, Standards, and Guidelines .....	861
13.1.2 Coordination Between Statutes, Regulations, Standards, and Guidelines.....	864
13.1.3 Definitions.....	865
13.1.4 Abbreviations .....	875
<b>Section 13.2 Predesign Phase .....</b>	<b>880</b>
13.2.0 Introduction.....	881
13.2.1 Project Initiation .....	881
13.2.2 Data Collection (Predesign) .....	882
13.2.3 Documentation (Predesign).....	883
13.2.4 APF Contractor Qualifications .....	886
13.2.5 Deliverables / Document Review and Approval (Predesign) .....	888
13.2.6 Supplier Qualification.....	888
<b>Section 13.3 Design Phase .....</b>	<b>890</b>
13.3.0 Introduction.....	891
13.3.1 Schematic Design (SD) .....	891
13.3.2 Design Development (DD) .....	891
13.3.3 APF Design Considerations.....	893
13.3.4 Common APF Design Elements .....	896
13.3.5 Design Review and Design Qualification .....	900
13.3.6 Value Engineering (VE) and Sustainable Design Requirements .....	901
13.3.7 Commissioning and Validation Activities (Design) .....	901
13.3.8 Document Change Control.....	902
13.3.9 SOP for Construction .....	903
13.3.10 Non-Inspection FDA Meetings .....	903
13.3.11 Deliverables (Design).....	903
13.3.12 Document Review and Approval (Design) .....	904

<b>Section 13.4 Biologics Facilities</b> .....	<b>906</b>	<b>Section 13.8 APF Design Requirements: HVAC</b> .....	<b>934</b>
13.4.0 Introduction .....	907	13.8.0 Introduction .....	935
13.4.1 General Plan Arrangement .....	907	13.8.1 Cleanroom Classification System .....	935
13.4.2 Biologics APF Design Recommendations	908	13.8.2 Outdoor Design Conditions .....	936
<b>Section 13.5 Compounding Pharmacy Facilities</b> ....	<b>910</b>	13.8.3 Indoor Design Conditions .....	936
13.5.0 Introduction .....	911	13.8.4 Dedicated HVAC Systems .....	936
13.5.1 Pharmacy: Compounding Regulations ....	911	13.8.5 Redundancy .....	936
13.5.2 Compounded Sterile Preparations (CSP)		13.8.6 Ventilation Criteria .....	936
USP <797> Risk Levels .....	912	13.8.7 Air Change Rate .....	937
13.5.3 Hazardous Drugs (HD) as CSPs		13.8.8 Pressurization .....	937
USP <800> .....	912	13.8.9 Airlocks .....	938
13.5.4 Direct Compounding Area (DCA) .....	912	13.8.10 Air Distribution System .....	939
13.5.5 Primary Engineering Controls (PEC) .....	913	13.8.11 Air Handling Capacity .....	940
13.5.6 Buffer Areas .....	914	13.8.12 Ductwork Design .....	940
13.5.7 Anteroom Requirements .....	914	13.8.13 Air Intake/Exhaust .....	940
13.5.8 Pharmacy Support Areas .....	915	13.8.14 Air Handling Units (AHU) .....	940
13.5.9 Radiopharmacy Design Requirements ....	915	13.8.15 Air Filtration .....	941
<b>Section 13.6 APF Design Requirements:</b>		13.8.16 Exhaust Air Systems .....	942
<b>Architectural</b> .....	<b>918</b>	13.8.17 Humidification System .....	942
13.6.0 Introduction .....	919	13.8.18 Chilled Water Systems .....	943
13.6.1 Ceilings .....	919	13.8.19 Heating Water Systems .....	943
13.6.2 Walls .....	921	13.8.20 Steam System .....	943
13.6.3 Doors & Hardware .....	922	13.8.21 Piping .....	943
13.6.4 Windows .....	924	13.8.22 Service Access Panels, Mechanical	
13.6.5 Wall Accessories .....	924	Spaces and Maintenance Consideration .....	944
13.6.6 Floors .....	926	13.8.23 Emergency Electrical Power .....	944
13.6.7 Furnishings .....	927	13.8.24 Equipment, Ductwork, and	
13.6.8 High-Performance Coatings .....	927	Piping Identification .....	944
13.6.9 Modular Components .....	928	<b>Section 13.9 APF Design Requirements: HVAC</b>	
13.6.10 Caulks and Sealants .....	929	<b>Controls</b> .....	<b>945</b>
13.6.11 Mock-ups .....	930	13.9.0 Introduction .....	946
13.6.12 Finish Cleaning Schedule .....	930	13.9.1 General Requirements .....	946
<b>Section 13.7 APF Design Requirements:</b>		13.9.2 Terminal Units .....	946
<b>Structural</b> .....	<b>931</b>	13.9.3 Isolation Dampers .....	946
13.7.0 Introduction .....	932	13.9.4 Differential Pressure Monitors .....	946
13.7.1 Structural Capacities .....	932	13.9.5 Critical Parameter Control and Sensors ..	947
13.7.2 Floor Flatness .....	932	13.9.6 Room Pressurization Control .....	948
13.7.3 Vibration Control .....	933	13.9.7 Controllers and Supply/ Exhaust Interlock .....	948

13.9.8 Loss of Pressurization .....	949	<b>Section 13.13 APF Design Requirements:</b>	
13.9.9 Cross-Limiting Loop.....	949	<b>Low-Voltage Systems .....</b>	<b>970</b>
13.9.10 Airflow Tracking .....	949	13.13.0 Introduction .....	971
13.9.11 UPS and Emergency Power .....	949	13.13.1 Telephone and CIT Outlets .....	971
13.9.12 Terminal Damper Actuators.....	949	13.13.2 Closed Circuit Television (CCTV).....	971
13.9.13 Interface on Variable Frequency Drives (VFDs) .....	950	13.13.3 Information Technology.....	971
13.9.14 Fan Failure.....	950	<b>Section 13.14 APF Design Requirements:</b>	
13.9.15 HVAC Controls Resilience and Recovery .....	950	<b>Environmental Monitoring System (EMS) .....</b>	<b>972</b>
13.9.16 Additional BAS Quality Requirements ..	950	13.14.0 Introduction .....	973
<b>Section 13.10 APF Design Requirements:</b>		13.14.1 General Requirements .....	973
<b>Plumbing .....</b>	<b>952</b>	13.14.2 Equipment Monitoring System .....	974
13.10.0 Introduction .....	953	13.14.3 Program and Graphic of EMS.....	974
13.10.1 General Requirements .....	953	13.14.4 Local Indicator .....	975
13.10.2 Domestic Cold and Hot Water Systems.	953	13.14.5 Alarm and Voice Access .....	975
13.10.3 Pharmaceutical Water .....	955	13.14.6 Controller.....	976
13.10.4 Drain and Vent System .....	958	13.14.7 Temperature and Moisture/ Humidity Transmitters .....	976
13.10.5 Sinks and Faucets .....	958	13.14.8 Room Differential Pressure Transducers	976
13.10.6 Emergency Fixtures.....	958	<b>Section 13.15 Construction Phase .....</b>	<b>977</b>
13.10.7 Liquid Nitrogen (LN <sub>2</sub> ).....	959	13.15.0 Introduction .....	978
13.10.8 Clean Compressed Gases .....	959	13.15.1 Contracting Officer's Representative (COR) Requirements.....	979
13.10.9 Pharmaceutical Compressed Air .....	961	13.15.2 Construction Quality .....	979
13.10.10 Vacuum .....	962	13.15.3 Clean Build Requirements.....	981
<b>Section 13.11 APF Design Requirements:</b>		13.15.4 Pest Management .....	982
<b>Fire Protection .....</b>	<b>963</b>	13.15.5 Construction Submittals .....	982
13.11.0 Introduction .....	964	13.15.6 Testing, Adjusting, and Balancing (TAB) .....	984
13.11.1 Automatic Sprinkler Systems .....	964	13.15.7 Commissioning Activities (Construction).....	984
<b>Section 13.12 APF Design Requirements:</b>		13.15.8 Factory Acceptance Test (FAT) & Site Acceptance Test (SAT).....	984
<b>Electrical .....</b>	<b>965</b>	<b>Section 13.16 Facility Commissioning, Qualification, and Validation Phase .....</b>	<b>988</b>
13.12.0 Introduction .....	966	13.16.0 Introduction .....	989
13.12.1 General Requirements .....	966	13.16.1 Validation Master Plan (VMP) .....	989
13.12.2 Normal Power.....	966	13.16.2 Project Validation Master Plan (PVMP)	989
13.12.3 Emergency Power Systems.....	966	13.16.3 Commissioning Master Plan (CMP).....	991
13.12.4 Wiring Methods.....	967	13.16.4 Qualification Plan (QP) .....	994
13.12.5 Power Quality .....	968	13.16.5 Integrated Commissioning, Qualification and Validation (CQV) Services.....	998
13.12.6 Lighting .....	968		
13.12.7 Emergency Fixtures.....	969		

<b>Section 13.17 APF Certification Requirements</b> ....	1000	13.20.8 Training and Education .....	1027
13.17.0 Introduction.....	1001	13.20.9 Auditing.....	1027
13.17.1 Airborne Particle Test (APT) .....	1001	<b>Exhibit 13.1 APF Questionnaire</b> .....	1028
13.17.2 Airflow Visualization Study (AVS).....	1003	<b>Exhibit 13.2 APF Room Data Sheet</b> .....	1033
13.17.3 HEPA Filter Integrity Test (FIT) .....	1004	<b>Exhibit 13.3 APF Certificate of Use Checklist</b> .....	1036
13.17.4 Temperature Uniformity Test (TUT) ...	1004	<b>Exhibit 13.4 Aseptic Project Execution Plan</b> <b>(PEP) Checklist</b> .....	1038
13.17.5 Lighting Uniformity Test (LUT) .....	1005	<b>Exhibit 13.5 APF Tests Roles and Responsibilities</b>	1040
13.17.6 Cleaning Integrity Test (CIT).....	1005	<b>Exhibit 13.6 APF Sealant Table</b> .....	1042
13.17.7 Sound Pressure Test (SPT) .....	1007		
13.17.8 Airflow Test (AFT) .....	1007		
13.17.9 Airflow Pressure Differential Test (APD) .....	1008		
13.17.10 Environmental Monitoring (EM).....	1008		
13.17.11 Environmental Monitoring Performance Qualification (EMPQ).....	1010	<b>Appendix</b>	
<b>Section 13.18 Project Closeout and Facility Handover Phase</b> .....	1012	<b>Appendix A: Biological Safety Cabinet (BSC) Placement Requirements for New Buildings and Renovations</b> .....	1048
13.18.0 Introduction .....	1013	<b>Appendix B: Downdraft Table Particle Capture Efficiency Calculation</b> .....	1055
13.18.1 Certificate of Use.....	1014	<b>Appendix C: BAS for Bethesda Campus and Satellite Sites</b> .....	1063
13.18.2 Dashboards .....	1014	<b>Appendix D: HVAC</b> .....	1074
<b>Section 13.19 Cleaning and Sanitation</b> .....	1016	<b>Appendix E: A/E Submission Requirements</b> .....	1091
13.19.0 Introduction .....	1017	<b>Appendix F: Room Data Sheets</b> .....	1103
13.19.1 Finish Selection for Cleanability .....	1017	Lab Type: Laboratory Equipment .....	1104
13.19.2 Facility Cleaning SOP.....	1018	Lab Type: Autoclave.....	1106
13.19.3 Cleaning, Sanitizing, and Disinfecting Chemicals .....	1019	Lab Type: Cold Room.....	1108
13.19.4 Cleaning Air Systems.....	1019	Lab Type: Cleanroom .....	1110
13.19.5 Cleaning Protocols .....	1019	Lab Type: Cage Wash.....	1112
13.19.6 Cleaner Qualifications.....	1020	Lab Type: Biochemistry/Wet Lab.....	1114
<b>Section 13.20 Operations &amp; Maintenance</b> .....	1021	Lab Type: Tissue Culture .....	1116
13.20.0 Introduction.....	1022	Lab Type: Small Animal Procedure.....	1118
13.20.1 Standard Operating Procedures (SOP)	1023	Lab Type: Small Animal Holding.....	1120
13.20.2 Maintenance Program .....	1023	Lab Type: Optics.....	1122
13.20.3 Root Cause Analysis (RCA), and Corrective and Preventative Action (CAPA).....	1024	Lab Type: Microbiology.....	1124
13.20.4 Calibration.....	1024	Lab Type: Lab Supply Room.....	1126
13.20.5 Change Control .....	1024	Lab Type: Gowning BSL-3.....	1128
13.20.6 Documentation & Storage .....	1025	Lab Type: Electron Microscope .....	1130
13.20.7 Spare Parts and “Like for Like” Replacements .....	1026	Lab Type: Dark Room .....	1132

<b>Appendix G: Sample Equipment Schedule.....</b>	<b>1134</b>
<b>Appendix H: DRM Links .....</b>	<b>1136</b>
H.1 Links to References on the World Wide Web.....	1137
H.2 Links to Industry Associations .....	1137
H.3 Links to Code Agencies .....	1140
H.4 Links to Federal, State, and Local Agencies .....	1141
H.5 Links to Miscellaneous Publications and References .....	1141
<b>Appendix I: Abbreviations, Acronyms, and Units of Measure .....</b>	<b>1142</b>
<b>Appendix J: Lease Facilities DRM Checklist .....</b>	<b>1151</b>
<b>Appendix K: DRM Variance Form .....</b>	<b>1164</b>
<b>Appendix L: Sealant Table.....</b>	<b>1166</b>
<b>Appendix M: Interior Signage Manual.....</b>	<b>1172</b>
<b>Appendix N: High Purity and Animal Drinking Water System Sanitization, Lab Testing, and Acceptance .....</b>	<b>1182</b>
<b>Appendix O: Specialty Labs .....</b>	<b>1191</b>
Appendix O.1 Insect Facilities .....	1192
Appendix O.2 Electron Microscopes and Nanotechnology .....	1208
<b>Revisions</b>	
<b>Revision .....</b>	<b>1214</b>

# Chapter 1

---

# Administration



# Section 1.1

## General Administration

---

### Contents

#### 1.1.0 Introduction

#### 1.1.1 *DRM* General Information

##### 1.1.1.1 Organization

##### 1.1.1.2 Knowledge of *DRM*, Standards, and Interdisciplinary Coordination

##### 1.1.1.3 Amendments

##### 1.1.1.4 Distribution

##### 1.1.1.5 Application

##### 1.1.1.6 Facility Acquisitions

#### 1.1.2 Codes, Standards & Guiding Principles

##### 1.1.2.1 Requirements by Reference and Coordination Between Codes

##### 1.1.2.2 Guiding Principles from HHS as They Relate to the NIH *DRM*

##### 1.1.2.3 Compliance with Codes and Standards

## 1.1.0 Introduction

The National Institutes of Health (NIH) *Design Requirements Manual (DRM)* establishes policy, design requirements, standards, and technical criteria for use in planning, programming, and designing of NIH owned, leased, operated, and funded buildings and facilities as well as new additions or renovations to existing facilities. The standards provided within the *DRM* are applicable to all building types and facilities. To the greatest extent possible, the *DRM* provides standards that are performance oriented in order to achieve specific, desired results. All Architect-Engineering and Design-Build contracts and task orders awarded by the NIH shall comply with the *DRM*.

The organization, maintenance, distribution, and applicability of the *NIH DRM* is described in this section. This *Manual* supersedes all previous editions of the NIH Design Policy and Guidelines and editions of the *NIH DRM*.

This *Manual* is effective December 12, 2016.

The *DRM* was developed and is maintained by the Office of Research Facilities Development and Operations (ORFDO), henceforth called ORF, in partnership with architects and engineers involved with the design of NIH facilities. ORF's Division of Technical Resources (DTR), Standards and Policy Branch (SPB) facilitates this effort and can be contacted through the Project Officer (PO) to clarify questions regarding the contents of the *DRM*.

## 1.1.1 *DRM* General Information

### 1.1.1.1 Organization

**A. Sections:** The *DRM* consists of major subject categories broken into subsections detailing design requirements for NIH facilities.

**B. Exhibits and Appendices:** Exhibits and appendices are included in the *DRM*. Exhibits are located at the end of sections in which the exhibit is initially referenced. Appendices are located at the end of the *Manual*. Both the exhibits and the appendices include standards,

code references, design resources, checklists, forms, and general information that assist in developing complete designs.

**C. Linked Text:** For ease of reference, sections or portions of text of the *DRM* are linked to other sections within the *Manual* or to external websites as applicable.

### 1.1.1.2 Knowledge of *DRM*, Standards, and Interdisciplinary Coordination

**A. Requirements/Standards:** The Architect/Engineer (A/E) shall adhere to the requirements and standards of each section of the *DRM* and coordinate technical requirements amongst disciplines.

**B. Compliance by Other Disciplines:** Regardless of where specified or how constructed or supplied, the requirements of each section of the *DRM* apply to all devices and equipment connected to building systems. All devices and equipment shall be coordinated between specifiers to ensure conformance with the entire *DRM*, including specialty equipment and work of specialty vendors.

Compliance shall include all pertinent information on project drawings and specifications, and shall not reference the *DRM* for construction contractors to determine the work required.

*Rationale: It is often found that specialty equipment is not properly coordinated between disciplines or is not specified in a manner compliant with all requirements of the DRM. Examples include but are not limited to biological safety cabinets (BSC), fume hoods, washers, sterilizers, faucets, turrets, eyewashes, aftercoolers, disposers, gas supply systems, polishers, ventilated tables, or equipment of specialty vendors. Additionally, specialty equipment may impact infrastructure requirements and work of other disciplines.*

### 1.1.1.3 Amendments

**A. Changes:** Changes to the *DRM* will be issued by the SPB. The revision date shown on the front cover and within the Revisions section provides details on all updates.

**B. Feedback:** Users of this *Manual* are encouraged to submit proposed corrections, updates, and improvements to the SPB for consideration by contacting the Chief of Standards and Policy at [drm@mail.nih.gov](mailto:drm@mail.nih.gov).

**C. Proposed Changes:** It is the SPB's practice to solicit input on proposed changes from affected parties prior to publishing a change to the *DRM*. Where a *DRM* revision materially changes after a contract award or Notice to Proceed the contractor should request interpretation from the PO if any changes are required.

#### 1.1.1.4 Distribution

**A. Availability:** The *DRM* is a public document and is available at: <https://www.orf.od.nih.gov/PoliciesAndGuidelines/BiomedicalandAnimalResearchFacilitiesDesignPoliciesandGuidelines/Pages/DesignRequirementsManual2016.aspx>. The *DRM* is available to each PO, Contracting Officer (CO), and design contractor responsible for the planning and designing of NIH facilities. Compliance with NIH design guidelines and requirements outlined in this *Manual* is the responsibility of each NIH CO, PO, and design contractor.

#### 1.1.1.5 Application

The *DRM* is applicable to all projects in NIH owned and operated facilities or otherwise funded by the NIH.

NIH grantees should refer to their Grants Officer for application of the *DRM* to specific construction grants.

#### 1.1.1.6 Facility Acquisitions

Facility acquisitions are the purchase and/or lease of existing structures or facilities by the federal government. For owned facilities, the Architect/Engineer (A/E) shall determine during early planning what NIH life-expectancy projections are for the particular facility and design to that expectation. Any facility proposed for lease shall be evaluated for its capability to comply with the *DRM*. The CO, in consultation with DTR, shall decide the elements of the *DRM* applicable to the project based on the length of the lease and the purpose for which the space will be used.

## 1.1.2 Codes, Standards & Guiding Principles

### 1.1.2.1 Requirements by Reference and Coordination Between Codes

**A. References/Codes/Standards:** *DRM Section 1.2 Referenced Codes, Standards, and Organizations* lists reference documents that shall be used in conjunction with the *DRM*. All A/E work prepared for the NIH shall conform to all requirements and recommendations of the reference documents. Regulations, codes, and standards referenced in this *Manual* shall be considered part of the requirements of this *Manual* to the prescribed extent of each such reference. Where differences occur between provisions of this *Manual* and referenced codes and standards, the more stringent provision shall apply.

**B. Conflict:** Where there is a conflict between a general requirement and a specific requirement, the specific requirement shall be applicable. Where in any specific case different sections of this *Manual* specify different materials, methods of construction, or other requirements, the most restrictive shall govern.

### 1.1.2.2 Guiding Principles from HHS as They Relate to the NIH *DRM*

Investment decisions with regard to agency real-property assets need to be integrated with and supportive of core mission activities to effectively manage and optimize real-property assets. To facilitate integrating real-property-asset management decisions with the agency mission requires two elements – a clear understanding of the agency's mission that drives the allocation and use of all available resources (human, physical, financial, and technology/information capital) and an effective decision-making framework. HHS facilities shall be planned and delivered to best meet the functional, safety, and environmental needs of the programs and missions they house.

**A. Environmental and Functional Needs:** HHS buildings shall provide an environment in which occupants can perform their work with maximum efficiency and at the optimum level of comfort. Real-property-management decision making will support agency missions and strategic goals.

**B. Safety, Health, and Security:** HHS buildings shall provide an environment that is safe and healthy for occupants. To the greatest extent possible HHS buildings should provide occupants maximum protection during emergencies or disasters.

**C. Economy:** HHS facilities shall be planned and delivered based on life cycle-cost principles and sustained mission integrity. HHS will accurately inventory and describe all of its assets so full and appropriate utilization of space can be promoted. Life cycle cost-benefit analysis shall be employed to explore alternatives for satisfying new requirements.

**D. Conservation and Resources:** Energy and water conservation shall be given prime consideration in the planning and delivery of HHS facilities. Products, materials, and systems shall be selected with a view toward maximizing the use of renewable resources.

**E. Preservation of Historic and Cultural Resources:** Preservation shall be given full consideration in the planning and the delivery of HHS-controlled real-property assets and federally assisted undertakings.

**F. Sustainable Design:** The planning, acquiring, siting, designing, building, operating, and maintaining of HHS facilities shall take into consideration sustainable design principles including integrated design, energy performance, water conservation, and indoor environmental quality and materials.

### 1.1.2.3 Compliance with Codes and Standards

**A. A/E Compliance:** Each NIH building shall be constructed or altered in compliance with the codes and standards referenced herein. The A/E shall comply with the design and safety guidelines and references listed in [DRM Section 1.2 Referenced Codes, Standards, and Organizations](#) as well as other requirements received or directed from the PO or as specified by the program requirements. The A/E shall utilize the latest editions of referenced codes, standards, and design and safety guidelines available at the time of the project's Notice to Proceed. Where a code requirement materially changes after Notice to Proceed request interpretation from the PO if any changes are required.

**B. Conflict between Code and DRM:** In cases of conflict between the adopted or selected code or standard and the NIH DRM, the most stringent, technically appropriate, and conservative criteria shall apply. Where it is unclear which set of requirements is applicable, consult the Authority Having Jurisdiction (AHJ) for direction. Where it is unclear which criteria are to be applied, application for clarification may be made through the PO.

**C. Lesser Requirement:** In cases where the DRM specifically allows a practice lesser than that required under a national model code, an application for clarification should be made to the PO and the DTR.

***Rationale:** In some cases, a provision that appears less restrictive than a common practice may be required for reasons specific to the application in a laboratory, biocontainment, or research facility. These provisions may actually be a safer or more reliable option for such applications or more suitable to the means for which such systems are operated. In most cases, there will not be a conflict between a code requirement and the DRM. If a particular question or concern exists, an interpretation or guidance may be requested.*

**D. Zoning Laws:** Due consideration shall be given to all state and local zoning laws as if the project were not being constructed or altered by a federal agency.

**E. Permits/Inspections:** The U.S. Government and its contractors shall not be liable for the cost of issuing local building permits or performing inspections for NIH construction.

**F. Geographic/Local Issues:** The NIH main campus and headquarters is located in Bethesda, Maryland. The NIH has six additional field stations: Poolesville, Maryland; Baltimore, Maryland; Hamilton, Rocky Mountain Laboratories (RML), Montana; Research Triangle Park (RTP), North Carolina; Frederick, Maryland; and New Iberia, Louisiana.

Geographic requirements, local government mandates, and other unique geographic design criteria are not specifically mentioned in the DRM because the design shall comply with state and local regulations in addition

to *DRM* requirements. There may be specific issues in remote regions that are in conflict with the policies implemented by the NIH in Bethesda, Maryland. If this occurs, the more stringent policy shall apply. The A/E is required to check for site-specific requirements, starting with the regional office.

**G. Research Triangle Park:** Specific requirements at RTP that deviate from criteria in the *DRM* include:

1. County permitting
2. Interface with Division of Occupational Health and Safety (DOHS/ORS)

**H. Rocky Mountain Laboratories:** Specific requirements at RML that deviate from criteria in the *DRM* include:

1. Special bracing design for the seismic-zone designation
2. 100% standby-power versus load-shedding requirements
3. Special storm-water-management treatment due to gravel site
4. City-mandated special manhole requirements
5. City-mandated videotaping requirements
6. Unique traffic and noise standards
7. Historic core

# Section 1.2

## Referenced Codes, Standards, and Organizations

---

### Contents

**1.2.0 Introduction**

**1.2.1 Required Codes and Standards**

**1.2.2 Additional Guidance**

**1.2.3 Office of Research Facilities Development and Operations/Office of Research Services**

## 1.2.0 Introduction

The listed codes and standards in this section and referenced throughout this *Manual* shall be considered part of the requirements of this *Manual* to the prescribed extent of each such reference. In cases of conflict between the adopted or selected code or standard and the NIH *DRM*, the most stringent, technically appropriate, and conservative criteria shall apply. Where it is unclear which set of requirements is applicable, consult the Authority Having Jurisdiction (AHJ) or PO for direction.

There are numerous industry guidelines and standards that must be followed in concert with the *DRM*. The A/E shall be cognizant of all requirements of the *DRM* and its referenced documents. Projects in Maryland must comply with the Code of Maryland Regulations (COMAR) unless otherwise noted.

The most current edition of each Code and Standard shall be applicable as referenced throughout this document.

## 1.2.1 Required Codes and Standards

1. Code of Federal Regulations (CFR)
2. International Building Code (IBC)
3. International Mechanical Code (IMC)
4. International Plumbing Code (IPC) or Uniform Plumbing Code (UPC)
5. International Energy Conservation Code (IECC)
6. Architectural Barriers Act Accessibility Standard (ABAAS)
7. American National Standards Institute (ANSI)/ Building Owners and Managers Association (BOMA) Z65.1
8. National Fire Protection Association (NFPA) 1: Fire Code, and its mandatory referenced codes and standards
9. NFPA 101: Life Safety Code, and its mandatory referenced codes and standards
10. American Society of Heating, Refrigerating, and Air Conditioning Engineers (ASHRAE) Standard 62.1 Ventilation for Acceptable Indoor Air Quality
11. ASHRAE Standard 90.1 Energy Standard for Buildings Except Low-Rise Residential Buildings
12. ASHRAE Standard 189.1 Standard for the Design of High-Performance Buildings
13. ANSI/American Society of Mechanical Engineers (ASME) B31.1, B31.3 and B31.9
14. Food and Drug Administration (FDA) Good Manufacturing Practices
15. National Institutes of Health (NIH) Public Health Service Policy on Humane Care and Use of Laboratory Animals
16. Requirements of the Office of Laboratory Animal Welfare (OLAW)
17. American Veterinary Medical Association Guidelines
18. Guide for the Care and Use of Laboratory Animals (ILAR)
19. Centers for Disease Control and Prevention (CDC) & NIH Biosafety in Microbiological and Biomedical Laboratories (BMBL)
20. FDA Food Code
21. IEEE 802.11 Wireless LAN
22. ANSI/TIA-569 Telecommunications Pathways and Spaces
23. ANSI/TIA-568 Generic Telecommunications Cabling for Customer Premises
24. ANSI/TIA-1179 Healthcare Telecommunications Infrastructure Standard
25. TIA TSB-162 Telecommunications Cabling Guidelines for Wireless Access Points
26. TIA TSB-5018 Structured Cabling Infrastructure Guidelines to Support Distributed Antenna Systems



27. Guide for the Care and Use of Agricultural Animals in Research and Teaching
28. Federal Management Regulation (FMR)
29. ANSI Z358.1, Z9.5, Z9.11, Z9.14
30. FGI Guidelines for Design and Construction of Hospitals

16. Building Owners and Managers Association (BOMA)
17. Centers for Disease Control and Prevention (CDC)
18. Certified Ballast Manufacturers Association (CBM)
19. Concrete Reinforcing Steel Institute (CRSI)
20. Construction Specifications Institute (CSI)

## 1.2.2 Additional Guidance

The following organizations and agencies provide guidance documents which shall be followed as applicable.

1. Air Movement and Control Association (AMCA)
2. American Institute of Architects (AIA)
3. American Conference of Governmental Industrial Hygienists (ACGIH)
4. American Concrete Institute (ACI)
5. American Institute of Steel Construction (AISC)
6. American National Standards Institute (ANSI)
7. American Society of Civil Engineers (ASCE)
8. American Society of Heating, Refrigerating and Air Conditioning Engineers (ASHRAE)
9. American Society of Mechanical Engineers (ASME)
10. American Society of Plumbing Engineers (ASPE)
11. American Society of Sanitary Engineering (ASSE)
12. American Society of Testing Materials (ASTM)
13. American Welding Society (AWS)
14. American Water Works Association (AWWA)
15. Association for Assessment and Accreditation of Laboratory Animal Care (AALAC)

21. Collaborative Technology Innovation and Video Services Group (CTIVS)
22. Department of Energy (DOE)
23. Department of Health & Human Services (HHS)
24. Department of Transportation (DOT)
25. Electronic Industries Association (EIA)
26. Environmental Protection Agency (EPA)
27. Federal Communication Commission (FCC)
28. Food and Drug Administration (FDA)
29. General Services Administration (GSA)
30. International Code Council (ICC)
31. The Institute of Electrical and Electronics Engineers Inc. (IEEE)
32. Illuminating Engineering Society of North America (IESNA)
33. International Association of Plumbing and Mechanical Officials (IAPMO)
34. International Electrical Testing Association (IETA)
35. International Laboratory Accreditation Cooperation (ILAC)
36. Institute for Laboratory Animal Research (ILAR)
37. International Organization for Standardization (ISO)

38. International Society of Pharmaceutical Engineering (ISPE)
39. Lightning Protection Institute (LPI)
40. Maryland Department of Environment (MDE)
41. National Environmental Balancing Bureau (NEBB)
42. National Electrical Manufacturers Association (NEMA)
43. National Electrical Testing Association (NETA)
44. National Fire Protection Association (NFPA)
45. National Institute for Certification in Engineering Technologies (NICET)
46. National Institutes of Health (NIH)
47. National Institute of Occupational Health and Safety (NIOSH)
48. National Institutes of Standards and Technology (NIST)
49. National Sanitation Foundation (NSF)
50. National Science Foundation (NSF)
51. Nuclear Regulatory Commission (NRC)
52. Occupational Safety & Health Administration (OSHA)
53. Post Tensioning Institute (PTI)
54. Public Health Service (PHS)
55. Scientific Apparatus Makers Association (SAMA)
56. Sheet Metal and Air Conditioning Contractor's National Association (SMACNA)
57. Telecommunication Industries Association (TIA)
58. Washington Suburban Sanitary Commission (WSSC)
59. World Health Organization (WHO)

### 1.2.3 Office of Research Facilities Development and Operations/Office of Research Services

The following list provides the acronyms and contact information for NIH divisions commonly referred to in this document.

**DTR** – Division of Technical Resources, 301-435-8746

**DFP** – Division of Facilities Planning, 301-496-5037

**DEP** – Division of Environmental Protection, 301-496-3537

**DFS** – Division of Facilities Stewardship, 301-435-1654

**UEB** – Utilities Engineering Branch, 301-443-5585

**DFOM** – Division of Facilities Operations and Maintenance, 301-435-8000

**DOHS** – Division of Occupational Health & Safety, 301-496-2960

**DRS** – Division of Radiation Safety, 301-496-5774

**DFM** – Division of the Fire Marshal, 301-496-0487

**DPSM** – Division of Physical Security Management, 301-443-7287

**CIT** – Center for Information Technology, 301-496-4357

**OHPE** – Office of Hospital Physical Environment, 301-594-6472

**CCOFM** – Clinical Center Office of Facility Management, 301-496-2862

**DDCM** – Division of Design and Construction Management, 301-496-6186

# Section 1.3

## Definitions

---

### Contents

1.3.0 Introduction

1.3.1 List of Definitions

## 1.3.0 Introduction

Definitions of the terms used in this *Manual* and in the NIH facility design programs are provided in this section. These definitions will assist users of the *Manual* in understanding and properly applying certain terminology to the design process. These definitions and all other definitions in this *Manual* must be read in association with relevant definitions given in any other appropriate and applicable laws and regulations, and similar Government-wide requirements.

### 1.3.1 List of Definitions

**Adaptability:** Adaptability is the ability to adjust to changing conditions or requirements under both normal and emergency conditions. For example, the mechanical, electrical, and plumbing (MEP) systems should accommodate changes in ventilation rate, temperature, and power.

**Agency:** In very general terms, an administrative unit of government. A department operating division (OPDIV) is any of the agencies under the Department of Health and Human Services (HHS) that is responsible for the conception, planning, programming, budgeting, and/or execution of a program(s) and any associated operating functions.

**Alterations:** Improvements that consist of any betterment or change to an existing property to allow its use for a different purpose or function. See also the definition of [Improvements](#).

**Animal Research Facility (ARF):** A facility with specifically designed environments for the care and support of animals used for research. The ARF typically includes procedure rooms, cage wash and sanitation facilities, personnel support rooms and others directly related support functions.

**Architectural/Engineering (A/E) Services** (as defined in *40 USC 1102* and the Federal acquisition regulation [FAR]):

1. Professional services of an architectural or engineering nature as defined by state law that are required to be performed or approved by a person licensed, registered, or certified to provide such services.
2. Professional services of an architectural or engineering nature performed by contract that are associated with research, planning, development, design, construction, alteration, or repair of real property.
3. Such other professional services of an architectural or engineering nature, or incidental services that members of the architectural and engineering professions (and individuals in their employ) may logically or justifiably perform, including studies, investigations, surveying and mapping, tests, evaluations, consultations, comprehensive planning, program management, conceptual designs, plans and specifications, value engineering, construction-phase services, soils engineering, drawing reviews, preparation of operating and maintenance manuals, and other related services.

**As-Built Drawings:** Construction drawings revised to show all changes made during the construction process based on record drawings (marked-up prints, drawings, and other illustrations) furnished by the contractor to the Government.

**Aseptic Processing:** A process by which separate, sterile components (e.g., drugs, containers, or closures) are brought together under conditions that maintain their sterility. The components can either be purchased as sterile or, when starting with nonsterile components, can be separately sterilized prior to combining (e.g., by membrane filtration, autoclave). Literally, processing without addition of microbial contamination.

**Aseptic Production Facility (APF):** Facilities which produce drug and/or biologic products for human injection, implantation, ingestion, inhalation, or absorption. This includes facilities where non-aseptic products are produced using aseptic practices.

**Authority Having Jurisdiction (AHJ):** An organization, office, or individual responsible for enforcing the requirements of a code or standard, or for approving equipment, materials, an installation, or a procedure.

**Barrier Facility:** Facilities that are designed and constructed to ensure isolation and prevent introduction of outside infectious agents in areas where animals of a defined health status are housed and used. A barrier is a systematic, comprehensive program for the prevention

of pathogen contamination. The intent of a barrier facility is to protect the animals not the lab workers. Barriers in the context of animal facility design consist of a combination of physical systems and performance criteria that together minimize the transfer of etiologic agents of animal or human disease from one side of the barrier to the other.

**Base Year:** The base year is the first year of the value engineering study period. See [Section 1.7 Value Engineering](#).

**Basic Services:** The services performed by an A/E during a project.

**Basis of Design (BOD):** The BOD serves to document the parameters of the project, the design intent, and decisions made during the design process. Like drawings and specifications, the BOD is an important permanent record of the building design. The BOD includes narratives, which explain and document all important requirements and decisions made during the design process, Statement of Work (SOW), project program, code summary and analysis, room data sheets, equipment schedule, and equipment cut sheets. Depending on the scope of the project, other items may include cost estimates, geotechnical and survey information, planning alternatives, questionnaires and surveys, studies, benchmarking, sustainability goals and approach, and other information that will provide insight and background on the project and its development.

**Beneficial Occupancy:** Beneficial occupancy takes place on the date when part or all of the work involved in a construction project is substantially complete and the Government takes possession of the designated space or spaces to use for the purpose intended. Beneficial occupancy also initiates the warranty period and any additional environmental mitigation identified in the environmental documents. (The use of a project or portion thereof for the purpose intended.)

**Biosafety Levels:** Biosafety levels are defined in the Centers for Disease Control (CDC)/NIH publication, *Biosafety in Microbiological and Biomedical Laboratories*. DRM requirements are for Biosafety Level 1, 2, and 3 laboratories. The biosafety levels consist of combinations of laboratory practices and techniques, safety equipment, and laboratory facilities. Each combination is specifically appropriate for operations performed for the documented

or suspected route of transmission of infectious agents.

**Biosafety Level 1:** Practices, safety equipment, and facility design and construction are appropriate for work with defined and characterized strains of viable microorganisms not known to cause disease in healthy adults.

**Biosafety Level 2:** Practices, safety equipment, and facility design and construction are appropriate for work with a broad spectrum of indigenous moderate risk agents that are present in the community and associated with human disease of varying severity.

**Biosafety Level 3:** Practices, safety equipment, and facility design and construction are appropriate for work with indigenous and exotic agents with a potential for respiratory transmission and which may cause serious and potentially lethal infection. At Biosafety Level 3, more emphasis is placed on primary and secondary containment to protect personnel in contagious areas, the community, and the environment from exposure to potentially infectious aerosols.

**Certification:** The systematic review of all safety features and processes associated with the laboratory to validate that all facility controls and prudent practices are in place to minimize, to the greatest extent possible, the risks associated with laboratory operations and the use of hazardous materials.

**Classified Space:** Areas where HVAC systems are specifically designed to reduce airborne contaminants below a specified Level (as defined in ISO classes) and both temperature and relative humidity (RH) are controlled more tightly than in the ambient environment. These areas must be performance verified/qualified.

**Cleanroom:** A specially constructed room in which the air supply, air distribution, filtration of air supply, materials of construction, and operating procedures are regulated to control airborne particle concentrations to meet appropriate cleanliness levels and other relevant parameters (i.e., temperature, humidity, pressure, etc.) as defined in ISO classifications or any other regulatory entity.

**Commissioning (Cx):** The process of ensuring all building systems are working before occupants move in. It involves making sure all systems are installed properly and perform according to design, are cost-effective, meet the users' needs, are adequately documented, and

are well understood by the systems' operators.

**Concepts:** Drawings, sketches, and/or graphics showing alternatives used to define a project's scope during the programmatic phase of the project.

**Constructed Asset:** A constructed asset is received as equipment, materials, services, and supplies and built to its final, functioning form that is not available "off the shelf" but is built or constructed to unique specifications. The acquisition cost of a constructed asset is the total of all costs (equipment, materials, services, supplies, freight, salaries, benefits, overhead, etc.) incurred in the process of designing and building the asset.

**Construction:** The erection of a building, structure, or facility that provides space not previously available, including site preparation, landscaping, associated roads, parking, environmental mitigation and utilities, and the installation of equipment. It includes freestanding structures, additional wings or floors, enclosed courtyards or entryways, and any other means to provide usable space that did not previously exist (excluding temporary facilities). Construction projects are capitalized in accordance with the accounting principles of the Federal Accounting Standards Advisory Board (FASAB).

**Construction Codes:** Any set of standards set forth in regulations, ordinances, or statutory requirements of a local, state, or Federal Government unit relating to building construction and occupancy, adopted, administered, and enforced for the protection of the health, safety, and welfare of the public and the environment.

**Construction Documents Phase:** The third phase of the architect-engineer's basic services. In this phase the architect-engineer prepares the working drawings and specifications and necessary bidding information for approval by the Government.

**Construction Management:** A professional service that applies effective management techniques to the planning, design, and construction of a project from inception to completion for the purpose of controlling time, cost, and quality as defined by the Construction Management Association of America (CMAA).

**Construction Manager:** A person, firm, or business organization with the expertise and resources who has the responsibilities for coordination and accomplishment of overall project planning, design, and construction under contract to the Government.

**Containment Laboratory:** A laboratory employing engineering controls and administrative protocols for managing infectious materials. The purpose of containment is to reduce or eliminate exposure to laboratory workers, other persons, and the outside environment to potentially hazardous agents.

**Contract (As defined by FAR):** A mutually binding legal relationship obligating the seller to furnish the supplies or services (including construction) and the buyer to pay for them. It includes all types of commitments that obligate the Government to an expenditure of appropriated funds and that are in writing, except as otherwise authorized (by the FAR). In addition to bilateral instruments, contracts include, but are not limited to awards and notices of awards; job orders or task letters issued under basic ordering agreements; letter contracts; orders, such as purchase orders, under which the contract becomes effective by written acceptance or performance; and bilateral contract modifications.

**Contract Documents:** Those documents that comprise a contract, e.g., in a construction contract, the Government contractor agreement: Standard Form 252; general provisions and clauses; special contract requirements; other provisions in the uniform contract format; specifications, plans, and/or drawings; all addenda, modifications, and changes thereto; together with any other items stipulated as being specifically included.

**Contracting Officer (CO):** An individual who has the authority to execute a contract on behalf of the Government. This individual is the sole authorized agent in dealing with the contractor. The CO has authority to negotiate and execute contracts on behalf of the Government and to make changes, amendments, approve payments, terminate contracts, and close out contracts upon satisfactory completion.

**Contractor:** The person, firm, or corporation with whom the Government has executed a contract that is responsible for performing the work.

**Cost-Benefit/Cost-Effectiveness Analysis:** A cost-benefit/cost-effectiveness analysis is a mechanism to determine the best solution to satisfy facility requirements by exploring and comparing the economics of alternatives such as leasing, constructing a new facility, renovating an existing structure, or adding or altering a facility.



**Decommissioning:** All work required resulting in a facility free of chemical, biological, radiological, or other hazardous materials; and prepares the area for reasonable, unrestricted demolition.

**Decontamination (Decon):** The removal of biological agents or hazardous materials to render an area, device, item, or material safe (i.e., safe in the context of being reasonably free from a risk of disease transmission and bodily harm due to toxic chemicals, materials, and radioisotope contamination). This includes the neutralization and cleaning out of acid and corrosive materials; and the removal, destruction, or neutralization of toxic, hazardous, or infectious substances.

**Defective Work:** Work not in conformance with the contract documents. Materials and equipment furnished under the contract are not of specified quality and new unless otherwise required or permitted by the contract documents.

**Deficiency (As defined by FAR):** A material failure of a proposal to meet a Government requirement or a combination of significant weaknesses in a proposal that increases the risk of unsuccessful contract performance to an unacceptable level.

**Deliverables:** All of the drawings, specifications, models, etc., prepared in response to an awarded contract. For most construction projects this includes but is not limited to all of the record drawings, conformed specifications, operations and maintenance manuals delivered by the contractor prior to beneficial occupancy.

**Design-Bid-Build (As defined by FAR):** The traditional delivery method where design and construction are sequential and contracted for separately with two contracts and two contractors.

**Design-Build (As defined by FAR):** Combines design and construction in a single contract with one contractor.

**Design Development Phase:** The second phase of the A/E's basic services. In this phase, the A/E continues development of drawings and other documents illustrating the scale and relationship of project components for approval by the Government.

**Durability:** Durability is the ability to resist weathering, chemical exposure, abrasion, impact, and other conditions of ordinary service for a cost-effective life span or expected use, while undergoing ordinary maintenance

such as washing and sanitizing with appropriate cleansers. Life expectancy, expected use, and life cycle costs will vary depending on the type of facility, the geographic location, and whether the facility is owned or leased in addition to other factors such as maintenance, and materials and equipment quality.

**Equipment:** Tangible property having a useful life of more than one year and is used in business operations. See below for types.

1. **Fixed Equipment:** Fixed, built-in, attached, and installed equipment normally included as part of the construction contract and capitalized as facility cost.
2. **Moveable Equipment:** Equipment that does not require attachment to the building or utility service, other than that provided by an electrical plug or disconnect fittings.
3. **Special Purpose Equipment:** Technical, medical, or scientific equipment that is needed to operate a laboratory, a hospital, a clinic, a clinical research patient care unit, an animal care facility, or is specific to a single purpose and not generally suitable for other purposes. Special purpose equipment may be classified as either fixed or moveable equipment.

**Expandability:** Expandability is the ability to enlarge at minimal cost. Expandability refers to expanding within set boundaries of a facility by demounting walls or by expanding the building footprint.

**Facility:** A building or group of buildings, a structure, utility system, the building(s) site, and/or associated environs.

**Facilities Manager:** The person in each NIH operating division responsible for managing the facilities program.

**Facility Project Budget:** A summary of all estimated and projected costs for a construction, improvement, or repair project including costs associated with the project's planning, design, construction, facility activation, and equipment resulting in a fully operational facility.

**Fast Track Construction:** A scheduling process in which design and construction activities overlap. Design documents and equipment and trade subcontracts are released incrementally or in phases.



**Feasibility Study:** A detailed investigation and analysis conducted to determine the financial, economic, technical, environmental and other advisability of a proposed project.

**Federal Acquisition Regulation (FAR):** The basic policy governing Federal agency acquisitions. The FAR contains legal requirements, regulations, and policies that bear on contracting.

**Final Inspection:** Final review of the project by the Government to verify satisfactory completion of all contract elements, prior to issuance of the final payment.

**Flexibility:** Flexibility allows multiple choices or will accommodate future program changes. Flexibility includes adaptability, versatility, interchangeability, and expandability.

**Funds Invested (as Related to Value Engineering (VE)):** Estimates should include salaries and overhead expenses of VE, training costs for contracting for VE services, VE proposal development and implementation costs, and any other costs directly associated with the VE program.

**General Contractor:** The prime contractor who is responsible for all of the work at the construction site defined within the contract, including that performed by all subcontractors.

**General Provisions:** The standard clauses that are used by Government agencies in various types of contracts. Most of these clauses are set forth in FAR 52, and guidance for their use is set forth in the Provision and Clause Matrix in FAR Part 52.301. The term also includes clauses specified in FAR Supplement for agency wide use. FAR 52.102-1 provides that general provisions will be incorporated by reference to the regulations “to the maximum practical extent” rather than by placing the full text of clauses in the contract document.

**General Services Administration (GSA):** Acting by or through the Administrator of General Services, or a designated official to whom functions have been delegated by the Administrator of General Services.

**Good Manufacturing Practice (GMP):** A system for ensuring that products are consistently produced and controlled according to quality standards. It is designed to minimize the risks involved in any pharmaceutical production that cannot be eliminated through testing the final product.

**Gross Area:** The total square footage/square meters in a building for all floors from the outside face of exterior walls, disregarding such architectural projections as cornices, buttresses, and roof overhangs. Gross area includes all research and administrative space, retail space, and other areas such as mechanical rooms, vending machine space, and storage. Gross area also includes major vertical penetrations such as shafts, elevators, stairs, or atrium space. This figure is used in defining construction costs for facilities.

**Historic Properties:** Properties listed on the National Register of Historic Places or determined by the Federal Preservation Officer in consultation with the cognizant State Historic Preservation Officer (SHPO) or Tribal Historic Preservation Officer (THPO) to be eligible for listing on the National Register of Historic Places based on National Register criteria.

**Improvements (Renovations/Alterations):** Any betterment or change to an existing property to allow its continued or more efficient use within its designated purpose (renovation), or for use for a different purpose or function (alteration). Building improvements also include improvements to or upgrading of primary mechanical, electrical, or other building systems, and site improvements not associated with construction projects. Improvements typically increase the useful life of a facility and are capitalized against the existing property in accordance with the accounting principles of the FASAB.

**ISO Class:** An air quality classification from the International Organization for Standardization, per ISO 14644-1 standards, which specify the cleanliness of spaces by airborne particulate via decimal logarithm of the number of particles 0.1  $\mu\text{m}$  or larger permitted per cubic meter of air.

**Laboratory:** A building, part of a building, or other place equipped to conduct scientific experiments, tests, investigations and research. These facilities are used directly in basic or applied research in the sciences including medicine and engineering.

**Latent Defect (As defined by FAR):** A defect that exists at the time of acceptance but cannot be discovered by a reasonable inspection.

**Lease:** Specific rights to real property that have been assigned to the Federal Government for a defined period of time.

**Life Cycle Cost (LCC):** The sum of all costs over the useful life of a building, system, or product including the costs of design, construction, acquisition, operation, maintenance, repairs, disposal, and salvage (resale) value, if any, using present worth costs. In the case of leased buildings, the life cycle cost shall be calculated over the effective remaining term of the lease.

**Liquidated Damages:** Liquidated damages usually are specified as a fixed sum per calendar day that the contractor must pay to the government for failure to complete the work within the time specified in the contract. Liquidated damages must be set at a level consistent with a reasonable forecast of actual harm to the Government. Additional information can be found in FAR Subpart 11.5 and 19.705-7.

**Maintenance:** Work to keep a property, facility, and/or building system or component in a continuously usable state or condition. Maintenance may include inspection, cleaning, calibration and adjustment, lubrication and replacement of constituent parts, materials and/or sub-assemblies worn, broken, damaged or otherwise compromised. Maintenance includes routine recurring work, which is incidental to everyday operations, as well as preventive work, which is programmed at scheduled intervals, and predictive work, which is indicated by analysis.

**Minor Renovations:** Renovations that are directly related to the installation of special-purpose equipment, as well as related design and inspection services. These renovations may include extending utility services, providing suitable safety and environmental conditions for proper operations, and making structural changes such as cutting walls and floors, and new partitions, provided such improvements are proximately incident to the installation, operation, and use of special purpose equipment and necessary to conduct the functions of the program(s). Minor renovation projects do not change the value of the underlying asset or increase the useful life of the facility.

**Model Building Codes:** Regional building codes adopted as law by local jurisdictions.

**Nationally Recognized Standard:** Encompasses any standard or modification thereof that:

1. Has been adopted and promulgated by a nationally recognized standards-producing organization under procedures whereby those interested and affected by it have reached substantial agreement on its adoption  
  
or
2. Was formulated through consultation by appropriate Federal agencies in a manner that afforded an opportunity for diverse views to be considered.

**Net Area or Net Space:** Refers to those portions of the facility available to use for program operations and for supply storage, building maintenance/operation, and other necessary support functions. Net area is measured from the inside of the permanent exterior wall to the near side of permanent walls separating the area from stairwells, elevators, mechanical rooms, permanent corridors, or other portions of the building not categorized as net space area in the Program of Requirements document. In calculating net area, no deduction is made for columns and projections that are necessary to the building. However, deductions shall be made for large duct and elevator shafts passing through it.

**Net Assignable Square Footage:** The area of a floor suite of rooms that is suitable for occupancy including secondary corridors. It excludes common or shared space that cannot be reasonably assigned for program purposes such as main egress corridors, hazardous waste marshaling areas on the loading dock, and other non-programmable space.

**Net Savings:** The net savings is the time-adjusted savings less time-adjusted costs taken over the study period.

**Offices:** Space which is primarily used for commercial, professional, or administrative work.

**Owned:** The Government has fee simple interest in the real property.

**Performance Specifications:** A specification expressed in terms of an expected outcome or acceptable performance standard.

**Pre-Project Planning:** Process for developing sufficient strategic information through which the NIH can address risk and determine required resources for successful construction projects.

**Prescriptive Specification:** The traditional method of specifying materials or techniques found in design bid-build projects. The range of acceptable products, manufacturers, and techniques, etc., is stipulated in detail to be followed by the builder.

**Program Justification Document (PJD):** One of the planning and programming documents that the NIH may develop for obtaining approval for the project and its scope, for identifying potential environmental impacts, and for developing a cost estimate for inclusion in the HHS budget. Generally, the PJD includes an Introduction, General Overview, Space and Occupancy Summary, Staffing Summary, and an Executive Summary. To form a Program of Requirements (POR), technical requirements are attached to the PJD.

**Program of Requirements (POR):** One of the planning and programming documents that the NIH may develop that describes the proposed facility. It includes estimates of design and construction costs, space requirements, environmental requirements, and other program information. Although normally developed by the NIH, resource availability and time constraints may dictate that the POR be developed by an A/E. Additional requirements for the POR are found in [Chapter 2](#).

**Project Definition Rating Index (PDRI):** A pre-project planning tool developed by the Construction Industry Institute (CII) that measures how complete the project scope has been defined. The PDRI score is required as part of the submission of the NIH facility project approval agreements (HHS-300).

**Project Officer (PO):** The Government representative legally designated by the CO as the authorized technical representative for administering the A/E, construction, and/or service contracts on behalf of the CO, exclusive of contractual matters. The PO is not authorized to issue any instructions or directions that affect any increases or decreases in the scope of work or that would result in the increase or decrease of the cost of the contract or a change in performance period of the contract.

**Public Area:** Any area of a building, which is ordinarily open to members of the public, including lobbies,

courtyards, auditoriums, meeting rooms, and other areas not assigned to a lessee or occupant.

**Public Body:** Any State of the United States, the District of Columbia, the Commonwealth of Puerto Rico, the Virgin Islands, or any political subdivision, agency, or instrumentality of the foregoing.

**Punch List:** A list of unsatisfactory or incomplete work items that are identified by government representatives during an inspection of the work after the contractor has notified the CO that work is substantially complete. The contractor must complete all punch list work items satisfactorily before the final acceptance of contract work.

**Real Property:** Any interest in land (together with the improvements, structures, and fixtures located thereon) under control of any Federal agency, except the public domain, or lands reserved or dedicated for national forest or national park purposes.

**Record Drawings:** The drawings submitted by a contractor or subcontractor at any tier to show the construction of a particular structure or work as actually completed under the contract.

**Renovation:** Improvements that consist of any betterments or changes to an existing property to allow its continued or more efficient use within its designated purpose. See also the definition of [Improvements](#).

**Rentable Area:** The square footage for which rent can be charged. Generally, it is the gross area of the full floor less the area of all vertical penetrations (elevator shafts, stairwells, mechanical shafts, etc.). Rentable area can be measured in many ways, but the most common measurement for office buildings is according to Building Owners and Managers Association (BOMA) standards.

**Repair:** The restoration of a failed or failing primary building system or real property facility component to a condition that restores its effective use for its designated purpose. A repair does not increase the underlying value of an existing facility and is typically not capitalized. An example of a primary building system would be the structural foundation and frame, domestic waste system, or building HVAC; a real property component would be a piece of the primary building system such as a roofing system, central chiller/boiler, generator, or elevators. A failed or failing primary building system or

real property component may be the result of action of the elements, fire, explosion, storm and/or other disasters, and by use near to or beyond its expected useful life or technical obsolescence.

**Risk Assessment:** The exercise of identifying, evaluating (probability versus consequence) and mitigating any potential hazard.

**Schematic Phase:** The first phase of the A/E's basic services. In this phase, the A/E prepares schematics consisting of drawings and other documents illustrating the scale and relationship of project components for approval by the Government.

**Scope of Work (Sometimes, referred to as "Scope" or SOW):** See [Statement of Work](#).

**Specific Pathogen Free (SPF):** SPF animals are animals that are free of defined germs and other infectious agents that may interfere with research. Areas (zones) where SPF animals are housed require design or operational features that minimize potential for cross contamination and maintain the sanitary environment. The veterinarians and the users of the facility will define the level of SPF.

**Specifications:** A part of the contract documents. A written document describing in detail the scope of work, materials to be used, method of installation, quality of workmanship for parcel of work to be placed under contract; usually utilized in conjunction with working drawings in building construction. Specifications can be described as proprietary, performance, prescriptive, or reference specifications. AIA Masterspec is the standard basis for specifications.

**Stakeholders:** Individuals and organizations that are involved in or may be affected by the undertaking of a project.

**Standards:** An approved model considered by an authority or by general consent as a basis of comparison. Standards tell the user how a procedure is commonly done and are usually regarded only as recommendations that do not have the force of law. Nationally recognized standards are frequently collected as reference information when codes are being prepared. In many instances, entire sections of the standards are adopted into the regulated codes and then become legally enforceable.

**Statement of Work (SOW):** The narrative description of a project including the physical size and characteristics, functions, and special features. The SOW is a document in the acquisition process that describes the work to be performed or the services to be rendered, defines the respective responsibilities of the Government and the contractor, and provides an objective measure so that both the Government and the contractor will know when the work is complete and payment is justified. Common elements of the SOW are background, project objectives, detailed technical requirements, deliverables, reporting, schedule, special considerations, and references.

**Substantial Completion:** The time when the contract work is complete to the point that the Government may take over the facility and receive beneficial occupancy for the purpose intended.

**Termination:** The unilateral cancellation of a contract by the Government for either: (a) convenience (in the best interest of the Government) or (b) default (failure of a contractor to perform as required).

**Turnkey:** A variation of design-build project delivery in which one entity is responsible to the owner for design, construction plus designated real estate services that may include project financing and site selection/purchase.

**Usable Square Footage:** The secured area (square footage) occupied exclusively by the tenant within the tenant's leased space. The usable area times the load factor for common area results in rentable area on which rent is charged. Usable area can be measured in many ways, but the most common measurement for office buildings is according to BOMA standards. It does not include restrooms, elevator shafts, fire escapes, stairwells, electrical and mechanical rooms, janitorial rooms, elevator lobbies, or public corridors (for example, a corridor leading from the elevator lobby to the entrance of a tenant's office).

**Validation:** (ISPE) Establishing documented evidence that a process or system, when operated within established parameters can perform effectively and reproducibly to produce a product meeting its predetermined specifications and quality attributes. Validation is establishing a documented evidence to provide a high degree of assurance that a specific system, process or facility will consistently produce a product meeting its predetermined specifications and quality attributes.

**Value Engineering (VE):** The formal technique by which contractors may (1) voluntarily suggest methods for performing more economically and share in any resulting savings, or (2) be required to establish a program to identify and submit to the Government methods for performing more economically without reduction in program requirements or quality. VE attempts to eliminate anything that increases acquisition, operation, or support costs, without impairing essential functions or characteristics. VE involves an organized effort to analyze alternative approaches for provision of systems, equipment, facilities, services, and supplies for the purpose of achieving the essential functions at the lowest life cycle cost consistent with required performance, reliability, quality, and safety.

**Value Engineering Change Proposal (VECP):** A proposal developed by a construction contractor under a VE clause in its construction contract that typically involves sharing in any resulting savings. The proposal normally involves changes in the drawings and specifications directed at reducing the construction costs or life cycle costs without impairing the project's essential functions or characteristics.

**Value Engineering Proposal (VEP):** As used, a VEP in connection with an A/E design contract, is a proposal for change developed by the A/E design firm, employees of the Government, or a specialized VE consulting firm. The proposal is similar to the VECP described above and is generally performed on a partially completed facility design. However, it is noted that there is no cost sharing of projected savings during the design phase.

**Versatility:** Versatility is the ability to rearrange items within a space. For example, use of modular components within a lab or animal facility allows for relatively easy change out due to a program change.

# Section 1.4

## Measurement of Space

---

### Contents

1.4.0 Introduction

1.4.1 Measurement Details & Calculations

1.4.1.1 Metric Standards for New Construction

1.4.1.2 Renovations and Additions

1.4.1.3 Leases

1.4.2 Net Assignable Area

1.4.3 Rentable Area



## 1.4.0 Introduction

This section outlines the means and methods to measure and describe space within a building as dictated by the NIH and HHS.

## 1.4.1 Measurement Details & Calculations

### 1.4.1.1 Metric Standards for New Construction

All final drawings and specifications for new construction shall be expressed in metric or dual units (metric and imperial), unless other requirements are specifically provided by the CO. The *General Services Administration (GSA) Metric Design Guide*, latest edition, and the *Metric Guide for Federal Construction* shall be used for guidance on how drawings, specifications, and other elements of metric implementation are to be addressed.

### 1.4.1.2 Renovations and Additions

All facility renovation and addition design projects shall be based on the unit type (i.e., metric or imperial) for which it was originally designed or constructed.

### 1.4.1.3 Leases

All lease facility design projects shall use English units in accordance with ANSI/BOMA Z65.1.

## 1.4.2 Net Assignable Area

Net assignable area (NAA) is the subset of the net area that is assigned to an NIH institute or center (IC) as program area and which the IC has control. NAA is measured and calculated the same as net area. It includes centrally managed conference rooms, cafes, and suite corridors that provide internal circulation and are not the main egress corridor for the floor. Prorated shared space such as autoclave rooms, ice rooms, waste management marshaling, and storage, is also included. NAA

excludes all interstitial space and common areas such as corridors, electrical rooms, elevator closets, housekeeping closets, local area network (LAN)/telephone closets, lobbies, locker rooms, mechanical rooms, storage rooms, switch rooms, toilet rooms, trash rooms, utility closets, vestibules, electrical wire closets, as well as laboratory break rooms, loading docks, lactation rooms, and other shared building amenities.

## 1.4.3 Rentable Area

Rentable area (RA) is calculated for a given IC by adding the IC's NAA and a percentage of the common areas based on the proportion of NAA the IC occupies in the building. This definition is used in charging rent. Rentable area is measured the same as net area. It is calculated as the NAA, plus:

1. The pro-rata share of common areas, such as public corridors, atrium usable floors, restrooms, break rooms, lobbies, LAN/telephone rooms, housekeeping closets, mechanical/electrical rooms, and loading docks
2. The pro-rata share of the NIH shared common spaces, which are excluded in the NAA
3. The pro-rata share of the mechanical space on interstitial floors

The sum of all tenant's rentable areas should equal the entire gross area of the building's floor(s) after deductions have been made for any major vertical penetrations. Typical efficiency ratio of NAA versus RA:

- a. Research space: NAA = ~ 50% of RA
- b. Administrative space: NAA = ~ 85% RA



# Section 1.5

## Project Design Review

---

### Contents

#### 1.5.0 Introduction

#### 1.5.1 Variance Request Procedures

#### 1.5.2 Design Submissions

#### 1.5.3 Roles and Responsibilities

##### 1.5.3.1 Architectural/Engineering Services

##### 1.5.3.2 Project Officer

##### 1.5.3.3 NIH Technical Review Staff

## 1.5.0 Introduction

In this section, general guidance is provided for reviewing projects during the design phase. This policy applies to federally owned real-property assets.

The NIH has the overall responsibility to provide Government oversight for the design of an NIH facility. The review process and the review comments from the Permit Review Board (PRB) and customer on the A/E design submittal are vital to the success of the project.

The A/E in Design-Bid-Build and Design-Builder in Design-Build projects is contractually responsible to design the project within the specified scope, budget, and schedule. The NIH shall ensure that the A/E fulfills its contractual responsibility to deliver a design of the approved HHS facility within scope, budget, and schedule.

Design content as well as other documents cited in the *DRM* are mandatory requirements. Variances from these requirements can only be granted by written requests that are reviewed and approved in accordance with [1.5.1 Variance Request Procedures](#).

Other information cited herein is based on the collective knowledge gathered over many years of experience in the design, construction, and operation of NIH biomedical research facilities and best practices learned from other institutions. The A/E shall follow the design guidance and information provided within all sections of the *DRM*. The A/E shall show cause in writing to justify deviation from these mandates and demonstration of equivalency.

### 1.5.1 Variance Request Procedures

**A. Alternative Designs:** The *DRM* provides standards that are performance oriented to the greatest extent possible. Prescriptive limitations, when given, such as exact dimensions or quantities, describe a condition that is commonly recognized as a practical standard or NIH requirement for effective operation. The provisions of this *Manual* are not intended to prohibit the use of alternative systems, methods, or devices that are not specifically outlined, provided that the proposed alternative design is at least equivalent or superior to the requirements in this

*Manual* with regard to such qualities as strength, durability, effectiveness, fire resistance, life cycle, flexibility, reliability, health and safety, etc., and is approved by the Division of Technical Resources (DTR) and other ORF and ORS divisions as applicable.

Variance Requests are project and location specific. Each project or location requires a separate Variance Request, and an approval granted for one project or location is not applicable to another project or location.

**B. Variance Requests:** During the course of programming and design development, it may become necessary for POs and the A/E to request variances from the requirements contained herein. These variances may be necessary to accommodate existing building constraints or site conditions, required technology, or the POR. A variance request form is provided in Appendix K. All completed variances will be reviewed by DTR staff. Requests for variances shall be submitted by the A/E through the PO following these procedures:

1. All requested variances within a single discipline shall be submitted as a single package (i.e., all mechanical in one package; all electrical in one package; etc.). This ensures that all variations to the guidelines can be reviewed at one time to preclude conflicts in guidance.
2. The A/E is responsible for submitting technical data as necessary to properly evaluate the deviation from *DRM* requirements. Technical data can consist of cut sheets, specifications, manufacturer's instructions, plans, etc. Not providing sufficient data for variance review may result in a delay of the variance review.
3. The A/E's requests for variances that meet the prescribed criteria will be considered for review by the DTR. If the submittal is incomplete, or requires resubmission, additional time may be required for the review. Submissions based on future variance approvals are at the A/E's risk. *A variance submission request does not guarantee variance acceptance. Acceptance of a variance does not relieve A/E of any responsibilities as a design professional.*
4. Following submittal of a complete package by the PO to the DTR, the review will take a minimum of 10 working days. Additional time may be necessary depending on the complexity of the request, coordination with other requests, or

resubmission due to incomplete documentation. This timeframe shall be considered by the A/E team when developing the overall project development schedule.

5. All known variances shall be submitted before the completion of the design development stage (35%) for a project. In some cases, the need for a variance may be the result of work done after the design development stage. Only in these cases will late variances be considered.

---

## 1.5.2 Design Submissions

The NIH determines the number of design submittals based on size and complexity of the project. The PO holds and chairs design review meetings with technical and program staffs at each specified design submittal stage. The A/E and the PO shall certify that the project is within the scope, schedule, and budget at each submittal. If a submittal is found to be deficient and does not meet contractual requirements, the Government must reject the submittal. The A/E will revise and resubmit the submittal at no additional cost to the Government and with no schedule extension to the overall project. See [Appendix E](#) for A/E submittal requirements. No construction may be started until the Government reviews the final design submission and determines it satisfactory for purposes of beginning construction.

---

## 1.5.3 Roles and Responsibilities

### 1.5.3.1 Architectural/Engineering Services

The A/E shall submit completed progress designs to the government for review and comment in accordance with the contract requirements. As a minimum, the A/E shall provide the following design submittals for projects exceeding \$5 million:

1. Schematic design
2. Design development
3. Construction documents

For projects with a cost of less than \$5 million, the PO shall determine the number of milestone design submittals and ensure that this is reflected in the design contract. The A/E shall not proceed to the next design phase until written approval of the current submittal is received from reviewers included during the Permit Review Board process.

### 1.5.3.2 Project Officer

The PO is the contact point for the Government, and as the Contracting Officer's Representative (COR), serves as the Government's authorized representative with respect to communicating and distributing comments to the A/E. The PO conducts and chairs design review meetings with NIH program and technical staff to evaluate design review comments. The PO, in consultation with the CO as well as appropriate ORF technical staff, shall determine if the review comments are within the scope of the A/E's contract.

### 1.5.3.3 NIH Technical Review Staff

The NIH will utilize senior design experts who have professional and technical experience in preparing contract documents to assist the PO in reviewing and evaluating the A/E's work.

#### Reviewing Offices:

- DTR – Division of Technical Resources
- DFP – Division of Facilities Planning
- DEP – Division of Environmental Protection
- DFS – Division of Facilities Stewardship
- DFOM – Division of Facilities Operations and Maintenance
- DOHS – Division of Occupational Health & Safety
- DRS – Division of Radiation Safety
- DFM – Division of the Fire Marshal
- DPSM – Division of Physical Security Management
- CIT – Center for Information Technology
- OHPE – Office of Hospital Physical Environment
- CCOFM – Clinical Center Office of Facility Management

# Section 1.6

## Project Cost Monitoring and Control

---

### Contents

1.6.0 Introduction

1.6.1 Programmatic Requirements

1.6.2 Cost Monitoring Procedures

1.6.3 Estimate Requirements

## 1.6.0 Introduction

This section provides guidance for monitoring project costs on federally owned real-property assets. When construction funding is submitted to the Office of Management and Budget (OMB) for inclusion of the Department's budget, the maximum project budget is considered to be fixed and linked to the project's scope. Reducing the scope to maintain budget limits is considered similar to a cost overrun.

### 1.6.1 Programmatic Requirements

Once submitted to HHS and under A/E design, programmatic changes and other requirements (i.e., growth) must be held to an absolute minimum; however, A/Es are encouraged to develop generic designs that are flexible and adaptable to deal with unexpected mission changes.

### 1.6.2 Cost Monitoring Procedures

A/E contracts must include FAR 52.236-22, Design Within Funding Limitations and be consistent with the HHS approved Facility Project Approval Agreement (FPAA). At a minimum, the A/E should submit a broad estimate (square meter cost) at the schematic level, a systems estimate at the design development level, and detailed quantity takeoff estimate at the contract document level.

If a submittal is found to be over the budget, the Government will reject the submittal. The A/E shall resubmit the submittal to bring it within the budget in accordance with the "Design within Funding" clause of its contract. The exceeded budget portion of the construction cost shall not be a basis for the A/E to claim an additional fee against the Government.

### 1.6.3 Estimate Requirements

The A/E shall design the project within the budget and shall provide a construction cost estimate at each scheduled design submission. The A/E shall provide a narrative description of the methodology used in the development of the estimate and if estimating software is used to produce the estimate, provide summary details of the software.

The following additional indirect cost items shall be shown as separate line items in detailed estimates:

1. Sub-Contractor overhead and profit
2. Prime Contractor markup on subs
3. Prime Contractor overhead and profit
4. Sales tax, State tax, Tribal fees (or tax), bonds and insurance
5. Escalation cost per year

The final estimate shall include detailed costs for all material, labor and equipment requirements. The final estimate shall not exceed the construction budget.

# Section 1.7

## Value Engineering

---

### Contents

- 1.7.0 Introduction
- 1.7.1 Design Contract Value Engineering Procedures
- 1.7.2 Construction Contract VE Procedures
- 1.7.3 VE Regulations
- 1.7.4 VE in Research Facilities

## 1.7.0 Introduction

This section provides policies and procedures for value engineering (VE) in architectural/engineering (A/E) services and construction contracts for federally owned HHS real-property assets. VE is mandatory for projects where the construction cost is \$1 million or greater. (See Office of Management and Budget, OMB circular A-131). All projects developed using Design-Build that are procured using full and open competition and are awarded based on a best-value-selection process are exempt from further VE. HHS requires an independent VE analysis by a specialized consultant or Government personnel for projects with a total project cost of \$10 million or more.

Value engineering activities are facilitated by the NIH designated Value Engineering Coordinator (VEC). The CO, in consultation with the VEC, is responsible for determining which contracts are subject to VE and for accepting or rejecting VE proposals.

### 1.7.1 Design Contract Value Engineering Procedures

**A. Sustainable Design Features:** Integration of sustainable design features into construction projects is mandated by law, regulation, executive order, and policy. Specific goals are established in planning and early design phases of every project. Many sustainability goals have benefits in that they reduce external environmental impacts without providing direct benefit to the project in terms of cost or performance. When sustainable design features are being evaluated during the VE process, consideration must be given to these benefits in addition to all costs including but not limited to direct/indirect, design and maintenance costs, etc., overall project budget limitations, durability and performance considerations and their integration throughout the overall design.

**B.** The value engineering analysis shall be done at the end of schematic design phase or no later than the midpoint of the design development phase. In addition the VE team shall include a certified value specialist team leader and A/E professionals with VE training and experience. When projects meet the thresholds for VE, the VEC should proceed as follows:

1. In conjunction with the CO, determine the scope of VE analysis to be undertaken, considering the size and type of the project, and document to the contracting file.
  2. Appoint a VE team. The VE team shall consist of members with expertise in the areas or disciplines to be reviewed for the project.
  3. Upon completion of analysis, file a VE report.
  4. Maintain copies of VE proposals and supporting documentation in the contracting file.
- C.** The following information shall be included in each Value Engineering Proposal (VEP) whether done by the A/E, specialized consultant, or Government personnel:
1. **Description and Comparison:** A description of the difference between the existing and proposed design, the advantages and disadvantages of each, a justification when an item's function is being altered, the effect of the change on the system's or facility's performance, and any pertinent objective test data. This may include but is not limited to sketches, calculations, models, etc.
  2. **Specifications:** A list and analysis of design criteria or specifications that must be changed if the VEP is accepted.
  3. **Project Cost Impact:** A separate detailed estimate of the impact on the project cost of each VEP, if accepted and implemented by the Government.
  4. **Implementation Costs:** A description and estimate of costs the Government may incur in implementing the VEP, such as design change cost and test and evaluation cost.
  5. **Life Cycle Costs:** A prediction of any effects the proposed changes may have on life cycle cost.
  6. **Benefit Analysis:** A description of the impact of each VEP on the affected NIH division or Institute/Center and its ability to perform its mission.
  7. **Sustainable Design Impact:** A description of the impact on sustainable design features, established sustainability goals, or third-party certification.



8. **Schedule Impact:** The effect the VEP will have on design or construction schedules.

---

## 1.7.2 Construction Contract VE Procedures

**A. General:** FAR Part 48 requires the CO to include a VE clause in construction solicitations and contracts when the contract amount is estimated to exceed the simplified acquisition threshold (\$150,000), unless an incentive contract is contemplated or the agency has granted an exemption. The CO may include a VE clause in construction contracts of lesser value, if the CO sees the potential for significant savings.

**B. Sustainable Design Features:** Value Engineering Change Proposals (VECP) that negatively impact sustainable design features needed to comply with EISA 2007 and Executive Order 13693 shall not be permitted unless they incorporate alternate provisions that achieve established sustainability goals and third-party certifications.

**C. Documentation:** As a minimum, each VECP submission from the contractor shall include the documentation required under FAR Part 48.

**D. The VECP:** The NIH CO, PO, and appropriate ORF technical staff will review and objectively evaluate each VECP, and document the contract file with the rationale for acceptance or rejection of the VECP. If a VECP is accepted, the Government and the contractor shall share the savings as prescribed in FAR Part 48.

## 1.7.3 VE Regulations

Below is a list of the primary federal regulations governing value engineering for HHS projects:

1. OMB Circular A-131, Value Engineering
  2. FAR Part 48
  3. 10 CFR 436 Subpart A – Life Cycle Cost Methods and Criteria Contained in the Federal Energy Management Program (FEMP) Rules
- 

## 1.7.4 VE in Research Facilities

VE is an organized effort directed at analyzing designed building features, systems, equipment, and material selections for the purpose of achieving essential functions at the lowest life cycle cost consistent with required performance, quality, reliability, and safety. In research facilities safety of staff, animals, and research takes a critical role. Special care should be taken during the VE process to ensure consequences of all VE decisions are fully understood. Involvement of all project stakeholders is critical in VE decisions. The VE team must fully understand the design intent of each system and potential risks involved in making changes to a project's design. Further, if a risk assessment has been performed it should be used as a critical guiding document.

# Section 1.8

## Sustainable Design

---

### Contents

1.8.0 Introduction

1.8.1 Principles

1.8.2 Sustainability Policy

1.8.2.1 HHS Guiding Principles for New Construction,  
Major Renovations, and Leases

## 1.8.0 Introduction

This section covers NIH requirements for incorporating sustainable features into NIH projects. In alignment with its mission to enhance health and lengthen life, and in accordance with Federal and HHS policies and requirements, the NIH is committed to sustainable facilities. All NIH facilities shall be designed, built, and operated sustainably and responsibly, with the goals of limiting the impact on the environment and enhancing the lives of occupants.

To promote the health of the public and our employees and minimize potential impacts of our mission activities on the environment, each project will incorporate sustainable and high-performance design principles in the planning, acquiring, siting, designing, building, operating, maintaining, and decommissioning of all facilities.

Several policies and laws affecting facilities have been issued that promote and mandate the greening of the Government. The design therefore shall provide for the protection of the environment through energy-efficiency, recycling, pollution prevention, and affirmative procurement.

The policy for sustainable and high performance buildings applies to all buildings under the control of the NIH, including all buildings that are reported in the HHS Automated Real Property Inventory System (ARIS), whether owned or leased and operated by HHS, or operated on behalf of HHS. This policy does not apply to tribally owned and operated buildings under the authorities of Public Law (P.L.) 93-638, Indian Self-Determination and Education Assistance Act, as amended.

---

### 1.8.1 Principles

**A. Goals:** Comprehensive sustainability goals, appropriate for the size and scope of the project, shall be defined prior to the initiation of design. The sustainability goals for projects above a set threshold will require LEED, Green Globes, or other third-party certification, as required by Federal and HHS policies and requirements. Projects of all sizes should pursue sustainability goals to the maximum extent feasible.

**B. Basis of Design Report:** The initial basis of design (BOD) report submission will define these goals and the strategies that will be taken to achieve them. Subsequent BOD submissions will include certification checklists, energy models and calculations, and other items necessary to document the achievement of sustainability goals.

**C. Comprehensive Approach:** Sustainability shall be approached as a comprehensive, multidisciplinary endeavor, beginning in predesign and extending through commissioning, occupancy, and operation. Sustainability should imbue all facets of a facility with integrated systems that are innately protective of the environment and healthy for building occupants. Key aspects of sustainable design include:

1. **Integrated Design:** Integrated design is an approach to high-performance building design and construction in which every member of the project team shares the common goal of sustainability, and works together to implement sustainable strategies throughout the project. Integrated design maximizes synergies among building components, resulting in reduced life cycle costs and increased efficiencies.
2. **Commissioning (Cx):** Commissioning is a process that verifies the performance of building components and systems, and ensures that design requirements are met. This requires a designated commissioning authority, inclusion of commissioning requirements in the construction documents, a commissioning plan, verification of the installation of systems to be commissioned, and a commissioning report.
3. **Optimized Energy Performance:** Optimized energy performance begins with establishing a facility performance goal that may include a targeted reduction below ASHRAE or other baseline. Energy models are used to test performance, including alternate HVAC systems, building orientations, building enclosure systems, energy recovery and renewable energy generation. Systems are selected based on optimal energy performance for the specific parameters of the project.
4. **Conserve and Protect Water:** Conserving water and protecting water quality are key objectives in sustainable design. Reducing consumption is

achieved by increasing the efficiency of fixtures and water-using systems reuse of water and the reduction of waste. Water quality is protected by managing runoff and elimination of hazardous materials from water systems.

5. **Enhance Indoor Environmental Quality:** Indoor environmental quality directly impacts the health and comfort of occupants, including ventilation and air quality, thermal comfort, moisture control, lighting (including daylighting), views, contaminants, acoustics and aesthetics. Environmental quality control begins with good practices during construction, and includes material and finish selection, occupancy, and operation.
6. **Reduce Environmental Impact of Materials:** The environmental impact of materials is reduced by specifying products which are non-toxic or non-ozone depleting, with maximum recycled content, renewable, and sustainable sources. During construction, environmental impact is reduced by recycling to the greatest extent possible.

---

## 1.8.2 Sustainability Policy

**A. General:** All construction projects will incorporate the Guiding Principles of the Federal Leadership in High-Performance and Sustainable Buildings Memorandum of Understanding (MOU) into the planning, design, construction, operation, maintenance, and decommissioning processes. Existing facilities will incorporate the Guiding Principles of the MOU to the maximum extent feasible in all improvement, repair, and maintenance projects. All projects shall also meet sustainability guidance as issued by HHS.

**B. Guiding Principles of the MOU:** In addition to incorporating the Guiding Principles of the MOU, all projects shall verify with current HHS policy whether the total project cost or area impacted necessitates obtaining certification from the U.S. Green Building Council's Leadership in Energy and Environmental Design (LEED) or the Green Building Initiative's Green Globes System.

**C. Compliance:** In addition, existing buildings shall be assessed for compliance with the Guiding Principles of the MOU to ensure that 15% or more of the HHS capital asset building inventory incorporates the sustainable practices in the Guiding Principles. The HHS capital asset building threshold for incorporating sustainable practices in existing buildings is 5,000 gross square feet or more, excluding housing.

**D. New Leases:** All new lease actions 5,000 usable square feet or more will incorporate the Guiding Principles of the MOU to the maximum extent feasible. New lease actions under 5,000 useable square feet will consider the Guiding Principles as one criterion for lease evaluation. A build-to-suit lease will be a LEED certified building.

**E. Waivers:** NIH cannot waive any requirements mandated by Executive Order 13693.

**F. Grants:** To the maximum extent feasible, sustainable design practices shall be considered in the design requirements for facilities funded through extramural construction grants.

### 1.8.2.1 HHS Guiding Principles for New Construction, Major Renovations, and Leases

#### 1.8.2.1.1 Employ Integrated Design Principles

**A. Integrated Design:** Use a collaborative, integrated planning and design process that initiates and maintains an integrated project team in all stages of a project's planning and delivery; establish performance goals for siting, energy, water, materials, and indoor environmental quality along with other comprehensive design goals; ensure incorporation of these goals throughout the design and life cycle of the building; and consider all stages of the building's life cycle, including deconstruction.

**B. Commissioning:** Employ total building commissioning practices tailored to the size and complexity of the building and its system components to verify performance of building components and systems and help ensure that design requirements are met. This should include a designated commissioning authority who is brought in at the early design phase of a project, inclusion of commissioning requirements in construction documents, a commissioning plan, verification of the

installation and performance of systems to be commissioned, and a commissioning report.

#### 1.8.2.1.2 Optimize Energy Performance

**A. Energy-Efficiency:** Establish a whole building performance target that takes into account the intended use, occupancy, operations, plug loads, other energy demands, and design to earn the ENERGY STAR targets for new construction and major renovation where applicable. For new construction, reduce the energy use by 30% compared to the baseline building performance rating per the American Society of Heating, Refrigerating and Air Conditioning Engineers (ASHRAE) and the Illuminating Engineering Society of North America (IESNA) Standard 90.1, Energy Standard for Buildings Except Low-Rise Residential. For major renovations, reduce the energy use by 20% below prerenovations 2003 baseline. If available ENERGY STAR and FEMP-designated energy-efficient products shall be used.

Per the Energy Independence and Security Act (EISA) Section 523, meet at least 30% of the hot water demand through the installation of solar hot water heaters when life cycle cost-effective.

**B. Measurement and Verification:** Per the Energy Policy Act of 2005 (EPA) Section 103, install building-level utility meters in new major construction and renovation projects to track and continuously optimize performance. Per Energy Independence and Security Act of 2007 (EISA) Section 434, include meters for steam, electricity, chilled water, domestic water and natural gas and steam, where appropriate.

Compare actual performance data from the first year of operation with the energy design target. After one year of occupancy, measure all new major installations using the ENERGY STAR Portfolio Manager for building and space types covered by ENERGY STAR. For other building and space types, use an equivalent benchmarking tool.

#### 1.8.2.1.3 Protect and Conserve Water

**A. Indoor Water:** Employ strategies that in aggregate use a minimum of 20% less potable water than the indoor water use baseline calculated for the building, after meeting the EPA 1992, Uniform Plumbing Codes, and the International Plumbing Codes fixture performance requirements. This is a requirement of the

Guiding Principles. Executive Order 13693 extended the 2% per year reduction through 2025 for a total of 36% by the end of FY 2025.

**B. Water Meters:** The installation of water meters is encouraged to allow for the management of water use during occupancy.

**C. Outdoor Water:** Use water efficient landscape and irrigation strategies, including water reuse and recycling, to reduce outdoor potable water consumption by a minimum of 50% over that consumed by conventional means (plant species and plant densities). The installation of separate water meters to segregate potable water from landscaping for locations with significant outdoor water use is encouraged.

**D. Storm Water Runoff:** Employ design and construction strategies that reduce storm water runoff and polluted site water runoff. Per EISA Section 438, to the maximum extent feasible, maintain or restore the predevelopment hydrology of the site with regard to temperature, rate, volume, and duration of flow using site planning, design, construction, and maintenance strategies.

**E. Process Water:** Per the EPA Section 109, when potable water is used to improve a building's energy-efficiency, deploy life cycle cost-effective water conservation measures. Once-through domestic water shall not be used in lieu of process water.

**F. Water Efficient Products:** Comply with the requirements of the *DRM* and use water-conserving products. Choose irrigation contractors who are certified through a WaterSense-labeled program.

#### 1.8.2.1.4 Enhance Indoor Environmental Quality

**A. Ventilation and Thermal Comfort:** Meet ASHRAE Standard 55, Thermal Environmental Conditions for Human Occupancy, including continuous humidity control within established ranges per climate zone, and ASHRAE Standard 62.1, Ventilation for Acceptable Indoor Air Quality.

**B. Moisture Control:** Establish and implement a moisture control strategy for controlling moisture flows and condensation to prevent building damage and mold contamination.

**C. Daylighting:** Achieve a minimum daylight factor of 2% (excluding all direct sunlight penetration) in 75% of all space occupied for critical visual tasks. Provide automatic dimming controls or accessible manual lighting controls, and appropriate glare control.

**D. Low-Emitting Materials:** Specify materials and products with low pollutant emissions, including adhesives, sealants, paints, carpet systems, and furnishings.

**E. Protect Indoor Air Quality (IAQ) during Construction:** Follow the recommended approach of the latest edition of the Sheet Metal and Air Conditioning Contractor's National Association Indoor Air Quality Guidelines for Occupied Buildings under Construction. After construction and prior to occupancy, conduct a minimum 72 hour flush-out with maximum outdoor air consistent with achieving relative humidity no greater than 60%. After occupancy, continue flush-out as necessary to minimize exposure to contaminants from new building materials.

#### 1.8.2.1.5 Reduce Environmental Impact of Materials

**A. Recycled Content:** For U.S. Environmental Protection Agency (EPA) designated products, use products meeting or exceeding EPA's recycled content recommendations. For other products, use materials with recycled content such that the sum of postconsumer recycled content plus one-half of the preconsumer content constitutes at least 10% (based on cost) of the total value of the materials in the project. If EPA-designated products meet performance requirements and are available at a reasonable cost, a preference for purchasing them should be included in all solicitations relevant to construction, operation, maintenance of, or use in the building.

**B. Biobased Content:** For USDA-designated products, use products meeting or exceeding USDA's biobased-content recommendations. For other products, use bio-based products made from rapidly renewable resources and certified sustainable wood products. If these designated products meet performance requirements and are available at a reasonable cost, a preference for purchasing them should be included in all solicitations relevant to construction, operation, maintenance of, or use in the building.

**C. Environmentally Preferable Products:** Use products, such as low-emitting materials or products containing non-toxic metals that have a lesser or reduced effect on human health and the environment when compared with competing products or services that serve the same purpose.

**D. Construction Waste and Materials Management:** During a project's planning stage, identify local recycling and salvage operations that could process site-related construction and demolition materials. Include in the design, the recycle or salvage of at least 50% of the non-hazardous construction, demolition, and land-clearing materials, excluding soil, where markets or on-site recycling opportunities exist. Provide salvage, reuse, and recycling services for waste generated from major renovations, where markets or on-site recycling opportunities exist.

**E. Ozone-Depleting Compounds:** Eliminate the use of ozone-depleting compounds during and after construction where alternative environmentally preferable products are available, consistent with the Montreal Protocol and Title VI of the Clean Air Act Amendments of 1990 or equivalent overall air quality benefits that take into account life cycle impacts.

# Section 1.9

## Accessibility

---

### Contents

1.9.0 Introduction

1.9.1 Guidance and Information



## 1.9.0 Introduction

Federal facilities must comply with standards issued under the Architectural Barriers Act Accessibility Standards (ABAAS). These standards apply to facilities designed, constructed, altered, or leased with Federal funds under the Architectural Barriers Act (ABA). The standards may be found online: <https://www.access-board.gov/>.

The Access Board maintains guidelines under the ABA, which serves as the basis for enforceable standards. It should be noted that the ADA and ABA have separate standards. NIH facilities shall abide by the ABA standards, which are enforceable by law. The ABA law was passed in Congress in 1968: as amended 42 U.S.C. §§ 4151 et seq.

---

## 1.9.1 Guidance and Information

HHS policy states, “The Architectural Barriers Act applies to any facility constructed, altered, leased, or financed with federal funds that is intended for use by the public or may result in employment of persons with disabilities.”

The NIH cannot grant waivers or variances for ABA compliance. All requests must be submitted to the U.S. Access Board and The Administrator of General Services. As per the ABA Standards Advisory F103 Modifications and Waivers: “The provisions for modifications and waivers differ from the requirement issued under the Americans with Disabilities Act in that ‘equivalent facilitation’ does not apply. There is a formal procedure for Federal agencies to request a waiver or modification of applicable standards under the Architectural Barriers Act.”

Please note the following critical requirements:

1. Accessibility requirements shall be included as part of the code analysis on the drawing submission(s).
2. Demolition and new design with accessible sinks, work surfaces, fixtures, and equipment shall be clearly noted and called out on drawings and included in all submissions.
3. Technical questions shall be directed to NIH’s DTR.

# Section 1.10

## Commissioning

---

### Contents

- 1.10.0 Introduction
- 1.10.1 NIH Cx Requirements
- 1.10.2 Cx Process During Different Project Phases
  - 1.10.2.1 Programming Phase
  - 1.10.2.2 Conceptual Design Phase
  - 1.10.2.3 Schematic Phase
  - 1.10.2.4 Construction Documents Phase
  - 1.10.2.5 Bidding Phase
  - 1.10.2.6 Construction Phase
  - 1.10.2.7 Acceptance Phase
  - 1.10.2.8 Endurance Test Phase
  - 1.10.2.9 Warranty Phase

## 1.10.0 Introduction

The NIH requires Commissioning (Cx) for all projects including new buildings, renovations, and expansions. The level or scope of Cx for any single project shall be determined by the complexity of the project. Complex laboratory and ARF facilities must have mechanical systems that provide correct control of environmental criteria such as air cleanliness, humidity, temperature, and pressurization. Depending on the scope and complexity of the project, commissioning may be required for the exterior envelope, interior finishes, and other components and systems which have an impact on the performance and function of the building. Commissioning serves to:

1. Reduce the number of deficiencies at completion.
2. Systems are efficient, cost-effective, and meet the user's operational needs.
3. Lower maintenance costs due to properly trained maintenance crew.
4. Increased productivity of the building occupants because of properly balanced ventilation system.
5. Design for maintainability.
6. Reduce outages and downtimes due to better diagnosis of failures.
7. Provides well documented and successful system tests.
8. Ensure all building systems perform in accordance with the design requirements.
9. Bridge the gap between design and functionality for HVAC and control design.
10. Bridge the gap between testing and balancing and BAS design and functionality.
11. Assist in achieving LEED or Green Globe certification.
12. Ensure the operators are adequately trained.

## 1.10.1 NIH Cx Requirements

**A. Requirements:** NIH Cx requirements shall occur parallel to established conventions ensuring design and construction quality. Commissioning shall provide monitoring and review of these conventional processes, and add supplemental processes for additional assurance of optimal performance. If the facility is a BSL-3 and/or ABSL-3, the facility shall be validated by DOHS. Commissioning of the laboratory systems will be observed by the DOHS/Safety Engineering Activity (SEA) group.

**B. Coordination:** Commissioning entails coordinating the efforts of the various parties involved in the design, construction, use, and operation of a facility to achieve an optimal facility. It is more comprehensive than conventional construction-phase quality-control activities such as construction observation, start up, testing, adjusting, and balancing.

**C. Dynamic vs. Static Systems:** NIH Cx focuses on the dynamic systems in the facility, such as the mechanical, electrical, plumbing, fire protection, and security systems. Although Cx is performed on some static systems, the need for Cx is more substantial on the dynamic systems. Other *DRM* requirements can often assure an adequate level of construction quality for the static elements.

**D. Planning/Schedule:** Planning and budgeting for Cx shall begin at the onset of a project. The Cx activities shall be included in the project schedule. Effective planning and a strong commitment to maintenance of a detailed, integrated project schedule will shorten the impact Cx has on the project duration.

**E. Cx Authority:** A Government-selected independent third-party commissioning authority (CA) is required and shall be funded by the project. The CA facilitates and assists other parties in the Cx process, but does not direct work or approve/accept materials, systems, or equipment. The CA makes recommendations to the appropriate party who directs work, approves or disapproves work, etc. The scope and budget of development managers (DMs), A/Es, construction managers, construction contractors, and all other entities involved with the project will be impacted by Cx.

**F. Personnel:** Maintenance, safety, and institute personnel, and others will also be involved in the Cx and will need to plan adequate resources from the beginning of the process. Roles and responsibilities are outlined below.

## 1.10.2 Cx Process During Different Project Phases

It is important for the A/E to be aware of the roles and responsibilities of different parties involved in the Cx process. In the following subsections, some of the critical roles and responsibilities of different parties involved in the Cx process during different project phases are defined. (This is not a comprehensive list; it is only meant to make parties conceptually aware.)

### 1.10.2.1 Programming Phase

During the programming phase, the project team, including facility users, outlines the functional requirements of the facility and documents the scope of Cx. The Cx sequence shall include:

- A. Cx requirements in all project related contracts
- B. Credentials related to Cx in selection criteria
- C. Cx in the project budget
- D. Documentation of the Owner's Project Requirements (OPR) in a format that is transferable to the Cx documentation
- E. Any additional, applicable regulatory requirements

### 1.10.2.2 Conceptual Design Phase

During the conceptual design phase, the project team, including facility users, forms the basis of design (BOD) and room data sheets. Cx sequence shall include:

- A. CA appointment and procurement
- B. CA development of the initial Cx plan
- C. CA review of the BOD and room data sheets
- D. CA to verify the Cx processes are identified in project scopes
- E. CA will build on A/E's BOD and room data sheets for the development of the Facility Guide and compare with OPR for inclusion of Owner's requirements.

### 1.10.2.3 Schematic Phase

During the schematic phase, the concepts of the project are developed to the point of schematic and single-line drawings. The Cx sequence shall include:

- A. Identification of the Cx team and onset of participation in the Cx process
- B. CA performance of the following:
  - 1. Conducts the Cx kick-off meeting
  - 2. Reviews schematic designs and design criteria
  - 3. Produces preliminary versions of Cx specification sections
- C. Naming conventions to be used on project equipment established and or directed by operators
- D. Update the Cx Plan

### 1.10.2.4 Construction Documents Phase

During the construction documents phase, a detailed design is completed and the contract documents are prepared for bidding. This phase may consist of multiple subphases. The Cx sequence shall include:

- A. A/E response to all schematic phase comments, development of a systems matrix in concert with developing the specification and submittal of draft specifications electronically
- B. Operators' review and comment on systems matrix and other documents
- C. CA development and completion of specifications on Cx requirements, completion of Cx plan and review of other construction-phase submittals, and development of a summary document that will track the Cx process
- D. CA development of Cx precedent diagrams to reflect Cx tasks and how to most effectively sequence systems turnover to minimize the Cx impact on the schedule
- E. A/E update of the BOD
- F. A/E response to all design review comments including Cx comments
- G. CA development of the design phase Cx plan

**1.10.2.5 Bidding Phase**

During the bidding phase, installation or construction is competitively bid and contractors/subcontractors are selected. The Cx sequence shall include technical support provided by the CA.

**1.10.2.6 Construction Phase**

During the construction phase of the project, the facility is built and the Cx sequence shall include:

- A. Designation of a Cx Coordinator (CxC) by all major subcontractors and operators to represent them in the Cx process
- B. Cx kick-off meeting conducted by the CA
- C. Incorporation of Cx tasks in detailed project schedule and presentation of an updated construction schedule at each Cx progress meeting
- D. CA review and comment on shop drawings and other submittals, inspections, and attendance of meetings, and production of detailed project-specific prefunctional and functional testing procedures
- E. Supplementation of the prefunctional procedures developed by the CA with contractor-provided submittals, and contractor-provided training plan for review by CA and operators
- F. CA and operators' review and approval of startup protocol
- G. Submittals of operations and maintenance (O&M) portions of the Facility Guide and a Temporary Conditioning Plan by the contractor for review by A/E, CA, and operators
- H. Witnessing of close inspections by operators, CA, and PO
- I. Recording of all nameplate data by the contractor
- J. Training provided by the contractor
- K. Design intent and systems overview training by the A/E with assistance from the CA

**1.10.2.7 Acceptance Phase**

During the acceptance phase, the facility and its systems and equipment are inspected and tested. Most of the formal training occurs during this phase, generally occurring after the construction phase is complete. The A/E and contractor finalize "as-built" record documentation. Approved functional completion marks the end of this phase. If the facility is a BSL-3 and/or ABSL-3, the facility shall be validated by DOHS. Commissioning of the laboratory systems will be observed by DOHS. DOHS or a DOHS designated consultant will provide a test script for the failure scenario testing to the CA for validation of the laboratory. The CA personnel will support DOHS validation of the laboratory. The contractor will be responsible for any deficiencies identified during the DOHS validation if they were part of the contractor's scope of work.

DOHS or a DOHS designated consultant and specialized contractor provides oversight of BSL-3 and ABSL-3 safety programs in biomedical laboratories and ARFs, with involvement during the planning, design and construction phases of new and alteration projects. The PO and design team shall involve DOHS/SEA early during the planning and design process for any project to obtain input on proposed designs from a safety-management perspective.

The Cx sequence shall include:

- A. Establishment of systems' trending and monitoring by the contractors
- B. Spot check startups and balancing by the CA and the operators
- C. Functional Operational Systems Test (FOST) directed/conducted by the CA, in which most parties also participate to some degree. The CA and operators continue FOSTs, performing repetitive sampling.
- D. FOST documentation by the CA, recommendations of acceptance as applicable, and update of FOST.
- E. Development and performance of commissioned systems training by the CA
- F. Completion of record documentation and submittal for approval by the contractor and A/E
- G. Remedies by the contractor to issues that caused failure of FOSTs and CA retests

### 1.10.2.8 **Endurance Test Phase**

During the endurance test phase, equipment is run continuously, monitored, and trended. This phase is applicable to critical occupancies such as BSL-3, ARF, data-centers, and other areas as directed by the PO. The Cx sequence shall include:

- A. CA ensures monitoring is in place and functional throughout this period
- B. Use of the space by occupants to confirm functionality
- C. Proper operation of the facility throughout this period

### 1.10.2.9 **Warranty Phase**

The warranty phase includes the early occupancy of the building through the end of the warranty period, and at

least into the opposite season from when it was initially tested. The contractor performs warranty service and all manufacturer required maintenance, corrects deficiencies, and finalizes record documentation to reflect actual conditions at the end of the warranty period. The operators work with the CA and the A/E to fine tune the facility to meet actual occupancy. The Cx sequence shall include:

- A. Onset of warranty upon completion of the acceptance phase
- B. Submittal of final Cx report by the CA and important lessons learned, changes made, etc.
- C. Maintenance of a log of warranty calls that tracks diagnosis and resolution by the contractor
- D. Operator-initiated warranty calls, as necessary
- E. Record documentation is updated as necessary
- F. Performance of opposite-season testing by the CA
- G. Documentation of issues and problems with the facility by the operators
- H. Occupants' use of the facility
- I. Renovations or modifications to the facility, if done, in conformance to the limitations dictated in the Facility Guide.



# Section 1.11

## Environmental Management and Radiation Safety

---

### Contents

#### 1.11.0 Introduction

#### 1.11.1 Common Safety Issues

#### 1.11.2 Safety Guidelines and References

#### 1.11.3 General Hazardous Substances Receiving, Storage, Staging, and Handling Criteria

##### 1.11.3.1 General Waste Management

##### 1.11.3.2 Recycling

##### 1.11.3.3 Waste Water Discharge, Sampling & Treatment

##### 1.11.3.4 Hazardous Waste Storage and Handling at On-Campus Facilities

##### 1.11.3.5 Hazardous Waste Storage and Handling at Off-Campus Facilities

#### 1.11.4 Bulk Storage Facilities/Above-Ground Storage Tanks

#### 1.11.5 Decommissioning

##### 1.11.5.1 Condition Assessments

##### 1.11.5.2 Recycling Demolition Debris

#### 1.11.6 Radiation Safety

##### 1.11.6.1 Radioactive Waste Storage

##### 1.11.6.2 Radioactive Waste Storage and Handling at On-Campus Facilities

##### 1.11.6.3 Radioactive Waste Storage and Handling at Off-Campus Facilities

##### 1.11.6.4 Radioactive Waste Storage and Handling in Laboratory Modules

## 1.11.0 Introduction

**A. General:** This section describes the general requirements and specific goals for managing environmental issues on NIH campuses, including:

1. Bulk storage facilities
2. Hazardous materials storage and handling
3. Hazardous waste storage and handling
4. Radiation safety
5. Solid waste management and recycling
6. Waste water discharges

Attention to environmental management issues and proper waste handling is a key element of the NIH overall goals of ensuring the health and well-being of NIH employees, visitors, and neighbors, and maintaining the NIH campus atmosphere. In this subsection, “on-campus” refers to the NIH Bethesda, Maryland facility; “off-campus” refers to all other NIH facilities.

**B. Laws:** The *DRM* requirements for environmental management on the NIH campus encompass the current Federal and State of Maryland regulations regarding environmental management issues. They also include the requirements of local governments and agencies such as the Washington Suburban Sanitary Commission (WSSC) and Montgomery County, Maryland. Federal laws applicable to environmental management on an NIH campus include:

1. Clean Air Act
2. Clean Water Act
3. Hazardous Materials Transportation Act
4. National Environmental Policy Act
5. Resource Conservation and Recovery Act
6. Safe Drinking Water Act
7. Toxic Substances Control Act
8. Worker Safety Requirements

The National Environmental Policy Act (NEPA) applies to all projects regardless of size. This is a joint process between the PO, Division of Environmental Protection

(DEP), and Division of Facilities Planning (DFP) to determine the appropriate action. Based on a preliminary project description (scope), it may be possible to determine that no further action is necessary. Possible further actions include categorical exclusion, development of an Environmental Assessment (EA), or an Environmental Impact Statement (EIS). A flowchart of the NEPA process is maintained by the DEP.

**C. Exclusions:** Certain environmental issues have been excluded from this section of the *DRM* and addressed elsewhere. See [Chapter 3: Civil Engineering & Site Development](#) and [Chapter 8: Plumbing Design](#) for storm water management, sediment control, erosion control, wetlands, and use of fertilizers in landscaping. Refer to [Section 1.12 Integrated Pest Management](#) for use of pesticides. It is the goal of NIH to fully comply with all Federal and state requirements in these areas.

**D. Sediment and Erosion Control (SEC) Drawings:** Sediment and erosion control (SEC) drawings shall be prepared for all projects that result in ground disturbance. See [Chapter 3](#) for Sediment and Erosion Control.

---

### 1.11.1 Common Safety Issues

**A. Hazardous Substances:** All NIH facilities shall be designed to minimize the use of hazardous substances. The use of alternative non-hazardous or non-toxic materials is preferred in all new construction and renovations. The A/E shall develop a plan for eliminating the use of hazardous substances. Where hazardous substance use is unavoidable, the A/E shall demonstrate that alternate non-hazardous substances are either not available, inferior to the hazardous substance, or cost prohibitive. Examples of hazardous substances that shall be avoided include, but are not limited to oil-based paints and caulks; hazardous cleaning, surface preparation, and paint-stripping solvents; and petroleum-based contact adhesives.

**B. Air Quality:** In general, most new construction will result in the release (off-gassing) of odors that can affect occupant comfort. If hazardous substances are avoided in construction, these odors will generally be non-hazardous; however, they can still have a detrimental effect on indoor air quality. Examples of non-hazardous substances that can affect indoor air quality include systems furniture, carpets, and latex paints.

**C. Off-Gassing:** New facilities shall be allowed to off-gas prior to occupancy. Ventilation systems of new construction shall be operated for a minimum of one month before the building is occupied. For renovations, where it is not feasible to isolate NIH employees from the off-gassing, materials that will off-gas and affect indoor air quality shall be allowed to air out and off-gas in a warehouse or in a well ventilated, unoccupied area before they are installed. There are many materials of concern such as carpet, sheet vinyl, laminates, among others; a minimum of two weeks, or as required by green building/sustainability certification, should be allowed for off-gassing before installation. Requirements may vary based on PO's discretion.

**D. Insecticidal Dusts:** Insecticidal dusts, such as boric acid, shall not be applied in wall cavities, voids, and/or chase areas as part of the facility construction or renovation.

*Rationale: Insecticidal dusts pose a health risk during application and have the potential to expose workers to pesticide. Future demolition and/or renovation of spaces that have been pretreated can expose workers to health risks. Dusts, such as boric acid, once applied are very difficult to remove fully and can be carried significant distances by air currents.*

## 1.11.2 Safety Guidelines and References

The A/E shall use and comply with the design and safety guidelines, and references listed in [Section 1.2 Referenced Codes, Standards, and Organizations](#) and cited throughout this section, as well as other safety guidelines received from the PO or as required by the program. The A/E shall utilize the latest editions of design and safety guidelines available at the time of the design contract award.

## 1.11.3 General Hazardous Substances Receiving, Storage, Staging, and Handling Criteria

**A. Receiving Areas:** Hazardous substances used at the NIH facilities fall into two categories. They are (1) substances used in the facility directly for research activity such as laboratory chemicals used to perform analyses, or (2) substances used in support of the facility such as chemicals used for washing glassware, cage washing, or neutralizing waste water discharges.

**B. Hazardous Substances:** Hazardous substances used in a laboratory are delivered directly to the end-user laboratory from the loading dock. Staging and temporary storage areas shall not be required in the receiving area for these materials.

**C. Support Materials:** Materials used in support of a facility must be placed in a hazardous-substance storage area. In general, these materials are received in 220 L (58 gal) drums or larger. Some neutralization chemicals may be stored in bulk containers up to 1,600 L (423 gal). Storage capability shall be provided for up to ten drums. Buildings utilizing these hazardous substances shall be designed with a receiving and storage area located at or near the point of use of the materials and shall be used for long term storage of hazardous materials.

**D. Storage and Staging Areas:** Hazardous-substance storage areas shall be out of the normal flow of personnel traffic and shall be located near the loading dock for easy access to the trucks used to transport the waste for processing. See [Section 4.8 Loading Docks](#). Convenient access from the storage room to the freight elevator shall be provided without having to traverse heavily used corridors so as to minimize the risks to the building occupants during transport of the waste.

**E. Size of Storage/Staging Area:** The storage and staging area shall be large enough to store the hazardous substance containers and provide room for loading and unloading the drums or containers. If multiple substances are stored, the design shall allow incompatible materials to remain segregated while in storage.

**F. Spill Containment:** Spill containment in each section of the storage room shall be designed to contain any

spills of hazardous waste resulting from mishandling the waste materials. The A/E shall propose alternative means for spill containment within the storage room. Options include a spill-containment curb around the room, secondary containment bins, shelving designed to contain spills, or a combination thereof. Any curb used for containment spills shall be designed to allow convenient ingress/egress using a drum trolley. Each section of the storage area shall be designed to contain a spill at a minimum equal to the volume of the largest container. The configuration of the storage area shall be designed to facilitate spill cleanup. Interior surfaces of the storage area shall be cleanable, corrosion resistant, and non-reactive.

**G. Walls and Floor:** A chemical-resistant coating shall be applied to the walls and floor in this area to facilitate the cleanup of spills. These areas shall be thoroughly caulked and sealed to exclude pests and minimize pest harborage.

**H. Safety Equipment:** Safety equipment including emergency eyewash, emergency shower, and a telephone shall be provided for each storage room and staging area. The telephone to contact emergency response personnel shall be located either in the room or within 10 m (33 ft.) of the room.

### 1.11.3.1 General Waste Management

**A. General:** This section is applicable to the NIH Bethesda campus. Other NIH campuses and sites may vary with their waste protocols and their Authority Having Jurisdiction's (AHJ) requirements. In general, there are five types of waste to consider: medical pathological waste (MPW), chemical waste, multihazardous waste, radioactive waste, trash, and recycling. See the DEP's Waste Management Services website for additional waste requirements (<http://orf.od.nih.gov/EnvironmentalProtection/WasteDisposal/Pages/default.aspx>).

**B. Waste Minimization:** All biomedical laboratories and ARFs at the NIH shall adhere to the Environmental Protection Agency's (EPA's) solid waste management hierarchy, encouraging reduction of waste at the source. This hierarchy emphasizes waste minimization as the first step in sound solid waste management.

**C. Ease and Convenience:** The requirements for environmentally friendly solid waste management shall be

included in the design of new construction for the solid waste management system to be efficient and convenient to use. Ease and convenience are keys to implementation of a successful solid waste management program.

**D. Reusable Products:** The utilization of reusable products, reducing the overall solid waste stream is encouraged.

**E. Recycling:** Waste products that cannot be reused shall be investigated for possible recycling. Only those products that cannot be reused or recycled shall enter the waste stream for energy recovery or land fill.

**F. Waste Compaction:** All facilities shall be designed with modern and sanitary waste compaction equipment. This equipment shall minimize spillage of wastes and debris, and the attraction of pests.

**G. Hazardous Waste Generation:** Hazardous substance storage capacity can assist in laboratory waste minimization. The A/E shall closely examine the anticipated use of the laboratory to determine a reasonable volume of hazardous substances stored in the laboratory to allow efficient laboratory operations. Excessive storage space in a laboratory can result in over-purchasing, hoarding of hazardous substances, and possible storage beyond useful shelf life, resulting in excessive hazardous waste generation.

### 1.11.3.2 Recycling

**A. Recycling Materials:** The NIH campus has an active solid waste recycling program. The program is administered by the DEP. This program establishes white office paper, baled corrugated cartons, aluminum cans, and polypropylene as primary recycling materials. Mixed paper, wood pallets, scrap metal, polystyrene, food and beverage containers, and yard waste are designated as secondary recyclable materials.

**B. Recycling Friendly:** All new construction on the NIH campus shall be designed to be recycling friendly. Collection containers placed at convenient locations throughout the building enable NIH employees to accumulate recyclable materials. The selection of recyclables to be collected; the type, size, and number of collection containers; and the locations for the collection containers shall be determined by the A/E on the basis of the planned use of the new facility. The A/E shall coordinate this selection with the DEP.

**C. Support Facilities:** Support facilities for recycling shall be included in all new construction. These support facilities include space in the loading dock area for storing recyclable materials. Paper products, particularly white paper, must be kept clean and dry to maintain market value and be stored in a way so as not to attract pests or offer them harborage, requiring either a room for storage or an enclosed container. Other recyclable materials also require sufficient container space. Multicompartment recycling roll-off containers are commercially available and may be used for recyclable storage and transportation. The potential for attraction of pests to these containers shall be considered when designing a placement site. The placement of these containers shall not affect personnel using the loading dock.

**D. Aluminum Cans:** A can-flattener shall be considered for any facility expected to generate sufficient aluminum cans. The selection of the recycling support facilities and equipment required for all new construction shall be made by the A/E in coordination with DEP. Potential options for the loading dock design have been developed by the ORF and can be used per program requirements by the A/E.

**E. Space Allocation:** Recycling space should be provided on each floor or within each tenant space as well as at the loading dock, and must be sized to contain at least three days of recycled materials. Recycling containers are to be located outside of the loading dock.

**F. Sorting Space:** At recycling and trash rooms, space must be allowed for sorting and recycling of paper, bottles and cans, metals, and other materials.

### 1.11.3.3 Waste Water Discharge, Sampling & Treatment

See *DRM Chapter 8: Plumbing Design* for additional drainage and waste water requirements.

All waste waters generated on the NIH campus shall be discharged to the sanitary sewer. Waste waters generated on the NIH campus include domestic sewage from the lavatory facilities, non-hazardous waste discharged from laboratory or research area sinks, water used for cage washing and animal care, and water from all floor drains.

**A. Permits:** The NIH is permitted to discharge waste water to the Washington Suburban Sanitary Commission

WSSC system through a Discharge Authorization Permit. Under the terms of this permit, the NIH must sample its waste water four times every six months and submit an Industrial User Effluent Compliance Permit report to WSSC twice per year. The waste water sampling is conducted at two locations where NIH sewers connect to the WSSC system.

**B. New Construction:** For new biomedical laboratory and ARF construction, the sanitary system shall be designed to allow for sampling at the discharge point from the individual building.

**C. Sampling Point:** The sampling point shall be designed to allow for installation of a continuous pH monitor, installation of a programmable sampler, and personnel access for grab sampling. Cage washing facilities and laboratory facilities shall be provided with a continuous pH monitor and recorder. The pH monitor shall provide an alert to the building automation system.

**D. Treatment:** Because the NIH utilizes the WSSC system, it is normally not necessary to perform waste water treatment on campus. However, it may be necessary to provide neutralization and equalization of waste water streams from some biomedical laboratory and ARFs to comply with discharge requirements and to minimize the risk of damage to NIH campus piping infrastructure.

**E. Silver Recovery:** Any facility designed with dark-rooms or photo-processing facilities shall have a processing facility for recovering silver from the waste water stream from the photo-processing rooms.

### 1.11.3.4 Hazardous Waste Storage and Handling at On-Campus Facilities

**A. General:** Laboratory and ARF buildings on the NIH campus shall be designed with a room for temporary storage of hazardous waste and radioactive wastes. Mixed waste (hazardous waste that is also radioactive) shall be treated as radioactive waste in this temporary storage area. Hazardous waste is generally stored in this room for several hours or overnight. Refer to [1.11.6.1 Radioactive Waste Storage](#).

**B. Layout and Size:** Two individual storage sites shall be designed—one for hazardous waste and one for radioactive waste. The storage room shall be large enough to provide for temporary storage of the hazardous waste



and radioactive waste, and for storage of specialized carts to transport the hazardous waste from the laboratories. The hazardous waste storage section shall be 2,500 mm x 3,500 mm (8 ft. 2 in. x 11 ft. 6 in.) minimum. The radioactive waste storage section shall be 750 mm x 1,500 mm (2 ft. 6 in. x 4 ft. 11 in.) minimum.

**C. Storage Cabinets:** A minimum of three, 2 m (6 ft. 7 in.) high storage cabinets shall be provided in each room to provide segregated storage of incompatible materials. Open floor space in the storage room shall accommodate one, 1 m (3 ft. 3 in.) long waste cart and allow access to the storage cabinets and shelving.

All wet laboratories shall contain an approved ventilated acid (corrosive) cabinet and an approved flammable materials storage cabinet. The sizes of these cabinets shall be based on the volume of corrosive and flammable materials used in the laboratory.

**D. Spill Containment:** Waste materials are normally transported using specialized carts that provide spill containment. Spill containment shall be designed per [Section 1.11.3 Storage and Staging Areas](#).

**E. Floors and Walls:** Floor and walls shall be designed per [Section 1.11.3 Storage and Staging Areas](#).

**F. Ventilation System:** A separate ventilation system shall be installed for the storage room. Exhaust shall be directed away from the building and surrounding buildings' air intake. This ventilation system shall be connected to the building's emergency power system.

**G. Lighting:** Standard illumination levels apply to this room. Lighting fixtures shall be lensed, sealed, and gasketed.

**H. Safety Equipment:** Safety equipment shall be designed per [Section 1.11.3 Storage and Staging Areas](#).

**I. Design Review and Approval:** The Division of Radiation Safety (DRS), the Division of Environmental Protection (DEP), the Division of Occupational Health and Safety (DOHS), and the Division of the Fire Marshal (DFM) shall review all designs for hazardous waste storage rooms and shall provide the final approval of the design. The PO shall coordinate this review and approval.

**J. Laboratory Modules Waste Storage:** All laboratory modules shall be designed for the safe storage of

hazardous substances while discouraging the storage of excessive amounts of hazardous substances.

**K. Hazardous & Radioactive Storage:** The location of radioactive storage cabinets shall be standardized in the laboratories to assist emergency-response personnel and optimally located near the laboratory door for convenient access by the technician collecting the hazardous waste. For laboratory modules with a service corridor, the storage area shall be located near the service entrance rather than the hall entrance, avoiding the transport of hazardous waste through the main corridors of the laboratory building. There shall be no flammable storage cabinets located under fume hoods. Acid storage cabinets shall be ventilated and are typically located beneath fume hoods. If no fume hood is present, exhaust ventilation must be provided to these cabinets. Acid cabinets and flammable material storage cabinets shall be located diametrically opposed from each other and towards the back of the laboratory away from the laboratory entrance.

### 1.11.3.5 Hazardous Waste Storage and Handling at Off-Campus Facilities

Laboratory buildings located in Montgomery County, Maryland, but not located on the NIH Bethesda campus shall be designed per this section. Hazardous waste may be stored in these rooms from sixty to ninety days.

**A. Location:** The storage room shall be located near the loading dock for easy access to the trucks that will be used to transport the waste to the NIH campus for additional processing. Because this waste will be transported over public roads, the room shall also be used to prepare the hazardous waste for shipment. Processing conducted in this room includes bulking waste into larger containers, laboratory packing individual waste containers, and labeling and manifesting the containers for shipment.

Convenient access shall be provided from the storage room to the freight elevator without having to traverse heavily used corridors. Because these laboratories are typically leased space, it may be difficult to meet these criteria. In this case, consideration shall be given to alternate uses of this leased space that will not generate hazardous waste.

**B. Layout and Size:** The storage room shall be divided into two sections. The first section shall be large enough

to provide for temporary storage of the hazardous waste as it is received from the laboratories and after it has been packed for shipment. The second section shall be used for bulking and packaging the waste. Space for preparing manifests and other documentation shall be provided, either in the storage area or in an additional space outside the room. Space for storing specialized carts used to transport the hazardous waste from laboratories shall also be provided.

**C. Spill Containment:** Spill containment shall be designed per [Section 1.11.3 Storage and Staging Areas](#).

**D. Floors and Walls:** Floor and walls shall be designed per [Section 1.11.3 Storage and Staging Areas](#).

**E. Ventilation System:** The ventilation system shall be designed per [1.11.3.4 Hazardous Waste Storage and Handling at On-Campus Facilities](#) with the following additional requirements:

1. The ventilation system shall be spark proof.
2. The ventilation system shall be designed to allow easy access for routine or emergency maintenance from outside the containment area.
3. The ventilation system shall be connected to the emergency power system, if available.

**F. Safety Equipment:** Safety equipment shall be designed per [Section 1.11.3 Storage and Staging Areas](#).

**G. Fume Hood:** A walk-in fume hood shall be provided in the bulking and packaging area, where exposure to harmful fumes is possible.

**H. Explosion-Proof Design:** An explosion panel designed to dissipate the impact of an explosion shall be provided in the storage room.

**I. Lighting & Electrical Requirements:** Lighting and other electrical devices shall be explosion-proof. Consideration should be taken to limit quantity of devices placed within these areas.

**J. Design Review and Approval:** DEP, DRS, and DOHS shall review all designs for hazardous waste storage rooms and shall provide final approval of the design. The PO shall coordinate this review and approval.

**K. Laboratory Module Waste Storage:** All laboratory modules shall be designed for the safe storage of

hazardous waste generated by laboratory activities. The volume of hazardous waste generated by a laboratory is a function of the type of work being performed in the laboratory. The A/E shall consider the function of the laboratory to determine the space necessary for hazardous waste storage. At a minimum, a 750 mm x 750 mm (2 ft. 6 in. x 2 ft. 6 in.) area shall be required.

The A/E must also recognize that some types of hazardous waste may be incompatible and shall design the hazardous waste storage area to accommodate multiple containers. The A/E shall investigate the possibility of stacked containers that will provide sufficient storage space while minimizing the footprint in the laboratory. Each storage container shall be designed to provide secondary containment of hazardous wastes. This storage area shall have a minimum of two physically separated sections to allow segregation of incompatible materials. Some laboratories may require three segments depending on the types of hazardous waste that will be generated. Storage areas shall be designed per [1.11.3.4 Hazardous Waste Storage and Handling at On-Campus Facilities](#).

**L. Lab Module Storage Location:** The location of the hazardous waste storage area in laboratories shall be standardized to assist emergency response personnel and shall be designed per [1.11.3.4 Hazardous Waste Storage and Handling at On-Campus Facilities](#).

**M. Select Agent Waste:** Laboratory waste storage containing select agents must meet the requirements of the Federal Select Agent Program for secure storage. Select agent waste must remain secured until sterilization has been confirmed.

---

## 1.11.4 Bulk Storage Facilities/ Above-Ground Storage Tanks

**A. Fuels:** The A/E shall consider the use of clean-burning fuels such as natural gas or liquid propane. Above-ground storage tanks shall be provided in accordance with state of Maryland and Montgomery County, Maryland, requirements if fuel storage is required (i.e., a day tank ensuring uninterrupted availability of fuel).

**B. Tank Construction:** All above-ground storage tanks shall be double-walled, provided with secondary



spill containment, and meet the requirements of the American Petroleum Institute and the NFPA. The tanks shall also be consistent with the NIH Spill Prevention, Control, and Countermeasures Plan.

**C. Location:** Above-ground storage tanks shall be located to provide access for delivery trucks. Concurrently, the tanks shall be sufficiently isolated and protected from traffic flow to minimize accident risks. The tanks shall be placed in a location to minimize the aesthetic impact of the tank on the surroundings, including the use of beams and landscaping to block the view of the tanks. The use of bollards should be considered for physical protection from vehicular traffic.

**D. Spill Control:** All bulk storage facilities and above-ground storage tanks shall be equipped with secondary containment to prevent discharge of the material in the event of a spill or a leak. For single storage tanks, the secondary containment shall be large enough to contain the volume of the tank and rainfall from a ten year, twenty-four hour storm. For multiple storage tanks, the secondary containment shall be large enough to contain the volume of the largest tank and rainfall from a ten year, twenty-four hour storm.

**E. Tank Construction:** Materials used to provide the secondary containment shall be impervious to the substance contained in the storage tank. The containment shall be equipped with a normally closed valve to prevent accidental discharge of the substance from the containment. This valve can be manually opened to discharge accumulated rainwater after it has been determined that the water is not contaminated.

**F. Loading Docks:** Other potential spill areas for hazardous substances on the campus are loading docks where spills can occur during the loading and unloading of hazardous substances or hazardous wastes. Loading docks shall be designed to contain spills of hazardous substances and minimize the contamination of storm water runoff. The loading dock shall be provided with grate drains equipped with a normally closed valve to prevent accidental discharge of spilled substances, and to accumulate any spilled substances at the base. Uncontaminated runoff should be diverted from this drain by a second grate drain and a small berm. An overhang should divert direct rainfall from the base of the loading dock to the uncontaminated runoff drain. The A/E may propose alternative designs that meet this objective. For control of storm water runoff and

water quality, see [Chapter 3: Civil Engineering & Site Development](#) and [Chapter 8: Plumbing Design](#).

---

## 1.11.5 Decommissioning

**A. General:** NIH campus facilities shall be decommissioned prior to renovation. Decommissioning shall include an in-depth facility assessment by a qualified environmental engineer approved by the DOHS, DEP, and DRS. The site or facility assessment is required prior to demolition.

**B. Assessment:** The facility assessment shall identify any environmental or other site hazards that could result in the release of hazardous substances during demolition or could pose a hazard to workers. Contact DEP for review and approval of decommissioning plans. Follow ANSI Z9.11 for decommissioning guidance. Radiological decommissioning is governed by the Multi-Agency Radiation Survey and Site Investigation Manual (MARSSIM).

**C. Potential Hazards:** Potential hazards addressed during the facility assessment include, but are not limited to, asbestos-containing building materials, polychlorinated biphenyls, lead and lead paint, mercury, underground storage tanks, hazardous substance storage areas, radioactive materials and storage, and spills of hazardous materials. The DRS evaluates whether there is potential for residual contamination from long-lived nuclides and to what degree a space needs to be surveyed. Potential hazards are outlined in the Checklist for Hazardous Substances available from the DEP. Because new and changed regulations have an impact on the decommissioning process, POs and A/Es must obtain the latest edition of this document from the DEP for each project.

### 1.11.5.1 Condition Assessments

Condition assessments are required for every NIH renovation project, regardless of facility type. The condition assessment shall include the following quantitative data to substantiate the qualitative assessment:

**A. Review of records** regarding the design, construction, and use of the building to be demolished and the site

**B.** Review of records and documents regarding the use of radioactive materials in the facility and potential for long-lived radionuclide contamination

**C.** Review of records regarding responses to hazardous substances spill incidents or other emergencies

**D.** Visual inspection of the building and site

**E.** Sampling and analysis of subject materials

The end result of the condition assessment shall be a decommissioning plan for the facility, which shall include all recommended procedures for decontamination.

### 1.11.5.2 Recycling Demolition Debris

Prior to mobilization on the site, the demolition contractor shall be required to submit a waste disposal and recycling plan for the demolition activity to the DEP. This plan shall identify each type of waste material generated by the demolition. The wastes shall be classified as hazardous waste, general waste, or recyclable waste. The alternatives for disposing or recycling of each type of waste material shall be discussed in the plan, with the objective of recycling the maximum amount of demolition materials. For any material not recycled, the contractor shall be required to document in the plan, to the satisfaction of the DEP, why recycling is not feasible.

## 1.11.6 Radiation Safety

**A. Exposure:** The intent of this section is to provide the A/E with a working knowledge of the facility design parameters required for the control and containment of radiation hazards. Work performed at NIH laboratories involves the potential for occupational exposure to radioactive materials and other sources of ionizing and non-ionizing radiation. Although laboratory procedures identify good radiation safety practices and techniques essential to minimize potential exposure to radiation, the security, containment, and shielding of this material and equipment through the use of good facility design is important.

**B. Radiation Sources:** Not all sources of ionizing radiation are covered by Nuclear Regulatory Commission (NRC) licensing. The non-licensed sources are, however,

controlled by DRS policies approved by the Radiation Safety Officer or the NIH Radiation Safety Committee. Non-licensed sources include X-ray machines, high-voltage medical accelerators, electron microscopes, and radioactive materials from sources other than reactor byproducts or particle accelerators. In addition to the protection of occupationally exposed workers, the DRS must ensure that the general public, surrounding environs, and maintenance staff are also provided with an adequate and similar degree of protection.

**C. Background:** The DRS provides guidance and technical information concerning the use of radioactive materials as well as policies and procedures for radiation producing machines and areas. Radiation safety control, containment, and shielding design and laboratory practices minimize the potential for radiation exposure to workers and radiation release to the environment.

**D. Specific Areas of Concern:** The following are key radiation safety issues of particular concern:

1. Laboratories using radionuclides
2. Radioactive airborne and liquid effluent sampling
3. Devices used in medical research, such as X-ray machines, accelerators, and irradiators
4. Non-ionizing radiation (under DOHS purview)
5. Radioactive materials security requirements

**E. Security:** All radioactive materials stored at any NIH facility shall be secured. Unattended laboratories in which radionuclides are in use or stored shall be locked, or radioactive materials shall be locked in containers, refrigerators, or freezers. For other security options such as physical access control contact PO to coordinate with the Division of Physical Security Management (DPSM); see [Section 1.13 Security Requirements and Procedures](#).

### 1.11.6.1 Radioactive Waste Storage

**A. General:** All new biomedical laboratory and ARF buildings on campus and off campus shall be provided with a minimum of one radioactive waste storage room located inside and directly adjacent to the loading dock. The room shall provide a minimum of 14 m<sup>2</sup> (151 ft<sup>2</sup>) of floor space. Only card-key access shall be provided

to the room.

**B. Materials:** Adjustable height bi-level metal shelving with lipped edges and corrosion resistant coating for spill containment to provide segregated storage of wastes of various compatibility classes shall be provided.

**C. Layout and Size:** A 100 mm (4 in.) high containment floor berm shall be provided at the entrance to the room for specified containment and be sloped to allow carts and dollies to easily pass. Two alternates are also acceptable:

1. Room flooring designed 100 mm (4 in.) lower than corridor flooring with smooth transition ramp leading into room
2. Room flooring designed to gradually slope away from the entrance to provide the same containment capacity

No floor drains shall be located in this room. Flooring shall be of impervious material, highly resistant to organic solvents, non-slip, and with no cracks, joints, or drains. Floor and wall junctures shall be coved and of the same material as the floor.

**D. Electrical Specifications:** One duplex electrical outlet on each wall of the room shall be provided. Lighting fixtures shall be lensed, sealed, and gasketed.

**E. Medical Waste Cold Box:** Medical waste cold boxes used to store medical pathologic waste (MPW) shall be used to store animal carcasses, tissues, and bedding contaminated with radioactive materials. The medical waste cold box storage room shall be located inside and directly adjacent to the loading dock. Contact the DEP for medical waste cold box specifications.

**F. Coolers and Walk-ins:** Coolers and/or walk-in freezers shall be located in each building with laboratories conducting biomedical research with radioactive materials.

### 1.11.6.2 Radioactive Waste Storage and Handling at On-Campus Facilities

Laboratory buildings shall be designed with a separate area for the temporary staging of hazardous and radioactive waste. Mixed waste (hazardous waste that is also radioactive) shall be treated as radioactive waste in this temporary staging area described in previous

subsections. Only specific issues that are directly related to radioactive waste are discussed here. Information on the carts and equipment for the transfer of radioactive waste currently in use can be obtained from the DRS. The staging area shall be sized to provide for temporary storage of the radioactive waste and the specialized carts used to transport the radioactive waste from the laboratories. The staging area shall be designed to contain any spills of radioactive waste that may occur during handling of the waste materials. This can be accomplished using specialized carts; however, the A/E may propose alternate means for spill containment. Special consideration shall be given to this area in the fire protection design per NRC RIS 2008-12, specifying the fire protection and suppression systems to minimize the likelihood and extent of fire.

### 1.11.6.3 Radioactive Waste Storage and Handling at Off-Campus Facilities

Specific issues directly related to radioactive waste are discussed in this section. Laboratory facilities not located on the NIH campus shall be designed with a room for use in processing and staging hazardous and radioactive waste. Mixed waste shall be treated as radioactive waste in this room. The waste shall be transported to the NIH campus for additional processing and shipping to the long term radioactive waste storage facility. Because the waste is transported over public roads, this room shall be used to prepare the radioactive waste for shipment. Processing conducted in this room shall include bulking of waste into large containers, laboratory packing of individual waste containers, and labeling and manifesting the containers for shipment. A bulking hood to perform these activities shall be provided. A service elevator on the premises shall be available to transport the radioactive waste to the appropriate marshalling area in the building. If a service elevator is not available, the use of a passenger elevator may be appropriate; however, dedicated times shall be required to transport the radioactive waste.

The staging room shall be divided into two separate sections. The first section shall be large enough to provide for temporary storage of the radioactive waste as it is received from the laboratories and after it is packed for shipment. The second section shall be used for bulking and packaging the waste. Sufficient space shall be provided for storing the specialized carts used to transport the radioactive waste from the laboratory. The staging

room shall be designed to contain any spills of radioactive waste that may occur during handling of the waste materials. Spill containment in the bulking and packaging area may be accomplished with a curb around the area, secondary containment bins, or a combination thereof. These areas shall be thoroughly caulked and sealed to minimize pest harborage and exclude pests. It is important to note that prior to contracting for leased space that will require remodeling, renovation, or other extensive architectural or engineering work, DRS shall be informed and provide the necessary technical assistance.

#### 1.11.6.4 Radioactive Waste Storage and Handling in Laboratory Modules

**A. General:** All laboratory modules shall be designed for the safe storage of radioactive waste. The volume of radioactive waste generated by a laboratory is a function of the type of work being performed. The A/E shall consider the function of the laboratory to determine the space necessary for radioactive waste storage, recognize that some types of radioactive waste require segregation from other types, and design the radioactive waste-storage area to accommodate multiple containers. All laboratories shall be designed to fit the appropriate low-level radioactive waste (LLRW) storage receptacles and/or containers. Contact the DRS for specifications on these containers. Five LLRW streams have been identified from the NIH Waste Disposal Calendar, current edition:

1. Liquids aqueous waste and/or solvents/other hazardous chemical constituents (mixed waste)
2. Dry or solid waste (dry active waste) – disposable lab ware and/or sharps (can also be categorized as MPW)
3. Liquid scintillation vials and/or bulk liquid scintillation media
4. Animal carcasses and/or tissues
5. Animal bedding and/or solid excreta

**B. Containers:** The size of the space dedicated to each of the containers shall be based on the volume of radioactive materials generated and/or research activities performed in the laboratory. Standard-sized containers are available from the radioactive waste contractor.

Container placement locations shall be considered in the design for ease of access and pick-up.

**C. Location:** A standard location of the radioactive waste storage in laboratories shall be established to assist emergency response personnel. For laboratory modules with a service corridor, this storage shall be located near the service entrance rather than the hall entrance, eliminating the need for moving radioactive waste through the main corridors of the laboratory building. The configuration of the radioactive waste storage area in the laboratory shall be designed to facilitate radioactive material spill cleanup and decontamination. Interior surfaces of the storage area shall be readily cleanable for ease in decontamination. Corridors and public space shall not be designated and used for storage, and equipment such as refrigerators and freezers shall not be designated to store this material in these areas. The A/E shall include the following in the design:

1. Physical security measures and systems to protect against unauthorized access in all laboratories. For specific security requirements contact PO to coordinate with the DPSM; see [Section 1.13 Security Requirements and Procedures](#).
2. Security for all radioactive materials in laboratories when unattended
3. Space for shielding waste containers
4. Appropriately sized laboratory and marshalling areas for reduction of storage and/or waste accumulation
5. Appropriate spill containment for all storage areas
6. Potential shielding requirements between adjoining or adjacent laboratory bench areas for high-energy beta-emitter radionuclides
7. Compensation for the additional weight required for lead shielding in the design of countertops and hoods if the laboratory is used for high-energy gamma-emitter radionuclides
8. Secure equipment alcoves for storage of radioactive materials
9. Security provisions in construction specifications (e.g., locks as part of the

integrated system to secure this equipment) when storing radioactive materials in refrigerators and/or freezers

10. Secure room for irradiator equipment, designed in collaboration with DRS

**D. Beta Barriers:** Beta barriers for shielding energetic beta emitters (P-32), often transparent plastic sheets, 0.95–1.27 cm (3/8–1/2 in.) thick, shall be provided to protect personnel in adjacent and close work areas.

**E. Ventilation Systems:** Ventilation systems used for controlling airborne radioactive discharges require the following:

1. Laboratory exhausts shall be manifolded into the regular building exhaust
2. Hoods for bulking radioactive materials shall have sampling capability
3. Mechanical room space shall be designed to provide for future additional filtration capability

If the facility requires additional hoods, specifically for the use of iodination techniques, then the exhaust from these installations shall be equipped with charcoal filtration and may additionally be equipped with HEPA filtration. A distinct installation shall be considered separate from the main exhaust system.

**F. Radioactive Airborne and Liquid Effluent Discharges:** DRS prohibits discharge of radioactive material into laboratory sinks. Provision shall be made in the design for installation of appropriate sampling probes for sampling capability to assess airborne and liquid effluent discharge streams, including main exhaust systems, sufficient to demonstrate compliance with the requirements of 10 CFR 20.1302. Liquid effluent monitoring can be accomplished by batch, composite, or continuous sampling prior to discharge into the sanitary sewer system. Design and construction considerations for airborne radioactive effluent monitoring shall include the following:

1. All systems for use with radioactive materials shall have the capacity to sample the airborne effluent being discharged, primarily gases and vapors.
2. Sufficient capacity shall be provided for sampling the combined discharge, specifically gases

and vapors, at a common point located inside the mechanical room downstream of the filters and upstream of exhaust fans.

3. Where iodination is performed in specific laboratories, those hoods shall be equipped with charcoal filtration and may additionally be equipped with HEPA filtration.
4. Airborne radioactive effluent monitoring systems shall be designed in accordance with ANSI Standard N13.1, Guide to Sampling Airborne Radioactive Materials in Nuclear Facilities (1969), specifically Appendix A, Guides for Sampling from Ducts and Stacks.
5. A single-nozzle sample probe shall be designed inside the air stream for sampling gas and vapors, as specified in ANSI Standard N13.1.

**G. In-Laboratory Standards:** Laboratory design considerations shall include state-of-the-art design considerations, as specified by ANSI, and other acceptable industry standards, such as the following:

1. National Council on Radiation Protection and Measurements (NCRP), Report No. 127, Operational Radiation Safety Program.
2. Hanson and Blatz, Radiation Hygiene Handbook.

**H. Walls and Floors:** Epoxy coatings, laminates, floor coverings, and protective coatings shall be utilized for ease of decontamination and to provide a protective coating that can be readily removed without extensive damage to the existing facility and surfaces.

**I. Sinks:** Sinks shall be either plastic composite or coated with epoxy or the equivalent to ease decontamination of surfaces. Stainless steel is also an option for sinks. Soapstone shall not be used.

**J. Air Filtration:** Air filtration systems (activated charcoal/HEPA filtration) shall be installed and tested in accordance with ANSI/American Society of Mechanical Engineers Standard N510-2007, Testing of Nuclear Air Cleaning Systems. The activated charcoal and HEPA filters shall be tested with current state-of-the-art methods and techniques for filter efficiency and compliance with technical specifications at the factory and after installation at NIH facilities.



**K. Fume Hoods:** Chemical fume hoods for radionuclide use shall be designed in accordance with all requirements and associated references in [Chapter 6: Mechanical Design](#).

A typical chemical fume hood designed for hazardous materials is acceptable as a radioisotope fume hood. The hood design shall include smooth, non-porous surfaces for ease of decontamination. The fume hood shall be constructed of materials that will not generate mixed waste if the surfaces and the construction materials interact with the radioactive materials. Refer to [Chapter 6](#).

**L. Vacuum Systems:** Vacuum systems shall be protected from contamination and exhausted to the exterior of the facility. Refer to [Chapter 12](#).

**M. Irradiators Utilized in Medical Research:** The DRS shall be contacted when designing/installing an irradiator. Irradiators are designed to contain significant amounts of radioactive material and therefore are designed with engineering controls, as well as adequate shielding to perform the necessary functions utilized in medical research. The following facility design parameters shall be evaluated and satisfied for the construction to adequately house this equipment:

1. Adequate structural integrity of floor loads given the amount of shielding and associated weight of this equipment
2. Adequate available means for moving this equipment to its location (e.g., loads on elevators and pathways)
3. Feasibility and preference to locate equipment on the lower floors of a facility (e.g., ground floor, basement, or subbasement) due to shielding requirements
4. Physical security measures for the room and/or facility housing the irradiator. No penetrations greater than .06 m<sup>2</sup> (96 in<sup>2</sup>) into irradiator rooms without DRS approval.
5. Electrical support to provide power to all required security systems including access control.

**N. Radiation-Producing Equipment and/or Machines:** The DRS shall be notified when there is any change

in the setup of radiation-producing equipment or machines. This includes purchase and installation of new equipment, changes in shielding, changes in the output of the radiation, or changes in usage of the unit. With respect to the use of radiation-producing equipment and/or machines, the following design guidance shall be used:

1. National Council on Radiation Protection and Measurements (NCRP) Report No. 102, Medical X-Ray, Electron Beam and Gamma-Ray Protection for Energies up to 50 MeV (Equipment Design, Performance and Use, 1989)
2. NCRP Report No. 151, Structural Shielding Design and Evaluation for Megavoltage X- and Gamma-Ray Radiotherapy Facilities, 2005
3. NCRP Report No. 147, Structural Shielding Design for Medical X-Ray Imaging, November 19, 2004

The documents referenced above shall be used by DRS to:

1. Implement an “as low as reasonably achievable” (ALARA) program to minimize radiation exposure to occupationally exposed individuals and the general public
2. Provide the appropriate design criteria as they relate to radiation-producing equipment and/or machines
3. Provide structural shielding requirements for any new installations or installations undergoing renovations or changes

The factors, workload, use, and occupancy as defined in the appropriate NCRP handbooks, shall be utilized to calculate and design the necessary shielding requirements. The annual dose-equivalent limit for design purposes shall be 10-mRem public exposure and 500-mRem occupational exposure.

**O. MRI:** With respect to the use of MRI devices, the following regulations and design considerations apply (questions and further information should be directed to DOHS):

1. U.S. Food and Drug Administration (FDA) regulation 21 CFR 892.1000, Magnetic Resonance Imaging

2. Security requirements for housing and enclosing the equipment
3. Warning placards, signs, and postings, which may also include barriers
4. Warning requirements for cardiac pacemakers as well as other prosthetic devices and/or equipment
5. Shielding requirements to minimize radiation exposure to electric and magnetic fields
6. Posting concerning electrical hazards
5. Warning placards, signs, and postings, which may also include barriers
6. Appropriate personal protective equipment warnings prior to entering and/or working with the equipment to mitigate and prevent eye and skin exposure
7. Shunt trip interlock with laser equipment or doors may be required if door is inadvertently opened while equipment is being operated

**P. Lasers:** With respect to the use of lasers, specifically high-power lasers, the following regulations and design considerations apply (questions and further information should be directed to DOHS):

1. FDA regulation 21 CFR 1040, Performance Standards for Light-Emitting Products
2. ANSI Standard for the Safe Use of Lasers, ANSI Standard 2136.1, 1986
3. Conference of Radiation Control Program Directors (latest edition)
4. Security requirements for housing and enclosing the equipment

A Class III laser system is a medium-pulse system requiring control measures to prevent viewing of the direct beam. Design and control measures emphasize preventing direct access to the primary or reflected beam. Safety eyewear is necessary and required with this class of laser. High-power lasers (e.g., CO<sub>2</sub> lasers) are classified as Class IV lasers in 21 CFR 1040. These lasers produce radiation so powerful as to cause injury with a direct or reflected exposure, even when the beam is scattered or diffused by a rough surface or smoke screens. Class IV radiation lasers emit more than 0.5 W continuous output. Laser facilities shall be designed to minimize the use of reflective/refractive surfaces to provide additional protection to occupational personnel.



# Section 1.12

## Integrated Pest Management

---

### Contents

- 1.12.0 Introduction
- 1.12.1 Integrated Pest Management
- 1.12.2 IPM Program Components
- 1.12.3 Facility Design Elements
- 1.12.4 Pest Management Consultation, Design Review, and Program Support
- 1.12.5 Pest Management Services During Construction

## 1.12.0 Introduction

**A. General:** This section describes the general requirements and specific goals for managing pest issues on NIH campuses. Pest control is a significant issue as pests are known to:

1. Carry disease organisms on or in their bodies
2. Cause physical damage to building facilities (by chewing/gnawing)
3. Contaminate and compromise the research environment

In order to provide safe, effective pest control that is compatible with the biomedical research environment, the DOHS Community Health Branch (CHB) has implemented Integrated Pest Management (IPM) programs in all NIH design and construction projects and throughout NIH workplaces. Professional entomologists on the staff of the DOHS manage these programs.

**B. Pesticides:** Traditionally, pest control consists of the general application of one or more pesticides. However, there has been a movement away from relying solely on pesticides to solve pest problems in response to public concerns over pesticide use, pesticide resistance, and the possibility that pesticide applications may contaminate the work environment and expose staff to pesticide residues.

**C. Long Term Prevention:** The reliance on pesticides as the sole means to correct pest problems is unacceptable in the NIH biomedical research environment. The NIH has implemented effective, long term prevention methods and strategies that work in unison with the building design and its use. Prevention of pest infestation in and around the NIH buildings contributes to creating a better work and research environment.

**D. Biotic Factors:** Pests are dependent upon biotic factors to provide nourishment and moisture and abiotic factors to provide harborage and ingress into buildings. Through proactive steps taken during building planning, design, construction, and commissioning, resources for pests are minimized, thus diminishing pest infestation during the building's functional life cycle.

## 1.12.1 Integrated Pest Management

Integrated pest management (IPM) is a safe and effective way to control pests. IPM is proactive in preventing pest problems, not reactive to an infestation, especially in ARFs. IPM discourages unnecessary pesticide use and generic prescriptive pesticide treatments. Each IPM program is specifically designed to meet the individual needs of the area serviced and is a continuing program to manage the environment where pests live and to meet future pest management needs.

The IPM program focuses on designing new projects that do not create conditions that encourage pests, and that minimize pesticide applications by reducing the amount of food, water, and harborage to pests.

## 1.12.2 IPM Program Components

Improvements in facility design and construction can significantly assist with maintaining good sanitation, housekeeping, and pest prevention. The basic components of an IPM program instituted during the design and construction phases significantly minimizing pest infestation of buildings during construction are:

**A. Facility Design:** Proactive approach to facility designs not contributing to the harborage of pests

**B. Structural Repairs:** Performance of small repairs that exclude pests

**C. Sanitation:** Proper sanitation on the construction site, reduction of clutter and pest harborage, and banning cellulose-type fill and/or debris

Operational elements implemented during construction and facility occupation include:

**A. Monitoring:** Regular surveillance of an area using traps, visual inspections, interviews with staff, and surveys to determine if a pest problem exists; the location and size of the pest infestation; and conditions contributing to pest problems

**B. Communication:** Staff cooperation in correcting conditions that contribute to pest problems

**C. Record-Keeping:** Data monitoring of pest numbers and observations on housekeeping and structural deficiencies

**D. Pest Control without Pesticides:** Pest exclusion, trapping, screening, and caulking used as effective, long term methods of pest prevention and applied with a high degree of safety and effectiveness

**E. Pest Control with Pesticides:** Pesticide application using the safest, most effective methods, and only where needed

**F. Program Evaluation:** Data/observations monitoring periodically summarized and reviewed to evaluate program effectiveness

**G. Safety:** Significant reduction of the use of pesticides through IPM and emphasis on the use of more permanent non-pesticidal control practices, minimizing the potential of exposure to pesticides by the research environment and NIH staff

**H. Quality Assurance:** Technical oversight providing an objective, ongoing evaluation of program activities and effectiveness

**I. DOHS CHB Involvement:** CHB management of IPM programs in biomedical laboratories and ARFs, with involvement during the planning, design, and construction phases of new construction and alteration projects. The PO and design team shall involve the CHB early during the planning and design process for any project to obtain input on proposed designs from the pest-management perspective.

---

### 1.12.3 Facility Design Elements

Buildings shall be designed and constructed to promote cleaning. This entails employing designs and materials that minimize gaps, voids, and inaccessible spaces. For specific information on sealing cracks, crevices, and voids in surfaces see [Appendix L: Sealant Table](#). Construction materials shall be durable and chosen for the proper application to maintain building integrity to avoid gaps, holes, and voids where debris can

accumulate and pests can harbor. General components of facility design and construction that impact an effective pest prevention program are:

**A.** Overall facility design and construction, including the materials and construction detailing and the equipment and construction processes used to build the facility. Facility components and layout shall minimize points of pest ingress and harborage and optimize accessibility for cleaning, sanitation, and pest inspection.

**B.** Housekeeping as it relates to design and sanitation, throughout the surrounding building area and inside the facility.

**C.** Pest management service implemented during construction.

**D.** Facility durability and sustainability over the life cycle of a facility, changes in the envelope, interior layout and equipment, and animal facility use and programs have a direct influence on pest activity in and around a facility.

Specific areas of importance are:

1. Staff support areas, including break rooms, locker rooms, and administrative and conference space
2. Shipping or receiving areas (including loading dock and storage facilities)
3. Personnel entry points
4. Areas with solid waste management or recycling activities
5. Landscaped areas and exterior lighting

---

### 1.12.4 Pest Management Consultation, Design Review, and Program Support

The PO and the A/E shall contact the Community Health Branch (CHB) during the early planning stages of any design project to ensure that the design addresses all areas relative to pest management, including:

**A. Design Concept:** Structural/design components (ranging from exterior design elements such as ledges to open or hollow voids in interior case work) that pose a potential or known pest problem.

**B. Facility Fit-Out:** Materials and equipment considered undesirable or unacceptable by the IPM.

**C. On-site Consultation:** Technical support by CHB staff provided during site visits and inspection during all phases of planning, design, construction, and renovation.

**D. Pest Management Services Oversight:** Maintaining pest surveillance and control programs during all phases of construction with DOHS review and approval of all IPM service plans and inspection of all pest-management services delivered by construction contractor personnel to ensure efficacy and IPM program quality.

---

## **1.12.5 Pest Management Services During Construction**

IPM services for the control of pests are required on all NIH construction sites during all phases of construction.

# Section 1.13

## Security Requirements and Procedures

---

### Contents

**1.13.0 Introduction**

**1.13.1 Security Role/Responsibilities**

**1.13.2 Applicability**

**1.13.3 References**

**1.13.4 Procedures**

**1.13.5 Additional Requirements**

**1.13.6 Nondisclosure Warning**

## 1.13.0 Introduction

This section outlines requirements for security in and around NIH facilities. For project specific information contact the Division of Physical Security Management (DPSM).

### 1.13.1 Security Role/Responsibilities

A. The Division of Physical Security Management (DPSM) is responsible for ensuring that all NIH owned or leased facilities are in compliance with federally mandated physical security requirements and approved security systems that mitigate current and emerging threats. Physical security systems include, but are not limited to:

1. Access control devices such as card readers, biometric devices and secure locking systems
2. Security lighting, electronic surveillance and video recording systems
3. Intrusion detection and alarm systems
4. Blast mitigation techniques
5. Pedestrian and vehicle barriers
6. Facility and perimeter protection measures
7. Other specialized security systems

B. The A/E and contractor shall:

1. Ensure new construction and renovation projects are in compliance with NIH physical security related policies and guidelines and other applicable federal physical security policies and requirements.
2. Provide cost effective strategies to enhance project security as well as overall NIH security while maintaining the integrity and compatibility of NIH's existing security systems and infrastructure.
3. Coordinate and consult with DPSM to identify physical security program requirements for the project.

4. Ensure appropriate DPSM participation in meetings as early as possible to identify physical security requirements to be incorporated into the scope, design, and execution of the project.
5. Engage with DPSM throughout project planning, design and execution to make certain project security needs are met efficiently and effectively.
6. Incorporate DPSM guidance and recommendations from meetings, the ORF Permit Review Process, project commissioning or acceptance, etc. into the project design deliverables and project execution.
7. Assist with ORF's Permit Review Process in identifying, coordinating and approving physical security requirements.
8. Obtain all necessary security related permits or approvals prior to performing any design or construction activities (e.g., photograph or video capture, use of powder actuated fasteners, etc.) to ensure compliance with DPSM policies.
9. Control and protect security sensitive information, specifications, drawings, capabilities, etc. either provided by DPSM or generated by the project and share only as necessary. Destroy these items when no longer needed.

### 1.13.2 Applicability

A. The DPSM Policies and Design Requirements (PDR) contain specific security requirements, including critical security systems, and shall apply to all NIH owned and direct leased facilities to which the *DRM* is applicable. See [1.13.6 Nondisclosure Warning](#).

B. Any NIH organization that is planning the alteration, new construction, repair-by-replacement, renovation, or major equipment installation at NIH owned or NIH direct-leased facilities must coordinate jointly with the ORF and DPSM. POs and managers should consult with DPSM as early as possible during the initial project planning stages. Any additional contract impacts and unplanned physical security costs resulting from not receiving prior approval from DPSM will be borne by the offending organization.

C. The security requirements outlined in this *DRM* are not applicable to General Services Administration (GSA) leased facilities. The Federal Protective Service (FPS) oversees GSA lease facilities and is responsible for providing risk assessments and physical security requirements for such facilities. Upon request, the DPSM may provide consultative support to the NIH customer on FPS physical security requirements and when NIH is renovating space under PO authority in a GSA lease.

---

### 1.13.3 References

New and emerging threats within the United States necessitate periodic updates to federal security requirements. Therefore, physical security requirements and guidelines unique to the mission of the NIH include, but are not limited to:

1. DHS Interagency Security Committee (ISC) Standards: The Risk Management Process for Federal Facilities
2. NIST Federal Information Processing Standards (FIPS)
3. NIH MasterSPEC
4. NIH Policy Manual Chapter 1381 – Physical Security Project Requirements for NIH Owned and Leased Facilities
5. DPSM Policies and Design Requirements (PDR)

Necessary sections and or appendices of the DPSM PDR will be provided to the project when appropriate through coordination with DPSM.

---

### 1.13.4 Procedures

#### A. Pre-Project Planning Phase:

1. All alterations, new construction, repair by replacement, renovation, major equipment installation, or adjustments to security features, in NIH owned or NIH direct-leased facilities must be coordinated with ORF and DPSM prior

to actions being taken that impact existing physical security.

2. DPSM will identify physical security requirements for each project during the Pre-Project Planning Phase which will be further developed as the design matures.

#### B. Planning Phase:

1. The consideration of security components and incorporation of required elements early in the planning and design process is more economical than the incorporation of security elements late in design or during construction. Due to the unique security requirements of each project, the A/E shall contact the NIH DPSM through the PO in the early planning stages to ensure compliance.

2. The planning phase may include the development of a POR, FPAA, bridging or other documents based on the type of procurement action anticipated.

When applicable, DPSM will endorse the FPAA, POR or other planning documents to validate the physical security requirements that are included in the project.

3. Planning documents must be approved by customers/stakeholders prior to the start of the design phase.

#### C. Design Phase

1. DPSM will adhere to the ORF Permit Review Process in coordinating project physical security requirements with the design teams.
2. DPSM will perform a security assessment, develop recommendations, review the scope of work (SOW), and coordinate proposed actions with the customer and other stakeholders on an as needed basis. The SOW may include approved equipment and functionality; evaluation and other applicable project security requirements.
3. The A/E shall incorporate the DPSM identified security requirements as well as the ISC standards into the project design and documentation. DPSM will review the design documents



in accordance with the ORF Permit Review Process to ensure the project security requirements are incorporated into the design.

4. For designs/projects that impact existing or include new security systems or features, final design submissions must be approved by DPSM prior to being released for bid. If a design is amended during the advertisement/award period impacting the physical security requirements, DPSM must review the scope of the amendment to ensure it remains in compliance with federal security requirements.
5. For lease replacement through the General Services Administration (GSA), Institutes and Centers may request DPSM to serve as a security consultant. In such cases, DPSM will offer recommendations and coordinate activities with the Federal Protective Service as necessary.
6. When security systems or equipment are to be added, modified either temporarily or permanently, or integrated with existing systems by a project, the A/E shall coordinate with DPSM to ensure project security systems or hardware are compatible with existing NIH security systems, infrastructure, and processes.

#### D. Construction/Renovation/Project Completion Phases:

1. **Change Orders:** The ORF PO will notify DPSM of change orders affecting the physical security features or requirements. DPSM shall review each physical security change and provide comments within the schedule established for Government reviews.
2. **Ongoing/Periodic Security Assessments:** DPSM will conduct periodic security risk assessments and systems troubleshooting assessments during ongoing construction, renovation, or major equipment installation projects.
3. **Final Security Assessment:** All construction, renovation, or major equipment installation projects that impact existing, or provide new security features/systems, must be approved by DPSM prior to closeout/completion of the project.

4. The A/E and/or contractor shall verify that the project security systems, features, hardware, etc. are installed, tested and commissioned in accordance with the final, approved design and any approved change orders as applicable.

---

### 1.13.5 Additional Requirements

**A. Equipment:** All security systems, including hardware and software, should be purchased at the latest possible time to maximize the length of warranties and to avoid equipment becoming obsolete prior to installation.

**B. Contractor Tools and Instruments:** The contractor must submit a request to the PO to use Explosive Powder Actuated Tools (EPAT) to perform work under the contract. The PO shall provide a signed copy of the approved permit to the Contractor/authorized/designated Project Manager (PM) responsible for the project and tools. When requested by NIH Security, the contractor shall provide a register of the individuals with access to the EPAT's, the secure storage locations if kept on the NIH premises, and operator training certifications.

**C. Project Notifications:** Contractors must notify the DPSM initially through the PO for all security related information.

**D. Photographing and Video Recording:** When photographic or video recording documentation is necessary for the project, contact the PO and DPSM for necessary approvals prior to taking photos or recording video.

---

### 1.13.6 Nondisclosure Warning

**A.** The DPSM PDR contains law enforcement-sensitive physical security design and construction criteria and standards for NIH buildings and facilities. Disclosure of this data to other than Federal officials or contractors without a specific need to know may compromise security of the facility and its occupants. Portions of the document, and the criteria, references, codes, and standards contained therein will be made available only to those Federal officials and contractors, contract

employees, and identified consultants who have a direct need for the information to design a specified project. Precautions shall be taken to safeguard and control distribution of any portion of the PDR, and any individuals provided copies shall assume responsibility for ensuring that the information is kept secure. See NIH Division 1 Specification Section 01355 for an outline of procedural requirements.

**B.** The DPSM PDR is exempt from mandatory public disclosure under provisions of the Freedom of Information Act (FOIA), paragraph 5 USC 552(b) (2). Information contained in the document and the included tables shall be protected from potential adversaries. Users may classify the tables following Classified National Security Information contained in Executive Order 12958 and its Implementing Directives.

# Section 1.14

## Inspection, Acceptance, Activation, and Occupancy

---

### Contents

- 1.14.0 Introduction
- 1.14.1 Critical Facility Risk Assessment and Certification
- 1.14.2 Inspection and Acceptance
- 1.14.3 Occupancy
- 1.14.4 Operations and Maintenance Manuals

## 1.14.0 Introduction

**A. General:** In this section, guidance that facilitates transitioning from the construction phase to the beneficial use and operations of a construction project by the user is provided. Topic areas of particular significance to effective facility activation include inspection and acceptance, warranties, training, documentation in operations and maintenance manuals, and occupancy.

**B. Occupancy:** The NIH may take beneficial occupancy or use after substantial completion of a facilities project is achieved. Potential risks, impacts, and effects shall be carefully considered when deciding whether to occupy or utilize a portion of building prior to substantial completion of the whole project.

**C. Warranties:** An effective warranty management program shall be in place to enforce active material, equipment, and workmanship warranties for the benefit of the Government.

**D. Material Safety Data Sheets (MSDSs):** MSDS shall be required from the contractor in a separate binder. A MSDS is designed to provide workers and emergency personnel with procedures for handling or working with a particular substance. MSDSs include information such as physical data (melting point, boiling point, flash point, etc.) toxicity, health effects, first aid, reactivity, storage, disposal, protective equipment, and spill/leak procedures. These are of particular use if a spill or other accident occurs.

### 1.14.1 Critical Facility Risk Assessment and Certification

Critical facilities require that a Risk Assessment (RA) be performed prior to design to ensure all risks are identified and mitigation recommendations provided to meet the required regulations, standards and facility attributes.

The RA shall use appropriate methodology methods/tools for their analysis. These tools include Preliminary/Process Hazard Analysis (PHA), Hazard and Operability Studies (HAZOPS), Fault Tree Analysis (FTA), Failure Mode and Effects Analysis (FMEA) and Hazard Analysis and Critical Control Points (HACCP).

Certification is the systematic review of all safety features, design elements, operational modes and processes associated with a critical facility (e.g., patient care, pharmaceutical preparation, biocontainment) to validate that all facility controls and required practices (engineering controls, personal protective equipment, building and system integrity, standard operating procedures (SOPs), administrative controls such as documentation and record retention systems) are in place to minimize, to the greatest extent possible, the risks associated with operations.

To ensure compliance certification, the evaluation process must be ongoing throughout the project and the A/E shall coordinate all requirements necessary at the design stage in collaboration with the PO, DOHS, DTR and other entities related to the facility type to achieve certification.

Certification should be conducted before initial operation and subsequently on an annual schedule or after a program change, renovation or replacement of any engineering controls that may affect the operating environment of the facility.

For critical facilities related to current Good Manufacturing Practices (cGMP), DTR will work with the design team to identify regulatory requirements and assist with their compliance.

### 1.14.2 Inspection and Acceptance

**A. Quality Control:** Contractors are required to maintain adequate quality control systems and perform such inspections that ensure that the work performed under the contract conforms to contract requirements. The contractor shall maintain complete inspection records and make them available to the Government.

**B. Responsibility for Conformance:** The activities of any inspector, commissioning agent, or verification/validation personnel does not waive the A/E of the responsibility of compliance with the *DRM* in preparation of the contract documents or the contractor from responsibility of compliance with the contract documents.

**C. Inspection and Testing:** All work shall be conducted under the general direction of the CO and is subject to Government inspection of and testing at all places and at all reasonable times before acceptance to ensure strict compliance with the terms of the contract. Government inspections and tests are for the sole benefit of the Government and do not relieve the contractor of responsibility for providing adequate quality-control measures, nor relieve the contractor of responsibility for damage to or loss of the material before acceptance, constitute or imply acceptance, or affect the continuing rights of the Government after acceptance of the completed work under the contract.

**D. Inspections:** The presence or absence of a Government inspector does not relieve the contractor from any contract requirement, nor is the inspector authorized to change any term or condition of the contract without the CO's written authorization.

**E. Inspection Reports:** Inspection reports regardless of the pass or fail status, shall be copied to the PO and CO.

**F. Work Adjustments/Acceptance:** In accordance with FAR 52.246, the contractor will, without charge, replace or correct work found by the Government not to conform to contract requirements, unless in the public interest the Government consents to accept the non-conforming work with an appropriate adjustment in contract price. The contractor will promptly remove rejected material from the premises. If, before acceptance of the entire work, the Government decides to examine already completed work by removing it or tearing it out, the contractor, on request, shall promptly furnish all necessary facilities, labor, and material. If the work is found to be defective or non-conforming in any material respect due to the fault of the contractor or its subcontractors, the contractor shall defray the expenses of the examination and of satisfactory reconstruction. However, if the work is found to meet contract requirements, the CO shall make an equitable adjustment for the additional services involved in the examination and reconstruction, including, if completion of the work was thereby delayed, an extension of time.

**G. Contract Requirements:** The CO shall accept, as promptly as practicable after completion and inspection, all work required by the contract that the CO determines meets contract requirements or that portion of the work the CO determines can be accepted

separately. Acceptance by the CO shall be final and conclusive except for latent defects, fraud, gross mistakes amounting to fraud, or the Government's rights under any warranty or guarantee.

**H. Basic Warranties:** It is in the best interest of the Government to have the entire construction project warranted. OPDIV COs shall insert in full text, FAR clause 52.246-21, Warranty of Construction, into construction contracts as well as design-build contracts. This clause provides for the following: The contractor, whether a construction contractor or a design-build contractor, essentially warrants that work performed under its contract conforms to the contract requirements and is free of any defect in equipment, material, or design furnished, or workmanship performed by the contractor or any subcontractor or supplier at any tier. The standard warranty period extends usually for one year from the date of final acceptance of the work. Contractors shall provide warranties in a separate binder with points-of-contact names, addresses, and all applicable phone and fax numbers.

**I. Adjustments of Basic Warranty/Guarantee Period:** The contractor may request an adjustment in a warranty period based on completion of the work and use of the equipment and/or system by the Government. Systems that are utilized on a seasonal basis must be tested and used through a complete annual load cycle. For example, if the final inspection were held in the fall, the air conditioning system would not be properly tested under full load until the following air conditioning season. The contractually specified warranty period does not apply to latent defects. The timeframes in which remedies for latent defects are possible is usually much longer than the standard one year warranty.

**J. Manufacturers', Subcontractors', and Suppliers' Warranties:** The A/E generally specifies product performance characteristics that result in warranties. In many cases, these warranties are industry standards. All warranties express or implied, from subcontractors, manufacturers, or suppliers for work performed and materials furnished are enforceable under the contract. The Contractor is required to obtain all warranties that would be given in normal commercial practice; all warranties are to be executed, in writing, for the benefit of the Government, and all warranties are to be enforced for the benefit of the Government.

The management of the warranty process should be passed to the maintenance staff operating the facility. This group of individuals identifies the actual problem through troubleshooting processes and determines if it is in fact a warranty issue. Then appropriate action and follow-up can occur as well as a documented history. This staff also works with the CO to resolve any items in dispute and provide any necessary technical information to the CO for enforcement of the warranty requirement.

---

### 1.14.3 Occupancy

**A. Normal Occupancy:** Generally, the facility is occupied after final acceptance.

**B. Beneficial Occupancy:** The Government has the right to take possession of or use any completed or partially completed part of the work. Before taking possession of or using any work, the CO should furnish the contractor a list of items of work remaining to be performed or corrected on those portions of the work that the Government intends to occupy. The CO's list of any item of work shall not relieve the contractor of responsibility for complying with the terms of the contract. The Government's possession or use shall not be deemed an acceptance of any work under the contract. Any unfinished work in areas to be occupied shall not cause major disruptions to the occupancy.

**C. Government Responsibility:** When beneficial occupancy is affected prior to full acceptance, a careful inspection of the area to be occupied shall precede such occupancy. Because the Government would be responsible for restoration and repair of damage resulting from the beneficial occupancy, records of conditions in both photographic and narrative form at the time of occupancy are essential.

**D. Responsibility From Use:** Although the Government has such possession or use, the contractor is not relieved of the responsibility for the loss of or damage to the work resulting from the Government's possession or use. If possession or use by the Government prior to substantial completion of the entire project delays the progress of the work or causes additional expense to the contractor, an equitable adjustment should be made in the contract price, the time of completion, or both, and the contract should be modified in writing accordingly.

**E. Occupancy Agreements:** The CO shall prepare an appropriate letter to the contractor setting forth the extent of the occupancy and its effective date and time. Lists of deficiencies and omissions in the occupied area should be included. In addition, when partial occupancy is required, an agreement with the contractor must be executed that delineates facility service responsibilities (maintenance, utilities, security, etc.).

---

### 1.14.4 Operations and Maintenance Manuals

Operations and maintenance (O&M) manuals are essential to the activation and long term care of new HHS facilities. Provisions in the construction or design-build contracts shall require the development of a consolidated operations and maintenance manual for the entire facility in both hard copy and electronic copy. A copy of the manual should be kept and maintained by ORF's facility management and operations and maintenance organizations. The manual shall include:

1. A copy of all warranties
2. As-built/record drawings of the project
3. A list of all training requirements and a roster of trainees
4. All information necessary to optimize operations and maintenance of facility equipment and systems, including instruction manuals and training videos
5. Specific operational protocols for special and highly sophisticated equipment
6. Standard operating procedures and parameters
7. Parts lists and vendors
8. Commissioning results as a baseline for validation and facility performance expectations
9. The O&M shall also contain the facility numbers assigned the equipment.

# Section 1.15

## Common Engineering Systems' Requirements

---

### Contents

**1.15.0 Introduction**

**1.15.1 Common Engineering Requirements**

**1.15.2 Preservation of Service**

**1.15.3 Technical Requirements of Systems' Planning**

**1.15.3.1 Penetrations**

**1.15.4 Supplemental Technical Requirements for Animal Research Facilities**

**1.15.5 Supplemental Technical Requirements for High Containment Facilities**

**1.15.6 Risk Assessment, Systems Failure & Disaster Mitigation**

**1.15.7 Failure Corrections and Root Cause Analysis**

**1.15.8 Specification of Contractor Qualifications**



## 1.15.0 Introduction

This section addresses issues generally applicable to engineering systems that are regulated, guided by, and used in conjunction with this and other sections of the *DRM*.

Properly designed research facilities which support the ever changing needs of science require extensive planning and forethought. Designers unfamiliar with research facilities, and in some cases the needs of the particular science, will often overlook the complexity behind the architectural and engineering systems and importance of their conscientious design to safety, usability of the facility, and to protect the research from unintended variables, risks to science, and extensive life cycle costs and disruptions.

When planning a research facility the A/E should be in regular contact with project stakeholders, and designs must be thoroughly reviewed for conformance with the *DRM*. It is the A/E's responsibility to have sufficient understanding of the type of research being conducted, the associated risks, *DRM* requirements, and an understanding of how to balance the individual project requirements with future flexibility and adaptability. In order to 'right-size' both space and MEP systems the A/E should spend extensive time evaluating space utilization of the researchers (how much time is spent at the bench versus office, possible shared equipment between researchers, etc.) and further the appropriate spare capacities and arrangement of MEP systems.

---

### 1.15.1 Common Engineering Requirements

**A. General:** Systems shall be designed (and installed) to preclude or minimize potential impact to research, health care or disruption to animals. The arrangement of systems shall ensure a maximum of reliability, operational flexibility, and capacity for renovation without affecting other areas or interfering with research; allow service to occur without interfering with research; consider service access restrictions and security requirements; and shall minimize potential for disruption due to plausible single point failures and routine maintenance. Appropriate design consideration shall be given

to ensure system maintainability, economy, and energy-efficiency, and adaptability to future facility modification or expansion. Health/safety and avoidance of impact to research (including avoiding disruption to clinical operations and animal research areas) are foremost criteria.

**B. Critical Applications:** Where necessary for critical applications, especially for life-safety and in large facilities, redundant system arrangements shall be segregated/remote-located to protect from catastrophic failures, or major local conditions (e.g., steam or utility, rupture, power loss, flooding, fire, etc.). The arrangement of such systems shall be as approved by NIH and evaluated in initial design concepts.

**C. Planning for Future:** Where phased work is planned or known, major infrastructure (such as underground utilities and space in mechanical rooms) shall be planned so as to minimize duplication of costs, disruptions, and to the extent possible to minimize need for loss of program areas associated with poor planning. Limitations with regards to these issues shall be discussed with the NIH during predesign to facilitate approval for planned approaches and accommodation.

**D. Future Redundancy/Capacity, and Documentation:** Designs shall accommodate future program renovations, expansions, serviceability, and changes of equipment. System designs must consider future capacity allowances, future expansion, and likely renovation strategies, including forethought in the sizing and arrangement of utility services, main risers, and major branch lines, as well as equipment-room space planning forethought and interdisciplinary coordination so as to minimize future disruptions. The design intent shall be sufficiently documented, including explanation of provisions, spatial planning, and sizing criteria to facilitate projected future requirements as well as redundancy and capacity arrangements.

**E. Biosecurity Requirements:** Designs shall consider biosecurity requirements associated with each application. Systems and equipment shall be located only in secured areas compliant with facility biosecurity requirements and the site specific risk assessment. Designs shall be submitted to the DOHS BioRisk Program for Select Agent Laboratories. DOHS will approve the design of biosecurity controls.

***Rationale:** Thoughtful consideration of biosecurity principles, including but not limited to those related to animal safety, cross-contamination control, biosafety, tampering and vandalism, and other factors are primary and mandatory elements of each system design.*

**F. Special Requirements:** In laboratory and animal research facilities, the selection of materials and installation methods shall incorporate special requirements unique to individual program areas, such as consideration of magnetic fields, special material restrictions, shielding requirements, washability, moisture and chemical exposure, etc., in accordance with equipment and functional operation requirements and installation location. Manufacturer equipment site planning guides shall be reviewed for scientific equipment and coordinated with *DRM* requirements.

**G. Disruption:** Equipment and utilities shall be designed and installed to preclude noise, vibration, odor, or other adverse impacts to clinical, research, or animal facilities beyond acceptable limits.

**H. Service Access:** To the extent possible, systems shall be arranged and access provided such that service access for building infrastructure may occur without requiring the entrance of maintenance personnel/contractors into the laboratory or animal holding rooms. Careful consideration shall be made to comply with this requirement for items including but not limited to valves, cleanouts, motors, controllers, pumps, central systems, drain points, etc. Access provisions shall be arranged to ensure biosecurity and safety requirements, and to avoid access of personnel into hazardous areas. Access for utility services shall not be made from computer, data center, electrical, surgical, aquatic, imaging, high containment, or other highly sensitive spaces. The location and use of access for the intended purpose must not result in an undue hazard to the facility, research, or personnel.

Access doors, cabinets, or panels shall be provided for access of all concealed controls and appurtenances. The use of access doors and panels shall be minimized to the extent possible in sensitive spaces, including spaces with special sanitary or pest control considerations, and wet areas (such as areas subject to hose spray or wash downs). Where access doors or panels are required

in sensitive spaces, special gasketed, piano-hinge type non-corrosive units (typically stainless steel) are required. Access doors, cabinets, and panels if installed in rated walls or ceilings shall be selected to maintain the required fire rating.

***Rationale:** Entrance into laboratories and sensitive spaces by contractors and maintenance personnel can be both disruptive and hazardous. In some cases, service components for the program space may need to be located within the program area; however, it is the intent of the *DRM* that these generally be located outside the space (such as in interstitial areas, where provided). Service components for system mains, other laboratories, and other program areas should not be located within a lab or animal space. Access doors and panels rarely maintain tight seals, especially after repeated openings.*

**I. Coordination with Equipment Vendors, Planners, and Manufacturers:** The A/E shall carefully evaluate vendor and specialty consultant drawings and actual equipment installation requirements to provide proper systems in conformance with the *DRM*. The A/E shall not rely only upon directions, planning sheets, or equipment schedules of vendors and manufacturers. Where a conflict or concern is noted, coordinate to ensure compliance with all requirements of equipment, codes, and the *DRM*.

***Rationale:** It is not uncommon for generic utility data to be provided by lab, food service, veterinary or specialty equipment vendors and manufacturers which may or may not necessarily meet the requirements of the *DRM* or applicable codes and standards. The A/E must therefore review and independently determine proper services and connection methods and coordinate with other vendors.*

**J. Floor Penetrations and Safing Membranes:** Penetrations through floors shall be sealed, whether concealed or exposed. Penetrations for floor drains, floor sinks, troughs, and similar components shall be designed to maintain structural strength and load ratings at the penetration, as well as water-tight characteristics, including as required to protect from condensation

(where applicable). The use of box-out arrangements for drains and troughs is not recommended and may only be acceptable for non-containment, non-critical areas, where keyed into the slab and water-safed beyond all seams, and designed to maintain integrity permanently. Use of corrosion resistant safing membranes (whether liquid or sheet type) is required for floor penetrations through potentially wet areas and whenever above sensitive spaces (including mechanical rooms, aquatics spaces, food service, and above ground ARF areas).

**K. Abandoned Infrastructure:** Facility renovation projects often cause major changes to existing infrastructure, assemblies, and utilities, resulting in portions of a building's existing infrastructure being disconnected or rendered nonfunctional. This issue can manifest itself as abandoned piping, conduit, ducts, or similar materials and architectural features such as door and window openings, flooring and ceiling systems, etc. During the design and investigation of a project the A/E shall review the area of work and whether existing building infrastructure may become abandoned as part of the project. The A/E shall note on plans and/or specifications that all disconnected and nonfunctional infrastructure, assemblies, or utilities shall be removed; i.e. abandoned branch piping removed back to the main, unused conduits removed, door and window frames removed, etc. Additionally, the A/E shall include notes requiring the contractor to notify the PO of any found abandoned utilities or infrastructure during a project's construction.

---

## 1.15.2 Preservation of Service

**A. Renovation Projects:** In renovation projects, whenever connections are made into existing systems to serve new equipment, additions, or renovated areas, the A/E shall ensure that the existing system will not be adversely affected, contaminated, disrupted, or in any case fall below the standards of code or *DRM* requirements as a result of the new work.

**B. Tapping of Services:** The A/E shall specify that tapings shall be made only by qualified personnel following appropriate procedures so as to protect the facility and maintain safety, including any necessary purging of lines and verification and reverification of safe conditions immediately before work is conducted.

**C. Capacity Assessment and Effect on Existing Services:** Effect on the capacity of existing services shall be evaluated prior to extensions of services and as required for accurate calculation. This may require the A/E to study existing infrastructure and systems capacity far beyond the actual planned point of connection to ensure adequacy, including but not limited to investigation of record drawings and surveys, and/or monitoring. Provision of meters and data logging at appropriate strategic locations and monitored over sufficient duration with a subsequent evaluation of data/loading assessment shall be considered along with other appropriate engineering assessment, especially where all spaces may not be accessible or documents may not be available or reliably current.

**D. Backfeed Plans:** Backfeeds of appropriate fluid quality shall be provided where necessary to maintain services. Tap plans shall be appropriately coordinated to mitigate potential disruptions and impact to research. Backfeeds are not permitted in hazardous services or where the arrangement could induce any safety hazard.

**E. Excavation:** Prior to any excavation, underground services shall be reliably located and marked above ground and approval obtained for the date of excavation activities by the PO. Where local utility marking services are not available on Federal Property, an independent marking contractor should be provided. An appropriate risk mitigation plan shall be made where work is near any hazardous piping or services to any clinical facility, research laboratory building or animal research facility (ARF), so as to minimize damage and ensure safety. The A/E shall specify for the contractor to include development of an action plan to facilitate immediate restoration of service in the event of any breach, prior to undertaking any excavation activities. Such action plan shall include, but not be limited to availability of personnel, materials, and backfeed provisions, as well as in-place contact procedures with facility and emergency response personnel in the event of an accident or unplanned line damage.

**F. Systems Integrity Control Plan:** The A/E shall confirm with the PO to ensure compliance with any Systems Integrity Control Plans, Approval to Tap Plans, Utility Moratoriums, etc. No modifications may be made to high purity water, animal drinking water, medical gas, biowaste, high containment vacuum, hazardous exhaust, pharmaceutical systems or other systems that

may be sensitive to contamination or potentially hazardous without written approval from the PO to proceed. Approved work shall be conducted to maintain system cleanliness and integrity.

### 1.15.3 Technical Requirements of Systems' Planning

**A. Coordination and Space Planning:** Systems shall be properly coordinated with other disciplines and structure early in predesign and throughout the design process to ensure required utilities arrangements are maintained and provided with organized and appropriate service access.

**B. Equipment Variability/Flexibility:** Systems shall be designed with appropriate consideration of variables between manufacturers and equipment options, so as to maintain flexibility for changes during and after the design.

**C. System Loads:** System loads shall be confirmed and systems properly adjusted as design progresses. The A/E shall not rely on preliminary estimated loads or other invalidated data for any system sizing.

**D. Systems Capacity:** Unless specified otherwise in the DRM, primary equipment, building service utilities shall be sized to provide 20% overage beyond actual peak design loads to allow for increased future demands and density compression, separate from any known expansion. When sizing and selecting connected equipment, the A/E shall utilize an efficient capacity split and controls arrangement to provide required redundancy and overage while still maintaining efficient operation for the normal-operating load profile. Provisions for known future expansions are made on a project-by-project basis. For office and non-critical spaces with prior approval of ORF, overage may be reduced to 10%.

**E. Electrical Component Location:** Electrical components, motors, and controls shall be elevated above the floor and on housekeeping pads, and shall not be located within equipment containment sump, diking, or in areas where subject to water spray, water pooling, similar safety hazards or risks of failure. Where electrical equipment must be located in areas subject to water spray,

wash down, wet location duty is required and shall be coordinated with requirements of [Chapter 10: Electrical Design](#), NEMA, and requirements of NFPA-70.

**F. Grounding:** All conductive piping systems shall be properly bonded to an appropriate grounding electrode system.

**G. Electrical Coordination:** The A/E shall appropriately differentiate between redundant (or standby) equipment demands and loads produced from normal operation when coordinating with electrical disciplines. Equipment capability to accommodate the 20% overage allowance shall be considered as part of routine normal loads. Where equipment must operate in simultaneous operation (e.g., normally at reduced loads and in some cases under full load) ensure electrical has been appropriately coordinated and systems commissioned for such conditions.

***Rationale:** It is imperative that the A/E provide realistic design calculations following proper engineering methods. The intended 20% overage is the value that should be available upon the completion of construction, with fully loaded systems under proper operation, not as a safety factor for poor engineering or lack of proper design-construction coordination. Similarly, it is not intended to be a safety factor applied on top of other safety factors, but rather a value that shall be applied to actual peak system loads. The purpose of this 20% allowance is to facilitate unknown demands upon the infrastructure that occur during the typical facility life cycle, inclusive of reasonable changes in program density within the same footprint, demand changes due to advances in technology and scientific method, and minor programmatic changes. It is not intended to serve as load allowances for expansion of building footprint or major programmatic changes, and where such expansion is anticipated, the associated loads and connection points shall be carefully planned and documented.*

**H. Existing Systems:** Whenever connections are made into existing systems to serve new equipment, additions, or renovated areas, the A/E shall ensure the existing system will not be adversely affected or in any case fall below the standards of code or DRM requirements



as a result of the new work. This may require the A/E to study existing infrastructure and systems capacity far beyond the actual planned point of connection to ensure adequacy.

**I. Utility Sizing:** If a major utility service is required for a project but is not present, the utility sizing/capacity shall be approved by ORF. In many cases this may require upsizing of services beyond those required for an individual project.

**J. Underground Utilities:** Provision of a geotechnical report by a design professional is required for all new and major projects where underground utilities will be buried, including within the building. The report shall address specific requirements for utilities, including but not limited to soil corrosivity issues and protection of piping from corrosion-induced failure, groundwater, bedding and compaction requirements, and any additional requirements unique to the project site to ensure safe, stable, and durable system installations. The report shall also address need for underslab dewatering (subsoil) and foundation drainage, and any additional design recommendations that should be considered related to underground utilities. Refer to [Chapter 3: Civil Engineering & Site Development](#), [Chapter 4: Architectural Design](#) and [Chapter 5: Structural Design](#).

1. Excavation, backfill, and compaction (whether inside or outside the structure) shall be performed in accordance with requirements-specific on-site geotechnical conditions at the project so as to maintain proper support and grade for piping installations, and protect piping from superimposed loads (including construction traffic) groundwater, and corrosive conditions. Strict control of excavation, backfill, and compaction procedures shall be specified based on on-site conditions, loadings, and system materials.
2. The A/E shall specify compliance with on-site geotechnical requirements to address proper bedding and compaction for all underground plumbing and utilities in detail, and shall not leave determinations up to the contractor. A design professional shall direct specifications for such activities as well as required quality control.

3. Specific attention to corrosion control, dewatering, DRM piping slopes, and required bedding, backfill lifts, and compaction density, and protection from construction loads is mandatory and shall be addressed by the A/E and verified in construction.

4. A soil corrosivity evaluation shall be made to ensure compatibility with system materials, and shall consider resistivity, pH, oxidation-reduction potential, presence of sulfides, moisture content, presence and potential for stray current, known corrosivity, suspected corrosivity, and experience with existing installations in the project area. The geotech report shall include recommendations for further evaluation by corrosivity experts where such is deemed necessary.

***Rationale:** The A/E should coordinate requirements with piping system manufacturer recommendations to ensure that pipes are protected during excavation, backfill, and compacting of the bed especially when piping is buried within buildings. Reliance on contractors and codes alone is unacceptable.*

**K. Equipment Monitoring and Alarms:** Primary equipment supply systems and other items deemed critical or with potential impact on facility operations or safety shall be monitored and alarmed in accordance with the requirements of individual DRM chapters, with multiple levels of alarm response criticality (not less than a general fault and where applicable plant emergency fault) indication to the building automation system (BAS) or other NIH approved location. Alarms shall be located in areas of continuous occupancy, and shall not be located only in offices or similar space where alarm activation may be unnoticed. Alarms monitoring program areas of one user group shall be located such that an annunciation provides indication immediately to the responsible and affected party and personnel designated by NIH to receive and respond to such alarm condition. Monitoring capability to provide alert of fault conditions shall remain active, regardless of position of equipment components in manual or “hand mode”. Fault conditions and first detected faults shall remain in individual equipment PLC audit logs for not less than 120 days.

**L. Water Flood Alarms:** All mechanical rooms with wet equipment or water-storage tanks, whether plumbing or HVAC related, shall be provided with not less than two industrial-grade water flood alarms that shall alert to the BAS if water is detected at high points or normal floor level of the room. Additional alarm sensors shall be provided for large mechanical rooms such as to sufficiently monitor the room for flood issues. Cable-type systems may be used provided the cable is readily reusable after detection and does not require long “drying” periods for reuse, and provided the arrangement will not be damaged by floor traffic loads (including wheel loads associated with maintenance activities).

**M. Housekeeping Pads and Elevated Equipment:** Housekeeping pads shall be provided where deemed beneficial for major equipment. Where housekeeping pads are not provided, consider need to elevate equipment through use of corrosion-resistant bases. Cleanability shall be maintained for all sanitary and sensitive spaces.

**N. Critical Equipment Coordination:** Systems whose failure could result in significant loss of research, safety, or facility damage shall be coordinated with all other disciplines as necessary to address plausible single point failure. A risk assessment may be required.

**O. Fail-Safe Condition:** Upon unplanned loss of energy, systems and their associated control devices shall fail only to a normally safe condition, defined as a condition which prevents injury to persons or animals, damage to the facility, equipment, or infrastructure; and which minimizes any potential disruption to research.

**P. Automatic Restart:** Upon a power failure and subsequent restoration of power, all devices required for proper system operation shall automatically restart without requiring manual intervention, unless such automatic restoration would pose a safety hazard.

**Q. Manual Actuation:** Where the failure of an automated valve could result in loss of a critical service, such valves shall include a manual means for actuation.

**R. Equipment Redundancy:** Primary system equipment and devices requiring frequent maintenance or performing major control functions shall be provided with not less than  $N + 1$  redundancy (in parallel), appropriately sized and selected for efficient operation and durability. Unless otherwise noted, the  $N + 1$  arrangement shall

include both the equipment item, as well as the control system (programmable logic controller [PLC]) so as to avoid common, plausible failures and to minimize risks.

1. Any equipment item whose failure or routine maintenance would result in substantial loss of building operations or could impact research or scientific equipment shall be provided with required redundancy. All such systems and their respective monitoring devices shall be arranged with standby power supply. (Refer to [Chapter 10: Electrical Design](#)). Where transfer time from loss of normal power to standby power cannot be tolerated, consideration should be provided for the use of Uninterruptible Power Source (UPS).
2. Controls and equipment arrangements for primary infrastructure components shall be redundant to minimize potential for plausible single point failure.
3.  $N + 1$  arrangements shall, unless otherwise directed, be online and operational (such as automatic alternating/lead-lag), reduced load operation, or otherwise configured to ensure equal wear time, reliability, and availability of the redundant source.
4. Equipment which may operate in an automatic, but not PLC controlled mode may be utilized in lieu of redundant PLC's, where such use is determined suitable, compliant with the intent to preclude disruptions, and would not otherwise pose excessive risks. Arrangements may include constant pressure bypass control arrangements (e.g., arrangements that automatically revert upon PLC failure to sequence with automatic control valves such as pressure regulators as opposed to electronic controls). Where such arrangements are made, failure of PLC conditions shall still provide alert notification.
5. The A/E shall carefully consider the design capacity split and equipment quantities provided with regard to maintaining proper system operation in an energy and cost-efficient manner (e.g., providing three equipment items at 50% load may be preferable to two at 100%, or alternative capacity splits), especially if peak demand is low during much of the operating time; as well as the appropriate use of variable speed drives.



Appropriate devices may be staged to ensure efficient operation while maintaining appropriate capacity for essential building function.

6. The A/E shall assess the need for redundancy by reviewing if potential and plausible failure of the equipment or appurtenance could result in either substantial loss of the utility service to an entire building or multiple buildings, disrupt provision of any function that serves life support (human or animal), or potentially impact an entire program, building area (such as multiple floors) or disrupt research operations.
7. The A/E shall coordinate the alarm and critical requirements of each discipline and ensure that alarm functions and critical system functions are not subject to plausible single point failure associated with work of other supporting building systems (e.g., requirements for redundancy of equipment shall not be vulnerable to a single controller failure, alarm panels shall not be vulnerable to failure associated with a single fuse or circuit; systems shall not fail due to a series control arrangement, etc.).
8. N+1 redundancy is not required for dedicated office or other non-critical spaces as approved by ORF; however such systems shall still be arranged to minimize likely failures or extended disruption. Refer to individual sections for redundancy requirements for non-critical areas.

**Rationale:** N + 1 redundancy is required to ensure continuity of service and preclude failures which could significantly impact research and operations. The cost of N + 1 redundancy is typically far less than the potential risk of lost research or potential damage to infrastructure and cumulative costs that can occur under conditions of unplanned outage, and is therefore mandatory. The A/E must understand criticality of supporting infrastructure systems. In some cases, years of research, animal safety, and invaluable special research models and expensive scientific equipment can be at risk. Failures of one system can often translate to failure of other systems, including environmental controls. Tolerances for failure in the research environment and infrastructure supporting it are minimal.

*Redundancy of equipment cannot be left to failure of a single plausible failure, such as a PLC or other controller. Such failures could in many cases result in prolonged, unacceptable disruptions.*

**S. Controls Validation, Appurtenance Adjustment and Calibration:** All PLCs, controls, and software systems shall be validated for proper operation. All electrical control systems shall be appropriately listed by qualified manufacturers in accordance with UL or other approved listings. All control valves, sensors, and instruments shall be properly adjusted to appropriate design set-points under proper static and dynamic load conditions, and shall be properly calibrated.

**T. Temperature Extremes:** Piping and components shall not be placed where subject to freezing hazards or unacceptable heat gain that may plausibly cause damage, disrupt system operation, or compromise fluid quality. Temperature protection based solely on insulation and heat tracing is unacceptable.

### 1.15.3.1 Penetrations

**A. Sealed Penetrations:** Floor and wall penetrations shall be minimized and all penetrations shall be appropriately sealed to prevent leakage and maintain the fire rating of the structure for the life of the facility.

**B. Compatible Sealants:** Where sealants are used, they shall be verified compatible with the penetrating component. See [Appendix L: Sealant Table](#).

**Rationale:** Many sealants and elastomeric materials can be corrosive to various piping materials and eventually induce stress cracking or other corrosion.

**C. Pipe Sleeves:** Pipe sleeves shall be provided at all penetrations through floors; however they are not required for underground buried piping passing through the lowest building floor slab on-grade (unless necessary for corrosion resistance or to prevent moisture infiltration), and are not required for core-drilled construction through walls. Pipe sleeves shall extend a minimum 50 mm (2 in.) above the floor and shall include a built-in water stop and appropriate seal. Sleeves shall be cast into the original construction of the structure. Within

normally dry areas, a reduction of sleeve projection above the floor to not less than 25 mm (1 in.) above the finished floor is acceptable.

**D. Fire Ratings:** Penetration seals shall be selected to maintain the required fire/smoke rating of the penetrated item. Where the penetrated item is fire rated, fire stops shall be ASTM E-814/Underwriters Laboratories (UL) 1479 “W-Rated” to at least Class 1, in addition to required flame and thermal ratings. Additional requirements, such as UL 1479 “L-rated” maximum (CFM) leakage rates may be required; refer to [Chapter 6: Mechanical Design](#) and [Chapter 9: Fire Protection & Suppression](#). The selected fire stop material shall be chemically compatible with the penetrating material, and shall not induce corrosion, emit hazardous gases (including in burning conditions), and shall not be susceptible to premature failure.

**E. Existing Poured Wall and Floor Slabs:** Sleeves are generally not required for existing facilities with existing poured slabs where piping penetrations are added through the slab after the structure has been built. In such cases, holes shall be core-drilled and sealed with an appropriate UL 1479 Class 1 W-rated fire stop assembly, or in the case of non-rated penetrations expandable pressure-plate mechanical sealing devices may be used, or a mechanical sealing device arrangement may be provided. Approved engineered packed rubber-sleeve with sealant arrangements as well as manufactured molded compression joint seal systems that are UL Listed for the application and in accordance with DFM requirements may also be used. All fire stopping shall be in conformance with DFM requirements.

**F. Integrated Pipe Fittings:** Fire stop systems that are integrated with the piping are not acceptable. Exceptions may be made on application-specific basis if approved by the DFM and ORF and the system is constructed of materials in accordance with the *DRM*, listed to all referenced standards, and fully approved and compatible for the application.

**G. Equipment, Fixture, and Floor Penetrations:** All penetrations through floors and walls shall be sealed, including any required for plumbing fixtures. Penetrations for floor drains, floor sinks, and similar components must maintain structural strength and water-tight characteristics at the penetration. The use of box-out arrangements is not recommended and may

only be acceptable for non-containment, non-critical areas, where keyed into the slab, water-safed beyond all seams, and designed to maintain integrity permanently and under load conditions. Use of safing membranes, whether liquid or sheet type, are required for floor penetrations in wet areas. Safing membranes are also required for penetrations in or above aquatic areas, mechanical rooms, labs, ARF, clinical areas, food service spaces, and above any sensitive space. Refer to [Section 8.2 Plumbing Fixtures and Equipment](#), and [Section 8.4 Drainage Systems](#).

**H. Sanitation and Pest Control:** Penetrations through finished materials (non-rated) shall be sealed to facilitate cleanability and to maintain sanitation and pest control. See [Section 1.12 Integrated Pest Management](#).

---

## 1.15.4 Supplemental Technical Requirements for Animal Research Facilities

ARFs require architectural and engineering enhancements beyond items previously addressed.

**A. Program Requirements:** The design of engineering systems for ARFs necessitates close coordination with program staff to determine the exact program requirements and to ensure arrangements will not compromise animal health or introduce unintended variables upon animals and research. Due to the nature of the research, ARFs often require the facility space to be occupied at all times of the day/night and throughout everyday of the year; hence shutdowns due to emergencies, maintenance, or other factors must be avoided at all costs.

**B. Humane Care:** Systems shall be arranged to comply with PHS Policy (Public Health Service Policy for Humane Care and Use of Laboratory Animals), American Veterinary Medical Association (AVMA), and Institute for Laboratory Animal Research (ILAR), and shall not impose stress, harm, pain, or safety risks to animals, including as the result of failures. Issues of concern or potential safety consequence shall be approved by the NIH, including the ORF, DOHS, and the program veterinarian or appropriate Animal Program Director.

**C. Controlled and Limited Access:** Systems shall be designed as much as possible to preclude disturbances to animals during normal operation and maintenance. Systems shall be arranged to promote only controlled and limited access to the animal care areas, and to the extent possible to ensure that routine maintenance activities may be performed without the need to actually enter the ARF, especially the animal holding rooms and barrier facilities.

***Rationale:** In addition to security and cross-contamination control issues, animals can be especially sensitive to environmental elements, including vibration, noise, water, air quality, and disruptions to routine. Such disruptions can have negative effects on animals and research. System designs necessitating maintenance workers to enter animal rooms can pose further safety issues, cross-contamination, sanitation challenges, and can be highly disruptive to research programs.*

**D. System Arrangement and Penetrations:** System designs shall minimize potential for accumulating dirt and pest harborage. All pipe penetrations, exposed equipment, mounting brackets and supports shall be caulked with approved sealants. Penetrations should be minimized. Exposed piping inside ARFs shall be minimized, and shall stand off from walls and ceilings 25 mm (1 in.) with a corrosion-resistant sanitary pipe clamp arrangement to permit cleaning, constructed to minimize concealed fouling spaces and sharp edges. Refer to [Appendix L: Sealant Table](#).

**E. Out of Reach:** It is essential that utilities and devices be mounted out of reach of animals. This is especially true for non-human primates (NHPs). Where components and utilities must be located within animal spaces, selection of materials, insulation and mounting shall be sufficient to prevent damage or injury, including in the event of escaped animals, or as due to ingestion.

**F. Exposed Piping:** Where utilities must be exposed (surface mounted) within the vivarium, utilities shall be durable, protected from impact, and installed to maintain sanitation and preclude corrosion. The use of stainless steel material or properly bonded, cleanable, and chemically resistant protective coatings shall be provided where utilities must be exposed and are susceptible to corrosion, and shall stand-off from finished

surfaces. Exposed piping shall be chemically compatible, non-porous, smooth, with sanitary surfaces, and shall utilize sanitary type piping clamps and supports. Hangers/clamps and all associated attachments shall be corrosion resistant (typically stainless steel with plastic grommets), free of sharps, and where applied in ABSL-3 areas exposed piping shall be in conformance with ASME BPE-2002 and properly sealed with an approved sealant. Selected exposed materials shall be verified compatible with cleaning agents through consultation with the program use group.

**G. Large Animal Spaces:** Large animal spaces (larger than NHP) may be subject to additional project-specific requirements. The A/E shall consult the program requirements and with the ORF as required to determine individual requirements.

**H. Barrier and Quarantine Facilities:** Special care is needed in the design of barrier facilities (such as specific-pathogen free, gnotobiotic, and quarantine areas) to minimize potential for cross-contamination and to maintain the sanitary environment. Boundaries of barrier facility areas shall be designed according to program requirements and shall be clearly designated on drawings. Refer to individual *DRM* Chapters for specific guidance.

**I. Pipe Routing:** Avoid routing piping over animal holding rooms, surgery, and necropsy spaces wherever possible, as well as buried in the slab below such rooms, except for piping branches serving these spaces. Double containment is not required for non-hazardous piping over animal holding rooms and necropsy.

---

## 1.15.5 Supplemental Technical Requirements for High Containment Facilities

High containment facilities require architectural and engineering enhancements beyond items previously addressed. The following requirements apply to BSL-3, facilities operating at maximum containment (BSL-4) shall be subject to project-specific requirements.

**A. Program Requirements:** The design of engineering systems for high containment facilities necessitates close coordination with program staff and requirements of a

proper risk assessment to determine the exact program requirements and to ensure arrangements will not compromise operations, research or pose safety hazards.

**B. Maintenance Access:** Systems shall be designed as much as possible to preclude disturbances to the research from maintenance. Systems shall be arranged to promote only controlled and limited access to the high containment areas, and to the extent possible to ensure that routine maintenance activities may be performed without the need to actually enter the containment barrier.

**C. Access Control:** High containment access control shall use fail-secure methodology. This allows for a fire alarm to not automatically override the facility perimeter security locking system. For specific physical security requirements contact PO to coordinate with DPSM; see [Section 1.13 Security Requirements and Procedures](#).

**D. Material Selection & Edges:** Materials and finishes should be selected to be non-porous, cleanable, free of sharps hazards, and resistant to selected decontamination method and cleaning agents. All items shall be sealed to prevent leakage of fumigation gases. Particular attention should be applied to common hardware items (e.g., bolts and screws) to ensure non-hazardous conditions. Equipment, furnishings, infrastructure or objects within the containment barrier should have smooth and radiused edges and corners to avoid the tearing or catching of PPE.

**E. Penetrations, Sealants & Envelope:** The perimeter walls, floor, ceiling, doors, windows and other elements that surround and contain the lab must be constructed, finished and sealed sufficiently to prevent or ensure the control of leakage and infiltration. All penetrations into and through partitions, floors, and ceilings shall be sealed to enhance sanitation, accommodate gas and vapor decontamination, and resist air infiltration. All penetrations shall be inspected to meet the room-tightness criteria. Penetrations shall be sealed with an approved non-shrink corrosion resistant, cleanable, gas and water-tight, permanent sealant. Spray foam is not acceptable. See [Appendix L](#) for the Sealant Table. Penetrations through the containment barrier shall be gas-tight, non-porous, smooth, cleanable, unconcealed and visible for routine inspection, cleaning, and maintenance. Flexible elements (e.g., hoses, wires, etc.) shall not penetrate the containment barrier without being within an appropriately sealed, rigid pipe or conduit. Penetrating components shall be sufficiently rigid in

construction or adequately braced to maintain the long term integrity of the penetration.

**F. Insulation Component Penetrations:** Insulation shall terminate at the back face of the penetrated material, prior to the containment barrier unless required for condensation control, safety or similar critical need. Exposed insulation may be provided within containment and may be continuous through the penetration only where rigid, sealed, and impervious, water- and chemically-resistant insulation jacket encasement systems are utilized. Exposed seams and sharp edges are prohibited.

*Rationale: Conventional piping system insulation and jackets are not readily cleanable, free of fouling areas, or sufficiently rigid. Continuous insulation through barrier penetrations requires use of rigid insulation systems to maintain a durable seal.*

**G. Escutcheon and Pipe/Conduit Penetration Trim:** Escutcheons, including but not limited to split-ring and cupped type, shall not be utilized for penetration seals within containment. Flat stainless steel washer or corrosion-resistant durable trim plate bedded in sealant and properly caulked to the penetrated material and piping may be used if the penetration seal is durable and visible for routine inspection.

*Rationale: Escutcheons prevent routine visual inspection of penetrations, may not be sufficiently durable to remain gas-tight, and can harbor pests.*

**H. Penetration Documentation and Mock-up:** Penetrations into the containment barrier of a BSL-3 facility shall be detailed in the construction documents, and shall require mock-ups to be constructed and approved prior to installation.

*Rationale: Provision of mock-up allows for confirmation of acceptable construction and understanding of requirements prior to undergoing expensive construction.*

**I. Waste:** Waste must be sterilized as it exits the BSL-3 laboratory. Most waste is autoclaved. Considerations about placement and throughput of autoclaves need to be extensively evaluated.



**J. Communication & Operational Issues:** Consideration should be given to operational issues such as how the staff will function and interact both inside and outside the containment barrier; items such as communication systems, data collection, PPE gowning (donning/doffing) and storage need to be addressed with program staff.

**K. Facility Acceptance:** DOHS and ORF inspections/approvals are required for all high containment facilities.

**L. Exposed Piping:** Exposed piping shall be chemically compatible, non-porous, smooth, with sanitary surfaces, and shall utilize sanitary type piping clamps and supports. Hangers/clamps and all associated attachments shall be corrosion resistant (typically stainless steel with plastic grommets), free of sharps, and where applied in ABSL-3 areas exposed piping shall be in conformance with ASME BPE-2002 and properly sealed with an approved sealant.

**M. Service Access Panels:** Access panels and openings through containment barrier walls or ceilings shall be avoided. The use of full stainless steel access cabinets with closed backs and sides, gaskets, and stainless steel pipe inlets weld sealed to the box can be utilized to provide a sealed, recessed box arrangement. Access doors are not acceptable in ABSL-3 areas or insectaries.

---

## 1.15.6 Risk Assessment, Systems Failure & Disaster Mitigation

At the pre-project planning stage an A/E should investigate all facets of the research and how it dictates the program, equipment, and necessary infrastructure. In order to fully evaluate the project requirements, risk assessments should be conducted by the appropriate party(s) (as applicable to each issue) to identify and address hazards and their mitigating actions, and to ensure sufficient consideration of elements as may affect achieving an optimal design. A properly conducted risk assessment should measure the criticality of each architectural and engineering system and associated components, its potential for failure, and the consequences involved during a failure scenario. Once the risk assessment has been conducted, appropriate corrective action plans should be provided to

mitigate hazards. The degree of formality of risk assessments and their subsequent corrective action plans may vary by application, however the provision of formal risk assessment and corrective action plans is required for hazardous systems and high containment applications. Each risk assessment should be performed by a team of individuals, inclusive of responsible parties and subject matter specialist. Risk assessments must be reviewed and approved by the NIH, and may additionally include Principal Investigator(s), representatives of DOHS, DRS, NIH, ORF and others. Guidance for properly conducting a risk assessment is available from standards organizations including International Organization for Standardization (ISO), and the AS/NZS 4360 Australia/New Zealand Standard for Risk Management.

Disaster planning is of the utmost importance in research facilities as the unplanned loss of critical infrastructure and consequences of system failures can lead to the potential loss of research, extensive disruption, and risks to safety. The A/E should work with research personnel to determine what courses of action should be taken if failure of one or more systems should occur, and to evaluate potential risks and their preventative and mitigating actions. Items to consider, though not all inclusive are: how to handle supply deliveries during severe weather or natural disasters (fuel gas, caging supplies, animal drinking water, maintaining safe ARF environmental control, etc.); how to appropriately size reserves for delayed deliveries; how to setup monitoring and alarm systems to notify personnel; how to establish appropriate redundancy; how to access, maintain, and repair downed equipment in a safe, secure manner with minimal disturbance to research.

**A. System Design Considerations:** Systems shall be designed and materials selected to minimize potential for loss of service; to avoid or minimize impact on research and facility operations in the event of disaster or malfunction; and to avoid design errors that may cause or significantly extend damage or failure. Throughout the planning and design stages, the A/E shall evaluate each system design to assess potential steps that should be taken to alleviate future damage, service disruptions, and promote rapid restoration of temporary and normal services in the event of a failure.

**B. Site and Project-Specific Risks:** The A/E shall consider the site and project-specific risks associated

with each system. Appropriate steps shall be taken in design to ensure maintenance of critical services and control of risks.

**C. Qualified Personnel:** A comprehensive risk assessment by qualified, personnel is required for any toxic or hazardous service, as well as for any system or process whose failure could result in a significant loss of research.

**D. Disaster Response Plan Coordination:** Provisions to address disaster response in regard to engineering systems shall be coordinated with facility disaster response plans.

**E. Requirements:** Examples of requirements that shall be considered by the A/E during project design and include but are not limited to the following:

1. Segregate major/critical redundant infrastructure systems such that a catastrophic failure, fire, utility disruption etc. does not negate planned redundancy.
2. Carefully evaluate arrangements and locations of components for continuity, service quality, and safety, including their failure sequences and potential for cascading failure.
3. Coordinate the planning of support and monitoring infrastructure to preclude single point and control cascading failures.
4. Conduct an appropriate assessment of the risk and consequences of plausible single point failures, including potential for simultaneous or cascading failures and address required engineering provisions commensurate with the risk.
5. Follow good engineering practice in the design and analysis of all systems as well as review of installations to ensure safe and proper operation; minimize risk of failures; ensure where failures occur they are controlled in a safe manner and damage and disruption are minimized to the extent possible.
6. Conduct a site-specific risk assessment appropriate to the application and hazard, including but not limited to natural hazards; meet with the program administrators to discuss, plan, and integrate design and response plans.
7. Properly seal each penetration regardless of size, provision of adequate drainage, and installation of raised sleeves to preclude water migration from floor to floor in the event of leakage.
8. Locate utilities and source equipment in “safe” areas where failure risks and consequences can be minimized. Avoid piping above critical and sensitive areas (such as electrical rooms, data rooms, data and records storage, imaging equipment, cleanrooms, etc.).
9. Avoid locating critical controls or sensitive elements in proximity to other items or equipment that may impart damage or safety hazards.
10. Locate all emergency devices, maintenance devices, and critical components to be readily accessible (including under emergency conditions); verify proper operation and commissioning; and ensure appropriate O&M data has been provided.
11. Locate equipment and appurtenances in uncealed or readily accessible locations as appropriate for the device and to facilitate routine inspection.
12. Locate major infrastructure equipment where not susceptible to flooding, freezing, or other hazards and where damage, rupture, or leakage of piping or equipment would not cause additional negative consequences.
13. Review installation of thermal and vibration accommodation provisions, anchorage and bracing, restraints, flexible connectors, and similar devices designed to accommodate movement; ensure such devices are provided at all required locations.
14. Ensure adequate drainage for utility tunnels to accommodate normal operations, as well as consideration of impacts from a pipe break or external water ingress (such as from high groundwater).
15. Ensure adequate separation between sensitive electrical infrastructure and potential sources of steam and water exposure especially as may occur under plausible failure conditions.
16. Ensure adequate quality control for materials, construction, qualified installers, and test and validation processes.



17. Provide sufficient utility isolation and provisions to permit back-feeding/backfeed-insertion points to serve critical application and ARF in the event of service loss.
18. Ensure critical equipment is appropriately monitored and alarmed.
19. Where wet equipment rooms must be located directly above sensitive areas, provide automatic flood-monitoring systems for equipment and adequate floor drainage with safing membrane for floor and drain penetrations. All mechanical rooms with wet equipment shall be provided with room flood monitoring to the BAS.
20. Isolate the location of primary from backup source equipment and distribution, coordinate independent utilities where appropriate, and ensure provisions to minimize risk of a single event resulting in multiple failures.
21. Provide adequate quantity, location, and separation of reserve supplies.
22. Provide hardwire interlocks for critical safety components, redundancy where appropriate, and proper fail-safe status for all controls.
23. Consider the potential for and consequences of mechanical damage, water damage, chemical exposure, electrical failures, and environmental consequences for all installations.
24. Consider the most plausible failure conditions, appropriate response to address failures, and risks of operating errors and safely design systems and communicate hazards to contain risks.
25. Communicate system design features and risks to the program administrators such that appropriate mitigating actions may be considered and documented.

***Rationale:** Failures in systems can cause substantial impact to facility operations and loss of research. Many catastrophic utility failures can be prevented or controlled by provision of redundant equipment and appropriate standby power supplies, commissioning activities, automated monitoring and response plans. These specific additional precautions should be addressed in the architectural and engineering design of systems for research and vivaria along with an evaluation of additional risks in conjunction with the program to ensure appropriate plans are maintained and to mitigate risks. The rapid restoration of services and minimization of damage is critical in any emergency and is best accommodated through careful planning and installation quality control. The requirements of this section are not all-inclusive, and are not intended to address all provisions necessary for safety or to prevent and mitigate failures. System designers/engineers must appropriately consider each system and the inherent risks and features to ensure proper design, operation, and failure response on a project specific basis.*

### 1.15.7 Failure Corrections and Root Cause Analysis

**A. Analysis/Action:** For any case where a failure or repetitive failures has occurred, the need for root cause analysis and mitigating action shall be considered and the recurrence of repetitive failures shall be reported to ORF. The A/E shall notify the PO if it is believed such action is necessary but out of scope.

**B. Failure Causes:** The A/E shall be careful to not just address the immediate repair of failures, but also to consider potential underlying causes and any safety impact.

***Rationale:** When designing a repair or renovation in response to a failure(s), it is critical that the cause of the failure (not just the symptoms) be addressed to minimize potential for future damage, failures, or safety concerns.*

---

## **1.15.8 Specification of Contractor Qualifications**

**A. Qualified Installers:** Specifications by the A/E shall require use of appropriately qualified, licensed personnel, properly trained and experienced to perform the work required, and in compliance with federal regulations.

# Chapter 2

---

## Planning and Programming

# Section 2.1

## Research Laboratory Predesign

---

### Contents

#### 2.1.0 Introduction

#### 2.1.1 The Master Plan

#### 2.1.2 Project Program

##### 2.1.2.1 Project Parameters

##### 2.1.2.2 Data Collection

##### 2.1.2.3 Documentation

#### 2.1.3 Laboratory Planning

##### 2.1.3.1 Staffing

##### 2.1.3.2 Space Requirements

##### 2.1.3.3 Functional Relationships

##### 2.1.3.4 Circulation

##### 2.1.3.5 Workplace Enhancement

##### 2.1.3.6 Flexibility

##### 2.1.3.7 Occupational Health and Safety

##### 2.1.3.8 Laboratory Types

#### 2.1.4 Predesign Deliverables

## 2.1.0 Introduction

The purpose of the predesign phase is to identify and document factors that will impact the project to ensure that the design will yield an efficient workplace that is responsive to scientific objectives, and be ergonomic, safe, and well suited for investigative staff. The intent of this phase is to gather information and to identify issues to delineate a wide range of parameters including type(s) of research, project objectives, projected staffing, space requirements, existing conditions, design criteria, site planning issues, schedule, budget, energy and life cycle costs, and considerations for future growth. Development of a comprehensive project program document in the early stages of a project facilitates the design process by providing a reference against which subsequent decisions and development can be tested.

The NIH requires an integrated planning and design process that seeks the active and continuing participation of all stakeholders who are affected by the project from planning through activation and operation. Stakeholders must be familiar with the requirements of the particular project, as well as the goals of NIH. At a minimum, the stakeholders who must actively participate in the project's plan and program phase include:

**A. Executive Oversight:** Scientific director and/or executive officer, program facility manager, project officer (PO), including representatives of the Institute or Center (IC) that will occupy the project

**B. Users:** Principal investigators (PIs) and their delegates, technical staff, administrative staff, etc. who are involved in the use and operation of the laboratory

**C. Architect/Engineers:** Architect, laboratory planner, mechanical/plumbing engineer, fire protection engineer, electrical engineer, civil/structural engineer, and other specialists required by the unique aspect of the project (i.e., vibration analyst, acoustical engineer)

**D. Safety:** Environmental, health, industrial hygienist, radiation, fire protection and other safety professionals

**E. Commissioning Agent (CA)**

**F.** Additional stakeholders must be provided with the opportunity to participate in the planning and programming phase and review document submittals:

1. Division of Technical Resources (DTR)
2. Division of Facilities Planning (DFP)
3. Division of Environmental Protection (DEP)
4. Division of Occupational Health and Safety (DOHS)
5. Division of Radiation Safety (DRS)
6. Division of the Fire Marshal (DFM)
7. Division of Facilities Stewardship (DFS)
8. Utilities Engineering Branch (UEB)
9. Division of Facilities Operations and Maintenance (DFOM)
10. Division of Physical Security Management (DPSM)
11. Center for Information Technology (CIT)
12. Architectural Design Review Board (ADRB)
13. Office of Hospital Physical Environment (OHPE)
14. Clinical Center Office of Facility Management (CCOFM)
15. Transportation Management Branch (TMB)
16. Additional NIH and municipal and jurisdictional entities as determined by the PO

## 2.1.1 The Master Plan

All projects should conform to the requirements of the applicable NIH campus master plan. Projects developed at locations outside of NIH campuses shall conform to the planning and zoning requirements of the local jurisdiction. For additional information, contact DFP and reference <http://orf.od.nih.gov/PlanningSpaceManagement/NIHMasterPlanning>.

Master plans for NIH sites serve as planning tools for the strategic growth and development of NIH campuses, including sustainable environmental design concepts. NIH master plans apply to new buildings and

renovations; they provide a framework for development that achieves growth objectives while protecting and enhancing the environmental qualities of NIH sites and surrounding communities. In NIH master plans, key planning elements, major relationships and patterns, and standards are defined, including the issues of building size and mass, site characteristics, open space definition, and site access and circulation.

***Rationale:** Adherence to master plans ensures that planning strategies are recognized and followed.*

## 2.1.2 Project Program

The project program includes a definition of the program, including organizational and design concepts, facts, goals, and space needs. Organizational and design concepts include functional relationships, adjacency requirements and other form-giving parameters. Facts include site constraints, regulatory and code requirements. Goals include customer and user expectations. Needs include physical requirements, utility distribution, and other similar project requirements.

A laboratory project program requires an understanding of the general processes and specialized functions to be conducted within a research lab. Laboratory planners must determine the specialized needs of the specific discipline. Different fields of research have varying demands for bench configuration, containment devices, lab utilities, support space, equipment density, safety, and other criteria.

### 2.1.2.1 Project Parameters

Program development parameters that frame the project scope shall be identified so that they will inform decisions made throughout the design phase. Initial project parameters are generally defined in the Statement of Work (SOW) and Program of Requirements (POR). Program development is the process of expanding this information to a greater level of detail.

**A. Boundaries:** The project boundaries shall be defined, including site constraints, service utility areas, dedicated corridors and adjacent occupied out-of-scope areas that may be impacted by the project. Available

as-built information including drawings, specifications, and testing reports shall be collected and field verified to establish an accurate project baseline. Inaccessible areas that require inspection shall be identified for further investigation during early design phases. Structural capacities and clearances shall be verified as they may limit program opportunities and flexibility. For projects on new sites, geotechnical, property surveys, topographical information, utility, forestation, wetland, and all other pertinent information shall be obtained.

**B. Utilities:** The size, location, and condition of existing utilities serving the project site shall be verified. The adequacy of capacities relative to project requirements must be determined during programming to establish required upgrades and availability for future growth. Factors to facilitate decisions on these issues shall be clearly outlined during this phase.

**C. Current Program:** If the program under development is intended to serve an existing user group, valuable information can be obtained by touring the group's existing laboratories to observe their processes and support activities, equipment to be relocated, facility deficiencies to be rectified, and the general cultural dynamics and relationships among user groups.

**D. Safety:** The safety of building occupants shall be a primary factor in decision making. Safety shall be considered in all of its aspects, including biological and hazardous materials safety, physical safety and security, and occupational safety.

**E. Hazardous Materials:** Program requirements for use and storage of hazardous materials, including chemicals, radiologic materials, and biologic agents, may be determined by code and regulatory requirements. The project team shall identify the authority having jurisdiction for establishing allowable quantities of hazardous materials, and shall document requirements for the project based on proposed project location, areas within the project, and applicable codes.

**F. Building Integrity Guidelines:** Several NIH campus buildings in Bethesda, Maryland, have integrity guidelines that provide criteria and design restrictions for future alterations. All renovations within buildings with Integrity Guidelines shall adhere to the requirements set forth in the guidelines. Confirm applicability of Guidelines with the PO.



**G. Sustainability:** Identify project sustainability goals and appropriate level of third-party certification. At a minimum, adhere to the HHS Sustainable Buildings Plan with the intent to be sustainably responsible over the life of the project.

**H. Budget:** Programming-phase information such as square footage, infrastructure suitability, and laboratory type have inherent cost implications that shall be considered and reconciled with the project budget prior to commencing with the design phase. Budgets should include appropriate contingencies relevant to project phase and complexity.

**I. Schedule and Phasing:** A project schedule shall be developed that includes programming, design, construction, commissioning, and occupancy milestones. The schedule shall include adequate time for NIH and other regulatory reviews and approvals. The schedule may include phasing requirements if required to limit occupant disruption or meet budget parameters.

*Rationale: Project parameters form a basis upon which decisions can be made throughout the design process.*

### 2.1.2.2 Data Collection

Data collection is an assessment of project needs of the component user groups, including primary scientific disciplines, relationship among user groups, biosafety level(s), existing and projected staffing types and quantities, space types and quantities, support spaces and core facilities used, types and quantities of scientific equipment and associated requirements, operating procedures, and inventory of hazardous materials used or stored on-site. Data may be collected in the following ways:

**A. Executive Meeting:** A meeting with executive level staff to identify stakeholders and to establish lines of communication, project protocols, information sources. Other items to identify include project objectives, budget, schedule, and constraints.

**B. Program Questionnaire:** Questionnaires issued to each component user group including templates for equipment schedules and chemical inventory. See [Exhibit 2.1 Research Facilities Program Questionnaire](#).

**C. User Interviews:** Interviews to ensure complete data gathering, and when needed, assist users in completing questionnaires and schedules

**D. Site Survey:** Tours of existing laboratories, where possible, to observe existing conditions, workflow, equipment and to verify as-built documentation

**E. Technical Interviews:** Interviews conducted as needed with technical personnel including building maintenance and operations, safety, security, information technology, and waste management, as well as the building manager, the fire marshal, and others as needed.

**F. Hazardous Materials Inventory:** An inventory of chemicals, and radiological and biological materials used and/or stored must be provided by the stakeholders and reviewed by Division of Occupational Health and Safety (DOHS) personnel. Data must be checked against applicable codes to verify that the proposed hazardous material use is compliant with allowable limits for the proposed site.

**G. Room Data Sheets:** Room Data Sheets shall be developed for common room types. Due to the specific nature of research spaces, the information on these data sheets should be carefully reviewed with room users and documented accordingly. Room data sheets shall include a section for the stakeholders' approval (signature). Typical Room Data sheets are included in [Appendix F](#).

**H. Equipment Data:** Equipment data shall be collected and documented. Generic data may be used for common items such as refrigerators and freezers when these items are not yet procured. Specific detailed equipment data and technical parameters (cut-sheets) should be obtained from users whenever possible. Manufacturer data sheets shall be obtained for specialized scientific equipment to ensure that variability in dimensions, service clearances, utility demands, heat output, weight, and environmental requirements are available for the design phase. Environmental sensitivity, shielding requirements, magnetic field and radiation emissions and all other pertinent information shall be documented. An Equipment Schedule Template is provided in [Appendix G](#).

**I. Code and Regulatory Requirements:** Provide a complete listing of applicable code and regulatory requirements.

**J. Sustainability/Life Cycle Requirements:** Provide a specific list of Sustainability goals and objectives, tailored to the size and scope of the project, and meeting NIH, HHS and other Federal regulations and requirements. Provide a method of monitoring the progress toward these goals, and confirming achievement upon completion.

**K. Operating Procedures:** An understanding of the laboratory's standard operating procedures (SOPs) and daily flow of activities facilitates the successful design of an efficient, ergonomic laboratory.

**L. Special Studies:** For large or specialized projects, additional studies may be required to determine requirements for vertical transportation, data/communications, loading dock capacity and logistics, waste disposal, security, transportation planning, laboratory exhaust dispersion, vibration, acoustics, shielding, weight and other factors that impact design. Early in the project's programming process a stakeholder meeting shall be convened to determine the scope of additional studies required.

**M. Benchmarking:** Design teams are encouraged to share data with the stakeholder group on similar pertinent projects to lend perspective to the programming process with respect to a diversity of approaches. Data on construction costs, instrumentation, program composition, innovative design approaches, and other industry trends that may help inform the planning and programming process should be shared.

*Rationale: Data collection ensures that the processes, needs and requirements of the lab have been understood, documented and recorded.*

### 2.1.2.3 Documentation

Plan and program data is captured and recorded in a variety of ways, including completed program questionnaires, narratives, relational diagrams, proximity matrix, space data sheets, equipment schedule, chemical use and storage forms, and interview minutes. This information shall be included in the Program of Requirements (POR). The POR must be available to the entire project team for reference as the project progresses. The POR shall be included in the documents issued to the NIH for review.

In later design phases, additional supporting information shall be added to document decisions made and information obtained. Data shall be updated at each design phase as part of the Basis of Design (BOD), and shall be included in the documentation submitted for NIH reviews and approvals, and shall be used to evaluate the success of the project in meeting programming objectives.

## 2.1.3 Laboratory Planning

The laboratory planning process utilizes program data to develop well organized, coordinated spatial concepts that successfully address user goals, functional needs, project parameters, and design requirements. Planning shall address issues such as adequacy of space for its intended use, occupant comfort, and ergonomics (both laboratory and support spaces) as required to create a functional facility. Adequate space shall be provided to accommodate laboratory components including chemical fume hoods and/or biological safety cabinets (BSCs), laboratory benches, equipment, storage, and desk space. The space shall be organized to provide safe, functional, and efficient working areas with workflows and location of special equipment addressed.

### 2.1.3.1 Staffing

The number of research staff in any laboratory can vary greatly, and include personnel at a number of professional levels. At the NIH, research components are generally divided into sections and/or units. Each section or unit is supervised by a lab chief and managed through that section or unit's office of the chief (OOTC).

The actual occupancy of each laboratory must be determined, and must include regular staff, visiting scientists, students, and other potential occupants.

### 2.1.3.2 Space Requirements

Each laboratory project has unique program characteristics. There may be general characteristics that can be used as the basis for developing preliminary space requirements. [Figure 2.1.3.2](#) shows the general rules of thumb to be used for preliminary planning purposes when a detailed laboratory program has not

been developed. The data assumes equal allocations of laboratory and laboratory support space. These rules of thumb apply to general biology laboratories, and do not take into account special function labs or animal facilities. Areas for these specialized functions must be included in the overall program formulation.

**Figure 2.1.3.2 Gross and net area calculations – Typical proportion of laboratory functions**

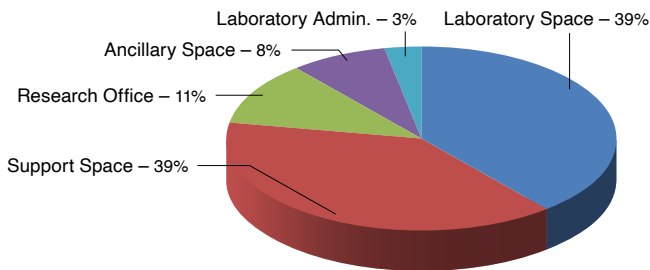

### 2.1.3.3 Functional Relationships

The organization of a laboratory facility will be determined by the structure and operation of the program as well as practical, safety, and ergonomic factors. It is also important to explore new ideas that may not necessarily replicate the existing organizational structure, including alternative organizational paradigms that may be cross disciplinary or focus oriented to enhance collaboration and resource sharing.

Laboratory facilities are typically organized into two basic zones: a personnel zone and a laboratory zone.

They may be supported by a core zone, consisting of centralized, specialized functions such as animal research facilities (ARFs), imaging suites, and freezer farms. Staff and visitors enter through the personnel zone, which consists of an entry/waiting area, administrative offices, conference rooms, personnel support facilities, and other areas that require a nominal level of security. The personnel zone connects to the laboratory

**Figure 2.1.3.3 Relational diagram. Typical functional relationships and adjacencies**  
ARF = Animal research facility

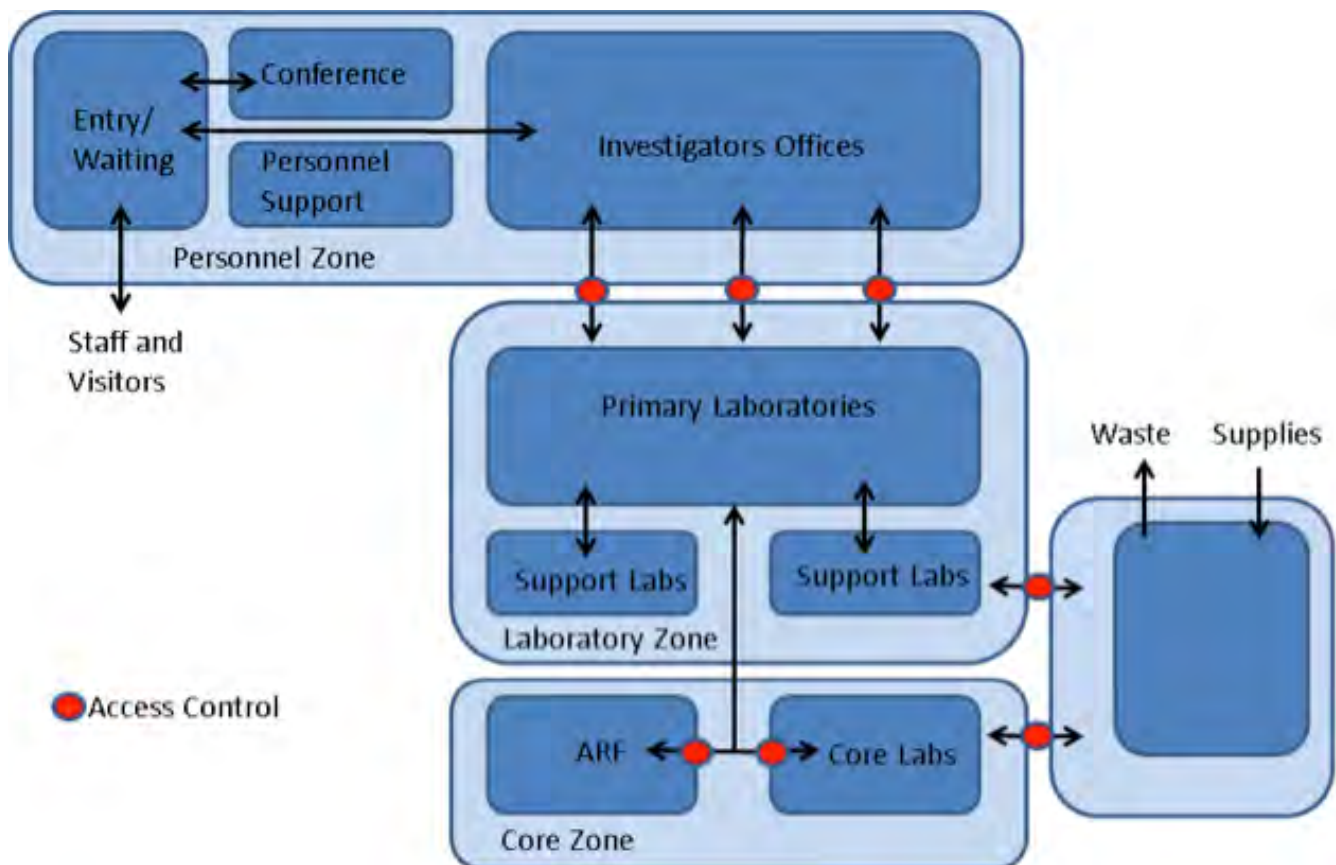

zone via a controlled access point. The laboratory zone includes primary and support laboratories, and may include write-up areas. In some cases, investigator offices may adjoin laboratory space; however, without a physical barrier between the two, limitations will be imposed on visitor access, consumption of food and drink, and types of acceptable finishes. A logistics zone that includes shared support such as loading docks, storage, gas cylinder manifold areas, utility closets, etc., will also connect via a controlled access point to the laboratory zone. Physical separation of laboratory and office areas also creates opportunities for a more energy-efficient, zoned heating, ventilation, and air conditioning (HVAC) design.

Figure 2.1.3.3 identifies adjacencies and relationships among primary program components.

The organizational structure of component lab groups and other program elements shall be identified and recorded in a matrix that illustrates proximity preferences among each program element. Relationships that should be defined include:

1. Organizational structure and working relationships of component occupant groups
2. Relationships among component divisional groups
3. Relationship of investigator offices to labs
4. Relationship of primary labs to support labs
5. Relationship of labs to core and special support labs
6. Unique program elements requiring special consideration or utility services

### 2.1.3.4 Circulation

The patterns of circulation for staff, visitors, materials, research animals and waste shall consider security, separation of visitors and staff, isolation of circulation related to research animal facilities, material handling and distribution, and safety and biohazards. Waste removal shall include consideration for general waste, recycling, and hazardous material marshaling. Another aspect of circulation design is the opportunity to enliven a facility and provide opportunities for staff meeting and interaction.

All labs contain potential hazards and require access control. Laboratories with especially hazardous materials, equipment or procedures (e.g., laser labs, radioisotope labs, containment labs, and other labs identified by users or DOHS) shall be physically separated from other labs and provided with control devices to limit access to authorized personnel. Warning signs indicating the hazard may be required.

### 2.1.3.5 Workplace Enhancement

The laboratory environment supports personnel who spend large portions of their time within a highly technical workplace. Laboratories design shall promote physical and psychological well being and shall achieve high aesthetic, ergonomic and safety standards. The following guidelines represent typical elements found in laboratories. During the predesign phase the planner or design team will determine the project-specific space needs.

**A. Functional Zoning:** Laboratories must be separated from administrative and personnel support areas and secured to prevent access by unauthorized personnel. Within the laboratory, areas of higher hazard should be isolated and secured and located in a manner that maximizes safe egress from the laboratory. Laboratory equipment and procedures that create excessive noise, heat, vibration, or require special environmental conditions should also be separated from regularly occupied areas.

**B. Personnel Support:** Personnel support areas required for the safe conduct of laboratory work shall be provided at appropriate locations. These typically include break areas where lab personnel can eat, drink, and interact outside of the laboratory environment, lockers and cabinets for storing coats and personal items, and areas for donning personal protective equipment (PPE) prior to entering labs. Consideration should be given to the placement of lab personnel workstations outside of the lab bench area. Workstations can be visually connected but physically separated from the lab for increased safety.

**C. Natural Lighting:** Natural lighting should be provided to the greatest extent possible, in all areas normally occupied, especially areas where researchers spend the majority of their time including primary laboratory areas, write-up workstations, administrative offices, and break areas. Internal windows and interior glazed walls



are encouraged to provide borrowed light and exterior views, and to enhance visibility of laboratory personnel for safety and security. Natural lighting should not be provided in support labs and other areas with low occupancy, or where scientific considerations require dark or controlled-light conditions. The extent of exterior windows in laboratory areas must be moderated to the extent necessary for thermal stability and light control, including glare on BSC sashes and other equipment.

**D. Staff Interaction:** Planning concepts shall provide opportunities for communication and informal interaction among building occupants. Common-use interaction spaces including lockers, vending areas, copy areas, break areas, lobbies, conference rooms, etc., shall be strategically located to enhance contact and collaboration among staff. Underutilized and unassigned space such as corridor alcoves, open stairwells, and elevator lobbies can also provide opportunities for interaction, and may be enhanced with informal seating, communication boards, or natural lighting. Other potential interactive spaces include exhibit areas and public spaces. Careful consideration of the informal interaction dynamics shall be discussed and documented as part of the predesign phase.

*Rationale: Workplace enhancements are necessary building elements that promote efficiency, collaboration, comfort and convenience of laboratory staff.*

### 2.1.3.6 Flexibility

A designed-in degree of flexibility and adaptability will allow a laboratory to meet evolving research needs and functional changes over the life of the facility with minimal disruption to ongoing programs as well as to accommodate changing technologies in scientific procedures. The following planning concepts can provide flexibility in the new facility.

**A. Generic Design:** A generic design shall be used to the greatest extent possible in primary laboratory areas that do not require customization. The goal is to maximize interchangeability of uses and minimize the need for renovations when changes in function occur. A generic approach should also be applied to typical support labs, administrative areas, and other repetitive elements of the design.

**B. Modular Design:** A laboratory planning module shall be employed in the organization of a laboratory to maximize efficiency of space use, economize construction cost, and standardize location of partitions, furnishings, and utilities. See [Section 2.2.2 Modular Design](#).

**C. Open Laboratory Design:** Open laboratories are large labs in which many modules are contiguous and open to each other. Open laboratories are an efficient use of lab space, provide opportunities for collaboration and are more easily reassigned without changes to the space and utilities. Open bay laboratories shall be used to the greatest extent possible in areas where compartmentalization is not required for programmatic or scientific reasons such as security, containment of occupational hazards, regulatory restrictions, environmental separation, etc. See [Section 2.2.3 Laboratory Areas](#).

**D. Laboratory Furnishings:** Where practical, laboratory furnishings shall be flexible and/or movable, to allow for reconfiguration without major renovation. Modular systems shall be utilized that permit interchangeability of components or substitution of equipment for bench elements. Benches shall have the capability to be raised or lowered (i.e., high bench, low bench) to meet changing needs and provide accessibility. Movable bench tops shall be locked in place for stability. Above the bench, a modular, adjustable system of shelving or enclosed cabinets shall be used, providing interchangeability of storage elements. Utility services shall be delivered to benches via overhead service carriers, service connections, or umbilicals that allow for accessibility for change.

**E. Utility Systems:** Laboratory areas shall be reconfigurable without major alterations to the utility systems. Modular distribution modes shall be provided that allow individual areas to be shut down for alteration or repair without disruption to adjacent areas. Utilities in a biosafety level 3 (BSL-3) lab, ARF, and other sensitive areas shall allow for complete access to all components requiring service and maintenance without entering these areas.

**F. Expansion:** Building systems must be readily expandable, consistent with the master plan. The degree of expandability shall be determined early in the design process. Provisions shall be made for future utility service expansion, both vertically and horizontally, to accommodate increased demands. Reserve capacity

shall be designed into the building utility systems such as vertical shafts to accommodate future growth and change. Spare capacity shall be designed into the building systems to allow researchers flexibility to add equipment and instrumentation as required.

*Rationale: Flexibility and adaptability ensures that a laboratory can meet evolving research needs and functional changes, and accommodate changing technologies in scientific procedures.*

### 2.1.3.7 Occupational Health and Safety

#### 2.1.3.7.1 Risk Assessment and Biosafety Level (BSL) Criteria

Risk assessment, in the context of Occupational Health and Safety, is the exercise of identifying, evaluating and mitigating potential hazards, and the basis for safeguards developed by the Centers for Disease Control (CDC), the NIH, and the microbiological and biomedical community to protect the health of laboratory workers and the public from the risks associated with the use of hazardous biological agents and or toxins. The risk assessment process considers both biological agent and laboratory procedure hazards to determine the appropriate BSL as well as other precautions. Laboratory biosafety levels (BSLs/ABSLs) are designated in the BMBL in ascending order (BSL-1/ABSL-1 to BSL-4/ABSL-4) by degree of protection provided to personnel, the environment, and the community to enhance worker safety, environmental protection, and address the risk of handling agents requiring increasing levels of containment. BSL criteria address standard microbiological practices, special practices, safety equipment, HVAC and pressure differentials and laboratory facilities' design. For additional information about risk assessments, refer to [Section 1.15.6 Risk Assessment, Systems Failure & Disaster Mitigation](#).

Although laboratory planners are primarily tasked with the facility design, referred to as the “secondary barrier” (safety equipment being the primary containment barrier), it is critically important to understand that laboratory standard practices, special practices, and safety equipment all contribute to an integrated

biosafety approach and have an impact on the design. All laboratories designed for the NIH shall be designed to BSL-2 as a minimum standard in accordance with the latest edition of the *Biosafety in Microbiological and Biomedical Laboratories (BMBL)*.

*Rationale: Risk assessments are crucial for identifying the risks that are inherent with working with biological material and developing the appropriate safeguards.*

#### 2.1.3.7.2 Biological Safety Cabinets (BSCs) and Fume Hoods

BSCs used in concert with appropriate practices, procedures, and administrative controls provide the primary containment for potentially infectious microorganisms. Similarly, fume hoods provide personnel protection from chemical hazards. Use of BSCs shall comply with Appendix A of the *BMBL*.

Placement of fume hoods and BSCs in laboratories shall be in accordance with the Biological Safety Cabinet Placement Guide ([Appendix A](#)), and in consultation with DOHS and take the following factors into account:

**A. Location:** Fume hoods and BSCs may not be located along circulation aisles or egress pathways within the lab, across from write-up desks, or other areas where turbulence from passersby might interfere with airflow, or hood fires might block egress pathways. Locations in dedicated alcoves, equipment rooms or aisle ends are preferred.

**B. Clearances and Guidelines:** Clearances from nearby partitions, other containment hoods and cabinets, HVAC diffusers, and other items that may cause turbulence within the device, or disrupt airflow, shall be maintained.

Guidelines for the placement of these devices are provided in *Methodology for Optimization of Laboratory Hood Containment – Volumes I and II*, November 1996, Farhad Memarzadeh, PhD, PE, NIH – Office of the Director, Bethesda, MD (<http://orf.od.nih.gov/PoliciesAndGuidelines/Bioenvironmental/Pages/lab-hoodcontainm.aspx>)



### 2.1.3.7.3 Chemical Storage

Acid cabinets and flammable material storage cabinets shall be located diametrically opposed from each other and towards the back of the laboratory away from the laboratory entrance. The design is to additionally comply with the guidelines given in [Section 1.11 Environmental Management and Radiation Safety](#) and referenced NFPA codes and standards.

### 2.1.3.7.4 Waste Management

Each laboratory area shall be provided with designated space for the safe storage of biological, chemical and radioactive hazardous waste. Additionally, space shall be allocated for storage of non-hazardous waste and recyclable containers. For additional information about waste management, refer to [Section 1.11 Environmental Management and Radiation Safety](#).

### 2.1.3.7.5 Radioactive Work Areas

A secure, segregated space must be provided for radiation work. Access is required to a chemical fume hood designed for radionuclide work, emergency shower, hand wash sink, and eyewash, and flammable solvent storage cabinet. Space shall be provided for storage of wet and dry radioactive waste containers of different types. Proper shielding shall be provided based on the type of isotope(s) to be used in the laboratory.

### 2.1.3.7.6 Additional Safety Requirements

**A. Sink, Eyewash and Storage Cabinet:** Each wet laboratory requires a hand wash sink near the exit door, emergency eyewash, and Underwriters Laboratories (UL) rated flammable storage cabinet.

**B. Directional Airflow:** Directional airflow is required to ensure that air moves into the laboratory from adjacent non-lab areas and towards more contaminated areas within the lab. Directional airflow is also used to protect research from potential cross-contamination. Airflow diagram illustrating directional airflow at each doorway is required to communicate intent among architects, engineers and users.

**C. Emergency Shower and Cabinet:** Laboratories where fume hoods are located or corrosives are handled shall be equipped with a emergency shower and corrosive

storage cabinet. All labs, regardless of use, shall be within code-required distance of a emergency shower.

**D. Safety:** Location of “sharps” containers and other disposal containers must be convenient to the work to be performed and minimize possibility of injury (e.g., needlesticks) due to awkward position/impaired visibility, excessive distance, etc.

### E. Ergonomics:

1. Lab casework must have appropriate ergonomic design and equipment to minimize musculo-skeletal strain, including cutouts for microscopy and other tables requiring close/precision work, anti-fatigue mats where prolonged standing may be required, and fully adjustable chairs with lumbar support, and arm and leg rests where necessary (to avoid arm compression on counter edges, suspended legs).
2. Computer workstations must be suitable for the work performed. They should promote a neutral position of torso and limbs, space for a fully articulating keyboard tray with mouse platform, and fully adjustable chairs with adjustable seat and lumbar support, flexibilities to accommodate different handedness, height, and weight, and to minimize repetitive stress, awkward postures, and glare from lighting.

### 2.1.3.7.7 Additional Design Considerations

**A. Noise:** Noise-sensitive areas including microscopy, microinjection and other functions that require a high degree of manual precision or mental concentration shall be physically and/or acoustically isolated from noise sources.

**B. Vibration:** Excessive vibration caused by mechanical equipment or inadequate structural stiffness and stability can adversely affect a building’s capacity to house advanced research equipment and procedures. Structural and mechanical dampening is required to minimize impact on sensitive scientific instrumentation and animal health. In new buildings, consideration should be given to the selection of an optimal building structural system that provides the required vibration performance in large areas of the building, providing equipment placement flexibility. In existing and renovated buildings, highly sensitive equipment may need to

be located on ground-floor slabs or on specially designed isolated slabs. Design analysis and/or on-site testing may be required to ensure that the building meets performance requirements. Vibration dampening tables or locations within more vibration-stable parts of the building may be considered in renovations and other cases where existing conditions require vibration mitigation.

**C. Odor:** Design considerations should be given to isolating functions which produce odors. Directional air-flow, exhaust hoods and other means shall be utilized to mitigate and contain unpleasant and irritating odors.

**D. Signage, Wayfinding, and Graphics:** Directional graphics and wayfinding signage shall be provided to enable navigation within and around the building. Signage shall identify hazards, building features, and components. Interior signage shall be designed in accordance with [Appendix M: Interior Signage Manual](#).

**E. Artwork:** Consideration shall be given to locating, supporting, and illuminating permanent and temporary artwork in public spaces. Artwork in labs and other specialty spaces is discouraged.

### 2.1.3.8 Laboratory Types

Although each laboratory project has unique requirements and attributes, many of the component laboratory space types can be characterized in generic terms based upon common features and usage. Typical research laboratories are categorized as wet, dry, support, and special function.

**A. Wet Laboratories:** Wet laboratories house functions that include work with solutions or biological materials. They typically utilize benches, sinks, chemical fume hoods, and/or BSCs. Wet labs are generally outfitted with a full range of piped services and supporting utilities. The types of wet laboratories found at the NIH include but are not limited to:

1. Microbiology
2. Cellular biology
3. Molecular genetics
4. Pathology
5. Biochemistry
6. Organic chemistry

7. Structural biology
8. Electrophysiology

**B. Dry Laboratories:** Dry laboratories typically house computers, electronics, and instrumentation that do not require wet services or the use of chemical or biological agents. They may be used for computer simulation, mathematical analysis, and other research that can often be housed in office-like space with enhanced electrical and IT support. Types of dry laboratories found at the NIH include but are not limited to:

1. Robotics
2. Optics
3. Imaging
4. Bioinformatics
5. Computational

**C. Support Laboratories:** Support laboratories are special use labs that are separated from the primary laboratories due to equipment noise or heat generation, intermittent use, use as shared resources or other factors. Support labs must be located near the primary labs that they serve or research process required. Equipment size and type, rather than personnel or bench needs, will often determine the size of support labs. Increased floor loading capacities, supplemental cooling, and higher ceilings may be required for special equipment. Support labs are often “core” facilities, providing shared support to multiple lab groups. Support labs include but are not limited to:

1. Equipment room
2. Instrument room
3. Tissue culture lab
4. Autoclave/glass wash
5. Environmental room
6. Darkroom
7. Electron microscopy
8. Confocal microscopy
9. Optical microscopy

10. Optical/laser laboratories
  11. Nuclear magnetic resonance laboratories
  12. Robotics laboratories
  13. Fermentation laboratories
  14. PCR room
  15. Cleanroom
  16. Histology lab
  17. Radioisotope lab
  18. Other rooms with procedures sensitive to contamination
3. Overview of planning objectives and goals
  4. Space, staffing, and equipment data garnered from user interviews and questionnaires
  5. Code review, summary and statement of project compliance
  6. Budget estimate
  7. Room data sheets
  8. Equipment schedule
  9. Summary of existing conditions

**B. Renovations Between a \$2 and \$5 Million Estimated Construction Cost and All New Construction Projects:** Projects shall include a more comprehensive programming study that includes all requirements listed in (A) above, plus relational and systems diagrams, and site planning analysis if applicable.

**C. Renovations and New Construction Over a \$5 Million Estimated Construction Cost:** Projects shall include a full POR. The POR shall include all requirements listed in (A) and (B) above, and shall be in general compliance with U.S. Department of Health and Human Services (HHS) regulations.

Reference the project contract for specific project requirements.

---

## 2.1.4 Predesign Deliverables

Required deliverables vary based on the size and complexity of individual projects:

**A. Renovation Projects Under a \$2 Million Estimated Construction Cost:** Project shall include a BOD report, which shall include all information required to define the objectives and design intent of the project, including but not limited to:

1. Statement of Work (SOW)
2. Narrative description of the project

# Section 2.2

## Research Laboratory Design

---

### Contents

#### 2.2.0 Introduction

#### 2.2.1 Conceptual Design Considerations

##### 2.2.1.1 Organizational Issues

##### 2.2.1.2 Operational Issues

##### 2.2.1.3 Infrastructure Issues

#### 2.2.2 Modular Design

##### 2.2.2.1 Module Dimensions

##### 2.2.2.2 Modular Utility Distribution

#### 2.2.3 Laboratory Areas

##### 2.2.3.1 Primary Laboratories

##### 2.2.3.2 Support Laboratories

#### 2.2.4 Personnel Support Areas

##### 2.2.4.1 Offices

##### 2.2.4.2 Lobbies

##### 2.2.4.3 Locker and Shower Areas

##### 2.2.4.4 Conference Rooms

##### 2.2.4.5 Storage Areas

##### 2.2.4.6 Break Areas

##### 2.2.4.7 Interaction Areas

#### 2.2.5 Circulation Areas

##### 2.2.5.1 Security

##### 2.2.5.2 Logistics

##### 2.2.5.3 Ghost Corridors

#### 2.2.6 Building Operation Areas

##### 2.2.6.1 Housekeeping Closets

##### 2.2.6.2 Material Handling Areas

##### 2.2.6.3 Shipping and Receiving Areas

##### 2.2.6.4 Hazardous Material Waste Rooms

#### 2.2.7 Utility Distribution

#### 2.2.8 Conceptual Design

#### 2.2.9 Room Data Sheets

## 2.2.0 Introduction

This section outlines the design requirements for laboratory construction projects. The design requirements must be obtained from concepts, parameters, and data outlined in [Section 2.1 Research Laboratory Pre-design](#). Refer to [Appendix F: Room Data Sheets](#) and discipline-specific chapters for additional information.

## 2.2.1 Conceptual Design Considerations

The design of laboratory projects must integrate organizational, operational, and infrastructure challenges with innovative, thoughtful design to create workplaces that are equally functional and inspirational for a scientific community tasked with innovation and discovery.

### 2.2.1.1 Organizational Issues

**A. Functional Zoning:** Functional zoning of primary components, including administrative areas, lab and lab support areas, personnel support areas, animal research areas, logistical support areas and other functions shall be organized in a rational way that reflects the lab's workflow, increases efficiency, provides opportunities for interaction and reduces conflicts.

**B. Interrelationship:** Interrelationship of functional components within each zone shall create adjacencies and proximities promoting efficiency, collaboration and the use of shared equipment, assets and amenities.

**C. Blocking and Stacking of Program Elements:** Programs and program elements shall be located horizontally, vertically and in relationship to each other based on a rational approach to circulation (staff, material and visitors), efficiency and function.

**D. Efficiency Assessment:** Assess the quantities and arrangement of the building corridors, vertical circulation, utility spaces, shafts and other non-program components to optimize efficiency of function as well as overall building efficiency.

### 2.2.1.2 Operational Issues

**A. Circulation:** Consideration for the efficient circulation of visitors, staff, materials, animals, equipment and waste among zones is a key to functioning of a well designed research facility. An approach shall be developed that enlivens the facility, provides opportunities for interaction, minimized conflicts, reduces travel distances and addresses safety, security and other operational concerns.

**B. Workflow:** An approach for the smooth, efficient and safe flow of materials and people must be developed at a building level, and at a floor, wing and individual lab level.

**C. Logistical Support:** Loading docks, freight and service elevators, service corridors, storage rooms, recycling, waste storage and other components of logistical support must be adequately sized and conveniently located to promote efficient operations.

**D. Security:** Security features, including guard stations, locations for security equipment and devices, card and biometric scanners shall be confirmed with the Division of Physical Security Management (DPSM).

**E. Occupational Safety:** The locations and detailing of emergency showers, eyewashes and all other safety devices shall be reviewed and approved by the Division of Occupational Health and Safety (DOHS).

### 2.2.1.3 Infrastructure Issues

**A. Capacities, Location, and Size of Primary Utility Systems:** System locations and configurations shall be flexible, economical, maintainable and suitable for expansion and modification. Major utilities shall be located in columns, and continuous shafts, and not located within partitions of program areas. Refer to requirements of each section of the *DRM*.

**B. Utility Distribution Methodology:** The distribution system should be rational, organized, and module-based.

**C. Maintenance Access Methodology:** Access and clearance shall be provided to allow for maintenance. A configuration that allows access from outside of the lab shall be the goal of all facilities and is essential in ARF and biocontainment facilities.

**D. Redundancy/Emergency Utilities:** Redundancy and emergency capacities should allow for continued operations during emergency and failure scenarios upon failure of any critical component.

**E. Future Load Capacity:** Additional capacity should be provided to allow additional equipment, changing use and expansion of programs. Additional capacity shall be agreed with the PO during the POR stage of the project.

**F. Security:** Infrastructure should be designed to be tamper resistant and secure in accordance with DPSM requirements.

**G. IT and Communications:** Telephone data and network rooms shall be adequately sized, centrally located, stacked, and in sufficient number so that recommended distances are not exceeded. A minimum of one room per floor shall be provided. Rooms shall be dedicated, and not shared with other building services. Refer to [Chapter 11: Telecommunication Systems Design](#).

**H. Leak and Flood Prevention:** Floors of mechanical rooms and interstitial levels shall be designed to prevent leaks. Corrugated metal decks and other assemblies that cannot be waterproofed are not acceptable. Penetrations through the floor shall be protected by raised curbs or sleeves or otherwise configured to contain water and prevent leaks.

## 2.2.2 Modular Design

The laboratory module is the fundamental organizational basis of a laboratory building. It is a generic building block used to configure many types and sizes of labs, establish circulation and bench arrangements within labs, assign space, ensure efficient space use, maintain flexibility, guide utility distribution, and maintain overall design integrity. All lab areas shall be organized on a modular basis free of stairwells, chases, shafts, shear walls, elevators, and other obstructions to the greatest extent possible.

### 2.2.2.1 Module Dimensions

Module dimensions are based on the configuration of a typical double-loaded laboratory bay with benches or equipment skirting each side of a central aisle. NIH

has established 3.4 m (11 ft.) as a standard module offering versatility, efficiency, and flexibility in most biomedical laboratory settings. Optimum module width is dictated by an aisle of 1.5 m (5 ft.), plus 762–914 mm (2 ft. 6 in.–3 ft.) of bench or equipment on each side of the aisle. Aisle widths exceeding 1.8 m (6 ft.) are discouraged because they tend to accumulate stored equipment, materials, carts, and impromptu work counters that inhibit safe working clearances and egress pathways. Because module dimensions are measured from center lines, the thickness of demising partitions and columns must also be taken into consideration. Architectural Barriers Act Accessibility Standard (ABAAS) clearance requirements at doorways, aisles and other elements shall be met. Module considerations should also include height (floor to floor) to allow for utility flexibility.

For new laboratory construction projects, a 3.4 m (11 ft.) laboratory module shall be used. More discretion is acceptable for renovation projects where existing structure, utility shafts, and immovable walls must be taken into consideration.

Spatial versatility and flexibility is further enhanced by applying the modular concept to a two-dimensional grid dimension (width and depth), thereby allowing laboratories to be configured transversely across multiple modules without loss of efficiency or aisle clearances. The typical NIH module should be configured in 3.4 m x 3.4 m (11 ft. x 11 ft.) increments, with a depth of 10.1 m (33 ft.) providing optimal layout flexibility. [Figure 2.2.2.1](#) illustrates this concept.

**Figure 2.2.2.1 Laboratory module configuration**

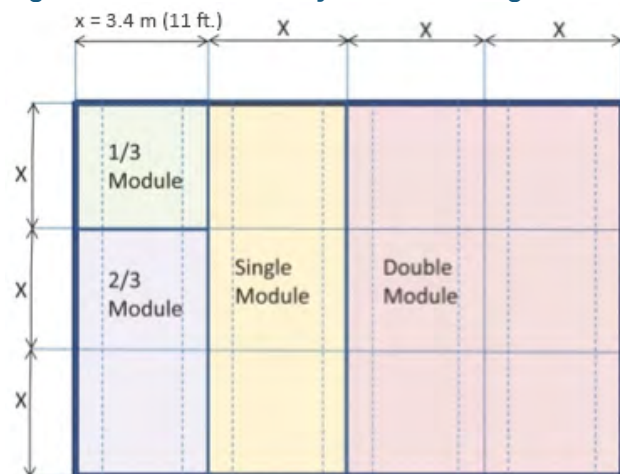



The basic module can be applied to most functional areas within the laboratory zone. Laboratory support, research offices, circulation, and building support spaces should all be organized to work with the module to the greatest extent possible.

Some laboratory types may require special consideration due to exceptionally large equipment, such as low-temperature freezers and optical tables, or wide-equipment working clearances such as BSCs. Similarly, custom bench arrangements for electronics labs and other special-use research spaces may not conform to the standard module. These areas may need to be configured “off-module“ on a case-by-case basis. Nevertheless, with the exception of purpose-built facilities, every effort should be made to retain the basic modular structure that suits most of the programmed laboratory types.

### 2.2.2.2 Modular Utility Distribution

Laboratory services shall also be distributed on a modular basis with connection points provided to each individual laboratory module. The connection point of each service shall be located in a uniform position relative to the module and detailed to allow for extension into the laboratory without disruption of adjacent modules. Modular utility connection points shall be located in corridors or utility areas to the greatest extent possible so that maintenance and modifications may be performed without entry into occupied labs. Utility distribution systems shall be configured to allow individual modules and labs to be serviced or disconnected without affecting the capacity or location of central infrastructure systems.

The use of an interstitial level for utility distribution has many advantages, including increased flexibility and adaptability. Interstitial distribution minimizes the disruption of ongoing research by maintenance, renovation and other utility activities, and can provide space for LAN/Telecommunications rooms and other functions.

## 2.2.3 Laboratory Areas

### 2.2.3.1 Primary Laboratories

Primary laboratories provide dedicated space for investigator benches and equipment. A minimum of 1.8 m–2.1 m (6–7 ft.) of high bench is required per investigator. Space is also required for shared equipment in close proximity to the bench space, such as small bench-mounted apparatus, lab sinks, fume hoods, refrigerators, freezers, etc. Primary laboratories may also include desk space for the investigator.

The access path to primary laboratories must include dedicated space for the storage of personal belongings, and space for the storage and donning of PPE such as lab coats, eye protection, gloves, and other items that may be required, as well as a hand wash sink for investigators to use upon leaving the lab. In large labs the hand wash sink is in addition to the laboratory sink(s).

**A. Open Laboratories:** Open configurations with few partitions between researchers should be considered for most primary laboratories. Open laboratories provide an environment that is conducive to communication and encourages interaction among researchers. Investigators are assigned benches rather than rooms, improving flexibility for space assignment and program changes. Primary labs are the principal workplace for many investigators, and should be provided with natural lighting and views. Depending on the building’s design, open laboratories can also help distribute natural lighting and views to most or all of the laboratory staff by placing primary research spaces along the exterior of the building.

**B. Closed Laboratories:** The potential disadvantages of open laboratories are acoustics and reduced privacy and security. If these are primary requirements, closed laboratories should be considered. Closed laboratories consist of a small number of lab modules (usually one to three) separated by walls from other laboratories.

**C. Laboratory Requirements:** At a minimum, all labs shall follow BMBL requirements. Depending on the function of the lab, the following elements are often required in each primary laboratory:

1. One laboratory sink per two to three lab modules with an adjoining bench for staging, eye-wash, pegboard, and graduated cylinder drying

rack. At least one sink within each primary lab must be large (762 mm wide x 406 mm deep [30 in. wide x 16 in. deep]) and equipped with an overhead shelf, power supply, and a pure water connection for water polishing equipment.

2. A location near the entry for lab coats and other PPE as designated by program requirements. If powered air-purifying respirators (PAPRs) are used provide provisions for charging, storage and decontamination. Laboratories must have a sink for handwashing located near the laboratory exit door for use prior to exiting.
3. At least one flammable storage cabinet in each wet laboratory and wherever flammable materials are used. Flammable storage cabinets shall be UL rated and shall not be located under fume hoods. Refer to [Section 9.1.6 Flammable Liquid Storage Cabinets](#) for additional information.
4. All labs that house fume hoods require vented corrosive storage cabinets, typically located below the fume hood, and emergency showers.
5. Designated space for location of waste containers, including an area for medical pathological waste (MPW) and hazardous chemical waste
6. Space to locate wall mounted gas cylinder restraints, as needed

### 2.2.3.2 Support Laboratories

Support laboratories house equipment and procedures that do not require immediate adjacency to investigator benches. The type and number of required support laboratories is program driven and may include equipment rooms housing low-temperature freezers, centrifuges, shakers, autoclaves, and other items that are shared by multiple investigators; areas such as tissue culture labs that require environmental containment as well as specialized equipment; and areas for other specialized functions requiring isolation, containment, or separation. Some support labs are dedicated to specific investigators or groups; others may be shared across lab groups. Core support labs may support multiple groups and may have dedicated operational staff associated with the lab.

With the exception of core laboratories serving a wide array of lab groups, support labs should be located as closely as possible to the groups that use them. Investigators should be able to access most support labs without leaving the laboratory zone. The ability to pass directly from the primary lab to a support lab can be essential for safety, security, or process workflow reasons. The following support lab functions and equipment are typical for NIH laboratory projects:

1. Autoclave for decontamination of infectious waste (minimum one per floor), with canopy hood and floor drain
2. Icemaker with floor drain
3. Dry ice storage chest
4. Equipment room for locating noise producing or heat-generating equipment that would be disruptive in the primary lab environment
5. Environmental room
6. Dark room
7. Cold room
8. Tissue culture

## 2.2.4 Personnel Support Areas

### 2.2.4.1 Offices

Office space is an integral part of the laboratory operation, and should be located near the laboratory zone.

Office areas typically consist of space for laboratory personnel, administrative areas for non-lab staff, and conference rooms. In some cases, office space may also be required for analytical and computational areas, server rooms, and other dry lab functions. There are many organizational models that foster this relationship including a separate office zone adjacent to the lab zone, distributed office pods within each laboratory neighborhood, and linear office zones that parallel lab zones.

Consideration should be given to clustering administrative non-lab offices to facilitate sharing of support staff.

Space must be included for records/files, copiers, and mail areas. Office and file rooms should be lockable. Space for paper recycling containers and/or shredders should be provided.

Administrative non-lab offices benefit from separation from the lab environment for the following reasons:

1. Occupational safety, by virtue of separation from the more hazardous lab zone arranged from least restrictive to most restrictive
2. Energy-efficiency, as one-pass air is not required in office areas
3. Consumption of food and drink is prohibited within the lab zone
4. Unescorted visitors may not be allowed within laboratories

Laboratory chiefs, section chiefs, principal investigators, and senior scientists should be provided with dedicated offices wherever possible. Primary office space for some or all of these staff should be placed such that visitors do not have to enter the lab zone to gain access.

Postdoctoral fellows and technicians may be assigned semiprivate offices or cubicle workstations. Write-up desk areas typically are located within the primary labs to facilitate work, and are often located adjacent to dedicated high bench space. A minimum of 1.2 m (4 ft.) of desk space is required per investigator for write-up. Organizational models that provide separation of write-up desks from lab benches include ghost corridors or partitions of glass or other materials. At a minimum, splash guards are required between desk and bench surfaces.

#### **2.2.4.2 Lobbies**

An entrance lobby shall be provided at the main entrance to the building and shall have a seating area, bulletin boards, and a telephone to contact building occupants. Signage and a building directory shall be provided to facilitate wayfinding. A vestibule shall be provided at the lobby entrance to enhance energy conservation and to minimize dirt and moisture from being tracked into the facility. A reception/security workstation shall be provided if included as a program requirement. Provide close access to public restrooms from the lobby.

Seating areas should also be considered adjoining elevator lobbies, laboratory branch offices, and other locations for visitor waiting and informal staff interaction.

#### **2.2.4.3 Locker and Shower Areas**

Lockers of adequate size and number should be provided for personal item storage outside of the laboratory. Lockers may be located in corridors, break rooms, or dedicated locker areas.

Showers with changing areas should be provided for larger building projects and when required by the building program or sustainable design goals. Shower and changing areas are typically adjacent to or co-located with restrooms. Include lockers and changing benches, clothes hooks, shelves, mirrors, and electrical outlets adjacent to the mirrors. Shower and changing areas shall be accessible to individuals with disabilities. Refer to the local plumbing code to determine the number of fixtures required.

#### **2.2.4.4 Conference Rooms**

The total number and size of conference rooms is program driven. Small conference rooms for 8–10 people shall be provided for section-level staff meetings. Larger conference rooms for up to twenty-five people shall be provided for laboratory branch meetings. All conference facilities shall be shared. Each space should be equipped with white-board, floor and ceiling outlets to accommodate audiovisual and projection equipment (laptop and overhead projectors) or large display, light dimming and blackout control, as well as telecommunications/local area network (LAN) capabilities. Conference rooms should be equipped to accommodate flexible seating arrangements, secure storage closets or cabinets, space for waste and recycling containers, and accessibility to permit ease of cleaning and access. The need and size of conference rooms for over forty-nine people shall be designed according to NIH Events Management requirements.

#### **2.2.4.5 Storage Areas**

Dedicated storage rooms should be provided for storage of supplies outside of laboratories so that material does not accumulate in corridors and overfill laboratory aisles and shelving. See [Section 1.11 Environmental Management and Radiation Safety](#) for hazardous material storage requirements.

### 2.2.4.6 Break Areas

Break areas are required on each floor so employees may consume food and beverages in a dedicated space. They should also be designed to foster informal interaction through the use of whiteboard, tack board, tables, and seating. Break rooms shall be equipped with a refrigerator/freezer, a kitchenette with sink, a microwave oven, garbage disposal, and lockable cabinets. Space should be designated for waste and recycling containers. These containers shall be adequately sized to support the occupancy of the space and be constructed of durable cleanable materials. Break areas shall be accessible without passing through laboratories to allow access by administrative personnel and to facilitate cleaning. Break rooms shall be provided with exhaust ventilation to prevent migration of cooking odors to other areas. Sufficient electrical outlets and counters shall be provided for small appliances and food preparation.

### 2.2.4.7 Interaction Areas

In addition to formal conference and break rooms, facilities should include areas for informal meeting, impromptu discussions and other areas for staff interaction. Areas should be at convenient locations, and should include seating, white boards, and other meeting amenities.

---

## 2.2.5 Circulation Areas

Minimum corridor width shall be 1.5 m (5 ft.) clear or code required width based upon occupant load for primary egress, whichever is greater. Wider corridors may be required in larger facilities for general circulation, and to accommodate transport of large laboratory equipment. The movement of such items through proposed corridors shall be verified with user groups. If corridors are designed to support equipment, they must be appropriately designed and cannot be used for primary egress. Corridors shall not accommodate the storage of hazardous or flammable materials.

Corridor alcove space shall be identified for general waste-recycling containers, if allowed by code. Corridors in excess of 1.8 m (6 ft.) width are discouraged as they tend to accumulate equipment and furnishings that may be unsupportable by corridor utility systems.

Building corridors shall be furnished with signage to facilitate wayfinding. See [Appendix M: Interior Signage Manual](#).

### 2.2.5.1 Security

The corridor system must facilitate the security strategy which generally requires progressive layers of access control for higher hazard areas. Egress corridors must always fail-safe in the direction of egress travel. Public areas must be easily secured from other areas of the building. The laboratory zone shall be securable from administrative areas. Higher hazard areas within the laboratory zone shall also be securable. Coordinate security requirements with DPSM.

### 2.2.5.2 Logistics

Movement of materials and laboratory research animals from loading dock facilities to multiple points of use must be evaluated in development of the overall building circulation system with SOPs developed for movement of clean and dirty material. Pathways shall be identified for delivery of materials, removal of waste, and movement of large equipment, including the number and size of freight, service, and passenger elevators. In projects that require freight elevators, a separate pathway may be considered from the loading dock to the laboratory zone. Pathway analysis shall include turning radii, height and width of all components (corridors, doorways, elevator doors, elevator cabs, etc.) to ensure the movement of the largest anticipated equipment.

Secure service corridors may be provided adjoining laboratory spaces that distribute utility services into the laboratories via the ceiling or directly to the lab bench through the wall of the service corridor. Service corridors shall be a minimum of 1.5 m (5 ft.) in clear width plus any utility and storage areas, and shall be designed to accommodate required turning radii. Service corridor may be used for deliveries, pickup, gas cylinder storage, and general common use space. Service corridor floors and walls shall be designed for heavy wheeled traffic and impact resistance.

### 2.2.5.3 Ghost Corridors

Ghost corridors are internal aisles within open laboratories that interconnect laboratory modules and improve circulation within the laboratory. Ghost corridors can

provide secondary emergency exit for laboratories; however, they are not the primary fire or emergency exits. Ghost corridors can also provide a degree of internal separation between different lab functions such as high bench investigator areas and adjacent write-up desks. The clear width of ghost corridors shall be a minimum of 1.1 m (3 ft. 8 in.).

---

## 2.2.6 Building Operation Areas

Building operation areas consist of space that is not necessarily associated with the scientific activities of the laboratory but required for a functional and well designed laboratory. Building operation areas include circulation, toilets, shipping and receiving areas, mechanical and electrical rooms, telecommunications, hazardous waste holding room, and utility distribution areas.

### 2.2.6.1 Housekeeping Closets

All buildings must be equipped with appropriately sized housekeeping closets located throughout the facility. A housekeeping closet must be negatively pressurized to reduce humidity and control odors. Closets should be fitted with shelving, mop and broom hangers, a floor sink, ground fault interrupter (GFI) receptacle and adequate lighting. Closets should be sized to hold cleaning supplies and equipment only. Space within housekeeping closets for storage of unrelated items is not allowed. The interior of the closet must be finished with materials and surfaces that are cleanable, moisture resistant, and durable. Backflow prevention is mandatory on hose bibs.

### 2.2.6.2 Material Handling Areas

Dedicated areas for staging and disposal of laboratory materials and hazardous waste shall be provided adjacent to service elevators when required by the Occupational Safety and Health Administration (OSHA) standards or other applicable regulations. When required, these areas shall be located within each building zone with separate areas for chemical and hazardous waste storage.

### 2.2.6.3 Shipping and Receiving Areas

The loading dock shall have adequate space for proper marshaling, inspection, and cleaning of materials received and shipped from the building. When programmed, a small office shall be provided for personnel responsible for tracking the distribution of material. In larger facilities consideration should be given to providing a toilet to delivery people and staff. In multistory facilities, consideration should be given to locating material handling zones at each floor. Separate and dedicated space shall be provided for animal receiving and carcass disposal if the building has animal facilities. Refer to [Section 4.8 Loading Docks](#), and [Section 4.7 Vertical Transportation](#), for additional information.

### 2.2.6.4 Hazardous Material Waste Rooms

Chemical waste rooms, biologic waste rooms and radiologic waste rooms shall be provided with card access-control only. Sizes for these areas shall be based on calculated throughput, but no less than the minimum sizes established by the NIH. See [Section 1.11 Environmental Management and Radiation Safety](#). The PO shall check with the Division of Environmental Protection (DEP) for Certificates of Compliance.

- A. Recycling Room:** Provide a recycling room, preferably outside the loading dock.
- B. Recycling Container and Compactor:** Provide cardboard recycling containers bolted to the loading dock and a cardboard compactor.
- C. Tank Farms:** If required tank farms (areas housing gas and other types of tanks) shall be provided with restraint brackets at each loading dock with appropriate setbacks from the building.
- D. Fire Extinguisher:** Provide fire extinguishers in accordance with [9.4.3 Fire Extinguishers](#).
- E. Safety Shower and Eyewash Station:** Provide a safety shower and eyewash station with no floor drain.
- F. Electrical Outlets:** Provide one duplex electrical outlet on each wall of the room. All electrical appurtenances in the room shall comply with local requirements.



**G. Telephone Outlet:** Provide a wall-mounted telephone either in the room or immediately outside for emergency communications.

**H. Finish:** Provide epoxy coating finish for the entire area with appropriate safety/hazard markings.

**I. Biomedical Laboratory Loading Docks:** Provide space in the area of the loading dock for the collection and storage of medical pathological waste (MPW), chemical waste, and radiologic waste. A cold box capable of holding a minimum of thirty MPW boxes overnight shall be supplied in close proximity to the loading dock. See [Section 1.11 Environmental Management and Radiation Safety](#).

**J. MPW Waste Collection Stations:** Space must also be provided for MPW collection stations on each floor of laboratory buildings and as directed by the DEP.

---

## 2.2.7 Utility Distribution

Systems delivering power, data, ventilation, plumbing, and specialty gases are crucial to a laboratory. Distribution and maintenance access strategies for these systems have a profound design impact and must be demonstrated at the conceptual planning process. Utility systems shall be organized in vertical and horizontal zones and delivered to the laboratories on a modular basis that allows for flexibility, service accessibility, future expansion, and uniform availability of services.

Conceptual and schematic design submissions shall include diagrams illustrating the coordination of architectural, structural, and engineering elements in both plan and section to demonstrate the utility distribution methodology and verify that adequate space is provided to house and service utility systems while maintaining minimum program clearances. All utilities shall be placed at approved, permanent locations in accordance with requirements of individual sections of the *DRM* and shall be configured to minimize potential of disruption, including during failure, service, and renovations.

Locations, sizes and clearances for electrical equipment (including transformers, distribution equipment, electrical closets) shall be in accordance with requirements in [Chapter 10: Electrical Design](#).

## 2.2.8 Conceptual Design

The conceptual design process shall explore a range of design alternatives so that the most advantageous solution can be selected for continued development. Conceptual design alternatives shall include the following elements for use in comparative analysis:

1. Floor plans showing functional zones and program areas
2. Diagrammatic section, showing functional zones and relationships
3. Circulation diagrams for personnel, materials, waste, and research animals (if applicable)
4. Modular design approach
5. Limited access points
6. Room data sheets for each laboratory space
7. Utility distribution approach (plan and section)
8. Listing of net and gross areas
9. Estimated construction and project costs with appropriate contingency
10. Project schedule
11. Sustainability requirements, goals and approach
12. Equipment schedule for each laboratory space

---

## 2.2.9 Room Data Sheets

Design requirements and criteria for typical space types found in NIH laboratory facilities is included in the Room Data Sheets in [Appendix F](#).



# Section 2.3

## Animal Research Facility Predesign

---

### Contents

#### 2.3.0 Introduction

#### 2.3.1 Animal Research Facility: Project Programming

##### 2.3.1.1 Project Parameters

##### 2.3.1.2 Data Collection

##### 2.3.1.3 Documentation

#### 2.3.2 Animal Research Facility Planning

##### 2.3.2.1 Location Considerations

##### 2.3.2.2 Space Requirements

##### 2.3.2.3 Contamination Control

##### 2.3.2.4 Functional Relationships

##### 2.3.2.5 Circulation

##### 2.3.2.6 Workplace Enhancement

##### 2.3.2.7 Flexibility

##### 2.3.2.8 Utility Systems

#### 2.3.3 Biological Risk Assessment and Biosafety Level Criteria

#### 2.3.4 Design Considerations

##### 2.3.4.1 Animal Holding Rooms

##### 2.3.4.2 Cage Wash Areas

##### 2.3.4.3 Storage

##### 2.3.4.4 Animal Intake and Quarantine

##### 2.3.4.5 Necropsy

##### 2.3.4.6 Surgical Suites

##### 2.3.4.7 Insectaries

##### 2.3.4.8 Aquatics

##### 2.3.4.9 Animal Imaging

##### 2.3.4.10 Behavioral Suites

#### 2.3.5 Plan and Program Deliverables

## 2.3.0 Introduction

This section describes the predesign requirements for animal biosafety level 2 (ABSL-2) research facilities. All NIH ARF facilities shall be designed to ABSL-2 requirements at a minimum. There are a wide range of animal facility types including small animal facilities used primarily for rodents and other small mammalian species; large animal facilities used primarily for cats, dogs, sheep, swine, non-human primates (NHPs), and other midsized mammalian species; farm animal facilities, breeding facilities, and others. Other animal facilities house fish, amphibians and insects. For ARF associated laboratory planning and programming, reference [Section 2.1 Research Laboratory Predesign](#). For ARF-specific requirements, adhere to the direction given in this section. Additional requirements for facilities supporting ABSL-3 research are included in [Section 2.5 Biocontainment Facility Predesign](#), and [Section 2.6 Biocontainment Facility Design](#).

NIH ARFs shall be planned to ensure the welfare of both research animals and facility staff. NIH facilities supporting animal use shall comply with facility standards presented in the latest edition of *The Guide for the Care and Use of Laboratory Animals*. The Association for the Assessment and Accreditation of Laboratory Animal Care International (AAALAC) bases its accreditation of animal care and use programs on the program's level of conformance with *The Guide* and the *Guide for the Care and Use of Agricultural Animals in Research and Teaching*.

Animals shall not be housed in laboratories or spaces other than approved animal housing facilities for a duration determined by the Institutional Animal Care and Use Committee (IACUC) or applicable authority unless the area is established as a satellite animal housing facility and meets the requirements of this section.

Stakeholders who should be involved in planning, in addition to those discussed in [2.1.0 Introduction](#) are veterinary, animal care, and animal facility management staff. These individuals are the primary users and may reside within the facility. Investigators utilizing research animals housed within the facility should be included to provide an understanding of research-specific procedures, equipment, and protocols that may affect facility design.

## 2.3.1 Animal Research Facility: Project Programming

Animal research facilities are process-driven workplaces. Material flow and standard operating procedures inform planning and design. Designers must verify the specific animal species to be housed, special procedures in place to ensure animal health and research integrity, animal husbandry processes, and other factors that impact requirements. ARFs may be designed to accommodate animals of varied sizes and species including small and large animals, aquatics, insectaries, and other less common animal models. Facilities shall be generically planned with the flexibility to accommodate multispecies housing to the greatest extent possible.

### 2.3.1.1 Project Parameters

Program development shall include identification of requirements and constraints that frame the project scope. The design team shall identify requirements during the programming phase that can be addressed appropriately in the design phase. Specific areas to be investigated are identified in [Section 2.1.2.1 Project Parameters](#). Additional areas of concern for animal facilities are as follows:

**A. Infrastructure:** Utility services serving animal facilities require enhanced performance for dependability, control, airflow, and redundancy. Infrastructure that is suitable for laboratories may not meet the requirements for animal facilities. Refer to Chapters 6 to 12 for engineering information.

**B. Schedule and Phasing:** Expanding or renovating existing, functioning animal facilities requires special consideration to ensure that ongoing operations are not disrupted or compromised because a variety of animal species are intolerant or sensitive to noise and/or vibration. Utility outages are also problematic because research animals should not be exposed to environmental fluctuation and cannot be easily moved.

### 2.3.1.2 Data Collection

A needs assessment shall be conducted, starting with completion of the Animal Research Facility Program Questionnaire ([Exhibit 2.2](#)). The program questionnaire collects data on the general mission of the animal facility, species and numbers to be housed, animal

health status, biosafety level(s), existing and projected staffing, procedure space requirements, cage-change regimen, equipment requirements, standard operating procedures, storage needs, and use/storage of hazardous chemicals, medical and pathological waste, biologics, and radiologicals. Specific data to be collected is identified in [Section 2.1.2.2 Data Collection](#) (as applicable), supplemented as follows:

**A. User Questionnaire:** An ARF-specific questionnaire shall be completed by users ([Exhibit 2.2](#)).

**B. Animal Census:** Quantity and species of resident animal colonies and their caging requirements are primary factors affecting facility design. Caging may be fixed or mobile, static or ventilated. Cage size and type are governed by *The Guide* as well as specific research protocols. Laminar flow containment equipment may be required for change-out and animal transfer.

**C. Animal Health Status:** Research animals are often purpose-bred and certified to be free of specific pathogens that can be transmitted to other animals or affect research outcomes. Specific-pathogen free (SPF) animals require special handling procedures to ensure that their health status is not compromised. SPF animals may also need to be housed in barrier facilities separated from conventional, non-SPF animals.

**D. Equipment:** Animal facilities equipment typically includes caging, cage sanitation and decontamination equipment, procedure room equipment including BSCs, cage change stations, treatment tables and lights, surgical equipment, etc. An equipment schedule shall be used to collect the data, supplemented with manufacturer data sheets that identify variability in size, service clearances, utility demands, heat output, etc.

**E. Standard Operating Procedures (SOPs):** Facility design and operating procedures are interdependent, and incomplete understanding of SOPs often results in functional design deficiencies. Every effort shall be made during the programming phase to document SOPs that have a direct effect on design. At a minimum, these include:

1. Use of PPE
2. Entry and exiting procedures for different zones within the facility

3. Cage handling and sanitation procedures and frequency
4. Decontamination procedures (waste, space, caging, animal carcasses, and material)
5. Security protocols
6. Feed, bedding, and animal drinking water use, storage, and disposal
7. Animal intake and quarantine procedures
8. Emergency management procedures and hazard mitigation
9. Maintenance and repair procedures
10. Emergency preparedness procedures

### 2.3.1.3 Documentation

Comply with [Section 2.1.2.3 Documentation](#). Additionally, record SOPs in either narrative or flow chart format.

## 2.3.2 Animal Research Facility Planning

### 2.3.2.1 Location Considerations

Several factors should be considered in locating the ARF within a research building.

1. A direct, dedicated path to loading docks is required.
2. Windows shall not to be used in most holding and procedure rooms. Windows may be appropriate for NHPs and some other large animals, and may be appropriate in procedure rooms and other support rooms based on the program and in consultation with the program personnel.
3. Holding rooms should be isolated from noise and vibration sources.
4. Cage wash equipment produces noise, vibration, and humidity, and requires pits and drains.

5. Environmental stability including flooding and other risks should be reviewed and addressed appropriately.
6. Separation of HVAC systems. Pressurization and airflow must be independent of, and not impacted by, other building systems.

Other factors that may affect facility location include:

1. Investigator access
2. Animal transport
3. Physical security and facility hardening
4. Environmental issues (odors, vibration, noise)
5. Utility-maintenance access
6. Material handling

There may also be risk factors such as natural hazard mitigation and biosafety that should be considered to establish acceptable locations for the ARF within a building.

### 2.3.2.2 Space Requirements

Calculating optimal size for an ARF is based on animal holding capacity and procedure space requirements. Procedure space can include surgery, imaging, behavioral testing, and other animal manipulation rooms. Holding and procedure functions typically occupy approximately 50% of the overall net usable area for facilities operating at ABSL-2. Other functions will include sanitation (cage wash, decontamination), animal health (treatment, surgery, quarantine), personnel support (office, break room), and logistics (loading dock, receiving, storage). [Figure 2.3.2.2](#) illustrates proportional net space allocation for typical facilities.

**Figure 2.3.2.2 Proportional net space allocation for typical facilities**

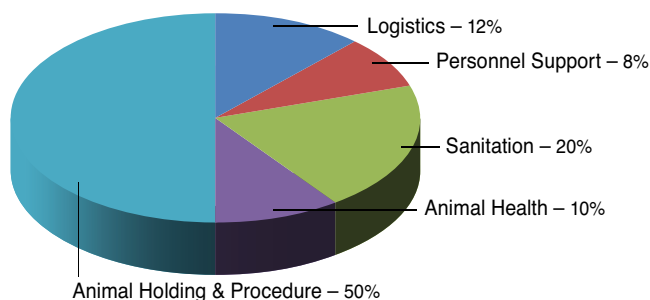

This rule of thumb does not take into account special functions that may be incorporated such as advanced animal imaging, research specific procedure rooms, isolation suites for barrier colonies, biocontainment suites, etc. Factors that affect animal holding and procedure space requirements are listed in [Section 2.4.5 Design Considerations](#).

### 2.3.2.3 Contamination Control

Layout, engineering controls, and SOPs play a coordinated role in controlling the spread of infection among research animals housed in a facility. Animals, materials, and personnel can be characterized as “clean” or “dirty,” referring to their potential for transmitting diseases to resident animals. For example, animals from an unapproved source are considered “dirty” until they have been evaluated for health status during a quarantine period. Feed, bedding, and other incoming materials may also be considered “dirty” until decontaminated or sterilized. Animal bedding and caging that is soiled from use is considered “dirty” until it has been sanitized. Staff must also follow designated SOPs for gowning, hand wash, and circulating through the facility to minimize opportunities for cross-contamination.

Areas of the animal facility that are prone to contamination and need to be protected by contamination control SOPs are located within a contamination control barrier. Typically, these areas comprise animal holding and procedure rooms as well as animal support areas where caging is cleaned and decontaminated and “clean” expendable materials used within the facility are stored. The barrier is defined as the assembly of partitions, floors, and ceilings that enclose this area. Personnel entering into the barrier must gown per established SOPs. Material entering the barrier must be decontaminated. Anterooms typically afford access in and out of the barrier so that directional airflow can be maintained and gowning SOPs facilitated. Circulation of animals, materials, personnel, and waste within the barrier shall be configured to move from cleaner towards dirtier areas of the facility to minimize opportunity for cross-contamination. To maximize infection/outbreak control, a compartmentalized design approach should be evaluated with the stakeholders during predesign.

In some facilities, additional suites are located within the overall ARF barrier which require enhanced protection or containment. The perimeters of these suites are

also protected by barrier-type enclosures and subject to additional SOPs and directional airflow.

### 2.3.2.4 Functional Relationships

ARF facilities should be organized by zones of compatible functions to enhance contamination control and facilitates workflow. Circulation pathways between zones should be designed to facilitate directional movement of “clean” and “dirty” materials, animals, caging, waste, and personnel. The HVAC design must also be coordinated with the zoned planning approach to facilitate directional airflow from cleaner to dirtier areas. [Figure 2.3.2.4](#) illustrates the relationship among typical animal facility zones.

The PO and the programmer shall work with the facility representatives to prepare functional and adjacencies flow charts that will facilitate the design process. Adjacencies shall be planned to facilitate operational procedures, enhance contamination control, and maintain zonal relationships. Proper arrangement of critical adjacencies enhances the process of animal-based science, improves the quality of life of the animals, and facilitates animal-caretaking SOPs. Appropriate adjacency planning also helps isolate noise and vibrations, economize circulation routes, and simplify facility operations.

**A. Personnel Zone:** The personnel zone includes an administrative office area serving the facility manager, administrative staff, and technician cubicles where staff can wear street clothes. It may also include a veterinarian office and conference/training room. This area should be located to serve as a “gateway” into the ARF, so that incoming staff, visitors, and investigators can be received or observed prior to entering secure areas of the facility. A break room is required for facility staff to use for consumption of food outside the barrier. The personnel zone is categorized as “dirty” because there is limited control of potential contaminants in this area. Toilet/locker/gowning areas serve as a transition into the barrier, and should be located between the administrative area and the facility barrier. Separate toilet/shower/locker facilities are required for men and women, except in very small facilities. Gowning vestibules for donning PPE may be separate from the toilet/locker/shower room, and must be provided with sufficient floor area for PPE storage racks and disposal bins so as not to obstruct required circulation and egress paths. In some cases, it may be

appropriate to locate a staff write-up area and break facility within the barrier for caretaker convenience but this requires special SOPs and must be approved by the veterinarian and facility manager.

**B. Vivarium Zone:** The vivarium zone includes areas for housing, caring for and manipulating animals, and for cage wash and other functions involving contact with animals. The vivarium zone is entirely within the barrier.

1. **Animal Holding and Procedure:** Animal holding and procedure are clean functions located within the barrier except for the quarantine area. Refer to [Section 2.3.4.4 Animal Intake and Quarantine](#). Personnel entering this area must be gowned using PPE established by the SOP. Material entering this area must be decontaminated per SOPs. During pre-design, the means and methods of material decontamination shall be determined with the stakeholders. Clean caging enters this area after sanitation in the cage wash area through a ‘clean’ pathway. Ideally, soiled caging is returned to the cage wash area via a separate ‘soiled’ pathway. Alternately, if the size or configuration of the facility will not allow separate clean and soiled pathways, caging may be moved along a single path utilizing a movement/timing pattern that minimizes cross-contamination between clean and soiled items. In large animal facilities, caging is often cleaned in place, however clean-to-soiled circulation patterns for transport of materials and waste must be established. Animal holding and procedure spaces are often in close proximity so that animals do not require excessive transport.

Procedure space may be general, shared rooms designed for generic procedures or highly specialized space customized for specific uses. In some cases, the program may require dedicated procedure rooms interconnected with the holding rooms they serve. Specialty procedure functions may include surgical rooms or suites, behavioral suites, animal imaging rooms, irradiation rooms, necropsy/perfusion, and other purpose-built areas. The number of required procedure rooms varies in accordance with species, equipment needs, and animal transport

restrictions; however, sufficient procedure space should be provided to ensure flexibility for both current and future research initiatives. Additional flexibility can be provided by designing procedure rooms that can function as holding rooms as needed.

2. **Cage Wash:** The primary activity within the Cage wash is cage processing, including cleaning and decontamination of caging and caging accessories, soiled bedding removal, and preparing caging for return to animal holding rooms. Many of these activities occur in the cage wash area, which shall be divided with a dirty side for incoming soiled caging and a clean side for caging that has passed through sanitation equipment. Facilities housing SPF animals may also require a sterile caging area adjacent to clean cage wash for caging setups that have been autoclaved. Other areas include feed and bedding storage, clean cage storage, and diet kitchen for large animal facilities that prepare fresh feed. Soiled caging and waste shall be routed along separate pathways from clean material

and caging to the greatest extent possible. If separate clean and dirty circulation cannot be fully achieved due to space or other limitations, a single corridor may be utilized with one-way circulation or time-separated clean and dirty use. Cage processing SOPs, including processing procedures and frequency, must be confirmed by veterinary and caretaker staff.

3. **Other Functions:** Other vivarium zone functions may include quarantine, rederivation, necropsy/perfusion, pathology, carcass storage, and other functions related to bringing animals from unknown sources into the barrier or reintroducing animals after they have been removed from the barrier. The location of quarantine functions outside of but immediately adjacent to the barrier should be considered. Methodology for admittance from quarantine into the barrier shall be established during the pre-design phase. Cage decontamination and transport from quarantine areas should be managed to maintain contamination control.

**Figure 2.3.2.4 Typical relational diagram of an animal research facility**

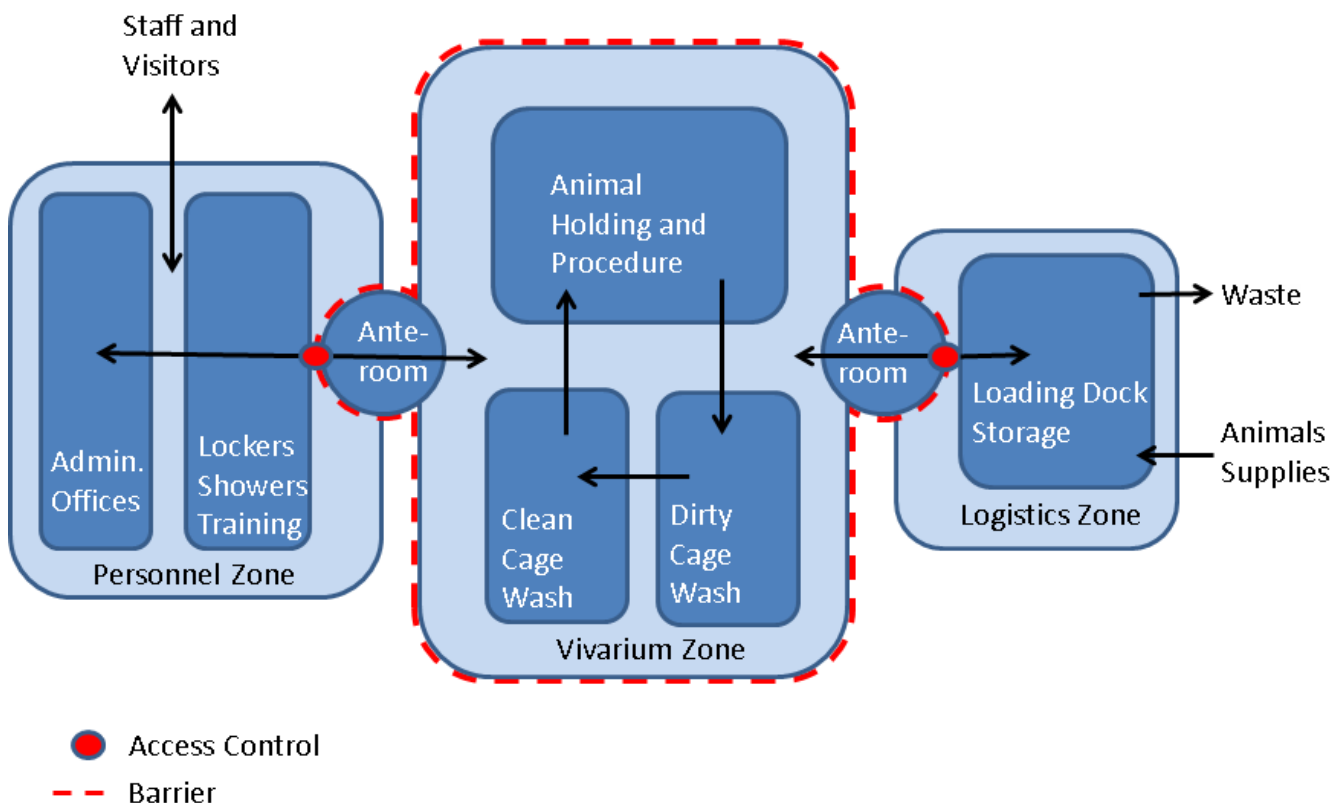



**C. Logistics Zone:** The logistics zone includes the loading dock, receiving area and vertical transport from the loading dock to the animal facility, medical pathological waste (MPW) storage freezers or cold room, and storage space for cage wash detergents, disinfectants, and other material. In larger facilities, automated bedding dispensing and waste-soiled-bedding removal equipment may also require space allocation. ARF areas associated with the loading dock are considered to be an extension of the ARF and shall be separated from general building logistical areas to the greatest extent possible. Ideally, loading docks should provide covered, sheltered receiving areas and they should connect directly to the ARF. When direct connection is not possible, a dedicated pathway for transport of animals, materials, and waste shall be defined. The pathway shall include dedicated elevators with controlled access if there is a vertical component. They shall be designed to promote proper sanitation and resist pest infestation. The loading dock area accessing the dumpster and waste disposal operations should be separated from the animal and material receiving area. Large animal facility truck bays should be configured to allow vehicles to enter a sight-protected, sheltered off-loading area, or otherwise dock to the receiving area. The pathway between receiving area and the barrier shall include a vestibule or anteroom for decontamination of incoming materials. Finishes and detailing shall facilitate sanitation and pest management practices.

### 2.3.2.5 Circulation

Circulation pathways are critical for facilitating operations and enhancing contamination control within the animal research facility. Planning of circulation focuses on the movement of personnel, cages, racks, materials, and waste through the facility. During the planning phase, the design team must work with the facility manager and veterinarian to determine the extent to which the corridor system and the SOPs governing time and direction of movement can accommodate clean and dirty circulation. Personnel, equipment, and supplies shall move from areas of least contamination to areas of greater contamination. Movement of personnel, equipment, and supplies shall be planned to minimize the potential for contamination of cleaner areas. Consideration shall be given to provision of space for staging clean and soiled caging and materials as well as space for personnel gowning and gown removal.

Movement of sterilized materials into barrier suites must also be considered. Natural light without direct views into the facility and clear directional signage can enhance circulation function.

**A. Corridor Width:** Corridor width shall be dependent on the flow of traffic and cage-staging requirements within the animal facility. *The Guide* recommends a corridor width of 1.8–2.4 m (6–8 ft.). Two animal cage racks or pieces of the largest mobile equipment must be able to pass each other without restriction in the corridor. Minimum clear corridor width of 2.1 m (7 ft.) is recommended for NIH facilities provided that this allows for two-way cage passage clear of wall protection rails (typically protruding 76 mm [3 in.] from each wall). Sufficient storage shall be provided within the facility so that caging and equipment does not have to be stored in the corridors. Marshaling alcoves for racks and carts shall be provided in congested areas so that corridors are not obstructed by equipment. Typically, 10% of the caging census shall be able to be accommodated in marshaling areas.

**B. Corridor Height:** Minimum corridor height shall be determined by the height of the largest equipment moved through the corridor, including cage racks. Height determination shall include items protruding from the ceiling, and ventilation and other equipment on the racks. Height shall factor in all above ceiling installation requirements, including service and access.

**C. Vertical Transportation:** In multilevel facilities, dedicated clean and dirty animal elevators are required. The elevator for transporting clean material shall be located near the clean side of the cage wash area, while the elevator used for soiled material shall be in close proximity to the soiled side of the cage wash area. Sufficient space shall be provided for marshaling and turning radii. Elevators within the ARF shall be buffered with a vestibule to prevent airflow/pressurization control issues. Refer to [Section 4.7 Vertical Transportation](#) and [Section 2.4.5.8 Vertical Transportation](#) for additional ARF elevator requirements.

### 2.3.2.6 Workplace Enhancement

ARFs are staffed with highly trained and educated personnel who often spend a great deal of time within a highly technical workplace. Maintenance of a safe, ergonomic, and aesthetically pleasing work environment is essential but often overlooked.

**A. Functional Zoning:** Personnel office areas must be separated from animal holding, procedure and support areas. Individual offices may be adjacent to holding or procedure rooms if required by program personnel. ARF equipment that creates excessive noise, heat, or vibration should also be buffered from normally occupied areas.

**B. Personnel Support:** A break room equipped with a kitchenette and tables shall be provided where staff can eat, drink, and interact outside of the barrier. Break rooms often double as conference/training rooms. Lockers shall be provided for ARF staff to store street clothing and personal items. Cubicle lockers may also be considered for investigators using the facility. Showers are also required in any facility that includes cage washing, and as stipulated by the SOPs.

**C. Natural Lighting:** Natural lighting and exterior views should be provided in office areas, break rooms, and other areas normally occupied outside of the barrier to the greatest extent possible. Natural lighting shall not be provided within holding and procedure areas unless specifically approved by the facility manager, veterinarian, and DPSM. Corridors and ARF support functions within the barrier may benefit from natural light in situations approved by program personnel.

### 2.3.2.7 Flexibility

Animal research facilities require flexibility to meet evolving research needs. Flexibility is also needed to incorporate changing technologies and scientific procedures. The following planning concepts can maximize flexibility:

**A. Generic Design:** The animal facility shall be flexible and adaptable to accommodate changes without having to make major changes to the facility. Holding rooms should be designed to hold multiple species over time. Individually planned or customized spaces are to be avoided. Animal holding and procedure rooms shall be designed to allow for interchangeability.

**B. Modularity:** Significant portions of animal facilities comprising holding and procedure areas can be organized in a modular pattern that supports a variety of caging types and layouts. Modularity shall extend to services and utilities.

**C. Furnishing Systems:** Benches and caseworks shall be flexible, and where practical, movable to allow for reconfiguration without major renovation. Modular systems shall be utilized that permit interchangeability of components. Consideration of mobile and/or wall-mounted casework and furnishing systems shall be taken into account during the pre-design phase.

**D. Utility Flexibility:** Components of the utility service and distribution systems that require routine maintenance should be accessible without requiring entry into the barrier. Modular distribution modes shall allow individual areas to be shut down without major disruption to adjacent areas.

**E. Expansion:** Planning analysis shall include consideration for future expansion of the animal facility to minimize disruption of the facility.

### 2.3.2.8 Utility Systems

Utilities and services serving animal research facilities shall be designed to (a) maintain stable environments, (b) be flexible to accommodate changing demands, (c) have redundancy to ensure dependability, and (d) be accessible for maintenance without disrupting operations.

**A. Maintenance Accessibility:** Utility mains and components requiring service should be located in areas that allow for access without entry into the barrier to the maximum extent practicable. Branch services shall be extended to individual spaces on a modular basis so that individual rooms can be isolated with minimal disruption to adjacent spaces.

There are numerous design strategies that facilitate maintenance accessibility including provision of an interstitial floor above the animal facility, utility corridors, adjacent, ancillary mechanical rooms, etc. Some allow for near complete access to utility system components without entry into the barrier. Others may limit maintenance access to less sensitive areas of the animal facility such as corridors. The selected approach shall consider tolerance of the specific program to maintenance activities and life cycle costs. See [Figure 2.3.2.8](#) for utility distribution strategies.

**B. Redundancy:** All critical utilities and services serving animal facilities shall be designed with redundant capability to ensure continuous operation during equipment

Figure 2.3.2.8 Utility distribution strategies

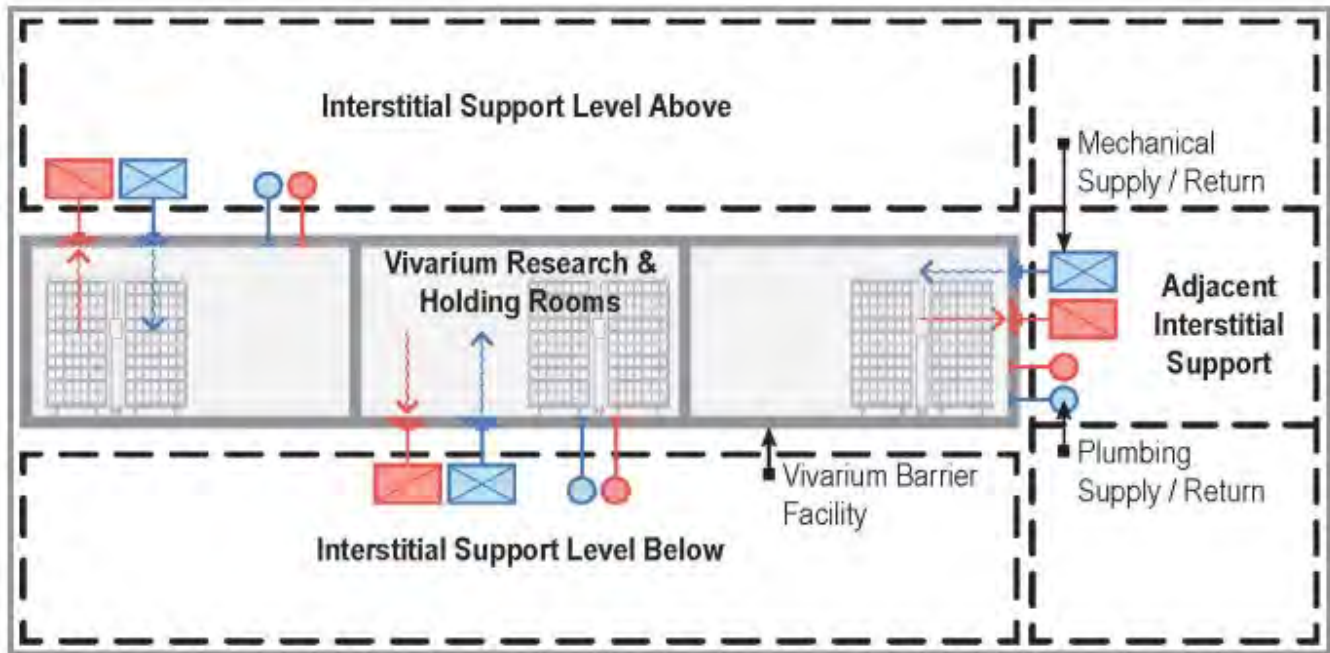

failure, power outages, and maintenance outages. The degree to which the facility must remain operational shall be established by the planning team during the programming phase.

At a minimum, all areas of the facility that house and support animals shall be capable of ongoing operation.

**C. Spare Capacity:** Reserve capacity shall be designed into building utility systems including vertical shafts to accommodate future growth.

**D. Segregated Systems:** Systems serving the ARF shall be appropriately isolated from non-ARF building systems.

**E. Directional Airflow:** The HVAC system shall provide directional airflow within the facility as required for pressurization and containment.

**F. Fire Notification:** Provide fire notification system in accordance with [Section 9.3.1.2 Notification Signals](#).

**G. Leak and Flood Prevention:** Floors of mechanical rooms and interstitial levels shall be designed to prevent leaks. Penetrations through the floor shall be protected by raised curbs or sleeves or otherwise configured to contain water and prevent leaks.

## 2.3.3 Biological Risk Assessment and Biosafety Level Criteria

Refer to [Section 2.1.3.7 Occupational Health and Safety](#) and [Section 1.15.6 Risk Assessment, Systems Failure & Disaster Mitigation](#). All animal facilities designed for the NIH shall be designed to ABSL-2 standards as a minimum in accordance with the latest edition of the BMBL.

## 2.3.4 Design Considerations

### 2.3.4.1 Animal Holding Rooms

There are several factors affecting animal holding room design:

**A. Holding Room Population:** The size of a holding room is determined by the species, number of cages or cage racks, and accessory equipment in that room. Larger rooms may be more efficient in terms of SF/cage; however, they increase the risk of infection of larger numbers of animals in the event of infection outbreak and may also require multiple studies to be conducted within one space. There are ergonomic considerations as well, including the number of cages that can be

reasonably managed by a single caretaker who may need to regown when entering each holding room, and space clearances required to safely perform caretaking activities and allow for future flexibility.

**B. Caging Types:** *The Guide* provides species specific data on minimum floor area and volumetric requirements for caging. Caging may be fixed for larger species, or freestanding racks housing multiple cages. Sufficient clearance must be provided to care for and observe the animals, move carts and equipment around the room, and egress from the room. Lighting shall account for rack type and spacing and shall provide appropriate lighting levels. Space is required for feed storage bins, waste container, cage change equipment, and hand wash sinks. If wall protection rails are provided they must be accounted for in space calculations. Utility systems must be designed for the caging system used to provide the required power and exhaust connections.

**C. Species Separation:** Different species often cannot be housed within the same holding room due to environmental requirements or other incompatibilities. Separate holding rooms and separation of holding rooms may be required.

**D. Barrier Suites:** SPF animal holding rooms should be located within suites that are isolated from conventional animal populations. When required by the SOP, these suites should be separated by anterooms. Dedicated autoclaves and other support equipment may be required for SPF suites.

**E. Noise:** Many animal species are very sensitive to noise. Background noise shall be minimized and sudden variable noise producing elements, such as fire alarms, must be mitigated through the use of strobes or voice systems. Species that generate noise should be segregated from noise sensitive animal populations. It is important to consider electronic devices and equipment such as occupancy sensors that generate sound at frequencies undetectable to humans.

**F. Vibration:** Holding and test rooms for species sensitive to vibration shall be located away from cage wash, mechanical rooms, elevator shafts, and other vibration sources. Vibration requirements vary by species and size of animal. Maximum tolerances shall be established with the veterinarian during the predesign phase for each area in the ARF. Vibration is also a concern for imaging equipment and other sensitive instrumentation.

Vibration studies shall be performed to determine how best to achieve required vibration performance.

**G. Floor Drains:** Small animal holding rooms typically do not require in-place cage cleaning and should not have drains and sloped floors which can be operational and maintenance nuisances. Holding rooms which require in-place cleaning may require hose stations, trench drains, and sloped floors. Capped floor drains may be considered for flexible and multi-species holding rooms. Requirements shall be confirmed with program personnel.

### 2.3.4.2 Cage Wash Areas

Cage wash areas shall be adequately isolated from animal holding and administrative support areas to mitigate the high levels of heat, humidity, noise, and vibration produced by cage wash equipment. Design of cage wash area HVAC systems must consider the heat and humidity generated by cage wash equipment so that an acceptable working environment is achieved for cage wash technicians. Clean and dirty sides of the cage wash area, which are two of the cleanest and dirtiest areas of the ARF, are separated by a contamination control barrier. Cage wash equipment that may include rack washers, tunnel washer, soiled bedding disposal unit, sterilizers, etc., should be configured for dirty-to-clean pass through operation (see [Figure 2.3.4.2](#)). When caging and materials are autoclaved for use in SPF areas, a second pass through sterilizer may be required between the clean cage wash and sterile cage storage areas. The clean cage wash area equipment may include a bedding dispenser and bottle filler.

**A. Cage Wash Sizing:** Factors that must be typically considered for sizing the cage wash areas are as follows:

#### Dirty Cage Wash

1. Equipment space including service and working clearances
2. Marshaling space for racks and cages to be washed
3. Prewash/soaking area for hosing or spray down of racks and caging prior to cleaning
4. Area for flushing animal drinking water manifolds when required



5. Area for queuing waste
6. Area for loading carriages and component racks used in washers and autoclaves
7. Hand wash area and commercial pot sink
8. Hose Station
9. Descaling pit
10. Drains
11. Emergency shower and eyewash

**Clean Cage Wash**

1. Area for wet caging to drip-dry, typically in front of rack washers
2. Working space for preparing cages
3. Area for unloading carriages and component racks used in washers and autoclaves
4. Queuing area for stacking clean caging and caging components

5. Bottle filling area
6. Space for clean cage marshaling or storage
7. Hose station
8. Compressed air system for clearing animal drinking water lines, when required
9. Clean cage marshaling
10. Emergency shower and eyewash

**B. Cage Wash Equipment:** Throughput calculations shall be provided based on user-provided data and SOPs on the animal species, census, caging types, cage change frequency, animal drinking water modes, operational schedule, staffing, redundancy requirements, etc., to determine the type, size, and quantity of equipment required for cage sanitation and decontamination. Calculations shall be included with planning deliverables. Equipment analysis for larger facilities shall include evaluation of the cost-effectiveness of automated systems for waste removal, cage handling, and bedding dispensing.

**Figure 2.3.4.2 Typical cage wash area relational diagram**

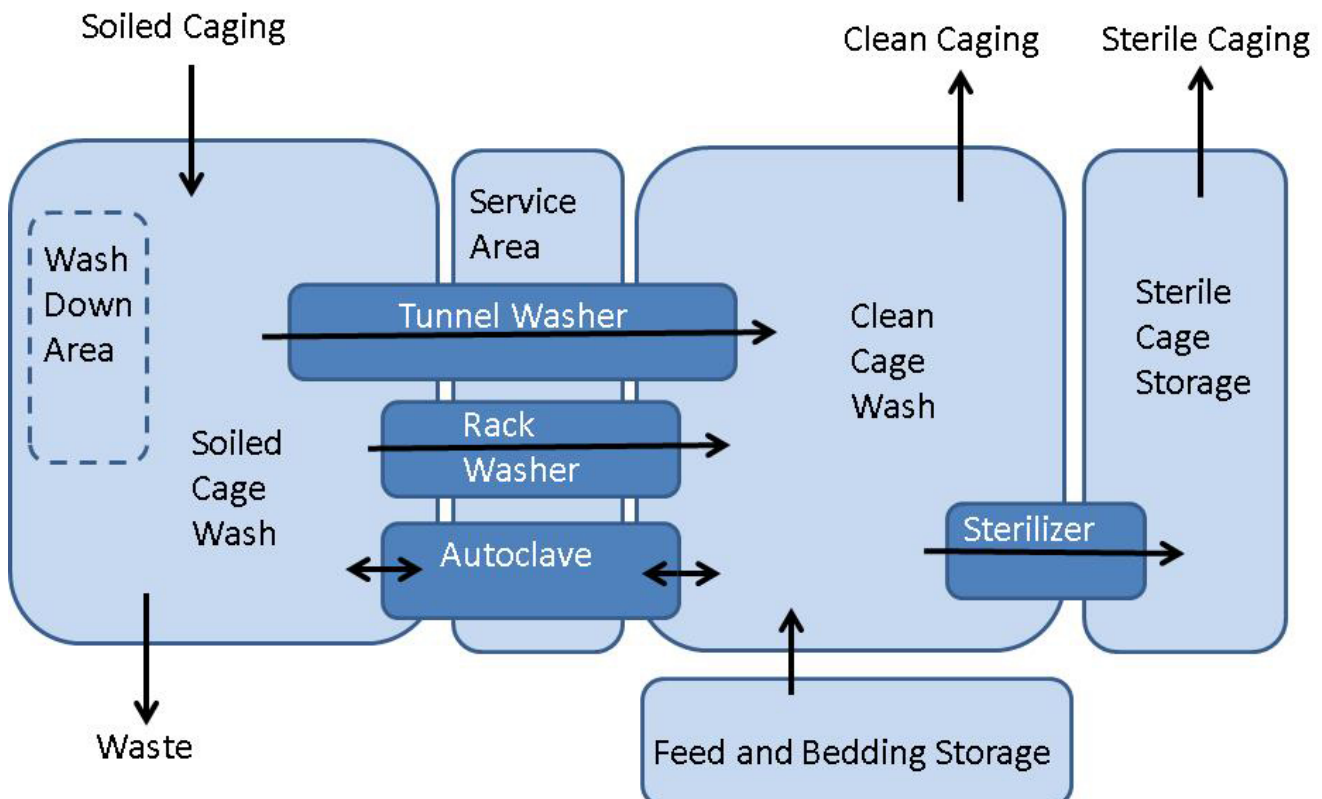

### 2.3.4.3 Storage

The following storage areas are required:

**A. Feed Storage:** Feed type is species dependent, and may include both commercial bagged feed and prepared fresh food. Bagged feed often requires a cold room to maintain product quality. The volume of feed that must be stored is based on the projected consumption rate and frequency of delivery. Typically, a minimum of two week supply per species is stored on-site in a dedicated room located near the clean cage wash area; however, more may be required for emergency contingency. Fresh feed may be required for large animal facilities, and typically requires both refrigerated storage and work area for preparation. The requirements for receiving, preparation, and storage of animal feed shall be determined by program personnel.

**B. Bedding Storage:** Bedding type is species dependent, but must also be compatible with caging type and waste disposal methodology. The volume of bedding storage is based on the projected consumption rate and frequency of delivery. Typically, a minimum of two week supply is stored on-site. Bulk, bagged bedding is stored near the clean cage wash area. Large facilities may use automated systems that include hoppers located near the loading dock.

**C. Cage Storage:** The size of room(s) required for the storage of clean caging and caging components is based on SOPs for the frequency of cage cleaning and the percentage of cages that must be cleaned on a daily basis. Typically, this is 10–20% of each caging type. Clean cage storage is typically located within or adjacent to the clean cage wash area. A separate area may be required for storage of sterilized caging and material in SPF facilities.

**D. Soiled Cage Marshaling:** Space shall be provided in or adjacent to the dirty cage wash area for temporary queuing of soiled caging awaiting sanitation. Size of this portion of the facility shall be determined by the throughput calculations outlined above. Soiled cages must not be stored in corridors.

**E. Supply Storage:** Additional storage space is required for supplies, PPE, clean laundry, and other items. The location and size of this area shall be calculated with program personnel.

**F. Bulk Detergent Storage:** Space is typically required for storage of bulk detergents and disinfectants. Where possible, bulk detergent should be stored near the loading dock or other area outside of the barrier to facilitate resupply, and pumped to the point of use. The size and number of tanks required for detergent storage is a function of delivery interval and types used, which must be determined by the program.

### 2.3.4.4 Animal Intake and Quarantine

Intake SOPs typically require animals to be transferred into facility standard caging and quarantined prior to assimilation into holding rooms. Intake and quarantine is typically required for all animals arriving from outside sources, and may be required for animals returning from outside the general vivarium. This activity should be located at the barrier perimeter and segregated from clean animal populations so that potentially contaminated animals are not transported through clean areas of the facility. Animal transfer typically requires a BSC or laminar flow change cabinet for handling micro-isolator caging and SPF animals. A pass through configuration or transfer box facilitates this procedure. Quarantine holding rooms shall comply with the same criteria as other holding rooms. SOPs for decontaminating quarantine caging prior to transport through interior barrier corridors must be accommodated by the design.

### 2.3.4.5 Necropsy

A necropsy area may be required, particularly for large animal holding facilities. The necropsy room is often the most negatively pressurized room in the ARF and airflow direction should always be into the necropsy room. This room is considered to be “dirty” and should be located at the barrier perimeter, or outside of the barrier along the waste removal pathway. Space requirements must be determined by equipment and furnishing needs as well as working space for personnel performing autopsies and tissue harvesting. Animal carcasses are considered to be medical pathological waste, and require a designated cold storage area, often adjacent to the loading dock waste area. Both refrigerator and freezer storage are required.

### 2.3.4.6 Surgical Suites

Large animal holding facilities and some small animal holding facilities require surgical suites. Large animal



surgical suites consist of one or more surgery rooms, a surgeon scrub area, animal prep room, surgical supply and work room, and recovery area. Depending on SOPs, recovery may occur within holding rooms or may require dedicated space. Small animal surgery may be performed within a typical procedure room or designated rooms equipped with exhausted surgical stations designed to contain biologic contaminants and scavenge anesthetic gases. Directional airflow is particularly critical in surgical suites to maintain aseptic conditions within the operating room. [Figure 2.3.4.6](#) illustrates a typical large animal surgery suite.

### 2.3.4.7 Insectaries

Insectaries are containment suites designed to house insects. Guidelines for insectary design can be found in [Appendix O.1 Insect Facilities](#) as well as provided

in the *Arthropod Containment Guidelines, Version 3.1* published by the American Committee of Medical Entomology and the American Society of Tropical Medicine. A risk assessment shall be conducted to determine the feasibility of co-locating an insectary with a mammalian holding facility. Functional components of insectaries typically include environmental chambers (walk-in or cabinet type) for insect holding and breeding, procedure room and anteroom to facilitate containment. Insectary suites shall be separated from other ARF areas by a vestibule with interlocking self-closing doors. Consideration should be given to vestibules at a low temperature to render insects inactive. Sufficient space shall be provided for procedures involving live insects to be performed within the suite, thereby minimizing the need for transport of live insects. See [Section 2.4.5.11 Insectaries](#).

**Figure 2.3.4.6 Relational diagram of a surgical suite in an animal research facility**

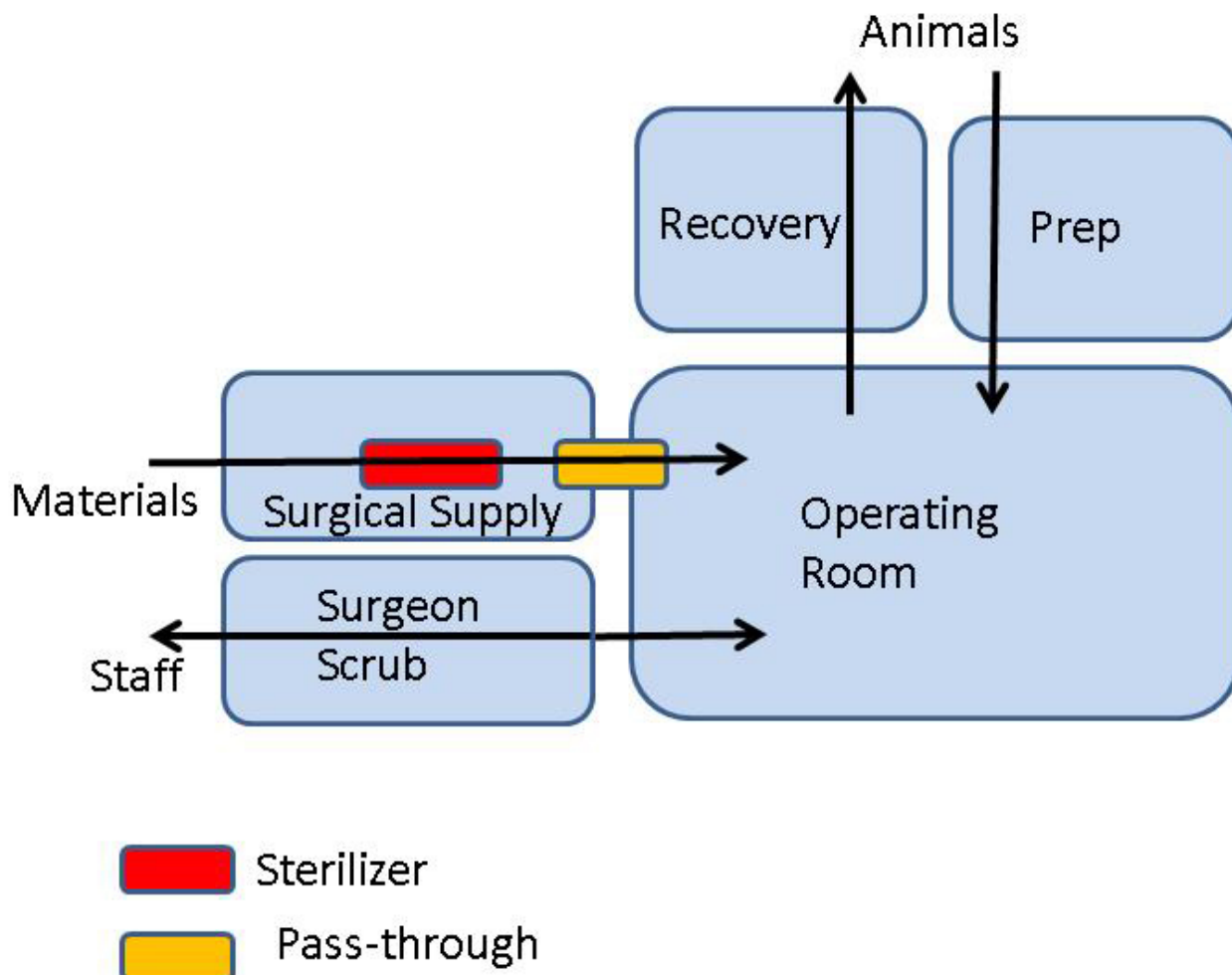

### 2.3.4.8 Aquatics

Aquatic holding rooms require special planning to support their unique environmental requirements and engineering systems. They are wet areas with specialized tanks and racks which generate humidity and require water delivery, drainage and other special systems. Environmental criteria differ depending on species housed and aquatic water system used and may include specialized lighting, temperature, humidity and other systems, which must be designed in consultation with program personnel. Aquatic holding racks require water filtration and treatment systems that may be self-contained or require dedicated equipment space. It is important to note that the aquatic water system forms the animal microenvironment and must be specified to meet research and animal husbandry parameters for biological filtration, temperature, flow rate, purity, pH, particulates, salinity, and oxygenation. Aquatic support areas may include procedure rooms, brine shrimp hatcheries, water quality labs, and wash areas that are separated from other cage wash areas to prevent detergents and disinfectants from contaminating the aquaria. Infection control is primarily achieved through filtration and decontamination features of the water system. Consideration should be given to compartmentalization of aquatic population by utilizing multiple segregated water loops or one-pass systems. Some aquatic water systems utilize gravity drainage that requires lower level water filtration systems.

In designing an aquatics facility, the following shall be considered and provided per program requirements:

- A. Nursery:** Space for tanks and support equipment for the nursery functions
- B. Procedure:** Multi-function support area in or near holding rooms
- C. Space for Preparation of Food:** Space shall be allocated adjacent to the water tank holding rooms for mechanical system components, live food production, supplies, and additional procedure areas. Provisions may also be required for the preparation and storage of dry food.
- D. Storage:** Equipment storage and possibly equipment repair and modification
- E. Quarantine Area:** A quarantine area may be required for incoming animals. The location of the water pumps

and recirculation piping shall have a major effect on the design of this area, including vibration and lighting considerations.

**F. Sink and Bench Space:** A sink and adequate bench space for procedures and staff activities per each module.

An aquatics facility may require easy access to a fume hood because of highly carcinogenic and teratogenic chemicals used.

### 2.3.4.9 Animal Imaging

Advanced imaging suites utilizing various modalities including magnetic resonance imaging (MRI), positron emission tomography (PET), computed tomography (CT), ultrasound, and bioluminescence are becoming increasingly critical for animal-based research. Facilities for animal imaging must typically meet criteria equivalent to similar facilities for humans, except that equipment size is often smaller. Imaging suites may be core facilities serving both resident animals as well as animals from other facilities. Imaging suites typically include imaging rooms, imaging support equipment rooms, animal prep, holding and procedure space, and space for equipment control consoles. Space size and configuration must comply with imaging equipment manufacturer field installation criteria and be accepted by manufacturer representatives. Spatial relationships must facilitate user-defined work flow and SOPs for animal handling. In locating animal imaging facilities, the following issues should be taken into consideration:

- A. Vibration Stability and Isolation:** Vibration stability and isolation from vibration sources are required to meet equipment operating criteria.
- B. Structural Capability:** Structural capability to accommodate equipment weight
- C. Isolation from Interference:** Consider isolation from sources of interference. For MRI, this may include separation and/or shielding from large moving ferrous metal objects (vehicles, elevators) that distort data output.
- D. Shielding:** Radiologic RF, EM, and other types of shielding may be required.
- E. Isolation for Personnel Safety:** Consider isolation for personnel safety. For MRI, areas within the 5-gauss magnetic field must be secured to exclude people.

**F. Pathways:** Pathway for delivery, installation and replacement of large, heavy equipment components

**G. Maintenance Access:** Equipment components that are not required to be within the same room as the animal should be located outside of the barrier to the greatest extent possible to facilitate maintenance access and control noise and heat.

**H. Animal Transport:** Transport of animals to and from the facility. If the facility serves as a core that images animals from outside sources, transport and handling of potentially “dirty” animals must also be considered.

#### 2.3.4.10 Behavioral Suites

Behavioral suites utilize specialized testing equipment that typically requires smaller isolated rooms that are buffered from their surroundings and free of unwanted stimuli. Behavioral suites shall be located remotely from sources of noise and vibration such as cage wash areas and large animal holding rooms. Criteria to limit noise transmission and acoustic noise within the behavioral spaces shall be established during predesign.

## 2.3.5 Plan and Program Deliverables

Refer to [Section 2.1.4 Predesign Deliverables](#) for pre-design deliverable requirements. Additions to this list are as follows:

**A. Flow Diagram:** Flow diagrams indicating proposed circulation of animals, staff, caging sanitation, waste, and materials based on SOPs listed in [2.3.1.2 Data Collection](#).

**B. Throughput Calculations:** Projects including sanitation or decontamination equipment shall include throughput calculations validating that the equipment is properly sized.

**C. Questionnaire:** Completed ARF Questionnaire ([Exhibit 2.2 Animal Research Facility Program Questionnaire](#)).

# Section 2.4

## Animal Research Facility Design

---

### Contents

**2.4.0 Introduction**

**2.4.1 Design Requirements**

**2.4.2 Modular Design**

**2.4.3 Materials and Finishes**

**2.4.4 ARF Security**

**2.4.5 Design Considerations**

**2.4.5.1 Animal Holding Rooms**

**2.4.5.2 Procedure Rooms**

**2.4.5.3 Receiving/Quarantine Rooms**

**2.4.5.4 Storage**

**2.4.5.5 Janitor's Closets**

**2.4.5.6 Cage Wash Area**

**2.4.5.7 Corridors**

**2.4.5.8 Vertical Transportation**

**2.4.5.9 Loading Docks**

**2.4.5.10 Surgical Suites**

**2.4.5.11 Insectaries**

**2.4.5.12 Aquatic Holding Rooms**

**2.4.5.13 Animal Imaging**

**2.4.5.14 Necropsy**

**2.4.5.15 Behavioral Suites**

**2.4.5.16 Administrative Areas**

**2.4.6 Utility Systems**

## 2.4.0 Introduction

In this section the requirements for the design phase of an animal research facility project are outlined. Refer to [Appendix F: Room Data Sheets](#) and discipline specific chapters for additional information. For general design parameters, reference [Section 2.2 Research Laboratory Design](#).

### 2.4.1 Design Requirements

Design of an animal research facility (ARF) must address organizational, operational, security, and infrastructure issues.

#### Organizational issues that affect the design include:

1. Functional zoning of primary components including administrative areas, animal holding and procedure areas, ARF support areas, logistical support areas, and building support areas
2. Interrelationship of functional components within each zone
3. Relationship of the ARF to other building functions
4. Blocking and stacking of program elements

#### Operational issues that affect the design include:

1. Circulation of visitors, staff, materials, animals and waste among different functional zones
2. Workflow
3. Standard operating procedures (SOPs) for personnel gowning, cage processing, and contamination control
4. Equipment throughput
5. Logistical support
6. Security
7. Occupational safety

#### Infrastructure issues that affect the design include:

1. Capacities, location, and size of primary utility systems
2. Utility and service distribution
3. Maintenance access including adequate clearances for maintenance activities and configuring systems to that maintenance activities can be performed without entering the ARF perimeter
4. Vibration and acoustical sources and locations

Conceptual design alternatives must address the proposed approach to each of these issues to confirm validity and allow for comparative analysis.

### 2.4.2 Modular Design

Animal facilities encompass a variety of fundamentally different space types that may not conform to modular design. Nevertheless, significant portions of the facility comprised of holding and procedure areas can be made to conform to a regular module. Because many facilities are located in laboratory buildings, the animal facility module must often be reconciled with the structural grid established for laboratory modules on other floors. The modular design and structural grid should work together to the greatest extent possible. The planning team shall develop alternatives for typical modular holding and procedure rooms illustrating possible caging and equipment layouts for multiple species. Alternatives shall illustrate all items present in the room, including a hand wash sink, carts, feed bins, animal change equipment, etc. When holding rooms are required to accommodate fixed or mobile large animal cages that require in-place cleaning, hose station, floor slopes, and drains shall also be shown. Alternative modules shall be evaluated based on flexibility, housing density, and ergonomics.

### 2.4.3 Materials and Finishes

The guidelines provided in this section apply to all areas of the animal facility except administrative offices.

**A. General Detailing:** Surfaces, joints, casework, equipment, exposed mechanical and electrical devices, and other elements within animal facilities shall be constructed of smooth, impervious, easily sanitized materials and configured without recessed areas and voids that are difficult to access for cleaning and pest control.

**B. Penetrations and Sealants:** All penetrations into and through partitions, floors, and ceilings shall be sealed to enhance sanitation. Piping, ductwork, electrical boxes, conduits, and other penetrating items shall be firmly anchored to resist movement that could damage seals. Seams between walls, floors, and ceilings, and between all dissimilar materials shall be fully sealed. The tops of hollow partitions shall be sealed to exclude pest infestation. Sealant at movement joints shall be applied after installation of high-performance finishes to resist cracking. Sealants shall comply with the [Appendix L: Sealant Table](#).

**C. Partitions:** Partitions shall provide suitable substrates for application of high-performance finishes, typically epoxy paint or fiberglass-reinforced polymer (FRP). Large animal holding facilities shall be constructed of masonry, seamless FRP panels, or other impact-, hose-spray-, and chemical-resistant systems. Special consideration for reinforcing wall finishes is required in rooms where walls form a portion of the animal pens. Small animal holding facilities may be constructed of abuse- and water-resistant gypsum wallboard provided that wall protection rails or fiberglass-reinforced coatings are used for protection, and rooms are not subject to hose-spray wash down.

**D. Wall Protection:** Corridors, cage wash areas, and other spaces that are subject to contact with mobile caging, racks, and equipment shall be protected by aluminum or stainless steel wall protection rails and corner guards. Appropriate wall protection type and location shall be agreed with the project stakeholders.

**E. Ceilings:** Ceilings shall be constructed of water-resistant and seamless material such as water-resistant gypsum wallboard, seamless FRP panels, cement plaster, or other durable, monolithic, water-resistant systems. Ceiling structures must be designed to resist

sagging and deflection due to room pressure gradients. Access panels, if required, shall be fully gasketed around the entire perimeter, and constructed of stainless steel. If access requirements warrant the use of a panelized system, a fully gasketed FRP suspended panel system may be used. The system shall be designed with hold-down clips that compress the gasket around the entire perimeter and allow for panel removal and reinstallation without damaging components.

**F. Floors:** Floors shall be monolithic with integral coved base (152 mm [6 in.] minimum height), chemical resistant, impervious to water, and capable of withstanding impacts and heavy wheeled traffic. Flooring finishes shall be extended wall-to-wall under equipment and casework systems. Floors in all areas equipped with hose stations shall be sloped to drains at 1% slope minimum. Floor slopes shall be coordinated with door sills to prevent uneven threshold conditions. Slopes greater than 1% should be considered in large animal holding areas to facilitate cleaning and prevent ponding. Floor slopes must not create unsafe conditions. Floor slopes shall be reviewed by DOHS and program personnel. Floors shall be skid resistant without excessive abrasiveness that damages mops and resists sanitation.

**G. Finishes:** All finishes shall be seamless, impervious, smooth, easily sanitized, and resistant to degradation from water, chemicals, disinfectants, and decontaminants used within the animal facility.

**H. Doors:** Doors that serve areas of cage and rack transport shall be a minimum of 1.1 m x 2.3 m (3ft. 6 in. x 7 ft. 6 in.). In large animal facilities, minimum door size shall be 1.2 m x 2.3 m (4 ft. x 7 ft. 6 in.). Door sizes shall be reviewed to ensure coordination with proposed caging systems. Doors shall be solid or solidly foam filled without voids and constructed of fully sealed FRP with stainless steel frames. Jamb guards shall be provided in doors that serve areas of cage transport. Doors serving high-use caging transport areas such as cage wash, cage storage, and selected corridors should be equipped with automatic openers to facilitate operations and reduce impact damage. Paddle- or proximity-type switches are often more practical than sensors as they limit incidental operation in busy areas. Animal holding room doors shall have tight-fitting sweeps to inhibit pests and contain escaped animals. Animal holding room doors shall be equipped with view windows to allow for observation without entry, and securable shutters or translucent



limited spectrum red film to obscure the view window and maintain diurnal lighting conditions.

**I. Casework:** Wall-mounted cantilevered counter tops or movable tables and mobile base cabinets shall be provided to enhance flexibility, sanitation, and pest control. Countertops and shelving shall be constructed of materials that are smooth, impervious to water, and resistant to degradation from harsh chemicals used for sanitation and decontamination such as epoxy, stainless steel, or phenolic-impregnated panels.

---

## 2.4.4 ARF Security

The security strategy shall safeguard research animals, staff, equipment, and data. A layered approach is required with increasingly restrictive levels. Coordinate security requirements with DPSM.

**A. First Level of Security:** At NIH owned or leased facilities, the first level of security may be the campus or site, which may be open to the public or have controlled access depending on the location.

**B. Second Level of Security:** The second level of security is the building perimeter. Access to the building must be controlled, including air intakes, utilities and other potential access points.

**C. Third Level of Security:** The third level of security is the animal research facility perimeter. Access to the administrative area is typically required for facility staff, maintenance personnel, vendors and visitors. The administrative area should function as a gatekeeper to other areas of the animal research facility. Deliveries may also go directly to the loading dock, which requires secure access.

**D. Fourth Level of Security:** The fourth level of security is into the animal facility barrier from the personnel support/administrative zone or the loading dock/logistics zone.

**E. Final Level of Security:** Finally, individual spaces within the barrier often require secure access. These typically consist of animal holding rooms, special use suites, hazardous areas (irradiator rooms, biocontainment zones, pharmacies, etc.) and areas housing specialized equipment.

**F. Additional Requirements:** Additional consideration should be provided for the security of controlled substances in appropriately locked cabinets and/or secured rooms (i.e., pharmacy).

---

## 2.4.5 Design Considerations

### 2.4.5.1 Animal Holding Rooms

**A. Caging and Equipment Coordination:** A minimum 914 mm (3 ft.) wide aisle shall be provided between racks or cages from the rear of the room for emergency egress; however, wider aisles may be necessary for cage change equipment, or to provide proper safety clearances when housing more dangerous species such as non-human primates. In large animal holding rooms, gated aisles can be used to create socialization and exercise areas. When double sided cage racks are used, sufficient space must be provided in secondary aisles between racks to ensure adequate lighting for caretakers to observe each cage; a 762 mm (2 ft. 6 in.) minimum is recommended.

High-density caging systems are available that eliminate aisle space between racks by utilizing carousel- or library-style caretaker access. Caging systems must be evaluated by the planning team on a case-by-case basis to ensure that the overall room ergonomics, environmental parameters, and species-specific habits are acceptable.

Freestanding cage racks are often mobile ventilated units with either self-contained blowers or manifolds designed for connection to the building HVAC system. The layout and requirements of ventilated racks must be coordinated with electrical and HVAC services. Ceiling-mounted exhaust drops shall be stainless steel. Electrical outlets provided for rack blowers shall be mounted above 2 m (6 ft. 8 in.), or in the ceiling. Both ventilated cage racks and static cage racks using micro-isolator caging typically require the use of laminar flow change stations to keep animals clean during cage change-out. Room layout must account for this equipment, which may be either fixed or mobile depending on the system employed.

**B. Lighting:** The lighting layout shall provide an appropriate level of illumination for animal observation and care, as determined by the veterinary staff. Lighting

fixtures shall be sealed to prevent vermin access. If surface-mounted lighting fixtures are used, they shall be sufficiently high to clear caging, including top-mounted rack motors. Fixtures in rooms equipped with hose stations shall be suitable for wet locations and direct hose spray. Finishes shall be compatible with sanitation and decontamination methods designated by the SOP. Discussions shall be held with the veterinarian and researchers regarding the required light spectrum. Specialty red lighting invisible to rodents may also be required to allow investigators to work during simulated night-time conditions.

Controllable diurnal lighting cycles are required in all animal holding rooms to simulate natural photoperiods. Intensity levels vary by species, but low ambient levels with timed overrides for a higher level during periods of caretaker and investigator activity are typical. Whenever possible, lighting shall be centrally controlled with the capability for individual programming for each room. If use of high-density caging is proposed, lighting design shall provide even light distribution to all cages. Some high-density caging are equipped with integral lighting systems.

**C. Environmental Monitoring and Control:** Animal rooms shall be equipped with individual temperature control. Depending on research requirements, individual or zoned humidity control may also be required. Centrally controlled systems are preferred. Monitoring at each room is required for temperature, humidity, lighting, and airflow.

**D. Plumbing:** All small animal holding rooms shall be equipped with hand wash sinks. Hands-free operation should be considered. Large animal rooms are not required to have a sink; however, a sink must be located nearby and wherever SOPs require gloves to be changed or removed. Large animal holding and water tank aquatic holding rooms shall be provided with drains. Drains in small animal holding rooms should be avoided; however, users should be consulted to verify if drains are desired for future flexibility. When drains are provided, consideration should be given to appropriate size of drain lines, and maintenance of traps, strainers, drain caps, flush systems, and floor slopes.

**E. Animal Drinking Water:** The type of animal drinking water system shall be determined during the project program phase (automatic, bottled, or pouched). If automated watering is not desired at the onset,

consideration should be given to possible future installation. Consideration should also be given to the quality of water required. Refer to [Section 12.2 Animal Drinking Water Systems](#).

### 2.4.5.2 Procedure Rooms

General-use procedure rooms should be designed using the same modular size, finishes, and general layout as animal holding rooms to allow for flexible conversion to animal holding. Consideration should be given to utilizing movable tables in lieu of fixed casework for procedure rooms to enhance flexibility.

The ratio of procedure rooms to small animal holding rooms is generally 1:2 or 1:3, but may be higher or lower depending on the program, the size of the holding rooms, and other factors. The ratio of procedure rooms for large animals is determined by the program and the facility.

Procedure rooms should be distributed so that at least one is within or adjacent to each holding area (such as a cluster of cubicles or a suite), for convenience and to minimize movement of animals. Consideration should be given to specialty small animal surgery rooms (with downdraft table, gases, anesthesia capture and other dedicated surgery equipment) in addition to procedure rooms.

### 2.4.5.3 Receiving/Quarantine Rooms

Receiving and quarantine rooms process and house animals into the barrier or reintroduce animals after they have been removed from the barrier. The location of quarantine functions outside of but immediately adjacent to the barrier should be considered. Methodology for admittance from quarantine into the barrier shall be established during the predesign phase. Cage decontamination and transport from quarantine areas should be managed to maintain contamination control.

### 2.4.5.4 Storage

Storage is required for hazardous materials (including chemicals, radiologic materials, and biologic material), cages, feed and bedding, equipment and miscellaneous supplies and materials. Dedicated storage rooms should be provided at strategic locations to ensure an efficient and adequate flow of materials in and out, without unnecessary accumulation or cross-contamination.

### 2.4.5.5 Janitor's Closets

Janitor's closets should be located at convenient locations along primary and secondary corridors. Janitor's closets should be large enough to contain the equipment and supplies necessary for the routine cleaning of the facility. Shelving, mop racks, water source, and a floor set mop sink shall be provided. Walls adjacent to the mop sink shall be water, chemical, and impact resistant.

### 2.4.5.6 Cage Wash Area

**A. Cage Processing:** Cage processing typically includes breakdown of caging components, soiled bedding disposal, cage and rack pretreatment, auto watering manifold flush, automated wash in tunnel and/or rack washers, drying, bedding dispensing, bottle filling, caging reassembly, and when required, sterilization of clean caging.

**B. Clean and Dirty Rooms:** Cage wash areas shall be subdivided into separate clean and dirty rooms to facilitate cage processing workflow and contamination control. See [Section 2.3 Animal Research Facility Predesign](#). Partitions surrounding and separating these areas shall be floor-to-deck, and there should not be any direct personnel access between the clean and dirty rooms. An interior window can provide visual connection, and a telephone or intercom can be provided for communication between rooms.

In larger facilities, consideration shall be given to a robotic cage washing equipment, supplemented with a conventional cage washing equipment for redundancy.

Cage wash room corridor doors shall be equipped with automatic operators to facilitate cage and rack transport. Eyewash and an emergency shower shall be provided in both the clean and dirty cage wash areas.

**C. Construction:** Cage wash area partitions and finishes shall be designed to withstand impact from cage racks, loaded carts, and direct hose spray. Electrical fixtures and all other elements and finishes shall be appropriate for wet locations. Masonry or FRP construction is recommended. Floors are often wet, and shall be slip resistant.

Cage wash and sterilization equipment floor pits, piping, and service components are difficult to sanitize and shall be enclosed within a partitioned service area or cabinet enclosures to the greatest extent possible.

Equipment service areas shall be adequately sized to comply with manufacturers' requirements for service clearances.

**D. Plumbing:** Cage wash rooms shall be equipped with hose stations and floor drains to facilitate sanitation procedures. Trench drains are recommended in larger facilities, and should be equipped with basket strainers to capture debris that could clog drainage systems. Wet areas shall be sloped to drains to prevent ponding. Oversized, acid-resistant waste piping is required to accommodate corrosive detergents, minimize clogs, and facilitate cleaning.

Water utilized for cage washers and autoclaves may require treatment for softening. Clean steam may also be required for autoclaves. When water treatment is required, space for treatment equipment shall be indicated.

**E. Cage Wash Equipment:** All cage wash equipment shall be installed in accordance with the manufacturer's requirements and recommendations. Minimum service clearances shall be indicated for fixed equipment. Clean and dirty side canopy hoods shall be provided for wash and sterilization equipment. Canopy hoods shall have gutters and piping to route condensate to drains. Soiled bedding waste disposal equipment shall contain odors and aerosols.

**F. Chemical Storage:** A chemical storage area shall be provided for placement of cage wash detergents drums and liquid disinfectants. Containers stored in this area shall be protected by secondary containment devices or curbs. Location of detergent pumping system and routing of detergent piping to the cage wash shall be shown.

**G. Cage Repair Shop:** A cage repair shop should be considered for large facilities or facilities with large animals. The shop should be located in proximity to animal holding and cage wash, and should have shop equipment and workbenches.

### 2.4.5.7 Corridors

All corridors within the animal facility except for those serving office areas outside of the barrier shall be designed in accordance with [Section 2.4.3 Materials and Finishes](#). Signage and graphics shall be provided to facilitate wayfinding. All wall-mounted items including fire extinguisher cabinets, animal-watering pressure-reducing stations, security hardware, etc., should be

recessed or protected to avoid impact damage. Where this is not possible, projected wall rails shall be provided to protect protruding items.

#### 2.4.5.8 Vertical Transportation

In multi story facilities dedicated elevators shall be provided for ARF use, with separate elevators dedicated for clean and dirty functions. Traffic patterns shall be established to separate the various traffic types in an efficient, logical, safe, and secure manner, while maintaining levels of aseptic control consistent with the requirements of the facility. Additional elevators may be required for freight/service, materials and personnel.

Elevator(s) for transporting “clean” material shall be located near the “clean” side of the cage wash area, while the elevator(s) used for “dirty” material shall be in close proximity to the “dirty” side of the cage wash area. The elevator sizes and locations must accommodate the volume and nature of materials to be handled. Elevators that shall be used for transport of animals and animal facility equipment must be constructed of highly durable and sanitizable materials. The elevator cab wall shall be stainless steel. The cab floor material must be of similar material as the floor in the animal facility. The elevator car interior shall have wall protection at appropriate heights and depth for the typical racks and carts that shall be used in the facility. Elevator doors must be of sufficient height to accommodate the tallest racks that shall be used in the facility. Consideration shall be given to an elevator cab width that can accommodate at least two racks side by side. Adequately sized vestibules shall be required outside of elevator openings to maintain pressure differentials and contain errant odor.

Unless other alternatives are available, at least one elevator shall have the capacity to handle extremely heavy loads (e.g., irradiators, MRI). There shall be adequate redundancy in the number of elevators to handle freight, staff, and animals in the case of an equipment breakdown or regular service. This can be accomplished by providing for flow patterns between “clean and dirty” elevators or other alternatives so that they can serve as backups to each other. Guillotine type (vertical bi-parting) hoist way doors shall not be used. Penetrations through the shaft shall be sealed in accordance with ARF sealing criteria.

**A. Elevator Operation and Controls:** Special control and emergency service shall be provided in areas serving animal surgery, animal care, and dietary usage. Each elevator bank serving these areas shall be provided with key operated emergency switches for priority service. These switches shall be provided at each landing. This switch will cause the closest available car to bypass other calls in response to an emergency call. An on demand microprocessor system shall be provided for all elevator controls. Controls shall operate properly with a 500 KHZ to 1,300 MHZ radio frequency signal, transmitted at a power level of not less than 100 watts effective radiated power (ERP) at a distance of 1 m (3 ft. 3 in.). The equipment shall be provided with electromagnetic interference (EMI) shielding within FCC guidelines. Noise level rating of the elevator equipment and its operation shall not exceed 80 dBA in the EMRs, measured 1 m (3 ft. 3 in.) above the finished floor and 1 m (3 ft. 3 in.) from the equipment.

**B. Elevator Capacity & Platform Design:** The maximum size of vehicles or other loads and the maximum weight of portable laboratory, biomedical, or X-ray equipment shall be determined before setting the elevator size and capacities. The maximum area allowed by the ASME/ANSI A17.1 Standard shall be used to develop the inside dimensions of car enclosures.

**C. Other Conveying Systems:** Wherever possible, other vertical and horizontal system runs, such as pneumatic tubes, conveyors, and monorails, shall not be located adjacent to, over, or under any acoustically sensitive space. They shall be isolated from the building structure by resilient hangers, isolated support traps, resilient pads, or trapeze hangers and shall have no direct physical connection with the finished ceiling system of the space below. If the horizontal runs are routed over acoustically sensitive spaces such as private offices or examination and treatment rooms, the pneumatic tubes shall be coated with viscoelastic damping compound or other damping material, such as a 25 mm (1 in.) thick glass fiber blanket, with an impervious outer covering such as metal foil. Other pipe sleeving material is available. These materials can be shop applied for the majority of the system run, with field application required only at the joints. If horizontal tube runs are routed over acoustically critical spaces, such as animal breeding or NMR imaging, a suspended ceiling system providing a sound isolation rating in the range of NIC



40 shall be required in addition to the resilient isolation of the service runs. Alternatively, these system runs can be boxed, encased, or wrapped with an impervious barrier material such as dense plaster, gypsum board, or a 51 mm (2 in.) thick glass fiber material with a 96 kg/m<sup>3</sup> (6 lb/ft<sup>3</sup>) density or covered with an impervious outer wrapping such as reinforced leaded vinyl or sheet lead.

In addition to resiliently isolating the service from the building structure, the drive units, transfer or diverter units, and exhauster associated with each type of system runs, motors, pumps, compressors, and gear and drive assemblies shall also be isolated.

### 2.4.5.9 Loading Docks

Loading dock areas shall be designed in accordance with [2.4.3 Materials and Finishes](#). A dedicated route of transport should be identified from the loading dock to the animal facility. Additional information is listed in [Section 4.8 Loading Docks](#). Loading docks must be designed to not negatively impact airflows, or temperature and humidity within the ARF.

### 2.4.5.10 Surgical Suites

Surgical suites require stringent sanitation and decontamination SOPs that are facilitated by high-build finishes and mobile equipment and casework systems. Operating room lighting includes both high-level ambient fixtures and ceiling-mounted articulated-arm surgical lighting that requires above-ceiling structural support.

Large animal operating rooms typically require surgical booms or columns for delivery of medical gases, and other utility services as well as support of specialized equipment that may include monitors and TV equipment. Depending on the manufacturer, this equipment may be either floor or ceiling mounted.

Working clearances around surgical tables must be determined through user discussions. Extensive mobile equipment typically lines the room perimeter. Electrical outlets should be mounted at a minimum of 1.2 m (4 ft.) on center to serve this equipment. Surgical tables may also require power for heating and lifting systems.

Refer to [Section 12.5](#) for requirements for Veterinary Medical Gas Systems requirements for surgery and other parts of the animal research facility.

Small animal surgeries may be performed within procedure rooms; however, dedicated small animal surgical rooms are preferred with downdraft tables to contain aerosols and anesthetic gas. Most surgical procedures require a “clean” environment. An entry anteroom should be considered to allow for positive pressurization of the surgical area without expelling suite air into the corridor.

A lockable drug cabinet shall be provided where narcotics and other controlled drugs are stored.

### 2.4.5.11 Insectaries

For detailed guidance on insect facility design see [Appendix O.1 Insect Facilities](#). Insects are typically housed in environmental chambers that regulate temperature, humidity, and lighting. The lighting control sequence often requires simulated dawn and dusk fade periods to enhance breeding. Chambers vary in size from freestanding units to custom-built walk-in rooms. Special design features are required to facilitate detection and containment of escaped insects. These features vary depending on species housed, but often include:

**A. Insect Trap:** Anteroom with wall-mounted mirror and insect trap to help detect and capture escaped insects. This may be located at the suite entry, environmental chamber entry, or both depending on insect type and level of risk.

**B. Low Ceiling and Lighting:** Low ceilings (2.4 m [8 ft.]) with flush lighting to simplify capture of escaped flying insects

**C. Screening:** Screening at all openings (diffusers, exhaust grills, plumbing drains, etc.)

**D. Finishes:** Light-color finishes, furnishings, and countertops to help locate escaped insects

**E. Inaccessibility:** Mobile casework and equipment that minimize inaccessible areas that could conceal or harbor insects

### 2.4.5.12 Aquatic Holding Rooms

Aquatic holding suites shall be designed to be resistant to water and humidity and to contain water spills. All finishes, fixtures, and furnishings within aquatics rooms shall be moisture and corrosion resistant. Floors shall be slip resistant, sloped towards drains, and sloped

away from doors separating aquatic areas from other areas of the facility. Drains serving aquaria water systems shall be located adjacent to tank systems to prevent aquatic drain piping from causing trip hazards. For larger facilities, equipment rooms housing water purification, filtration, and pumping systems should be separated from aquatic holding rooms. Ceiling heights must account for overhead water distribution piping. Aquatic holding rooms shall meet design criteria previously listed for animal holding rooms in terms of caging layout and clearances, lighting controls, environmental monitoring, etc. Special features may include:

**A. Aquatic Tanks:** Commercially available or custom-fabricated aquatic tanks or aquaria systems, often rack mounted. Space and clearance requirements around aquatic tanks and aquaria racks shall meet criteria previously listed for animal holding rooms.

**B. Aquatic Water Systems:** Commercially available or custom-engineered recirculating or flow-through aquatic water systems with dedicated pumping and filtration capability as well as redundancy to mitigate critical system failures. Aquatic water systems shall be designed to provide the following (each component with  $N + 1$  redundancy):

1. Mechanical filtration that removes 100% of particulates 40 microns or larger, or with greater efficacy if required by facility-specific criteria
2. Biological filtration that removes ammonia and other biological contaminants as required by facility-specific criteria
3. Chemical filtration that maintains aquatic water within chemical-contaminant levels defined by facility-specific criteria
4. “Polishing” filtration just prior to ultraviolet (UV) filtration system if required to maintain water clarity necessary for efficacious UV filtration
5. UV filtration with 100% efficacy for living microbes
6. Temperature control

**C. Dedicated Aquatic Pure-water System:** Dedicated aquatic pure-water system (with  $N + 1$  redundancy), isolated from building laboratory and potable water

systems, sized to provide a minimum of 15% of the total aquatic system volume makeup per twenty-four hours (or larger if required by facility specific criteria)

**D. Finishes:** Water and corrosion-resistant finish systems for partitions, floors, and ceilings

**E. Casework, Equipment and Furnishing:** Water- and corrosion-resistant casework, equipment, and furnishings

**F. Drainage:** Floors sloped to drains to prevent flooding of aquatics rooms and surrounding areas. For larger facilities, trench drains may also be used to capture water from multiple aquaria racks.

**G. Lighting:** Specialized lighting design to provide diurnal, uniform illumination at tiered aquaria and prevent “hot spots” that can cause excessive algae growth. Timer-controlled supplemental lighting is also needed for procedures and caretaking activities requiring higher lighting levels.

#### 2.4.5.13 Animal Imaging

Imaging facilities dedicated for animal use shall comply with requirements listed in [2.4.3 Materials and Finishes](#). Special requirements for vibration limit as well as radiological, electromagnetic, and radiofrequency shielding shall meet equipment manufacturer recommendations. Similarly, layout of imaging and support equipment shall comply with manufacturer’s site planning guides. Special considerations include:

**A. Structural Reinforcement:** Structural reinforcement to accommodate equipment weight

**B. Vibration Isolation:** Vibration isolation as required to meet equipment operating criteria and ensure personnel safety

**C. Shielding:** Shielding (radiological, radiofrequency, electromagnetic) as required to meet equipment operating criteria

**D. Utility Space:** Supplemental utility support to accommodate chillers and other equipment that generate extensive heat output and power consumption. Separate spaces may also be required to house compressors and tanks of compressed and cryogenic gases. These spaces should be accessible from outside the animal facility if possible.



**E. Pathways:** Path of travel for equipment delivery and replacement shall be considered and incorporated into the design.

#### 2.4.5.14 Necropsy

Necropsy or terminal procedure rooms require enhanced sanitation and shall be equipped with stainless steel casework, equipment and countertops. All exposed ductwork and devices shall be stainless steel. Mobile cabinet systems are preferred. Down draft necropsy tables, grossing stations, and other necropsy equipment shall be specified based on user-selected size and optional features. Overhead, articulated-arm treatment lighting is typically required with above-ceiling structural support. Consideration should be given to cold storage to be within close proximity. Additional consideration should be given to specialty gases and monitoring and exhaust.

Depending on the program and the size of the facility, related specialized rooms, including Perfusion and Pathology, may be required. These rooms should be located on the circulation route used for waste to exit the facility.

#### 2.4.5.15 Behavioral Suites

Behavioral suites shall be designed to address the needs of the specific species and programs.

Behavioral enrichment may include play rooms, natural light, views of activities, group housing, animal runs and storage for toys.

Rodent testing rooms may require deep countertops for special equipment, light cycle controls, water tanks (with sink and drain), video cameras. Electrical outlets and other services shall be designed for flexible equipment arrangements without wires on the floor and other hazards.

Non-human primate testing rooms may require group housing, and areas for swinging, climbing, socializing and other activities.

Partitions separating behavioral suites from surrounding areas shall be designed to achieve a minimum sound transmission class (STC) of 58 per ASTM E90. Floor finishes such as industrial-grade seamless vinyl may be considered for noise reduction within the suite. Small animal behavioral rooms may utilize water mazes that require a source of water and drain. Design of behavioral rooms should minimize visual clutter that may be a distraction such as wall-mounted items and directional lighting patterns. Ceiling-mounted curtains may be used to mask extraneous areas. Ceiling-mounted closed-circuit television (CCTV) cameras may be utilized.

#### 2.4.5.16 Administrative Areas

Administrative areas may be designed to office standards provided that they are located outside of the animal facility barrier. Write-up areas and technician workstations located within the barrier shall be designed in accordance with the [2.4.3 Materials and Finishes](#). Space shall be provided in the administrative area for dedicated displays associated with monitoring animal room environmental data, animal drinking water systems, cage wash equipment, telemetry, and other special systems.

---

## 2.4.6 Utility Systems

Utility system components that require adjustment or maintenance shall be configured to allow for service access without entering the animal facility barrier to the greatest extent possible. If access must be located within the barrier, restrict to corridors and other spaces that do not house or service animals. Refer to requirements in engineering sections of the *DRM*.

# Section 2.5

## Biocontainment Facility Predesign

---

### Contents

2.5.0 Introduction

2.5.1 The Master Plan

2.5.2 Project Program

2.5.2.1 Project Parameters

2.5.2.2 Data Collection

2.5.2.3 Documentation

2.5.3 Biocontainment Facility Planning

2.5.3.1 Location Considerations

2.5.3.2 Space Requirements

2.5.3.3 Functional Relationships

2.5.3.4 The Containment Zone

2.5.3.5 Circulation

2.5.3.6 Flexibility

2.5.3.7 Biocontainment Utility Systems

2.5.4 Additional Considerations

2.5.4.1 Select Agent Laboratories

2.5.4.2 Decontamination

2.5.4.3 Security

2.5.4.4 Specialty Areas

2.5.5 Planning and Programming Deliverables

## 2.5.0 Introduction

This section describes predesign requirements for BSL-3 and ABSL-3 research facilities. The BSL-3 and ABSL-3 classifications are categorized by the CDC/NIH Biosafety Microbiological and Biomedical Laboratories (BMBL) as work that involves infectious agents that may cause serious or potentially lethal disease as a result of exposure by inhalation.

“Containment” refers to safe methods for managing infectious materials in the laboratory environment where they are being handled or maintained. The purpose of containment is to reduce or eliminate potential exposure of laboratory workers, other persons, and the outside environment to potentially hazardous agents.

**A. Principles of Biosafety: Barriers:** The principals of biosafety as outlined by the latest edition of BMBL describe two models for laboratory containment: primary and secondary barriers.

1. **Primary Barriers:** Primary barriers are items within the biocontainment laboratory which isolate and contain the infectious agents, and physically separate them from the personnel manipulating them. The use and function of primary barriers are determined by a lab’s standard operating procedures (SOPs), based on a risk assessment, the agents to be used, and the activities to be performed. It is important that the SOPs be established early in the planning process, and that the design professionals have access to them, so that the equipment and procedures associated with primary barriers can be understood and accommodated in the design. Primary barriers include biological safety cabinets (BSCs), lab containers (including centrifuge cups and waste containers) and personal protective equipment (PPE).
2. **Secondary Barriers:** Secondary barriers consist of the physical enclosure of the biocontainment laboratory. The secondary barrier protects people and animals outside of the lab from agents that are inside of the lab, but outside of the primary barriers. Secondary barriers include:
  - a. **Architectural Envelope:** The perimeter walls, floor, ceiling, doors, windows and other elements that surround and contain

the lab must be constructed, finished and sealed sufficiently to prevent leakage and infiltration. Windows must be sealed, and entrances and exits must be minimized. Required entrances and exits must be configured in vestibules with interlocking doors and directional airflow to maintain the integrity of the barrier. Air should enter the room through only two passages: the supply air diffusers and the door opening. Integrity testing of the room envelope should be used periodically to ensure all penetrations are properly sealed.

- b. **Heating, Ventilation and Air Conditioning (HVAC) System:** The HVAC system treats, controls and exhausts the air in the BSL-3 lab, and ultimately releases the filtered air to the atmosphere. The HVAC system must be configured to prevent the release of unfiltered air and maintain directional airflow (generally from the least-hazardous to the most-hazardous areas), during normal operation, emergency and failure scenarios. Refer to [Chapter 6: Mechanical Design](#).
- c. **Waste Treatment:** Waste must be sterilized as it exits the BSL-3 laboratory. Most waste is autoclaved. Liquid sterilized autoclaved waste may discharge through the sanitary or general BSL-2 lab waste. Effluent decontamination systems are only required where approved risk assessment validates the need. PPE, equipment and all other materials leaving the BSL-3 lab must be considered potentially hazardous waste and handled and treated accordingly. Refer to [Chapter 8: Plumbing Design](#).

Requirements listed in [Section 2.1 Research Laboratory Predesign](#) and [Section 2.3 Animal Research Facility Predesign](#) also apply. Where conflicting requirements are provided, this section shall supersede for biocontainment facilities.

BSL-3 enhancements for research involving agricultural agents (BSL-3 Ag) are not included in this section.

**B. Predesign:** The Design Team must have demonstrated prior experience with BSL-3 and ABSL-3 facilities. Stakeholders who must be actively involved in

the planning process include those previously listed in [Section 2.1 Research Laboratory Predesign](#) and [Section 2.3 Animal Research Facility Predesign](#). Early and active participation of the entire group during the planning and programming phase is essential to identify potential design impacts of factors related to occupational health, safety, and security and the inherent risks involved in the study of infectious and sometimes lethal agents.

**C. Risk Assessment:** The design of BSL-3 and ABSL-3 facilities can vary widely depending on agents to be used, types of research and procedures, quantities of agents, animal species caging types, and other risk factors. Their predesign must therefore be guided by a risk assessment that identifies the degree to which risk factors may be mitigated by building design and engineering controls, SOPs, or both. Minimum requirements identified herein are for NIH biocontainment facilities. Additional measures may be required if prescribed by the risk assessment. For additional information about risk assessments, refer to [Section 1.15.6 Risk Assessment, Systems Failure & Disaster Mitigation](#).

---

## 2.5.1 The Master Plan

Master plan issues that may be impacted by construction of a biocontainment facility include minimum setbacks and security requirements that may be required for blast protection, intrusion protection, and protection of exterior elements critical to the operation of the biocontainment facility (e.g., emergency generators, supply air intake, loading docks, etc.). The dispersion of exhaust air shall be considered relative to surrounding facilities and supply air intakes. Planning of these features shall be guided by threat risk and biological risk assessments. Coordinate security requirements with DPSM.

---

## 2.5.2 Project Program

The core of the typical biocontainment facility program consists of infectious disease laboratories and/or animal holding and procedure rooms located within a secure biocontainment zone that is environmentally isolated from other areas using anterooms and engineering

controls to ensure inward directional airflow, facilitate ingress and egress SOPs, and support decontamination procedures. The core biocontainment zone may be supported by transitional areas, decontamination facilities, and an array of support facilities that often eclipses the size of the actual biocontainment area.

Determining the types, sizes, and relationships among these areas requires a full understanding of physical requirements, engineering controls, and the SOPs required to operate, access, and maintain the facility.

### 2.5.2.1 Project Parameters

Special considerations for biocontainment facilities include:

**A. Risk Assessments:** Biological risk assessment and physical threat/risk assessment must be provided to the project team to help guide development of SOPs and the design of the facility.

**B. Special Studies:** It must be determined early in the project planning phase which types of special studies and consultants will be required to establish the criteria related to safety and security of the facility. Typical studies or assessments may include risk assessments, building information modeling, computational fluid-dynamics simulations for laboratory ventilation, chemical use analysis, and environmental assessment. The project team must establish and document the limitations and requirements that each of these criteria will impose on the design.

**C. Community Relations:** Health and safety concerns of neighboring entities outside of the immediate stakeholder group may need to be solicited and addressed to ensure that all perspectives are considered, information is accurately disseminated, and two-way communication is established to facilitate community and regulatory acceptance of the project. A community relations plan including a timeline for communication with elected officials, community leaders, citizen groups, and institutional leadership should be included in the overall schedule.

**D. Infrastructure:** Extensive space may be required to house separate, dedicated, or segregated infrastructure for HVAC systems and other utilities serving biocontainment facilities.

**E. Standard Operating Procedures:** SOPs have an interdependent relationship with facility design and must be

outlined early in the planning process. Detailed SOPs for operation and maintenance of the facility may not be fully developed during early project phases, or may be modified as the project progresses. Ongoing documentation of SOPs that affect design must be included in the project narrative and reconfirmed by the project team in later phases.

**F. Regulatory Requirements:** Local jurisdictional authorities and utility companies must be consulted to determine if special constraints or requirements will affect the location or design of the biocontainment facility. Additional regulations may also affect the design of the facility if select agents and/or agricultural agents are to be used.

**G. Budget:** The cost of a high containment facility design, construction, and operation is significantly higher than conventional BSL-2 laboratories and animal facilities.

Construction estimates developed during the programming phase must identify costs associated with low net-to-gross ratios, infrastructure improvements, enhanced security requirements, special containment and decontamination equipment, high-performance finishes, and regional availability of skilled contractors capable of installing high technology systems. Project budgets must account for lengthy schedules including regulatory approval processes, special studies, and extended commissioning and certification phases. The cost of ownership must also consider operational and maintenance costs, specialized staff recruitment and training requirements, and ongoing obligations for regulatory compliance and recertification. Benchmarking the cost and experience of similar recently constructed facilities is strongly encouraged.

### 2.5.2.2 Data Collection

A supplementary user questionnaire shall be completed for biocontainment projects focusing on SOPs that impact facility design ([Exhibit 2.3 Biocontainment Facilities Program Questionnaire](#)). Specific information required to design the facility will include:

#### A. Containment Zone Entry and Exit Procedures:

1. Procedures for entering and exiting containment
2. Anticipated number of staff working within the containment zone

3. PPE requirements; locations for storing, donning, and doffing PPE; PPE decontamination methodology; location for powered air purifying respirators (PAPR) and recharging (if required)
4. Use and location of hand wash sinks
5. Current or future SOPs for showering if required
6. Separation of men's and women's gowning/shower facilities, if required
7. Communication requirements during the entering/exiting process
8. Transfer of large equipment in and out of containment
9. Use and location of toilets (in or out of containment zone)

**B. Security and Biosecurity Requirements:** Define security requirements including threat protection, access control, CCTV monitoring, and other security features for each zone within the biocontainment facility. Identify where infectious agents will be stored, and what security provisions are required for storage areas and freezers. Identify requirements for secure communication system or data network. Biosecurity control must be approved by the DOHS BioRisk Program. Coordinate security requirements with DPSM.

**C. Waste Management:** Define methods for decontamination, transport and disposal of liquid and solid waste. Establish likely waste volume and minimum sizes for autoclaves and other decontamination equipment.

**D. In Situ Decontamination:** Identify the method(s) for space and equipment decontamination. Identify how and where large equipment will be decontaminated. Identify typical periods and anticipated frequency required for decontamination. Define elements of the HVAC and other utility systems that may require decontamination. Verify corrosive properties and material incompatibilities of decontaminants to be used. If gas or vapor decontamination is required, verify types of equipment and/or systems to be used in this process and HVAC features required to seal areas to be decontaminated.

**E. Facility Shutdown Requirements:** Identify SOPs for facility shutdown and maintenance of the facility during shutdown. Determine if spatial and HVAC zoning is required to enable partial shutdowns.

**F. Maintenance Requirements:** Identify methodology for servicing scientific equipment and utility system components that must be placed or used within the containment zone.

**G. Cage Processing:** Identify animal caging types (isolators, ventilated caging, conventional caging). Identify requirements for in-place and/or centralized decontamination of caging. Identify throughput requirements for caging decontamination as well as minimum chamber sizes if caging is autoclaved. Identify need and methodology for decontamination of waste water if room washdown is required.

**H. Animal Use:** Identify species and numbers of animals to be housed within containment. Identify caging types and cage processing procedures. Identify animal care procedures.

**I. Animal Procedures:** Identify how infected animals will be transported within the containment area. Identify the need for dedicated procedure spaces connected directly to holding rooms versus shared procedure rooms. Identify special procedure requirements (e.g., aerobiology, isolation, etc.).

**J. Carcass Disposal:** Identify volume and methodology of carcass decontamination and disposal.

**K. Agent Transport and Storage Requirements:** Identify how infectious agents will be transported to and from the facility and within the facility between functions areas. Identify how agents will be transported within non-contained and public corridors.

**L. Facility Maintenance:** Identify utility components serving the containment area that will require service access. Identify methodology for servicing components that may become contaminated.

**M. General Operational Issues:** Identify types of procedures and equipment to be used. Identify how house-keeping will be accomplished. Identify how data and communications will be transmitted (fax, Wi-Fi, etc.).

**N. Emergency Procedures:** Identify procedures for emergency egress for both people and animals and shut-down. Coordinate emergency procedures with local fire and rescue, emergency services (EMS), police, and health officials.

**O. Commissioning and Certification Requirements:** Identify schedule and responsibilities for interface with commissioning and certification agents during the entire duration of the project.

### 2.5.2.3 Documentation

Comply with [Section 2.1.2.3 Documentation](#), and submit the following information:

1. Include special studies in the project manual. Exception: Distribution of the threat risk analysis and other information pertaining to security and biological risk shall be limited to personnel designated by the PO.
2. Include a list of SOPs for each type of procedure that may affect design in the project manual. Where possible, include the detailed SOP.
3. Where required, provide enhanced security for documentation and data related to biocontainment facility design.

---

## 2.5.3 Biocontainment Facility Planning

### 2.5.3.1 Location Considerations

Consideration for the location of a biocontainment facility may be affected by several factors:

1. Biocontainment facilities should be located within secure areas isolated from public areas of a building. Adjacency to interstitial floors or other mechanical service zones is highly recommended so that utilities can be safely accessed and maintained without entering into containment areas, and to minimize exhaust duct runs.
2. The ability to buffer the facility from surrounding functions to enhance safety and security as required by security classification
3. Adjacency to facilities that support the project (administrative, laboratory, animal facilities, logistics facilities)
4. Compatibility with neighboring functions



5. Proximity to mechanical areas, utility shafts, and/or interstitial floors available for placement and routing of dedicated utility services

### 2.5.3.2 Space Requirements

Biocontainment facilities typically utilize space less efficiently than their BSL-2 and ABSL-2 facilities because of the space required to house and access redundant, dedicated utility systems.

The amount of space within the containment zone used for working directly with active biological agents is often less than 45% of the overall net program area, and as little as 20% of the total gross area of the facility.

Organizational structure may vary depending on the biocontainment program. Additional factors that should be considered include ABSL-2 and ABSL-3 relationship, because proximity between ABSL-3 areas and the conventional animal research facility greatly facilitates shared use of cage processing and other ARF support facilities.

### 2.5.3.3 Functional Relationships

Functional relationships for buildings containing biocontainment facilities are similar to those of conventional laboratory and animal research facilities except that additional consideration is required for buffering and isolating containment areas. See [Figure 2.5.3.3\(B\)](#). Primary zones include:

1. Personnel zone
2. Laboratory zone
3. Animal zone
4. Containment zone
5. Logistics zone

Functional relationships for cage wash facilities in ABSL-3 are shown in [Figure 2.5.3.3\(A\)](#). Satellite ABSL-3 suites are also feasible provided that proper SOPs are in place for decontaminating cages and waste prior to transport out of the suite.

A connection between ABSL-3 areas and BSL-3 labs may also be desired to facilitate movement of active agents and infected materials between the lab and

holding areas. This is particularly important with highly pathogenic agents that may present additional risk or operational complexity to package and transport out of the biocontainment barrier.

### 2.5.3.4 The Containment Zone

The containment zone may include BSL-3 facilities, ABSL-3 facilities, or both. The containment zone shall be enclosed by a clearly defined physical barrier including partitions, floor, and ceiling that separate it from non-containment areas of the facility. Work with infectious agents within the containment zone is generally performed in BSCs that provide the primary containment for pathogens; however, the physical barrier provides secondary containment and must be constructed to achieve inward directional airflow. Construction of the barrier and all partitions, floors, and ceilings within the barrier require special detailing and finishes that enhance sanitation, withstand chemical decontamination, and resist uncontrolled air migration.

Anterooms must be designed according to the same standards as other spaces within the containment zone.

### 2.5.3.5 Circulation

Movement of staff, materials, equipment, and waste in and out of the containment zone requires the use of a directionally pressurized anteroom to provide separation from areas with unrestricted traffic flow. Anterooms shall be designed to accommodate the storage and donning of required PPE. This passage shall be arranged with two sets of self-closing doors. The anteroom doors shall be interlocked to prevent simultaneous opening of doors between the outside corridor and containment areas. Entrance interlocks, when present, shall be provided with a manual override for use in case of emergency. A visual indicating device is required to verify directional airflow and confirm the proper operation of the engineering controls providing directional airflow into the containment zone. Directional airflow is required from the outside corridor into the anterooms and from the anteroom into the containment area.

There are many design variations that address this requirement. Factors that must be considered include:

Figure 2.5.3.3(A) Typical relationships between cage processing functions and ABSL-3 zone

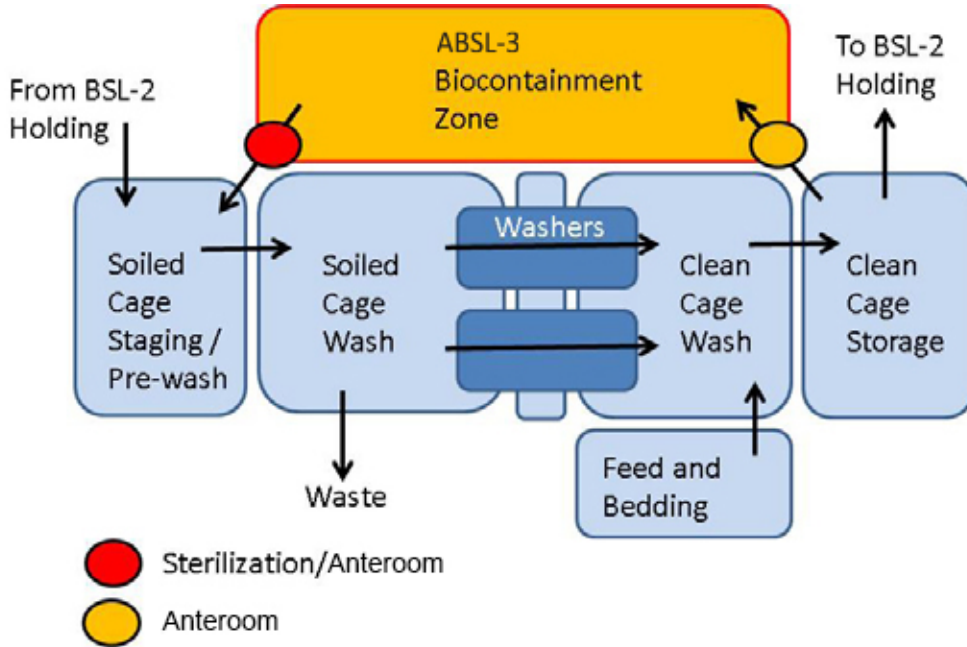
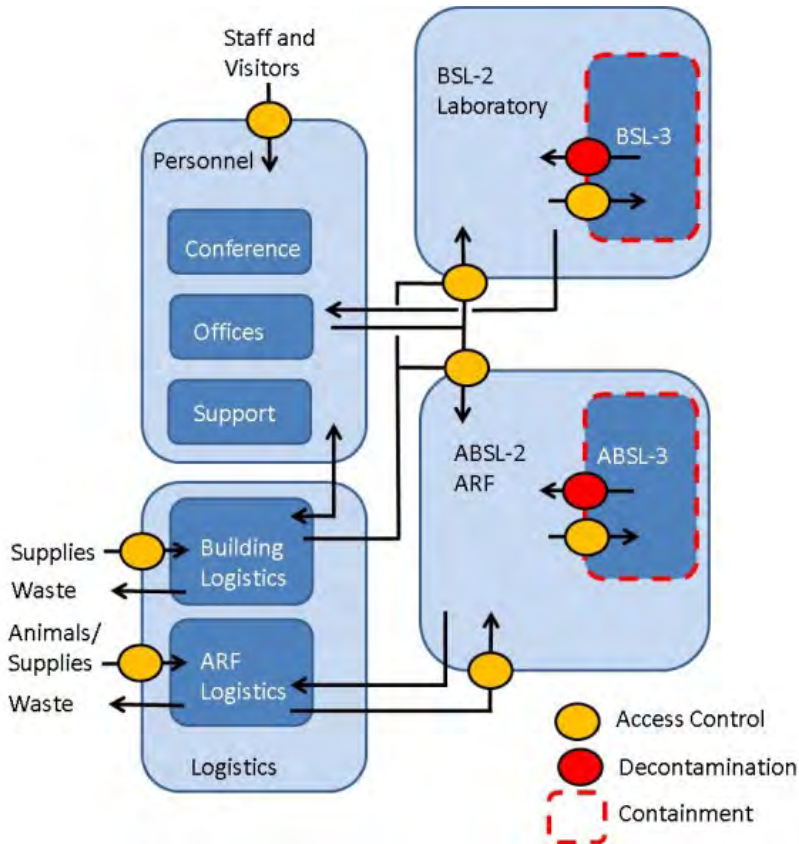

Figure 2.5.3.3(B) Example of relationships between primary building zones, including containment zones



**A. Throughput:** Anterooms must be designed to accommodate the number of staff using the facility. This includes both normal transit as well as emergency egress. Factors affecting throughput include time required to don and doff PPE, and time and facilities required for decontamination prior to exiting (PPE spray down, shower-out, privacy issues).

**B. PPE:** Requirements for PPE including disposable as well as laundered materials, PAPR recharging stations, lockers, waste bins, etc.

**C. Showers:** Risk assessment may require the use of pass through showers in the exiting sequence. When not required, consideration should be given to the addition of showers for future flexibility.

**D. Decontamination:** Anterooms may house autoclaves and fumigation chambers used to decontaminate materials and equipment removed from the containment zone. If this is the case, space required to house and service equipment and store load carts must also be considered. Hand wash sinks may also be required, depending on SOPs for glove removal.

**E. Equipment Transport:** A pathway for transit of large equipment used within the containment zone such as freezers, biological safety cabinets, etc., must be defined. Anterooms used for this purpose should be sized to accommodate the largest equipment item. A room or chamber for the decontamination of large equipment shall be evaluated during predesign.

**F. Security:** Biometric access control may be required for entry into the containment area based on program or threat risk assessment. Coordinate security requirements with DPSM.

Examples of two containment-area-anteroom alternatives are illustrated in Figure 2.5.3.5. Because anteroom designs are closely related to SOPs, programs must develop optimal arrangements based on their specific needs.

### 2.5.3.6 Flexibility

The type of construction and intensity of infrastructure required in biocontainment facilities is inherently inflexible from the standpoint of partition changes and

Figure 2.5.3.5 Examples of two containment-area-anteroom alternatives

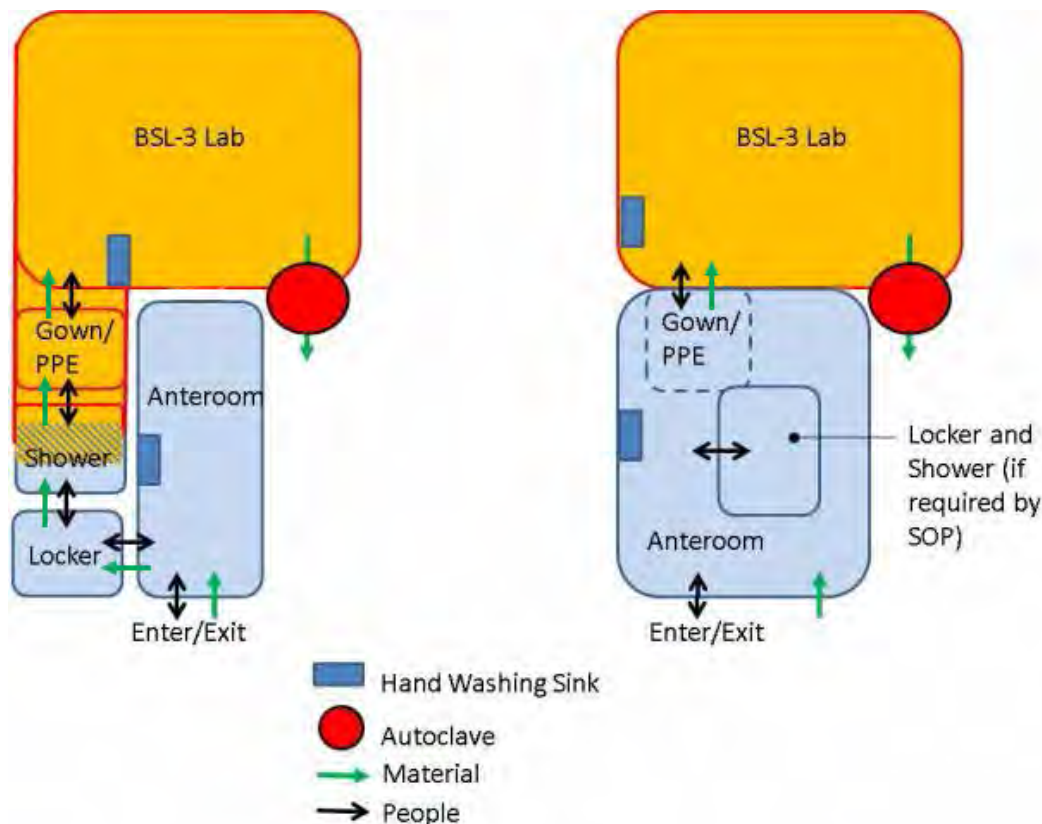

repurposing. However, there are still opportunities to plan for flexibility.

**A. Compartmentalized Design:** The hazardous nature of work performed in containment labs is not usually suited to large, open-bay configurations. Compartmentalization into multiple self-contained one- or two-module suites that minimize the possibility of cross-contamination has several advantages:

1. Work with different infectious agents may be incompatible due to the need for different SOPs for use, storage, personal protection, decontamination, vaccines, and training. If a single suite is used, the most restrictive SOPs may apply regardless of the agent in use.
2. Partial shutdown of a single compartmentalized suite for repairs or decontamination does not necessarily require shutdown of the entire containment zone, provided that utility systems are similarly compartmentalized to allow for isolation of each suite.
3. Security protocols may differ among agents, requiring selective use of staff, forced entry protection, and enhanced surveillance or biosecurity measures. This is more easily addressed in compartmentalized suites.
4. Use of multiple suites with dedicated holding and procedure rooms within the ABSL-3 containment zone can enhance flexibility by minimizing the need for transporting infectious animals and materials.

**B. Flexible Casework Systems:** Mobile casework systems are particularly useful in containment applications because they are generally more easily decontaminated and can be rearranged without utilizing outside contractors. This is applicable to other fixed elements that can be “plugged in” versus “hard wired,” including equipment, task lighting, etc.

**C. Decontamination:** Use of large, centralized decontamination equipment versus smaller equipment localized within each suite should be evaluated. The ability to decontaminate material before it leaves the suite may simplify SOPs and enhance safety. This is typically impractical in ABSL-3 facilities where large volumes of contaminated caging and cage racks require bulk

autoclave and/or fumigation chambers. When this is the case, SOPs for moving contaminated or partially decontaminated materials must be fully understood to ensure that the physical layout supports the proposed SOPs.

### 2.5.3.7 Biocontainment Utility Systems

**A. Dedicated Systems:** HVAC, plumbing, and other utility systems serving containment zones shall be segregated from systems serving other areas of the building to minimize the risk of cross-contamination.

**B. Maintenance Access:** Utility system components that require maintenance access, adjustment, or calibration shall be located outside of the containment zone. Where possible, an interstitial mezzanine should be considered. Adequate clearance and working space, including ceiling height, must be provided for the performance of all maintenance activities.

**C. Compartmentalization:** If partial shutdown of the containment zone is a design criterion, utility systems must be configured to align with the space compartmentalization strategy. This is particularly important for high-efficiency particulate air (HEPA) filtration zones and exhaust ductwork that must be configured to allow individual suites to be decontaminated without total facility shutdown. Consideration should also be given to the use of redundant or dual HEPA-filter caissons to facilitate filter testing and replacement without suspension of containment-zone operations in areas that must remain operational during partial suite shutdowns, such as shared corridors.

**D. Decontamination:** Methodologies for decontaminating utility system components exposed to the containment environment must be determined, and appropriate elements provided.

**E. Directional Airflow:** The BMBL requires directional airflow into the containment zone through two self-closing doors. Within the containment zone, there are further requirements for directional airflow among rooms and suites to ensure that air moves towards the most contaminated areas, and to protect research from potential cross-contamination. Early interaction among the architect, engineers, DOHS and commissioning agent is essential to ensure that engineering systems and controls can deliver the directional airflow required to support the proposed spatial arrangement and SOPs.

An airflow diagram illustrating directional airflow at each doorway is required to communicate intent among architects, engineers, and users during design.

**F. Leak and Flood Prevention:** Floors of mechanical rooms and interstitial levels shall be designed to prevent leaks. Concrete floors shall have a waterproof finish or sealer, and penetrations through the floor shall be protected by raised curbs or sleeves or otherwise configured to contain water and prevent leaks.

## 2.5.4 Additional Considerations

### 2.5.4.1 Select Agent Laboratories

The A/E shall contact the Select Agent Program (SAP) Responsible Official (RO), as identified by DOHS, if a select agent is to be used in the laboratory. The A/E shall also contact the DPSM if the biosafety level is greater than BSL-2 or ABSL-2. General principles of the SAP laboratory design in the planning stage shall include:

1. Input of the user and NIH SAP, responsible official/alternate responsible official in tandem
2. Determination of the select agent needs for the principal investigator (PI), i.e., long term storage, growing of materials, animal usage, etc.
3. Review by DOHS

General principles of SAP laboratory design in the design stage shall include:

1. The ability to physically segregate personnel and equipment into separate workstations dependent upon the different organisms to be handled by the principal investigators (PIs)
2. Participation of the Security and Emergency Response (SER), the DPSM, and ORS in the discussions as early in the design process as possible with full knowledge of the intent to use select agents.
  - a. Category A agents require cameras for long term storage and a dual method of security access control.

Additionally, all select agent laboratories' designs shall include:

1. Compliance with the BMBL – Any “recommendation” for facility design made in the CDC/NIH BMBL is a regulation for each select agent laboratory (42 CFR 73).
2. Compliance with the DHHS/SAP 12-point plan
3. Specification requirements for documentation (mechanical and plumbing reports) needed to register a laboratory with the CDC
4. Controlled access
5. Use of tamper-resistant high-security cylinders for keyed doors on the facility master lock only

Any value engineering discussions, design modifications, renovations, or questionable items shall be reviewed by both the DOHS and the PI prior to final approval.

### 2.5.4.2 Decontamination

Planning must identify proposed methodologies for decontamination for waste, material, carcasses, equipment, and room surfaces.

Decontamination of waste and materials exiting the containment zone is best accomplished at the containment barrier to minimize risk associated with transporting potentially contaminated materials out of the containment zone; however, materials that are bagged and surface decontaminated may be fully sterilized outside of containment if allowed by the risk assessment.

Autoclaves are most commonly used for decontaminating waste and material. Tissue digesters may be used for decontamination and disposal of animal carcasses if allowed by the local sewer authority. The location of both autoclaves and tissue digesters must be coordinated with SOPs for waste decontamination and disposal. A pass through autoclave from containment to an anteroom outside of the containment barrier eliminates the need for transport of contaminated material outside of containment; however, it may require the use of multiple units for compartmentalized suites. If shared equipment is used, a location within the security perimeter must be provided and procedures for surface decontamination and transport of contaminated material to the autoclave or digester must be identified.



Surface decontamination with chemical disinfectants or fumigation with gas or vapor is most commonly used for decontaminating large equipment and room surfaces. Each decontamination methodology has design implications and limitations regarding the chemical resistance of finishes, the location of decontamination equipment, the distribution of the disinfecting agent, cycle time, and efficacy that must be considered so that physical features and finishes can be designed to support the proposed procedures.

Special detailing is required to seal penetrations through walls, floors, and ceilings to resist uncontrolled air migration and facilitate the use of gas and vapor decontamination.

#### 2.5.4.3 Security

Security features shall be planned to respond to the threat risk assessment as determined by DPSM or the AHJ in locations outside of the NIH campus. Security considerations for the containment zone and the building housing the biocontainment facility shall include:

1. Vehicular and/or personnel exclusion zones for the building site
2. Blast protection
3. Access control, security guard station, forced entry protection, and CCTV surveillance for the building
4. Forced entry protection and CCTV surveillance for the containment zone
5. Special requirements for select agent storage
6. Security for communications and data associated with the biocontainment facility and research
7. Utility rooms and interstitial areas serving containment areas shall be provided with access control.
8. Limited distribution of plan and design documentation associated with the facility should be considered. Details regarding security features, storage of biological agents, and other sensitive data shall be annotated in a manner that allows

documents to enter the public realm when necessary for permitting community relations and other purposes.

#### 2.5.4.4 Specialty Areas

**A. Aerobiology:** ABSL-3 facilities may require a specially equipped procedure room used for infecting animals via inhalation of aerosolized agents. This equipment is typically housed in a dedicated room and shared by all suites within the containment zone. Depending on the animal species and type of inhalation (nose only, whole body, etc.) equipment required to support this procedure may range from a class II BSC to an exhausting class III BSC. Procedure rooms housing this high-risk operation should not be provided with floor drains, and may require anterooms with pass through showers. Planning considerations must account for the space required for specialized equipment, decontamination procedures and personnel involved in the procedure, as well as the methodology of transporting infected animals to and from the aerobiology suite.

**B. Imaging:** Imaging equipment used in biocontainment facilities is typically housed in a dedicated suite with an anteroom, and shared by all suites within the containment zone. Imaging suites may require unique design solutions to accommodate the program requirements and the movement of animals. Imaging equipment located within containment must be certified to be capable of withstanding decontamination without voiding manufacturer warranties or isolated from exposure to the contaminated side of the biocontainment barrier.

**C. Large Animal Facilities:** Large animal research may utilize caging that must be cleaned in place or fumigated prior to transport to cage wash areas. If open caging is used, the holding room will become the primary containment barrier and additional enhancements may be required. The holding rooms may also require cleaning with hoses between studies, after decontamination. Planning must include methodology for capturing and decontaminating effluent generated by this process, as well as SOPs for transport of both infected and uninfected large animals. Transportation may include track lifts and hoists. If an infected animal is transported to the laboratory provisions for wash down of the vehicle cargo area and wheels must be provided.



**D. Insectaries:** Insects are a common vector for transport of infectious diseases. ABSL-3 insectaries require special design considerations compliant with [Appendix O.1 Insect Facilities](#) as well as the most recent version of the Arthropod Containment Guidelines published by the American Society of Tropical Medicine and Hygiene to ensure that infected insects are contained within the suite. Risks associated with conducting research involving insects within a containment facility housing potential host animals must be addressed by the risk assessment.

**E. Other Requirements:** Equipment control rooms and serviceable components should be located outside of containment to the greatest extent possible.

## 2.5.5 Planning and Programming Deliverables

Refer to [Section 2.1.4 Predesign Deliverables](#), [Section 2.4.4 ARF Security](#), and [Appendix E: A/E Submission Requirements](#) for Predesign Deliverable Requirements. Additional requirements are as follows:

1. Biocontainment Facilities Program Questionnaire ([Exhibit 2.3](#))
2. SOP descriptions for items listed in [Section 2.5.2.2 Data Collection](#)
3. Airflow diagram for the containment zone
4. Throughput assumptions and calculations validating that decontamination equipment is properly sized
5. Special studies listed in [Section 2.5.2.1 Project Parameters](#)
6. Throughput assumptions and calculations for personnel entry and exiting, including use of pass through showers where applicable.

# Section 2.6

## Biocontainment Facility Design

---

### Contents

2.6.0 Introduction

2.6.1 Conceptual Design Considerations

2.6.1.1 Modular Design

2.6.2 Facility Design Requirements

2.6.2.1 Exterior Envelope

2.6.2.2 Partitions

2.6.2.3 Floors

2.6.2.4 Ceilings

2.6.2.5 Penetrations and Sealants

2.6.2.6 Doors, Frames, and Hardware

2.6.2.7 Windows

2.6.2.8 Access Panels

2.6.2.9 Casework

2.6.2.10 Equipment

2.6.2.11 Signage

2.6.3 Security

2.6.4 Additional Considerations

2.6.4.1 Design Documentation

## 2.6.0 Introduction

In this section, requirements for the design phase of BSL-3 and ABSL-3 projects, collectively referred to as biocontainment projects, are outlined. Refer to [Section 2.5 Biocontainment Facility Pre-design](#) for pre-design requirements, [Section 2.2 Research Laboratory Design](#), [Section 2.3 Animal Research Facility Pre-design](#) for general design requirements and [Chapter 4: Architectural Design](#) for specific design requirements. For biocontainment-specific requirements, adhere to the directions given in this section.

## 2.6.1 Conceptual Design Considerations

The conceptual design of high containment facilities shall be developed to demonstrate responsiveness to organizational, operational, and infrastructure requirements identified in the plan and program development phase. Enhanced environmental and personal protection shall be provided, as identified by the program, DOHS, DPSM, threat risk assessment and other authorities. Enhancements may include showers and dressing rooms, security and biosecurity measures, effluent decontamination, enhanced systems filtration and isolation.

### Organizational issues include:

1. Clear identification of the containment zone boundaries and barrier partitions
2. The relationship between BSL-3 containment areas and related laboratory and logistical functions both inside and outside the containment barrier
3. The relationship between the ABSL-3 containment area and other components of the ARF
4. The relationship between BSL-3 and ABSL-3 containment areas (if applicable)

### Operational issues include:

1. Circulation of visitors, staff, materials, animals and waste among different functional zones
2. Workflow within containment areas

3. SOPs outlined in [Section 2.5 Biocontainment Facility Pre-design](#), including:
  - a. Containment zone entry and exit procedures
  - b. Waste and general decontamination procedures and methodologies
  - c. Security and biosecurity requirements
  - d. Facility shutdown and maintenance procedures
  - e. Cage decontamination and processing procedures
  - f. Agent transport and storage
  - g. Emergency procedures
  - h. Equipment throughput
4. Staff throughput
5. Logistical support
6. Security strategy
7. Storage

### Infrastructure issues that affect the design include:

1. Capacities, location, and size of utility systems dedicated to containment zones
2. Utility distribution methodology
3. Maintenance access methodology
4. Redundancy strategy

Conceptual design must respond to each of these issues to confirm validity and allow for comparative analysis.

### 2.6.1.1 Modular Design

Modular design shall generally comply with the modular design approach for laboratory and animal research areas described in [Section 2.2.2 Modular Design](#) and [Section 2.4.2 Modular Design](#); however, wider modules may offer more flexibility for accommodating the multiple BSCs providing primary containment in BSL-3 laboratories.

## 2.6.2 Facility Design Requirements

### 2.6.2.1 Exterior Envelope

Containment areas located along the exterior wall shall comply with requirements identified by the threat risk assessment for visual privacy, blast protection, and forced entry protection. Use of a buffer corridor or secondary partition should be considered to prevent thermal movement and infiltration of outside air and vapor due to a strongly negative pressure differential within the containment suite.

### 2.6.2.2 Partitions

Partitions within the containment barrier shall be designed to resist damage from lateral deflection caused by differential air pressure surges that may occur during HVAC fan failure testing. Partition construction shall be appropriately moisture and impact resistant, and be designed for equipment, shelving and other lateral loading.

### 2.6.2.3 Floors

Floors shall have a seamless, slip-resistant finish with integral coved base. Flooring shall be non-absorbent, smooth, pinhole free, easily sanitized, and resistant to degradation from chemicals, disinfectants, and decontaminants.

### 2.6.2.4 Ceilings

Ceilings shall be monolithic, seamless construction. Ceilings systems shall be designed to resist damage from deflection (uplift and downward pressures) caused by differential air-pressure surges that may occur during HVAC fan-failure testing. Ceiling material and support systems shall be designed to be moisture and sag resistant.

### 2.6.2.5 Penetrations and Sealants

All penetrations into and through partitions, floors, and ceilings shall be sealed to enhance sanitation, facilitate gas and vapor decontamination, and resist air infiltration. All equipment integral to the containment barrier requires a manufacturer supplied biological seal

in the containment wall. The biological seal shall be a structurally stable, mechanically fastened gasketed seal capable of containing decontaminating gas and allowing for differential movement and remaining intact for gaseous decontamination protocols.

### 2.6.2.6 Doors, Frames, and Hardware

Doors shall be seamless with no top or bottom recesses. Cutouts in doors and frames shall be sealed to enhance sanitation and resist air infiltration. Doors and door hardware shall be free of sharp edges. Door hardware shall be easily operated with PPE.

### 2.6.2.7 Windows

Window frames shall be fully welded and sealed. Frames shall be foam filled or otherwise sealed to prevent infiltration. When windows are located in the barrier wall, removable glazing stops shall be located on the non-containment side of the barrier. Glazing shall be tempered safety or laminated glass.

### 2.6.2.8 Access Panels

Access panels within biocontainment laboratories shall be minimized. Access panels in ceilings and walls shall be gasketed and secured by latches that ensure a gas-tight seal.

### 2.6.2.9 Casework

Provide wall-mounted or frame-mounted countertops or movable tables and mobile or suspended base cabinets to enhance flexibility, sanitation, and decontamination.

### 2.6.2.10 Equipment

Equipment dimensions and weight shall be coordinated to ensure that large items can be transported through the path of travel into the containment zone including entry anterooms. Recessed wall-mounted equipment shall be specified with fully sealed cabinets or back boxes to facilitate sanitation and decontamination, and eliminate unforeseen pathways for air infiltration.

Required equipment may include autoclaves, biological safety cabinets, tissue digesters, pass through cabinets, dunk tanks, and equipment for decontamination.

### 2.6.2.11 Signage

A hazard sign incorporating the universal symbol for biohazard and designating BSL-3 or ABSL-3 occupancies shall be posted on all entry doors, and in any areas where infectious materials are used or stored. Additional signage may be required to be posted. Confirm requirements with the program and with DOHS.

---

## 2.6.3 Security

Physical security requirements shall conform to criteria established by the threat risk assessment and as designated by the DPSM and DOHS.

The containment zone shall be physically separated from other areas of the building. The containment zone perimeter shall conform to criteria established for forced entry. Consideration should also be given to controlling access to corridors serving the biocontainment zone.

Doors accessing the containment zone shall be self-closing and lockable from the side opposite egress travel. Card access is required. Additional security requirements, including biometric access, shall be provided as determined by program and risk assessment. Coordinate security requirements with DPSM.

## 2.6.4 Additional Considerations

Where allowed by the program, antifatigue floor mats shall be provided in areas where prolonged standing is expected; mats must be appropriately edged to permit smooth passage of wheeled equipment when necessary.

### 2.6.4.1 Design Documentation

Design documents shall include large scale penetration details for each type of barrier wall, floor and ceiling penetration including bioseals. Details shall be collocated in the drawing set and referenced by each discipline within their respective drawings. Details shall indicate anchorage for penetrating item, types of materials used, location and types of sealants (coordinated with the NIH Sealant Schedule), and trade responsible for installation of various components.

# Exhibit 2.1

## Research Facilities Program Questionnaire

The purpose of this questionnaire is to obtain information necessary to produce the Program of Requirements (POR) for BSL-2 laboratories.



## 1.0 Program Requirements

- 1.1 List all of the institutes/centers to be accommodated in this space.
- 1.2 Provide a general description of the research/work/studies to be performed in the facility.
- 1.3 Identify project stakeholders and responsibilities.
  - 1.3.1 Identify the contacts and their roles.
- 1.4 Identify all staff and occupants anticipated to be located within this space.
  - 1.4.1 Identify roles of all staff.
- 1.5 Identify the safety officer.
- 1.6 Identify the authority responsible for hazardous material inventory.
- 1.7 Identify primary project objectives, goals, and the vision for the new facility.
- 1.8 Identify the assigned square feet (square meters) for the project.
- 1.9 Identify primary, support, and core laboratory functions to be provided
- 1.10 Identify office, administrative, and personnel functions to be provided.
- 1.11 Identify proposed animal research use and access requirements. If on-site, complete the Animal Research Facility Program Questionnaire.
- 1.12 List attributes and deficiencies of your current laboratory workspace.
- 1.13 Identify material storage requirements.
- 1.14 Identify need for personnel lockers.
- 1.15 Identify any peer-comparable institutions/facilities for use in benchmarking.
- 1.16 Equipment Schedule
- 1.17 Room Data Sheets

## 2.0 Functional Relationships

- 2.1 Describe functional relationships among program components.
  - 2.2 Identify functions that can share space and functions that require separation.
  - 2.3 Identify opportunities for sharing equipment and core functions.
  - 2.4 Identify preferred location of offices and write-up areas relative to labs.
- 

## 3.0 Standard Operating Procedures

- 3.1 Describe the anticipated workflow for each type of activity and research initiative.
  - 3.2 Provide applicable SOPs.
  - 3.3 Describe desired personnel, material, and waste flow through the program area.
  - 3.4 Identify desired security hierarchy and special security requirements.
  - 3.5 Identify personal protection equipment and gowning requirements.
  - 3.6 Identify requirements for regular delivery acceptance/access.
  - 3.7 Describe decontamination procedures and sterilization requirements.
- 

## 4.0 Design Parameters

- 4.1 Identify proposed biosafety level(s).
- 4.2 Identify existing conditions that may limit the use of the facility or negatively affect the project.
- 4.3 List sustainability objectives and features desired for this project.

- 4.4 List hazardous materials (chemical and radiological) to be used and stored within the project area (use Chemical Inventory template for collecting this information).
  - 4.5 Will any spaces require special clear-height considerations for equipment or apparatus?
  - 4.6 Will any spaces include equipment or other items that may require special structural considerations due to weight?
  - 4.7 Will any spaces require special vibration-isolation requirements or contain vibration-sensitive research/equipment?
  - 4.8 Will any spaces require special acoustical considerations?
  - 4.9 Will any spaces require special conveying requirements (i.e., pneumatic tube distribution or other)?
  - 4.10 Will any spaces require special hoisting requirements (i.e., crane, monorail, or other)?
  - 4.11 Will any spaces require special finishes for high moisture or corrosion resistance?
- 
- 5.4 Identify any special lighting controls requirements.
  - 5.5 Identify any higher densities of standard 120V receptacles required other than normally provided.
  - 5.6 Other than standard 120V receptacles, what other specialty electrical wiring devices or other utilization voltages are required?
  - 5.7 Identify any laboratory equipment requiring emergency power (if available) (noting that emergency power will be affected by more outages due to routine emergency distribution system testing).
  - 5.8 Identify any special grounding requirements.
  - 5.9 Identify any conditioned power requirements.
  - 5.10 Identify any special magnetic area concerns.
  - 5.11 Identify any special RF/EMI shielding requirements.
  - 5.12 Identify any scientific equipment monitoring requirements.
  - 5.13 Identify any specialty systems or alarms required specific to laboratory areas.
  - 5.14 Identify any special telecommunications requirements.
  - 5.15 Identify any security card access control requirements.
  - 5.16 Identify any CCTV surveillance requirements.

## 5.0 Electrical Parameters

- 5.1 Are any laboratory areas considered as wet or damp locations?
- 5.2 Identify any special or unusual lighting requirements.
- 5.3 Is task lighting required (noting that this will reduce overhead ambient lighting due to lighting energy density concerns)?

# Exhibit 2.2

## Animal Research Facility Program Questionnaire

The purpose of this questionnaire is to obtain information from the customer that is necessary to produce the Program of Requirements (POR) for BSL-2 research animal facilities.

## 1.0 General Requirements

- 1.1 List all of the institutes/centers to be accommodated in this space.
  - 1.2 List project stakeholders and responsibilities.
  - 1.3 List the point of contacts and their roles.
  - 1.4 Provide all staffing and occupancy requirements and anticipated roles within this space.
- 

## 2.0 Program Requirements

- 2.1 Describe project objectives including schedule and budget.
  - 2.2 Provide the assigned square feet (square meters) for the project.
  - 2.3 Identify office, administrative, conference/training, and personnel functions to be provided.
  - 2.4 Are lockers, showers, toilet facilities required? Separate men's and women's facilities? Pass through design?
  - 2.5 List attributes and deficiencies of your current facility.
  - 2.6 Define material storage requirements.
  - 2.7 Specify quantity for personnel lockers.
  - 2.8 Specify number and size of janitor closets and describe their contents and function.
- 

## 3.0 Functional Relationships

- 3.1 Describe functional relationships among program components.
- 3.2 Specify preferred location of offices and tech areas.

## 4.0 Animal Holding and Caging

- 4.1 Identify each population of animals to be housed (species, number, health status) and potential for additional or different animal models in the future.
  - 4.2 List types of caging to be used for each group (existing and new), and whether power or ventilation is required.
  - 4.3 Identify required separation among groups and need for barrier suites.
  - 4.4 Identify animal holding room requirements for each group (features, drains, sinks, cages/room, equipment, environmental requirements, etc.) and determine quality of holding/procedure convertible rooms.
  - 4.5 Identify sanitation procedure and schedule for each animal group.
  - 4.6 Define animal intake and quarantine holding requirements.
  - 4.7 Identify noise, vibration or other special requirement for each animal group.
- 

## 5.0 Procedure Space

- 5.1 Provide types and sizes of desired procedure rooms and required proximity to animal holding areas and determine quality of holding/procedure convertible rooms.
- 5.2 Specify whether a necropsy room is needed.
- 5.3 Specify if any and what types of advanced imaging areas are required.
- 5.4 Indicate whether/what type of specialized areas (gamma cell, aquatics, surgical facilities, isolation rooms, rederivation, etc.) are required.
- 5.5 Is any survival surgery performed within animal facility?

## 6.0 Standard Operating Procedures

- 6.1 Describe desired personnel, material, and waste flow through the facility.
  - 6.2 Provide all applicable SOPs.
  - 6.3 Identify desired security hierarchy and special security requirements.
  - 6.4 Identify security protocols.
  - 6.5 Identify emergency management procedures.
  - 6.6 Identify personal protection equipment and gowning requirements and entry/exiting procedures for different areas of the facility.
  - 6.7 Identify delivery schedule, storage and sterilization requirements for feed, bedding, and other materials.
  - 6.8 Specify whether laundry will be used and/or cleaned on-site.
  - 6.9 Describe decontamination procedures and sterilization requirements (waste, space, caging, animal carcasses, and material).
- 

## 7.0 Cage Processing Standard Operating Procedures

- 7.1 Provide cage change schedule and preferred change method (stationary or rolling change station, BSC, etc.) for each caging type.
- 7.2 Detail decontamination and sanitation procedure for each caging type.
- 7.3 Provide bedding waste-disposal standard operating procedure.
- 7.4 Identify desired permanently installed sanitation and sterilization equipment, including minimum chamber or belt sizes, if known.

## 8.0 Design Parameters

- 8.1 Identify proposed biosafety level(s).
  - 8.2 Detail environmental parameters for each animal housing group (temperature, humidity, air change rate, lighting).
  - 8.3 List sustainability objectives and features desired for this project.
  - 8.4 List hazardous materials (chemical and radiological) to be used and stored within the project area (use Chemical Inventory template for collecting this information).
  - 8.5 Identify any special noise or vibration restrictions.
- 

## 9.0 Technical Requirements

- 9.1 Complete Room Data Sheet for each type of desired space (use Room Data Sheet template).
- 9.2 List required services (i.e., CO<sub>2</sub>, O<sub>2</sub>, vacuum, compressed air, anesthesia gas, etc.) and location required (use Room Data Sheets).
- 9.3 Define animal drinking water requirements and distribution approach.
- 9.4 Define sink, eyewash fountain, and deluge shower requirements (use Room Data Sheets).
- 9.5 Identify type and location of casework (use Room Data Sheets).
- 9.6 Define any special signage or program identification requirements.
- 9.7 Define drain and floor sloping requirements (use Room Data Sheets).
- 9.8 Identify desired noise limitations for alarm systems.
- 9.9 Specify minimum door sizes.
- 9.10 Specify minimum ceiling heights.
- 9.11 Define requirements for environmental monitoring.
- 9.12 Define special communication requirements (intercom, Wi-Fi, etc.).

## 10.0 Equipment Requirements

- 10.1 Identify all existing and new ARF equipment to be housed within this space (use Equipment Schedule template for collecting this info).
- 10.2 Provide equipment data sheets for existing and proposed equipment.
- 10.3 Identify equipment items that require unusual or excessive clearances, structural support, headroom, vibration control, sound isolation, or other physical features.

---

## 11.0 Proposed Project Site

- 11.1 Specify the proposed project location.
- 11.2 For renovations, identify physical condition and known spatial and infrastructure deficiencies.
- 11.3 Identify and/or provide any available documentation for current and proposed space.

---

## 12.0 Electrical Requirements

- 12.1 Identify cord and plug connected equipment to be provided in cage wash areas.
- 12.2 Identify special lighting requirements other than standard fluorescent lamp sources required.

- 12.3 Is any permanently installed exam lighting required, and in which locations?
- 12.4 Identify any special lighting controls required other than user adjustable standard animal holding diurnal cycle with caretaker overrides.
- 12.5 Identify any higher than normal densities of standard 120V receptacles.
- 12.6 Identify other required specialty electrical wiring devices or other utilization voltages.
- 12.7 Identify any laboratory equipment truly requiring emergency power (if available) (noting that emergency power will be affected by more outages due to routine emergency distribution system testing).
- 12.8 Identify any special grounding requirements.
- 12.9 Identify any conditioned power requirements.
- 12.10 Identify any special magnetic area concerns.
- 12.11 Identify any special RF/EMI shielding requirements.
- 12.12 Identify any scientific equipment monitoring requirements.
- 12.13 Identify any specialty systems or alarms required specific to vivarium area.
- 12.14 Identify any special telecommunications requirements.
- 12.15 Identify any CCTV surveillance requirements.
- 12.16 Identify any electronic door interlocking schemes requirements.



# Exhibit 2.3

## Biocontainment Facilities Program Questionnaire

The purpose of this questionnaire is to obtain information necessary to produce the Program of Requirements (POR) for BSL-3 laboratories and ABSL-3 animal facilities. It is intended to be used in conjunction with Exhibit 2.1 Research Facilities Program Questionnaire provided for BSL-2 laboratory facilities and Exhibit 2.2, Animal Research Facility Program Questionnaire for ABSL-2 research animal facilities.

# BSL-3 Laboratories

## 1.0 Program Requirements

- 1.1 Define the mission and design intent of the project, agents to be studied, types of procedures, and equipment to be used.
- 1.2 Define requirements for compartmentalization of different areas within the containment zone.
- 1.3 Define requirements for proximity to ABSL-3 research animal holding and procedure rooms.
- 1.4 Identify critical adjacencies.

## 2.0 Regulatory Requirements

- 2.1 Specify if any select or agricultural agents are to be used.
- 2.2 Identify regulatory requirements related to the agents to be utilized.
- 2.3 Verify that a risk assessment has been completed, and identify provisions of the assessment that may affect facilities, standard operating procedures, and engineering controls.
- 2.4 Identify certification authority and certification criteria.

## 3.0 Standard Operating Procedures

- 3.1 Identify procedures for entering and exiting the containment zone.
- 3.2 Provide applicable SOPs.
- 3.3 Identify maximum number of staff working within containment at any given time.

- 3.4 Personal protective equipment (PPE) requirements, locations for storing, donning and doffing of PPE, PPE decontamination methodology, location for powered air purifying respirators (PAPR) recharging.
- 3.5 Use and location of hand wash sinks.
- 3.6 Current or future requirements for showering out of containment.
- 3.7 Use and location of toilets (in or out of containment zone).
- 3.8 Requirements for unisex versus dedicated facilities.
- 3.9 Communication requirements during the entering/exiting process and operations inside containment.
- 3.10 Transfer of large equipment in and out of containment.
- 3.11 Emergency egress and first-response procedures.

## 4.0 Waste Management and Decontamination

- 4.1 Define methods for decontamination, transport, and disposal of liquid and solid waste.
- 4.2 Estimate likely waste volume and minimum sizes for autoclaves and other decontamination equipment.
- 4.3 Identify the method(s) for space decontamination, including typical time required for space decontamination.
- 4.4 Identify the method(s) for equipment decontamination and where large equipment will be decontaminated.
- 4.5 Define elements of the HVAC and other utility systems that may require decontamination and preferred method of decontamination.
- 4.6 If gas or vapor decontamination is required, verify types of equipment and/or systems to be used in this process.

## 5.0 Facility Maintenance

- 5.1 Identify methodology for servicing scientific equipment and utility system components that must be placed or used within the containment zone.
- 5.2 Identify standard operating procedures for facility shutdown and maintenance of the facility during shutdown. Determine if zoning is required to enable partial shutdowns.
- 5.3 Identify utility components serving the containment area that will require service access. Identify methodology for servicing components that may become contaminated.
- 5.4 Identify how infectious agents will be transported to and from the facility. Identify how agents will be transported within non-contained and public corridors.
- 5.5 Identify procedures for emergency egress and shutdown. Coordinate emergency procedures with local fire and rescue, emergency medical services, police, and health officials.

---

## 6.0 Technical Requirements

- 6.1 Identify how data and communications will be transmitted (fax, Wi-Fi, etc.). List laboratory services (i.e., gas, vacuum, air) required at the bench.
- 6.2 Identify requirements for hands-free communication and audio issues related to PAPR use.
- 6.3 Identify preference for hands-free sink operation.

---

## 7.0 Security Requirements

- 7.1 Identify access control for building, containment facility, containment zone, and any other security zones within the facility.
- 7.2 Define forced-entry protection requirements.
- 7.3 Define closed-circuit television monitoring requirements.

- 7.4 Define biometric security requirements.
- 7.5 Define agent storage security requirements.
- 7.6 Define data and communications security requirements.
- 7.7 Identify facility hardening and critical utility requirements.

---

## 8.0 Proposed Project Site

- 8.1 Verify that the proposed site can meet limitations that may be imposed by threat/risk criteria.

---

## 9.0 Electrical Requirements

- 9.1 Are any biocontainment areas considered as wet or damp locations?
- 9.2 Identify any special or unusual lighting requirements.
- 9.3 Identify any task lighting requirements (noting that this will reduce overhead ambient lighting due to lighting energy density concerns).
- 9.4 Identify any special lighting controls requirements.
- 9.5 Identify any higher densities of standard 120V receptacles requirements other than normally provided.
- 9.6 Other than standard 120V receptacles, identify other specialty electrical wiring devices or other utilization voltages requirements.
- 9.7 Identify any laboratory equipment requiring emergency power (if available) (noting that emergency power will be affected by more outages due to routine emergency distribution system testing).
- 9.8 Identify any special grounding requirements.
- 9.9 Identify any conditioned power requirements.
- 9.10 Identify any special magnetic area concerns.
- 9.11 Identify any special RF/EMI shielding requirements.

- 9.12 Identify any scientific equipment monitoring requirements.
- 9.13 Identify any special telecommunications requirements.

---

## ABSL-3 Research Animal Facilities

---

### 1.0 Program Requirements

- 1.1 Identify requirements and methodology for aerobiology.
- 1.2 Identify requirements for compartmentalization of different areas within the ABSL-3 biocontainment zone.
- 1.3 Identify requirements for proximity between ABSL-3 research animal holding and procedure rooms.
- 1.4 Identify each population of animals to be housed (species, number, health status) and potential for additional or different animal models in the future.

---

### 2.0 Regulatory Requirements

- 2.1 Specify if any select or agricultural agents are to be used.
- 2.2 Identify regulatory requirements related to the agents to be utilized.
- 2.3 Verify that a risk assessment has been completed, and identify provisions of the assessment that may affect facilities, standard operating procedures, and engineering controls.
- 2.4 Identify certification authority and certification criteria.

### 3.0 Standard Operating Procedures

- 3.1 Identify procedures for entering and exiting the ABSL-3 containment zone and individual suites or rooms within the containment zone.
- 3.2 Define maximum number of staff working within containment at any given time.
- 3.3 Identify personal protective equipment (PPE) requirements, locations for storing, donning and doffing of PPE, PPE decontamination methodology, location for powered air purifying respirators (PAPR) recharging.
- 3.4 Identify use and location of hand wash sinks.
- 3.5 Define current or future requirements for showing out of containment.
- 3.6 Identify use and location of toilets (in or out of containment zone).
- 3.7 Identify requirements for unisex versus dedicated facilities.
- 3.8 Identify communication requirements during the entering/exiting process.
- 3.9 Define methods of transfer of large equipment in and out of containment.
- 3.10 Identify emergency egress and first-response procedures.
- 3.11 Identify the procedures for cleaning, and the location of cleaning supplies and equipment.

---

### 4.0 Waste Management and Decontamination

- 4.1 Define methods for decontamination, transport, and disposal of liquid and solid waste.
- 4.2 Estimate likely waste volume and minimum sizes for autoclaves and other decontamination equipment.

- 4.3 Identify the method(s) for space decontamination, including typical time periods required for space decontamination.
- 4.4 Identify the method(s) for cage and equipment decontamination and where large equipment will be decontaminated.
- 4.5 Define elements of the HVAC and other utility systems that may require decontamination, and preferred method of decontamination.
- 4.6 If gas or vapor decontamination is required, verify types of equipment and/or systems to be used in this process.
- 4.7 Identify requirements and methodology for carcass decontamination, storage and disposal.

---

## 5.0 Cage Processing

- 5.1 Specify animal caging types (isolators, ventilated caging, conventional caging).
- 5.2 Identify requirements for in-place and/or centralized decontamination of caging.
- 5.3 Identify throughput requirements for caging decontamination as well as minimum chamber sizes if caging is autoclaved.
- 5.4 Define need and methodology for decontamination of waste water if room wash down is required.
- 5.5 Identify if any select or agricultural agents are to be used.

---

## 6.0 Animal Transport

- 6.1 Identify how animals will be transferred into the facility, and how infected animals will be transported within the containment area.
- 6.2 For larger animals, assess requirements for using track lifts/hoists for lifting and positioning animals for removal/radiography, etc.

- 6.3 Identify physical barriers to using track lifts/hoist

---

## 7.0 Security Requirements

- 7.1 Identify access control for building, containment facility, containment zone, and any other security zones within the facility.
- 7.1 Define forced entry protection requirements.
- 7.2 Define closed-circuit television monitoring requirements.
- 7.3 Define biometric security requirements.
- 7.4 Define agent storage security requirements.
- 7.5 Define data and communications security requirements.

---

## 8.0 Proposed Project Site

- 8.1 Verify that the proposed site can meet limitations that may be imposed by threat/risk criteria.

---

## 9.0 Electrical Requirements

- 9.1 Identify any special lighting requirements other than standard fluorescent lamp sources.
- 9.2 Is any permanently installed exam lighting required, and in which locations?
- 9.3 Identify any special lighting controls required other than user adjustable standard animal holding diurnal cycle with caretaker overrides.
- 9.4 Identify any higher densities of standard 120V receptacles required other than normally provided.
- 9.5 Other than standard 120V receptacles, identify any other specialty electrical wiring devices or other utilization voltages.

- 9.6 Identify any laboratory equipment requiring emergency power (if available) (noting that emergency power will be affected by more outages due to routine emergency distribution system testing).
- 9.7 Identify any special grounding requirements.
- 9.8 Identify any conditioned power requirements.
- 9.9 Identify any special magnetic area requirements.
- 9.10 Identify any special RF/EMI shielding requirements.
- 9.11 Identify any scientific equipment monitoring requirements.
- 9.12 Identify any special telecommunications requirements.



# Chapter 3

---

## Civil Engineering & Site Development

# Section 3.1

## Site Civil Design

---

### Contents

**3.1.0 Introduction**

**3.1.1 Codes and Standards**

**3.1.2 Design Documentation**

### 3.1.0 Introduction

NIH facilities are developed to provide environments conducive to the pursuit of research. An important part of this environment is the attractive, landscaped, pedestrian-friendly campus settings that meet environmental and regulatory requirements and support NIH's mission. The important research conducted at NIH requires that buildings and support facilities are constructed to the highest standards; design focus should be on maintainability and longer life spans to minimize disruption caused by repair and reconstruction.

### 3.1.1 Codes and Standards

Architectural/Engineering (A/E) services shall use and comply with the design and safety guidelines and references listed in [Section 1.2 Referenced Codes, Standards, and Organizations](#) in addition to other safety guidelines received from the project officer (PO), as required by the program, or as specified within individual sections of the *DRM*. The A/E shall utilize the latest editions of reference design and safety guidelines available at the time of the design contract award.

**A. Master Plans:** The following plans shall be followed for all new buildings, building additions, and utility/infrastructure projects on NIH campuses.

1. NIH Campus Master Plans
2. NIH Master Utility Plans

In general, good planning and design goals and principles shall be followed:

1. Preserving existing natural features such as vegetation, slopes, and drainage characteristics whenever possible
2. Protecting trees from construction stress and injury. Tree protection plans shall be developed and implemented by a certified arborist
3. Preserving and reinforcing sight lines and views, open space, building massing, historic resources, and other master plan features

4. Providing vehicular/pedestrian access that blends with the existing traffic pattern
5. Providing access for emergency vehicles
6. Providing safe, convenient, Architectural Barriers Act Accessibility Standard (ABAAS)-compliant pedestrian circulation and access to all points on campus
7. Phasing construction projects that impact day-to-day NIH activities to minimize disruption to the campus and maintain a safe environment for staff and visitors
8. Identifying contractor staging areas and space provided for contractor parking, trailers (including storage, materials, and office), dumpsters, cranes, delivery vehicles, maneuvering, and other site-specific factors

**B. Publication:** American Society of Civil Engineers publications provide the de facto project standards regarding civil engineering.

**C. Local Requirements:** The following standards shall be followed when constructing new structures on NIH campuses located in Montgomery County, Maryland:

1. Maryland Department of Transportation State Highway Administration standard details for installation of storm drains
2. Washington Suburban Sanitary Commission (WSSC) for installation of domestic water and sanitary sewer
3. Montgomery County Department of Transportation standard details for roadways, for installation of roadways, parking, and miscellaneous appurtenances
4. Maryland Department of Environment (MDE) standard details for sediment control and stormwater management
5. The Federal Emergency Management Agency (FEMA) for flood plain studies and analysis

## 3.1.2 Design Documentation

The A/E shall submit drawings, specifications, Basis of Design (BOD), cost estimates, and calculations at different stages of a project. Refer to [Section 1.5 Project Design Review](#) and [Appendix E: A/E Submission Requirements](#) for documentation requirements at the completion of each stage. All documents provided by NIH, including the NIH Master Utility File, shall be used for reference and general information only. The A/E or construction contractor shall field verify all items within the limits of a project. Verification shall include utility surveys, test pits, topographical surveys and other investigations as required to accurately determine depths, sizes, materials, and other pertinent information for all utilities. In addition, provide the following documentation:

**A. Cover Sheet:** The cover sheet shall include the Vicinity Map (1 inch = 1000 feet), Complete Campus Map with street and building names along with the project area indicated, project name, building name/number, index of sheets, benchmark list, and the A/E firm names and addresses.

**B. Proposed Site Plan:** The site plan shall clearly indicate the limits of disturbance (LOD); the project or site utilization area must be indicated within the LOD. The LOD will be used as limits during construction for elements including but not limited to trailers, equipment, vehicle and pedestrian traffic control, parking, material storage, and tree protections. The proposed site plan must also indicate existing and proposed topographic benchmarks, proposed features, and roads/sidewalks. In addition, it must indicate trees, underground utilities, and building footprints (labeled).

**C. Existing Condition Site Plan:** This plan shall indicate all existing structures, underground utilities, grade elevations, benchmarks, coordinates, building footprints, streets, and other items, labeled accordingly. The A/E shall indicate locations and project area clearly.

**D. Site Development Plan:** The Site Development Plan shall indicate existing topography, benchmarks, major site features, relationship to roads/walks, trees, and the proposed building footprint.

**E. Sediment and Erosion Control Plan:** Plans and details showing erosion control measurements shall be developed according to the Maryland Standards and Specifications for Soil Erosion and Sediment Control.

**F. Site Utility Plans:** Plans, profiles, details, schedules, etc. based on existing topography referencing project benchmarks and utility surveys. These documents shall include, but not necessarily be limited to, the locations of all utilities above and below ground, manholes with invert elevations, transformer pads, electrical poles, meters, vaults, building(s), roads, service areas, major site features, easements and other legal constraints, setbacks, etc.

**G. Storm Water Plans:** Plans, profiles, pipe crossing clearances, pipe covers, storm and inlet computations, structure schedules, and all other pertinent information, based on existing topography referencing project benchmarks. Plans shall include, but not necessarily be limited to, storm water improvements such as swales, berms, ditches, culverts, storm drains, storm water inlets, etc.

**H. Site Improvement Plans:** Plans and details showing, but not necessarily limited to, the locations of building(s), roads, and service areas.

**I. Landscape Plans:** Plans, schedules, and details showing, but not necessarily limited to, the location of buildings, roads, service areas, walks, plazas, natural areas, existing vegetation, etc.

**J. Outline Specifications:** Outline specifications shall be developed at the design development stage.

**K. Detail Performance Specifications:** Detail performance specifications shall be developed at the contract document stage.

**L. Systems Cost Estimates:** Systems cost estimates shall be developed at the design development stage.

**M. Quantity Takeoff Estimates:** Quantity takeoff estimates shall be developed at the contract document stage.

# Section 3.2

## Site Development

---

### Contents

3.2.0 Introduction

3.2.1 Site Development Design

3.2.2 Local Requirements

## 3.2.0 Introduction

Site development design is critical to the campus and environment. The following design requirements apply to site development design.

### 3.2.1 Site Development Design

**A. Grading:** Proposed grading plans shall be coordinated with the Office of Research Facilities (ORF) Development and Operations. Maximum slopes on lawn areas shall be 3:1. Slopes steeper than 3:1 shall be planted and mulched. Retaining walls should be used when applicable to help mitigate steep slope conditions and should have safety provisions for fall protection when there is a walkway on the high side. Slopes, cross-slope, handrails, and other parameters of sidewalks and ramps shall be compliant with the latest ABAAS requirements. When adjacent to buildings, paving should ideally be sloped between 1.5%–2.5% for balancing functionality and aesthetics. For lawn areas, the minimum slope shall be 5% for the first 5 feet from the building and 2% after that.

**B. Stockpiling:** Stockpiling is strongly discouraged; however, it may occur on a project-by-project basis if in compliance with all the following conditions:

1. Prior approval from the Division of Environmental Protection (DEP)
2. Excavated material quantities are less than 76 m<sup>3</sup> (100 yd<sup>3</sup>)
3. Excavated material stored within the limits of disturbance (LOD)

**C. Sediment and Erosion Control:** Sediment and erosion control (SEC) drawings shall be prepared for construction that results in ground disturbance, as required by current MDE standards and requirements or appropriate state or local jurisdictions. Any construction that results in ground disturbance shall be subject to the NIH SEC protection policy on a project-specific basis. The PO shall contact the DEP for specific guidance. The A/E shall prepare SEC permit drawings and submit to DEP through the PO for review and MDE submissions.

***Rationale:** The purpose of sediment and erosion control is to keep sediments, construction debris and pollutants within the limit of disturbance. Runoff from the construction site requires minimum treatment to prevent it from contaminating the surrounded areas and streams or clogging adjacent storm water inlets.*

**D. Storm Water Management:** All drainage systems that collect runoff from parking areas shall be provided with appropriate exterior-type oil and sand interceptors to serve segregated waste streams for specific functions as necessary to ensure compliance with the Environmental Protection Agency (EPA) discharge regulations. This will help maintain proper water quality and minimize potential maintenance issues for NIH campus infrastructure. Drainage from intermediate parking garage levels shall discharge to the sanitary system through an appropriate oil/sand interceptor. Only the top deck, exposed to rainfall, may discharge to the storm water system. Refer to [Section 8.4 Drainage Systems](#) for additional requirements.

### 3.2.2 Local Requirements

**A. Sediment and Erosion Control:** For NIH projects located in Maryland, an MDE permit for SEC is required when a project nears or exceeds the MDE threshold, defined as a disturbance of 465 m<sup>2</sup> (5,000 ft<sup>2</sup>) of existing ground or the movement of 76 m<sup>3</sup> (100 yd<sup>3</sup>) of soil. SEC projects with greater than 4,047 m<sup>2</sup> (43,560 ft<sup>2</sup>) of disturbance shall comply with MDE General Permit Number 97-GP-0004, which requires additional inspections. Additional fees, record-keeping, and other requirements may also apply. In addition, projects shall comply with the following requirements:

1. For projects on the Bethesda and Poolesville campuses, all submittals prepared by the A/Es to the MDE for state plan review and approval must be submitted to the DEP.
2. It is highly recommended that an MDE review be made through an MDE-approved “expedited” reviewer. When a permit is required, no site work shall commence prior to holding an SEC preconstruction meeting with the MDE



inspector. When a permit is not required, the installation of SEC required by DEP shall be in place before site work begins.

**B. Storm Water Management:** All construction shall meet the requirements of the MDE.

# Section 3.3

## Site Utilities

---

### Contents

**3.3.0 Introduction**

**3.3.1 Utility Piping Standards**

**3.3.2 Site Utilities Design Requirements**

**3.3.3 Identification of Underground Utilities**

**3.3.4 Local Requirements**

**3.3.5 Additional Water Systems Requirements**

**3.3.6 Additional Gravity Sewer Requirements**

### 3.3.0 Introduction

Site utilities are vital for the distribution of steam, chilled water, storm and sanitary sewer lines, and other services necessary for the operation of NIH facilities.

### 3.3.1 Utility Piping Standards

In addition to the requirements of [3.1.1 Codes and Standards](#), piping design and installation shall comply with the recommendations of the National Association of Corrosion Engineers (NACE), American Society of Civil Engineers (ASCE), relevant standards of ASTM and ANSI, and AWWA, along with relevant recommendations of the American Concrete Pipe Association (Concrete Pipe Design Manual), the National Clay Pipe Institute (NCPI), the Ductile Iron Pipe Research Association (DIPRA), and the Plastic Pipe Institute (PPI) as applicable to the specific material and application. Additionally, comply with recommendations of “Conduits, Culverts, and Pipes” by the U.S. Army Corps of Engineers and “Designing and Avoiding Odor and Corrosion in New Wastewater Collection Systems” by the United States Environmental Protection Agency (USEPA), as well as the requirements of the American Society of Mechanical Engineers (ASME) and applicable local utilities.

### 3.3.2 Site Utilities Design Requirements

**A. General Requirements:** Existing utilities shall be located by referencing the NIH Master Utility Plan. The Division of Facilities Planning (DFP) maintains the master plan for underground utility services for reference during the preparation of site design. Preliminary site work considerations shall include:

1. Acquiring services from a qualified geotechnical engineer licensed to practice in the state where work occurs. See [Section 5.1.9 Geotechnical Report](#).
2. Verifying locations of existing utilities with frequent test pits using vacuum dig techniques to avoid disruption to the campus.

3. Testing all existing underground steam and condensate piping (where possible) to be disturbed for asbestos-contaminated insulation.

Utility branch design for new facilities or renovations to existing facilities shall include complete utility service branch supply/return systems, including underground tunnels, vaults, trenches, duct banks, or routes through existing structures. The new branch designs shall be inclusive and extend from the new facility’s mechanical rooms to the existing supply source and include all required in-line monitoring and control devices. No structure may be constructed above underground utilities. Utility systems shall be relocated to areas that provide clear access for maintenance.

**B. Project Service Life:** The A/E shall select materials and design approaches with a useable service life of 75 to 100 years under reasonably anticipated applied conditions for the location of each installation.

**C. Reliability:** Utilities shall be arranged to ensure service continuity and reliability and to minimize the potential of plausible failure. Loop arrangements and similar redundancy shall be provided for all critical utilities. The redundancy method shall be documented in the Project BOD and reviewed and approved with the PO and utilities branch prior to design.

**D. Setbacks:** Utility pipelines shall be placed at sufficient setback distances from buildings to protect structures and occupants from damage or injury in the event of a piping system failure, including those which may occur from ancillary damage in the event of a pipe failure (e.g., pits, unstable earth, water damage, projected debris). Where pipelines cannot be placed at a sufficient distance, the A/E shall ensure the design and construction of the structure is adequate to prevent structural damage or injury in the event of a utility break or failure.

**E. Utility Location, Protection, and Damage Mitigation Plan:** Prior to any excavation, all utilities shall be reliably located and marked above ground, and all adjacent utilities and structures shall be properly protected. In addition, a damage mitigation and rapid restoration plan shall have been developed prior to the start of construction and shall be in place to immediately restore service (including provision of any required temporary utilities) in the event of damage or disruption associated with construction activities. Any construction activity which may be considered a risk to the operations of any

research or clinical facility, as well as any activity that is near any hazardous or critical piping or near to any critical utility, shall occur only upon approval of the risk and damage mitigation plan and schedule by the PO. The A/E shall specify for the contractor to develop an action plan to facilitate immediate restoration of service in the event of any breach prior to undertaking excavation activities and to outline and incorporate any other required mitigation of risks. This action plan shall include, but not be limited to, the availability of personnel, materials, and backfeed provisions; mitigation of potential safety issues; and in-place contact procedures and availability of facility and emergency response personnel in the event of an accident or unplanned damage.

**F. Utility Disruption and Restoration:** Utilities services to NIH facilities shall not be disrupted without written approval of the PO, which shall include the time of the disruption, the duration, and the time of restoration. The A/E shall specify that the contractor shall ensure the quality of utilities (e.g., free of contamination) prior to connection to existing buildings.

**G. Field Confirmation:** All branch utility connection points shall be field verified and validated during the project design phase by the A/E of record.

**H. Inspection and Testing:** All utilities and related aspects of construction shall be thoroughly inspected by a competent professional as approved by the NIH and tested to the same extent as required for local major municipality utilities and as additionally required by the NIH. Testing and inspection reports shall be submitted to the NIH. The A/E shall provide competent field personnel to oversee any test and inspection activities unless otherwise directed by the PO.

**I. Profiles:** Underground utilities design shall include profiles for all main lines and major laterals. Electrical duct bank profiles shall slope away from buildings to the first manhole. Cover shall be a minimum of 762 mm (2 ft. 6 in.) and sufficient to keep the utility line below the local frost line.

**J. Manholes:** Manholes shall be provided at all changes in direction on utility lines 203 mm (8 in.) and larger for storm and sanitary sewers and at all points of connection. NIH numbers shall be brazed on manhole covers.

**K. Required Corrosion Resistant Analysis, Design, and**

**Construction:** Pipelines shall be designed for corrosion resistance in conformance with the recommendations of the National Association of Corrosion Engineers (NACE). Designs shall include requirements for testing soil for stray currents as well as corrosivity. Cathodic protection of underground metallic piping is required. The evaluation shall ensure compatibility with system materials and shall consider resistivity, pH, oxidation-reduction potential, presence of sulfides, moisture content, presence of and potential for stray currents, known corrosivity, groundwater elevations, suspected corrosivity/chemicals/hydrocarbons, and experience with existing installations in the project area. For pipelines greater than or equal to 152 mm (6 in.) in diameter, the initial corrosion evaluation shall be made by a competent corrosion protection professional. Where cathodic protection systems are required, a predesign meeting with NIH is required. Cathodic Protection systems shall be designed by a corrosion engineer with NACE certification, or by a NACE certified Corrosion Specialist. All cathodic protection system installations shall be inspected and tested by a competent corrosion engineer, NACE certified Senior Corrosion Technologist, or NACE certified Corrosion Specialist. The corrosion professional shall provide a report of recommendations to the design team, which shall be included in the project BOD.

**L. Geotechnical Investigation:** Proper soil analysis is required for each underground installation, including an adequate number of soil borings and analysis by a licensed geotechnical engineer or as otherwise required to ensure proper design and installation.

**M. Excavation:** Excavation, backfill, support, dewatering, corrosion protection, and compaction requirements shall be specified in conformance with on-site geotechnical reports and recommendations of the geotechnical, civil, and corrosion engineer. The A/E shall carefully review geotechnical reports and specify materials and procedures to prevent loss of piping slope or alignment. Trenches shall not be subject to loading or water infiltration except as approved by the geotechnical engineer and shall not result in piping displacement. Excavation shall not be within a 45° angle of repose of the bottom of footings or foundations serving buildings, supports, or retaining walls. The A/E shall consider the required width of trenches when arranging piping networks and in some cases may need to coordinate with the

structural engineer to lower the bottom of certain footings to comply with this requirement.

A geotechnical report by a qualified design professional is required for all new and major projects where underground utilities will be buried, including within the building. The report shall address specific requirements for utilities, including but not limited to mitigation for soil corrosivity issues; protection of piping from corrosion-induced failure; groundwater, bedding, and compaction requirements; as well as any additional requirements unique to the project site to ensure safe, stable, and durable system installations. The report shall also address the need for underslab (subsoil) dewatering and foundation drainage and any additional design recommendations related to underground utilities that should be considered.

Excavation, backfill, and compaction (whether inside or outside the structure) shall be performed in accordance with requirements of the site-specific on-site geotechnical conditions at the project to maintain proper support and grade for piping installations and protect piping from superimposed loads (including construction traffic), groundwater, and corrosive conditions. Strict control of excavation, backfill, and compaction procedures shall be specified based on on-site conditions, loadings, and system materials.

The A/E shall specify compliance with on-site geotechnical requirements to address proper bedding and compaction for all underground plumbing and utilities in detail and shall not leave determinations up to the contractor. A competent design professional shall direct specifications for such activities as well as required quality control.

Specific attention to corrosion control; dewatering; *DRM* piping slopes; required bedding, backfill lifts, and compaction density; and protection from construction loads is mandatory and shall be addressed by the A/E and verified in construction.

**N. Shoring Systems for Site Utilities:** Because vibration transmission adversely affects research, impact-driven shoring systems may not be used, unless the contract specifically states this system may be used. Refer to [Section 6.5: Noise and Vibration](#).

**O. Utility Connections:** All planned connections to the

central utility systems and revisions to the NIH piping or electrical distribution networks shall be reviewed and approved by the NIH Utility Distribution Branch (UDB) for compliance with NIH requirements. The applicable systems include all utility distribution systems; return systems for steam/condensate; electrical, information technology/local area network (IT/LAN), chilled water supply/return, compressed air, potable water, natural gas, and storm and sanitary sewer lines. This also encompasses campus utility distribution lines (not building service connections) that traverse basements, crawl spaces, mechanical or electric rooms, and interstitial space or go under foundations or over structures.

**P. Benchmark:** Indicate the benchmark from which all elevations will be measured. Identify United States Geological Survey (USGS) Datum being observed.

**Q. Sizing:** Utilities shall be sized to allow for the projected loads of master plans, any additional requirements of other engineering sections of the *DRM*, and at least 20% overage for mains and building services. In addition, utility design shall comply with any velocity requirements of this section and additional requirements stated in related engineering sections of the *DRM*.

**R. Quality Control and Assurance:** Ensure proper grade, bedding, compaction, and backfill of lines in accordance with requirements of the *DRM* and on-site geotechnical conditions and in compliance with required procedures to protect and maintain piping grade and preclude displacement or stresses of underground lines. An appropriate quality-control plan is mandatory, including coordination with the geotechnical, civil, and corrosion engineer or other individuals providing such construction oversight.

**S. Pipeline Stress/Flexibility Analysis:** The A/E shall justify the design approach by providing appropriate calculations and demonstrating an appropriate design for pipeline thermal conditions for HVAC systems (e.g., steam, high temperature water).

**T. Direct Buried Insulated Systems:** Direct buried insulated piping systems are not normally permitted; their use requires justification and pre-approval, including materials analysis and a rigorous construction quality assurance plan. Insulated piping should be installed in

tunnels or as otherwise approved by NIH.

**U. Materials:** Refer to [Exhibit 6.3](#) within Chapter 6 for detailed criteria for materials, applications, and joints, which are to be utilized for site utility services.

**V. Required Computer Modeling:** The NIH has developed extensive computer modeling for existing utilities. Expansion of these utilities requires the use of the programs listed in [Table 3.3.2](#) for analysis.

**Table 3.3.2 Required Computer Modeling Programs**

Storm Drain	EDS Storm Drain
Sanitary sewer	EDS Sewer
Domestic water	KY Pipe
Chilled water	KY Pipe
Steam	Steamnet
Other	No standard

### 3.3.3 Identification of Underground Utilities

For all new, repaired, or altered underground utilities greater than 3 m (10 ft.) in length, the contractor shall install detectable marking tape 203 mm (8 in.) below grade, unless otherwise directed by the engineer or Project Officer.

Detectable marking tape shall be permanent, appropriately colored, continuous-printed magnetic tape intended for direct-burial service not less than 152 mm (6 in.) wide by 4 mils thick. The tape shall read “CAUTION: BURIED INSTALLATION BELOW”.

Tape color shall conform to the American Public Works Association (APWA) Uniform Color Code.

All non-electrically conductive buried piping systems outside of buildings shall be provided with polyethylene-insulated copper tracer wire suitable for burial, minimum #12 AWG. All hazardous piping, flammable

piping, and piping carrying oxidizers shall be fitted with tracing wire where buried, regardless of whether they were fitted in containment. The tracer wire shall be laid above the piping centerline within 152 mm (6 in.) of the piping top, shall have no joints, and shall not be wrapped around the piping except at the accessible riser. Tracer wire shall terminate at ground rods and be joined to other systems with manufactured direct-bury sealed splice kits designed for the application. In addition, metal warning detection tape shall be installed 305 mm (1 ft.) above the piping during backfill.

**A. Uniform Color Code:** The APWA encourages public agencies, utilities, contractors, manufacturers, other associations, and all others involved in excavation to adopt the APWA Uniform Color Code, using ANSI standard Z535.1 Safety Colors for temporary marking and facility identification.

WHITE – Proposed Excavation

PINK – Temporary Survey Markings

RED – Electric Power Lines, Cables, Conduit and Lighting Cable

YELLOW – Gas, Oil, Steam, Petroleum or Gaseous Materials

ORANGE – Communication, Alarm or Signal Lines, Cables, or Conduit

BLUE – Potable Water

GREEN – Sewers and Drain Lines

PURPLE – Reclaimed Water, Irrigation, and Slurry Lines

**B. Submittals:** The contractor shall submit product data for approval prior to the start of any excavation activities. Contractors shall submit samples of each section of tape proposed on the project. Sample shall be a minimum length required to verify correct warning language, width, thickness, and material.



### 3.3.4 Local Requirements

**A. Local Municipality:** The *DRM* does not address all mandatory requirements for the design and installation of on-site utilities. The A/E shall comply with best practices and requirements of the nearest local major municipality and utility authorities in addition to any requirements in the *DRM* which may be more restrictive.

1. **Water and Sewer:** For projects at the NIH Bethesda and Poolesville Campuses, the design and installation of domestic water supply and sanitary sewer lines shall comply with all the WSSC requirements, general conditions, and standard specifications (except as otherwise noted in the *DRM*) and shall be identified clearly in applicable design drawings and specifications. Inspections shall be carried out by the responsible design A/E and their consultants. The A/E shall notify NIH DEP upon completion (as well as completion of any additional inspections by NIH, as needed) unless otherwise approved by NIH. Plans are submitted to NIH for review and approval.

**B. Natural Gas:** Utility piping systems located on the NIH campus for natural gas service shall comply with all requirements of the Washington Gas Company and the Code of Federal Regulations. Natural gas piping shall conform to ASTM D2513.

**C. Compressed Air:** New compressed air piping installed as part of the campus distribution system (excluding piping in a building interior) shall be plastic pipe conforming to ASTM D3035.

**D. Stormwater:** Stormwater design practices shall comply with the requirements of the Maryland Department of the Environment (MDE), the NIH Master Plan for Stormwater Management, and the Code of Federal Regulations. Technical details not covered in the above sources shall follow best practices of the local major municipalities and requirements as issued by NIH.

### 3.3.5 Additional Water Systems Requirements

**A.** Comply with requirements of the most current WSSC Pipeline Design Manual.

**B.** Water systems shall be arranged on a grid basis with valving to permit bidirectional flow and to maximize service continuity to each facility.

**C.** Thrust blocking is required, along with joint restraints, and shall be arranged for effective use under conditions of bidirectional flow. Thrust blocks shall be poured against undisturbed soil and inspected prior to backfill.

**D.** All water systems shall be properly tested, flushed, and disinfected in accordance with AWWA guidelines.

**E.** Individual water services shall be provided for each building. Comply with water service requirements in [Section 8.3 Water Systems](#).

**F.** Corrosion protection shall be in accordance with the WSSC Pipeline Design Manual, Part 3 Common Design Guidelines or in conformance with approved recommendations of a competent corrosion engineer. The exception is that requirements for coating and cathodic corrosion protection (as determined by corrosion potential analysis) shall apply to all pipe sizes, including piping 406 mm (1 ft. 4 in.) and smaller.

### 3.3.6 Additional Gravity Sewer Requirements

**A.** Combined sewers are not permitted.

**B.** The minimum size sewer lateral for any building shall be 152 mm (6 in.). Individual sewer laterals are required for each building. Coordinate sewer elevations with the A/E and design them to prevent backwater flooding within any building, including under any condition of full sewer flow.

**C.** Gravity sewers shall be designed to carry the calculated peak design flow at a minimum velocity of 0.76 m/s (2.5 fps) (based upon flow not to exceed 1/4 full)

and a maximum velocity not to exceed 3.04 m/s (10 fps) (at the peak design flow). Where there is inadequate flow to achieve minimum flow (such as at some terminal buildings), provide a minimum slope of at least 1%. Storm sewers shall be designed for 0.91 to 3.04 m/s (3 to 10 fps) velocity. Systems shall be designed to not surcharge manholes.

D. Materials shall be corrosion-resistant and designed to minimize potential for stoppages. Systems shall be water- and gas-tight and tight against tree-root infiltration.

E. Maximum long-term deflection in gravity sewer lines shall not exceed requirements allowable by WSSC, but in no case exceed 4%. Initial deflection shall be calculated, and vertical ring deflection shall be measured in each plastic pipe section no sooner than 30 days after final trench backfill to grade. Proper alignment, slope, thrust restraint, and backfill criteria shall be rigidly specified and monitored. Utility systems shall bear at least 610 mm (2 ft.) depth of soil, compacted to its optimum moisture content, as certified by written recordings performed by or under the supervision of a registered professional geotechnical engineer, based on samples taken at the location where the work is performed.

F. Corrosion protection shall be in accordance with WSSC Pipeline Design Manual, Part 3 Common Design Guidelines or in conformance with the approved recommendations of a corrosion engineer, except that requirements for coating and cathodic corrosion protection (as determined by corrosion potential analysis) shall apply to all pipe sizes, including piping 406 mm (1 ft. 4 in.) and smaller.

# Section 3.4

## Site Improvements

---

### Contents

3.4.0 Introduction

3.4.1 Site Improvement Requirements

3.4.2 Local Requirements

## 3.4.0 Introduction

Site improvements, including roads and parking lots, sidewalks, and other constructed site elements, are important for the safe and smooth flow of people and vehicles on NIH campuses.

### 3.4.1 Site Improvement Requirements

**A. General Requirements:** Borings and geotechnical reports should be obtained from a qualified geotechnical consultant licensed to practice in the state where the work is to be implemented. The report should include a preliminary recommendation for sheeting and shoring. All existing underground steam and condensate piping that will be disturbed should be tested for insulation containing asbestos. Existing natural features such as trees, slopes, and drainage characteristics should be preserved and/or restored to previous conditions whenever possible. The construction of large and significant projects that impact day-to-day NIH activities should be phased to minimize disruption to the campus.

Contractor staging areas should be identified as early in the project as possible and reasonable space should be provided. All temporary fencing shall withstand a wind load of 3.0 kgf/m<sup>2</sup> (20 psf), with a 1.5 overturning factor of safety.

**Table 3.4.1 Pavement Composition**

Area	Item	Paving Section
Parking Lot	Subbase	Compacted soil
	Base	One lift of 102 mm (4 in.) compacted base
	Bituminous concrete	51 mm (2 in.) compacted topping
Roadways	Subbase	Compacted soil
	Base	Two lifts of 102 mm (4 in.) compacted base
	Bituminous concrete	51 mm (2 in.) compacted topping

**B. Parking and Paving:** The size and types of parking spaces should be in conformance with local zoning regulations. Handicapped spaces should be adjacent to buildings whenever possible and located on an accessible route. Paving composition shall be as noted in [Table 3.4.1](#). All pavement shall be designed by a registered geotechnical or civil engineer. Parking lots should slope 1% minimum and 5% maximum.

- 1. Traffic Line Striping for Roads and Parking Lots:** Paint shall be approved lead-free, volatile organic compound compliant, fast-drying, and 100% acrylic waterborne traffic paint. A manufacturer's safety data sheet (MSDS) shall be submitted for each product. White traffic paint shall be a premium grade with 78% total solids by weight and containing additional resin and titanium dioxide. Painting shall only be allowed when pavement surfaces are dry and clean. Pavement surface temperatures shall be at or above 5° C (41° F) and rising. Wet film thickness shall be 0.30–0.38 mm (12–15 mils). New striping shall match existing line widths with no line being less than 102 mm (4 in.) wide.
- 2. Strong yellow-green crosswalk tape** shall be thermoplastic marking tape. Where required, this heat-applied product shall be installed strictly following manufacturer's recommendations. Tape shall be alternating 203 mm (8 in.) minimum lengths of 203 mm (8 in.) wide strong yellow-green and 305 mm (1 ft.) wide white. There shall be a 152 mm (6 in.) gap between tape strips. Other crosswalks shall be painted white.

**C. Sidewalks, Curbs, and Gutters:** Optimum sidewalk width is 1.8 m (6 ft.), with 1.5 m (5 ft.) as the minimum. The sidewalk concrete design mix shall be a minimum of 102 mm (4 in.), 31 MPa (4,500 psi), 6% to 8% air entrainment. Mix iron oxide color pigment per the manufacturer's direction and seal with a clear curing compound. Color additive shall be similar to Silversmoke by Artevia. Contact DFS for color approval. Finished surfaces shall have a medium texture broom finish perpendicular to the path of travel for maximum slip resistance. Detectable warning surfaces shall be cast-in-place, replaceable, tactile pavers approved by the ADRB.

1. **Material Exclusions for Curbs and Curb Gutters:** Granite curbs are not permitted on any NIH projects.
2. **Material Exclusions for Common Pedestrian Sidewalk Areas Subject to Use by Snow Removal Equipment:** The following materials are not permitted on any NIH projects because of maintenance requirements or safety concerns:
  - a. Cobblestones
  - b. Asphalt hex pavers on asphalt base
  - c. Exposed aggregate concrete
  - d. Any type of paver material on gravel/sand base course
  - e. Pavers on pedestal systems
  - f. Granite, brick, or slate on concrete base
  - g. Stamped concrete

**D. Loading Docks, and Delivery and Service Areas:** All new campus buildings and buildings subject to major retrofitting require the installation of loading docks. Loading docks are a functional extension of the facility and should be designed and managed to facilitate proper and efficient movement of materials into and out of the facility along with a dockyard that is easily cleaned and maintained. Loading docks should be located in areas of the building that are separate from normal daily pedestrian and vehicular traffic and should be sized for safe maneuvering and loading and unloading equipment such as pallet trucks.

Loading docks should be sited to prevent the entry of pests and designed to create an effective barrier between the outside of the facility and the interior. Current and future facility needs should be taken into consideration when planning and designing allocated space for loading docks. Facilities expand, needs change, and docks should be conceived with long term viability in mind.

For additional loading dock requirements, refer to [Section 4.8 Loading Docks](#).

1. **Access and Truck Size:** Access to loading docks will be directly from NIH campus roads. No access through parking lots will be permitted. Roadways leading to loading docks should be

of sufficient size and configuration to accommodate various sized vehicles up to and including tractor trailer class.

2. **Drainage and Grading:** Adequate drainage should be provided by use of trench drains or positive drainage away from the dock, with a minimum gradient of 1:100.

**E. Parking and Wheel Stops:** Tarmacs on-grade must have wheel stops available that meet Occupational Safety and Health Administration requirements. Adequate short-term parking should be available for courier service vehicles.

**F. Snow Removal Areas:** Areas for piling snow from snow removal operations are desirable and should not block the dumpster or the loading dock. Heated pavement is not permitted for snow removal due to maintenance and energy concerns. The contractor should contact the NIH Landscape Architect during the selection of designated areas.

**G. Screening:** Visual screening of all loading areas is desirable to minimize audible and visible disruption to the NIH campuses and surrounding communities. Evergreen plant material around loading docks should visually screen while also meeting pest control IPM requirements in [Section 1.12 Integrated Pest Management](#). Screening should be carefully coordinated with the Division of Physical Security Management (DPSM) and closed-circuit television requirements.

**H. Fences:** Staging areas shall be surrounded by a temporary 2.4 m (8 ft.) chain-link fence with brown plastic screening material. See [Section 3.4.1 A. General Requirements](#) for wind loading and overturning requirements. Solid wood fencing shall be provided where possible pedestrian hazards may occur. Permanent decorative fencing shall be located and designed in accordance with the NIH Campus Master Plans and under the review and approval of the NIH Architectural Design Review Board (ADRB). All critical exterior utility equipment, including but not limited to generators, transformers, air handling units, etc., require permanent security fencing. Security fencing shall meet the requirements set forth by DPSM.

**I. Site Furnishing:** Furnishing shall be used for a variety of purposes. Benches should be located periodically along long pedestrian circulation corridors to create

rest points. They can also be integrated into the design of plazas and garden spaces. Tables and chairs should be specified in areas where eating and/or outdoor work environments are envisioned. Bicycle racks should be located close to building entries without obstructing pathways or views. There should be low plantings around bike rack areas for screening, especially in public areas. The number of bicycle racks should be factored according to the number of anticipated building users. Lastly, shade devices such as umbrellas and treillage should be used anywhere that natural tree cover cannot be established for shade. All site furnishing should be constructed of high-quality materials requiring little to no maintenance. Preferred materials include stainless steel, anodized aluminum, powder-coated steel, high performance plastics, and rot-resistant hardwood.

---

### **3.4.2 Local Requirements**

Parking for vehicles shall be coordinated through the NIH.



# Section 3.5

## Landscaping

---

### Contents

**3.5.0 Introduction**

**3.5.1 New Plantings**

**3.5.2 Landscape Maintenance and Pest Management**

**3.5.3 Plant Removal and Replacement**

**3.5.4 Campus Trees**

## 3.5.0 Introduction

Landscaping is an important aspect of NIH facilities because it both impacts the visual appeal of the campuses and supports native species and ecosystems.

The overall site design shall be coordinated with the ORF landscape architect during the early design stages. In all cases, designs should strive to achieve exterior placemaking goals without compromising functionality. Pedestrian circulation should be clear and straightforward and should avoid direct conflict with vehicular circulation patterns to ensure safety on campus. Programmatic needs for outdoor working environments, rest areas, eating areas, and larger gathering spaces should be developed with building projects as appropriate.

### 3.5.1 New Plantings

For all project plantings, select species that are native, drought-tolerant, and deer-resistant. Non-invasive adapted and exotic plants can be used as accents and/or in difficult landscape conditions as approved by the ORF Landscape Architect. Invasive exotic species are prohibited in new plantings. Projects with existing invasive species within the limits of disturbance should make provisions for removal as part of the project. Plants adjacent to sidewalks, roads, and parking lot areas should also exhibit moderate to high salt tolerance and not drop messy seeds or fruit.

New plantings must meet the following requirements:

1. Deciduous trees shall be a minimum of 51 mm (2 in.) caliper, evergreens shall be a minimum of 2.4 m (8 ft.) in height, and ornamental or understory trees shall be a minimum of 2.4 m (8 ft.) in height. All new trees should be installed with deer protection for their trunks. Acceptable types of protection include galvanized hardware cloth and rigid plastic mesh columns offset at least 51 mm (2 in.) from the edge of bark. Opaque tree wraps are not permitted.

2. Shrubs shall range between 610 mm (2 ft.) and 762 mm (2 ft-6 in) in crown width. Herbaceous perennials and ornamental grasses shall be 1-gallon container minimum. Shrubs and herbaceous groundcovers shall not be spaced according to their full anticipated spread, but rather spaced closer together so that they provide full bed coverage within four years of planting.
3. Slopes steeper than 3:1 must be planted with groundcover or shrub masses. All disturbed areas with a slope of 3:1 or shallower that are not paved or landscaped shall be restored with state- or local jurisdiction-approved seed or sod on a minimum 102 mm (4 in.) of topsoil. Poorly rooted sod with nylon mesh backing is prohibited.

All proposed plantings need to be graphically shown on plan drawings with a plant quantity and species key; the plan drawing must correspond to an overall planting schedule. Planting schedules should be categorized by plant type (i.e., trees, shrubs, perennials/grasses, groundcovers) and organized in alphabetical order by botanical name. A sample tree planting schedule can be found in [Exhibit 3.2 Sample Tree Replacement Calculation Charts](#), which can be used for all plant type categories. At minimum, plant schedules should contain the following information in table format:

- Quantity
- Key
- Botanical Name (Latin Name)
- Common Name
- Size
- Stock
- Spacing

The NIH has several campuses throughout the United States. It is recommended that NIH facilities programs use the U.S. Department of Agriculture's (USDA's) Plant Hardiness Maps to determine which plants are suitable for their campuses. NIH campuses located in Maryland are in Zones 6 (Frederick) and 7 (Bethesda, Poolesville, and Baltimore). NIH campuses located in North Carolina are in Zone 7. NIH campuses located in Montana are in Zone 5.

## 3.5.2 Landscape Maintenance and Pest Management

An open gravel boundary strip around the extent of buildings is required for landscape maintenance. This maintenance strip shall be 610 mm (2 ft.) wide by 102 mm (4 in.) deep and filled with egg-sized, washed river stones with non-woven geotextile soil separation fabric. A maintenance strip shall be provided around all new or newly landscaped buildings for landscape maintenance and pest management. Aluminum or steel edging shall be used around the maintenance strip, and the geotextile fabric should be hidden from view. The strip shall be wide enough to facilitate inspections around the building, shall be constructed from durable materials, shall not obstruct grass-cutting or maintenance activities, and shall prevent encroachment of grasses or weeds around the exterior of the building. This maintenance strip should be graphically shown on site drawings.

All planting beds shall begin outside the maintenance strip. Mulches shall be double-shredded hardwood, cypress mulch, or pine bark fines. Mulch shall be applied to a compacted depth of 76 mm (3 in.). Mulches should not be mounded in planting areas and should not touch shrub or tree trunks.

Landscape planting impacts the number and types of pests found around the exterior of the building, as well as within the building envelope. The following shall not be used in NIH projects:

1. Ornamental plants notorious for insect infestation (such as Ash, Mulberry, Boxelder, and Spirea), which attract pests that can become indoor problems
2. Dense foundation plantings, which reduce air circulation around buildings, harbor pests such as wasps, and obstruct pest management survey and control activities
3. Deer-attracting plant material

## 3.5.3 Plant Removal and Replacement

The Bethesda enclave is a well-planted campus environment which hosts many treasured mature specimens as well as rare trees, shrubs, and groundcover species. All plant removals must be approved in advance by the ORF Landscape Architect. NIH is home to numerous Champion Trees, defined as trees that are the largest of their species in the county or state and are recognized by the applicable Department of Natural Resources. Under no circumstances are Champion Trees to be removed. In all cases where the ORF Landscape Architect does not approve removal of plants, the project should make proper arrangements for preservation and protection of plants during construction. Large trees are extremely valuable campus assets, especially regarding environmental functions such as: sequestering carbon, intercepting storm water runoff, transpiring groundwater, and supporting wildlife habitat (see [Figure 3.5.3](#)).

All plant material removed for utility work, clearing, grading, or other construction disturbance is required to be replaced. Shrub and groundcover areas shall be replaced in kind with new nursery-grown plants of the same species, quantity, and spacing. Otherwise, an alternative planting plan can be developed that is more responsive to the proposed site conditions, as approved on a case-by-case basis by the ORF Landscape Architect. Invasive plant species shall not be replaced in kind; instead, a suitable non-invasive plant species shall be substituted. It is not permitted to remove landscape plantings and replace with turf, gravel, or bare mulch. For removed trees, plan for replacement trees according to the NIH Tree Replacement Policy, as outlined in Section 3.5.4.

## 3.5.4 Campus Trees

The Forest Conservation Plan (FCP) and NIH Tree Replacement Policy shall govern all trees within the Limits of Disturbance (LOD) or otherwise impacted by the project. The NIH Tree Replacement Policy requires either 1:1, 1:4, or 1:8 tree replacement ratios, depending on the size and health status of the tree and the plan conditions (see [Exhibit 3.1 Tree Replacement Matrix](#)). Replacement tree size and species shall be per the notes in the Tree Replacement Matrix.

Any project involving exterior work shall identify and make note of any trees within the LOD and replace them regardless of the reason for tree elimination, including removal to accommodate the project or tree sickness. Trees being removed to accommodate the project shall be removed only if the project's final grading, associated utility work, or constructed area requires their removal. No trees shall be eliminated in order to exclusively accommodate temporary construction measures, such as construction entrances, lay-down areas, or other temporary construction operations and practices. This policy applies specifically to the NIH Bethesda and Poolesville campuses.

Currently, the NIH Urban Forest Conservation Plan (NIH UFCO, FCP#C06-04) does not exist in an electronic "linkable" format. The NIH UFCO incorporates the required elements of the Maryland Forest Conservation Act (MFCA); it includes the NIH Tree Replacement Policy and standard tree protection measures, and it has been prepared to comply with the MFCA in support of the NIH Master Plan.

Any project that requires a Sediment and Erosion Control permit from the Maryland Department of the Environment shall submit a project-specific FCP to maintain the NIH UFCO. These project-specific FCPs are considered updates to the NIH UFCO, but do not need to go through the extensive Maryland Department of Natural Resources (DNR) review. A project-specific FCP shall be prepared by a Maryland-licensed forester, licensed landscape architect, or other qualified professional. Any work performed on trees, including limb and root pruning or cutting, shall be performed by a Maryland-licensed tree expert. Upon completion of the project, the plans shall be properly certified by a qualified professional. All documentation for a project-specific FCP shall be submitted to the Division of Environmental Protection (DEP) and contain the following:

1. Project name and Project Officer identification
2. Name of Maryland qualified professional who prepared the plan and shall certify upon completion of the project that it has been completed in accordance with the plan
3. Area of permanent additional soil disturbance

4. Number of trees to be removed and location on plan - must include tag number, species, and size (DBH)
5. Number of trees to be relocated and location on plan - must include tag number, species, and size (DBH)
6. Tree replacement calculation according to requirements of [Exhibit 3.1 Tree Replacement Matrix](#)
7. Number of trees to be planted and location on plan (must include species and size)
8. A copy of one of the following project plans:
  - a. Sediment and Erosion Control plan
  - b. Landscape plan
  - c. Simplified FCP application

The A/E shall consult with ORF's landscape architect(s) and DEP for additional guidance/updates and for final review and regulatory follow-up. The NIH Landscape Architect handles the technical review related to planting plans, tree relocation, and selection of species, etc.; the environmental compliance staff handles the technical regulatory review. Both units work together to maintain and update the NIH UFCO. Additional guidance can be obtained through the Maryland Department of Natural Resources (DNR).

**Figure 3.5.3 Campus Asset, Large Tree**

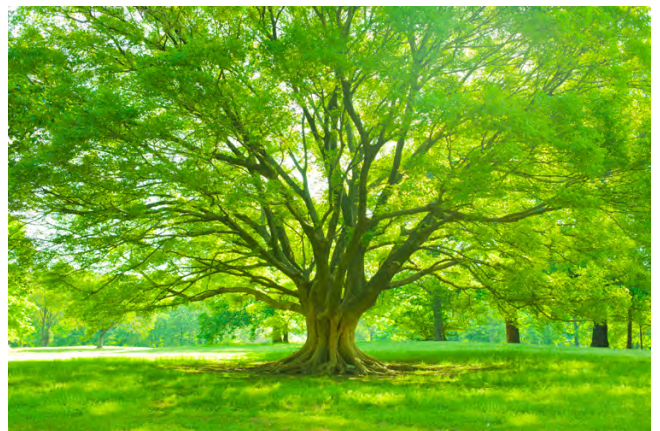

# Exhibit 3.1

## Tree Replacement Matrix

---

Existing Tree Removed		Existing Tree Removed Within New Building Footprint**		Existing Dead Tree Removed***	
Existing Tree DBH*	Replacement Trees	Existing Tree DBH*	Replacement Trees	Existing Tree DBH*	Replacement Trees
1 to 20	1	1 to 20	1	1 to 20	1
20-40	4	20-40	1	20-40	1
40+	8	40+	1	40+	1

\*diameter at breast height: measurement in inches of trunk diameter 4'-6" above ground level

\*\*defined as within new occupied building or MLP exterior envelope extents

\*\*\*health as determined by an ISA-certified arborist

Replacement Tree Notes:

1. Replacement deciduous trees shall be a minimum of 51 mm (2 in.) caliper.
2. Replacement evergreens shall be a minimum of 2.4 m (8 ft) height.
3. Replacement ornamental and understory trees shall be a minimum of 2.4 m (8 ft) height.
4. Native species are preferred over non-invasive exotics.
5. All new trees should be installed with deer protection for their trunks.
6. Plants shall be specified to be nursery grown and delivered in containers or balled and burlapped.
7. For replacement tree quantities over 20, no single tree species shall constitute more than 50% of the mix.
8. Ornamental or understory trees shall make up no more than 50% of the mix.
9. Tree planting should only take place between the months of September and May.



# Exhibit 3.2

## Sample Tree Replacement Calculation Charts

---

<b>Tree Demolition Table (Existing Trees)</b>						
No.	ID	DBH	Species	Notes	Replacements	
1	360	7"	Cherry		1	
2	487	6"	Linden		1	
3	488	32"	Pine	Dead	1	
4	1196	22"	Pine		4	
5	1197	30"	Poplar	In Footprint	1	
6	1592	19"	Sweetgum		1	
7	1874	2"	Dogwood		1	
8	1875	3"	Cherry		1	
9	1876	45"	Oak		8	
10	1877	14"	Poplar	In Footprint	1	
11	1878	28"	Pine		4	
12	1924	4"	Linden		1	
13	1926	17"	Honeylocust		1	
14	1927	4"	Crab Apple	In Footprint	1	
15	1928	7"	Pear	In Footprint	1	
16	1929	2"	Oak	Dead	1	
17	1938	33"	Maple		4	
<b>Trees needed</b>					<b>33</b>	

<b>Tree Planting Schedule</b>						
Qty	Key	Botanical Name	Common Name	Size	Stock	Spacing
<b>Shade Trees</b>						
4	NS	Nyssa sylvatica	Black Gum	75mm (3" cal)	B&B	per plan
7	QP	Quercus phellos "Hightower"	Willow Oak	75mm (3" cal)	B&B	per plan
1	TD	Taxodium distichum	Bald Cypress	100mm (4" cal)	B&B	per plan
<b>Evergreen Trees</b>						
3	CJ	Cryptomeria japonica	Japanese Cedar	2.4m (8' ht)	B&B	per plan
10	IO	Ilex opaca	American Holly	3m (10' ht)	B&B	per plan
5	PT	Pinus taeda	Loblolly Pine	3.6m (12'ht)	B&B	per plan
<b>Ornamental/Understory Trees</b>						
4	AA	Amelanchier arborea	Serviceberry	2.4m (8' ht)	B&B	per plan
1	LI	Lagerstroemia indica "Natchez"	Crapemyrtle	3m (10' ht)	B&B	per plan
<b>35</b>	<b>Total Planted</b>					

# Chapter 4

---

## Architectural Design

# Section 4.1

## Exterior Envelope

---

### Contents

#### 4.1.0 Introduction

#### 4.1.1 General Requirements

##### 4.1.1.1 Moisture Migration

##### 4.1.1.2 Air Infiltration

##### 4.1.1.3 Thermal Resistance

##### 4.1.1.4 Joint Sealants

#### 4.1.2 Exterior Walls

##### 4.1.2.1 Exterior Building Materials

##### 4.1.2.2 Exterior Elements

##### 4.1.2.3 Masonry

##### 4.1.2.4 Curtain Walls

##### 4.1.2.5 Wall Thickness

#### 4.1.3 Roofing

#### 4.1.4 Windows

##### 4.1.4.1 Glazing

##### 4.1.4.2 Glazing for Impact Safety

##### 4.1.4.3 Provisions for Window Cleaning

##### 4.1.4.4 Windows for Historic Buildings

#### 4.1.5 Window Coverings

#### 4.1.6 External Shading

#### 4.1.7 Mock-Up

## 4.1.0 Introduction

A building's exterior envelope provides separation from the outdoor environment, and allows for the control of indoor air quality, thermal comfort, energy-efficiency, and day lighting. The exterior envelope, includes all components of the exterior wall systems (above and below grade), roof systems, and basement slab/floor systems.

### 4.1.1 General Requirements

The design of building envelopes must address the specific conditions unique to each building, including:

**A. Site Conditions:** Including geographic location, local and regional climate and weather conditions, topography, subsoil, surrounding built features, and orientation.

**B. Building Use:** Include office/administrative, research, animal facilities, healthcare, data centers, etc.

**C. Energy Performance Goals:** The performance of new and substantially modified envelopes must meet the energy and sustainability goals and standards set by energy and construction codes, and by federal, HHS, NIH and specific project requirements. When renovating existing buildings, as many of the energy goals as practical shall be included to improve the performance of the existing envelope.

**D. Environmental Issues:** The envelope must be designed to maintain the indoor environment by controlling exterior climate elements, including temperature, humidity, air infiltration, precipitation, solar exposure and radiation, glazing and day lighting, storm water and ground water. In addition, the envelope must be designed to withstand prevalent and design wind loads, seismic activity as per seismic zone, and may be required to meet a prescribed level of blast protection and security.

**E. Other Factors:** Other factors influencing envelope design include aesthetics, maintenance, and life cycle cost.

#### 4.1.1.1 Moisture Migration

All elements of the envelope shall be designed to prevent moisture migration through the envelope and condensation of water vapor within the building and the envelope assembly. Assembly design shall be based on a dewpoint analysis and vapor drive calculation, which shall include all wall components, including vinyl wall covering and other impervious finishes which can trap moisture. The assembly design shall maintain the dewpoint outside of the envelope assembly.

*Rationale: Dewpoint within the exterior envelope assembly results in condensation, which can degrade materials and cause mold.*

#### 4.1.1.2 Air Infiltration

All elements of the envelope shall be designed to minimize air infiltration and to meet or exceed International Energy Conservation Code (IECC) and other applicable codes and standards. Doors shall be gasketed or weather-stripped. Exterior cladding joints shall be sealed unless the cladding assembly is that of a rain screen facade. Cracks and openings in the building envelope should be sealed, gasketed, or weather-stripped. All new construction and buildings that are substantially altered must include airlock-type vestibules or revolving doors at all primary entrances and exits to reduce air infiltration.

#### 4.1.1.3 Thermal Resistance

The thermal characteristics of single materials and composite design of exterior wall and roof assemblies shall be obtained or designed and calculated, and shall comply with the requirements as outlined in [Chapter 6: Mechanical Design](#), in compliance with applicable energy conservation code requirements. For each assembly the optimum thermal performance shall be calculated.

#### 4.1.1.4 Joint Sealants

**A. Compatibility:** Joint sealants shall be compatible with the respective materials of the envelope assembly.

**B. Application:** They shall be applied as required for thermal and moisture protection, and as required for fire stopping penetrations per UL requirements. For

joint sealant requirements in containment areas, see [Appendix L: Sealant Table](#).

**C. Pest Management:** The A/E shall specify sealants as required for pest management. See [Appendix L: Sealant Table](#), for sealant requirements.

When the application of sealants is indicated for any of the above reasons, the most stringent requirements shall apply.

## 4.1.2 Exterior Walls

**A. Compatibility:** The materials and aesthetic of exterior wall systems shall be compatible with the styles of existing facilities on campus, and consistent with the goals and requirements of the NIH master plan. All building designs shall be presented to and receive approval from the Architectural Design Review Board (ADRB). The design shall take into consideration the visual impact of the new structure, especially on surrounding buildings.

*Rationale: Compliance with the NIH master plan and approval of the ADRB ensures that the integrity of the campus aesthetic will be maintained.*

**B. Standards:** Design and construction of exterior walls shall be based on standards, specifications, and publications for the cladding and wall system products selected, i.e., masonry, curtain walls, glazing, metal panels, etc.

**C. Control:** Exterior walls shall be designed to control airflow, temperature conduction, and moisture migration into and out of the building. The R- and U-values of wall components and assemblies shall be assessed, calculated, and modeled to ensure that building codes, sustainability goals, and energy performance requirements are met. Air barriers shall be provided to control air infiltration.

**D. Vapor Retarder:** A vapor retarder must be included in the assembly, and must be provided commensurate with current ASHRAE and industry recommendations.

**E. Dewpoint Analysis:** Dewpoint analysis shall be performed to ensure that condensation will not occur within the envelope assembly and/or inside the building under any environmental condition.

**F. Water/Moisture Direction:** Air spaces, drainage planes, weep holes, flashing, and other devices shall be provided and properly detailed to direct water and moisture to the outside of the wall system.

**G. Air Barriers and Vapor Drive:** Calculate the vapor drive expected in the exterior wall assembly to determine the conditions and determine if an air barrier is required to block the migration of vapor.

### 4.1.2.1 Exterior Building Materials

Exterior cladding shall meet engineering standards with respect to sustainability including recycled content, embodied energy, local sourcing, assembly and delivery, life cycle expectations, reuse, and methods of construction. In selecting building materials, careful consideration must be given to all technical criteria and the requirement for high durability and minimal maintenance.

### 4.1.2.2 Exterior Elements

Mechanical, electrical, transportation, and other equipment items that are located along the exterior of the facility shall be integrated into the design wherever possible. This includes elements such as air intake/exhaust louvers, lighting fixtures, site utility connections, plumbing vents, fuel tank vents, liquid oxygen tanks, transformers, trash compactors, containers, and loading docks.

*Rationale: All exterior elements shall reinforce and be part of a uniform, cohesive building design.*

### 4.1.2.3 Masonry

**A. Standards:** Design and construction of masonry systems shall be based on standards, specifications, and publications for the products selected, including those by the American Society for Testing and Material (ASTM), American Concrete Institute (ACI), Building Stone Institute, Structural Clay Products Institute, Indiana Limestone Institute, Marble Institute



of America, National Building Granite Quarries Association, National Concrete Masonry Association, Brick Industry Association including their Technical Notes, and the Portland Cement Association.

**B. Masonry Facade:** If a building facade will be faced with brick or concrete masonry facing units, the backup across the cavity is preferred to be one of reinforced concrete masonry units (CMU). Waterproofing and/or air barrier is required on the outside surface of the backup wall.

**C. Structural Metal Studs:** If cost/benefit analysis indicates substantial savings by using structural metal studs, Brick Industry Association Technical Notes standards shall apply with the exception that structural metal studs shall be designed with a maximum flexure under design loads of  $L/720$ , or stiffer when required by code or governing authority.

**D. Anchorage:** Anchorage of the brick facing shall be designed so as not to be subject to corrosion at the fastener to metal stud location. Consideration shall be given to application of waterproof coating covering to all anchor locations.

#### 4.1.2.4 Curtain Walls

Design and construction of unitized or stick system curtain walls shall be based on standards, specifications, and publications for the products selected, including those by the ASTM, American National Standards Institute (ANSI), Aluminum Association (AA), Architectural Aluminum Manufacturing Association (AAMA), ACI, Metal Lath/Steel Framing Association, National Association of Architectural Metal Manufacturers, National Concrete Masonry Association, National Precast Concrete Association, Portland Cement Association, Precast Concrete Institute, Structural Clay Products Institute and Brick Industry Association.

#### 4.1.2.5 Wall Thickness

Placement of the wall in relation to the perimeter structure affects the construction cost, in as much as it affects the fenestration type, the shading effect or potential and the method of assembly and/or installation. Careful consideration shall be given during the design process to develop the optimum wall type and thickness that satisfies the above elements in the most effective manner.

### 4.1.3 Roofing

**A. Compatibility/Durability:** Roofing systems shall be compatible with structural framing systems, and provide a complete, readily repairable, waterproof assembly. The system should be durable, require minimal maintenance, and must provide the fire ratings and classifications required.

**B. Warranties:** Warranties shall be provided for various types of roofing systems based on specific NIH input during design. Warranties must provide long term protection and value appropriate to the product, and shall not be less than twenty years NDL (no dollar limit).

**C. Standards:** Roofing systems shall be designed in accordance with the recommendations of the National Roofing and Contractors Association Roofing and Waterproofing Manual, Factory Mutual Guidelines, ASTM Specifications and Tests and Methods, National Bureau of Standards, and Underwriters Laboratories (UL).

**D. Wind Resistance:** The roofing system shall be designed for resistance to wind-generated uplift forces as modeled and designed in accordance with recent available wind data for the respective area (available from the National Oceanic and Atmospheric Administration (NOAA)).

**E. Roof Penetrations:** The roof penetrations should be minimized to the greatest extent possible. Penetrations shall not be installed in valleys or near drains or scuppers.

**F. Roof-Mounted Equipment:** When roof-mounted equipment is used, the equipment should provide the lowest profiles for the application used. The supports shall be designed for the equipment size and weight, with sufficient clearance to allow for roof repair or replacement without disturbing the equipment, and for construction in a manner so as not to violate the integrity of the waterproofing system.

**G. Slope:** All roofs shall be designed with a minimum positive slope of 21 mm/m (1/4 in. per linear ft.) to roof drains or gutters with consideration of greater slope where possible.

**H. Overflow Protection:** All low-slope roofs shall incorporate emergency overflow protection via scuppers. Scuppers shall be located to minimize water accumulation if roof drains are blocked.

*Rationale: Scuppers are less likely to be blocked than overflow drains, and provide a highly visual indication that roof maintenance is required.*

**I. Future Vertical Expansion:** Consideration for future vertical expansion of the building should be incorporated in the roofing design on a project-by-project basis.

**J. Accessibility:** All areas of low-slope roofs shall be readily accessible for inspection and maintenance. All primary roof areas shall be accessible via an interior stair and full-sized door. All secondary roof areas (including elevator overruns and stair roofs) shall be accessible via ladder. All roof access points must be secured per DPSM requirements.

**K. Fall Protection:** All roofs shall be designed with fall protection systems approved by DOHS. Systems may include parapet walls, lifeline fall protection systems, installed anchor points for fall arrest system attachment or other systems that provide protection from fall hazards.

**L. Lightning Protection:** Lightning rod systems shall be designed to prevent impalement hazards for those who access roofs for maintenance.

**B. Appearance/Function:** Appearance, function, heat gain and loss, air filtration, safety, structural requirements, suitability for the environment, operation and maintenance experience shall be considered.

**C. Standards:** Windows shall be designed considering NFPA and ASHRAE codes and regulations, aesthetic appearance, and the comfort of all users of the facility. Window design and construction should be based on the standards, guidelines, and publications of the ASTM, ANSI, AA, Architectural Aluminum Manufacturing Association, National Institute of Testing and Standards, and the Steel Window Institute.

**D. Flashing/Sealants:** All exterior windows require sill pan flashing, subsill membrane flashing, jamb membrane flashing, and membrane head flashing. Metal head flashing may be considered. All details, including membrane air seals shall be assessed to ensure minimal risk for condensation. All windows shall be fully taped and sealed into the opening and must be fully weeped. Provide end dams at all opening flashing in masonry walls.

**E. Sill Slope:** Exterior sills in single punched or ribbon window designs shall be sloped to ensure positive drainage. All interior window sills shall be sloped, and all windows shall be sealed to ensure ease of cleaning and decontamination.

**F. Blast Protection:** Window assemblies may have to be designed for requirements as prescribed by the threat risk assessment and DPSM.

## 4.1.4 Windows

**A. Operable Windows:** Operable windows are not permitted in NIH research laboratories and ARFs. The use of operable windows may be considered in new administrative office buildings not containing research labs.

*Rationale: Operable windows cause uncontrolled fluctuations of the air in a room, which can be detrimental to the operation of BSCs, fume hoods and other equipment. Fluctuations are also detrimental to maintaining pressurization and directional air flow and controlling air temperature and humidity.*

### 4.1.4.1 Glazing

**A. Double Glaze:** All glazing, including exterior doors, glazed panels, and skylights, shall be double glazed with a continuous thermal break.

**B. Standards:** All glazed units shall have energy performance rating factors as evaluated in accordance with the National Fenestration Rating Council (NFRC) procedures to minimize air infiltration.

**C. Type/Amount:** The amount and type of glazing shall be carefully studied in relation to the specific energy conservation goals and requirements of the project, building function, and building/facade orientation.

**D. Condensation:** Condensation should not be apparent on glass when at the building's design temperature and humidity range.

**E. Glazing Units:** All glazed openings in a building envelope shall have energy-efficient low-emissive (Low-e) coated insulated glazing units (IGUs).

Glazing units shall feature high visible light transmission while providing a low solar heat gain coefficient (SHGC). SHGC shall not exceed 0.27 on east, south, or west facing facades, and 0.6 on north-facing facades.

**F. Glazing Mullions:** Glazing mullions shall be fully thermally broken aluminum frames with fully integrated, omnidirectional internal guttering.

**G. Curtain Wall Systems:** Curtain wall systems shall be either four-sided structural silicone glazed or mechanically secured with pressure bar systems, or a combination thereof.

**H. Other Considerations:** All glazing designs should be evaluated for aesthetics, building function, energy conservation goals, solar shading characteristics, visible light transmittance, and solar reflectance. Care must be taken to evaluate each building elevation individually. Glass sizes and thickness shall be based on modeled wind loads and thermal characteristics of the climate zone where the building is located. Blast resistant or security glazing systems may be required.

#### 4.1.4.2 Glazing for Impact Safety

Because of the size and shape of glazing in some locations, glass panels may be mistaken for a means of entry or exit and therefore may be subject to human impact. The requirements of ANSI Standard Z97.1, NFPA 80 and NFPA 101 shall be followed. Sill heights less than 762 mm (2 ft. 6 in.) above the finished floor must have an intermediate horizontal mullion, or suitable alternative, included in the fenestration or design at that height. If laminated glass is required for double-glazed windows with a sill/stool less than 2 m (6 ft. 6 in.) above finish floor and for windows facing a courtyard, a laminated glass interior pane and tempered glass exterior pane shall be provided. If laminated glass is required for double-glazed windows, it shall be provided for interior panes only.

#### 4.1.4.3 Provisions for Window Cleaning

The need for window cleaning, facade access, and maintenance from both the interior and the exterior including replacement of glazing shall be considered during design. Provisions for window cleaning and facade access equipment must be included in the design for all facilities. For surfaces three stories and less above accessible location(s), the provision of built-in access is not required unless constraints make placement of ladders and lifts impractical.

*Rationale: Window washing and facade inspection and access is an important part of building maintenance and must be safe and accessible.*

Figure 4.1.6 Sunshading at Building Entrance



#### 4.1.4.4 Windows for Historic Buildings

Projects affecting the windows of a historic building shall comply with the Secretary of the Interior's Standards for Rehabilitation and Guidelines for Rehabilitation Historic Buildings and the State Historic Preservation Office (SHPO). The A/E shall coordinate the design requirements with the NIH Historic Preservation Coordinator.

### 4.1.5 Window Coverings

Window coverings can limit access of warm air in winter months from reaching the windows. Consistent visual appearance on the exterior of the building shall be maintained by the type of external shading components integral to the facade or internal window treatment selected. Window treatments shall sufficiently reduce glare while permitting as much light as possible. Light-tight treatments shall be provided in all spaces that require room darkening based on program needs, such as conference rooms, laboratories, animal holding rooms, etc.

### 4.1.6 External Shading

External shading components integral to the facade or internal to window glazing should be considered to shade interior spaces and to reduce thermal loads on facades. See [Figure 4.1.6](#). External components shall be located and configured to minimize hazard from ice or snow, and shall be designed with regard to applicable design loads, wind, seismic, blast, etc.

### 4.1.7 Mock-Up

**A. Testing:** Prior to construction of the building envelope, the facade design shall undergo testing for air and water infiltration under normal conditions. The size of the mock-up may vary and depending on the type and application, the mock-up can be a field mock-up or an off-site mock-up. However, for a new building of substantial size, a mock-up should include one bay in width by one full story in height so that all typical structural anchor positions (lateral [wind] and gravity) may be included in the test series. When cumulative bay-to-bay or interfloor rotation must be considered, a two bay and/or two floor mock-up should be considered.

*Rationale: Mock-ups are essential for testing aspects of a systems performance, and for assessing workmanship, detailing, compatibility, and aesthetics prior to installation.*

**B. Testing Protocols:** Testing protocols may vary depending on the design and facade type. Testing should be done in conformance with AAMA, ASTM, ANSI, CSA and CPSC protocols and may be customized in accordance with the design team's and NIH's requirements.

**C. Seismic Considerations:** In regions where seismic design is an important consideration, the mock-up should feature a racking rig so that seismic movement can be simulated both during water testing and dry testing (racking only).

**D. Environmental Considerations:** The mock-up shall feature a fully sealed rear-mounted pressure chamber that will withstand cycling of pressure between maximum negative and maximum positive design pressures under wind-driven rain conditions.

# Section 4.2

## Doors

---

### Contents

#### 4.2.0 Introduction

#### 4.2.1 General Requirements

##### 4.2.1.1 Minimum Size

##### 4.2.1.2 Life Safety Requirements

##### 4.2.1.3 Physical and Electronic Security Requirements

##### 4.2.1.4 Exterior Doors and Frames

##### 4.2.1.5 Interior Doors and Frames

##### 4.2.1.6 Hardware

##### 4.2.1.7 Glazing

#### 4.2.2 Laboratory Doors

##### 4.2.2.1 Sealant

##### 4.2.2.2 Size of Laboratory Doors

##### 4.2.2.3 Laboratory Door Life Safety

##### 4.2.2.4 Physical and Electronic Security

##### 4.2.2.5 Laboratory Exterior Doors

##### 4.2.2.6 Laboratory Interior Doors

##### 4.2.2.7 Laboratory Door Hardware

##### 4.2.2.8 Laboratory Door Glazing

#### 4.2.3 Animal Research Facility Doors

##### 4.2.3.1 General Requirements

##### 4.2.3.2 Size of ARF Doors

##### 4.2.3.3 ARF Door Life Safety

##### 4.2.3.4 Physical and Electronic Security

##### 4.2.3.5 Exterior ARF Doors

##### 4.2.3.6 Interior ARF Doors

##### 4.2.3.7 ARF Door Hardware

##### 4.2.3.8 Animal Research Facility Door Glazing

#### 4.2.4 Specialty Doors, Frames, and Hardware



## 4.2.0 Introduction

Doors play an important role in achieving various functional and programmatic requirements such as differential air pressurization, light control, contamination control, pest management, life safety, and equipment movement. Doors and frames are particularly vulnerable to deterioration and damage from heavy use. High-quality doors, frames, and hardware shall be selected based on intended purpose in consultation with the Project Officer (PO), facility manager, and space user. The specific requirements for doors, frames, and hardware contained herein are developed from the NIH's experience maintaining these items.

### 4.2.1 General Requirements

During the programming and conceptual phase, address the following requirements or concerns for each class or type of door:

1. Unusual height or width
2. Unusual durability requirements
3. Light control requirements (nominal light control, light-tight requirement, light-frequency control, light containment (laser use), etc.)
4. Contamination (direction of swing, hands-free operation, etc.)
5. Exposure of door, frame, and hardware to decontamination chemicals and/or harsh environmental conditions
6. Differential pressure containment/operation/annunciation
7. Electronic access control and annunciation
8. Visual access (lights)
9. Hardware type, quality or placement

Pocket doors, bifold doors, and accordion doors are not permitted in NIH biomedical laboratories or animal research facilities (ARFs).

Manual surface mounted sliding doors may be allowed if approved by the PO, DFM, DOHS and under the following conditions:

1. Serving rooms which are low hazard and low occupancy (one or two persons)
2. Serving a room with a non-laboratory function (typically an office or administration area)
3. Not required for fire rating or pressurization

***Rationale:** Pocket doors are not allowed because the pocket door hardware is difficult to maintain, and wall pockets are inaccessible and difficult to clean. Surface mounted sliding doors are limited to non-laboratory functions because they are not self-closing (as required by BMBL), can impede egress and speedy access to an emergency shower, and do not seal tightly.*

#### 4.2.1.1 Minimum Size

Minimum Door Width: 914 mm (3 ft.)

Minimum Door Height: 2.1 m (7 ft.)

#### 4.2.1.2 Life Safety Requirements

Where doors are required to be fire rated, appropriately rated UL label doors and frames shall be specified. Power-assisted fire-rated doors shall be provided with an interconnection with the fire alarm system to deactivate the power to the door operator when the fire alarm activates. Inactive leaves in a pair of fire-rated doors at the entrances to laboratory work areas or laboratory equipment rooms shall have constant latching flush bolts and are not required to be self-closing.

#### 4.2.1.3 Physical and Electronic Security Requirements

**Electronically Locked Doors:** Coordinate with the AHJ and DPSM to determine if electronically locked doors shall fail-safe or fail-secure. In general, all doors serving high value or hazardous areas, including animal research and biocontainment facilities, shall fail-secure while meeting egress requirements. Specialty labs shall be assessed individually to meet the requirements of safety, security and containment.



#### 4.2.1.4 Exterior Doors and Frames

**A. Entry Doors:** Building entry doors shall comply with DPSM requirements and approved by DPSM. Blast hardened doors may be required for blast resistant facilities.

**B. Visibility:** Locate exterior doors for maximum visibility.

**C. Pest Management:** Exterior doors shall be equipped with a nylon bristle door bottom, installed to seat against door stops. Double-door sweeps shall be right-angle type with the vertical leg extending a minimum of 152 mm (6 in.) above finished floor (same requirement for interior doors requiring sweeps).

##### D. Aluminum Storefront Doors and Frames:

1. **Glazing:** Building entry and entry vestibule doors shall be fully glazed.
2. **Construction:** Thermally broken frame construction, closed door tops, seamless construction

##### E. Steel Doors and Frames:

1. **Finish:** Galvanized, shop primed and field painted
2. **Construction:** Heavy duty, ANSI A250.8 level 3 (16 gauge), physical performance level A, model 2, seamless Frames: Fully welded, ANSI A250.8, level 3 (14 gauge)

#### 4.2.1.5 Interior Doors and Frames

**General:** Interior doors and frames shall meet General Services Administration (GSA) Facilities Standards (P100).

See sections 4.2.2 and 4.2.3 for additional requirements applicable to laboratory and ARF doors.

**A. Administrative Office Doors within Laboratory Suites:** May be considered non-laboratory door and frame.

**B. Undercut:** Interior doors shall be undercut a minimum 13 mm (1/2 in.) and maximum 19 mm (3/4 in.).

##### C. Interior Steel Doors and Frames:

1. **Finish:** Shop primed, field painted

##### D. Interior Aluminum Storefront Doors and Frames:

1. **Finish:** Anodized finish for all aluminum components
2. **Construction:** Non-thermally broken frame construction, closed door tops, seamless construction

#### 4.2.1.6 Hardware

**A. Use:** All doors shall be considered high use and hardware specified accordingly. Light commercial or residential-grade hardware is not acceptable.

**B. Hardware and Keying:** Door hardware and keying shall comply with Division of Police (DP), ORF Locksmith Unit, and DPSM. Coordinate with DPSM for specific security requirements and door hardware.

**C. Card, Biometrics, or Other Electronic Access Readers:** Provide physical access control for doors as required by the program or by the DPSM. Access readers shall be located adjacent to doors.

**D. Electronic Hold-Open Devices:** Provide electronic hold-open devices on doors in high traffic areas and where corridor doors are required for fire separation, but not for security or environmental segregation. Coordination is required with the means of egress plan and the DFM.

**E. Door Plates:** Provide stainless steel armor, kick, mop, and stretcher plates on doors based on door location and room use. See [Figure 4.2.1.6](#) for plate configurations. Center plates horizontally on the door at a width 51 mm (2 in.) less than the door width. Door plates shall maintain UL rating, and must be specified in the door schedule.

##### F. Exterior Door Hardware:

1. **Closers:** Provide closers for all exterior doors.
2. **Tamper Resistance:** Hinges, hinge pins, and hasps shall be secured against unauthorized removal by spot welds or use of peened mounting bolts.

Figure 4.2.1.6 Door Plate Types

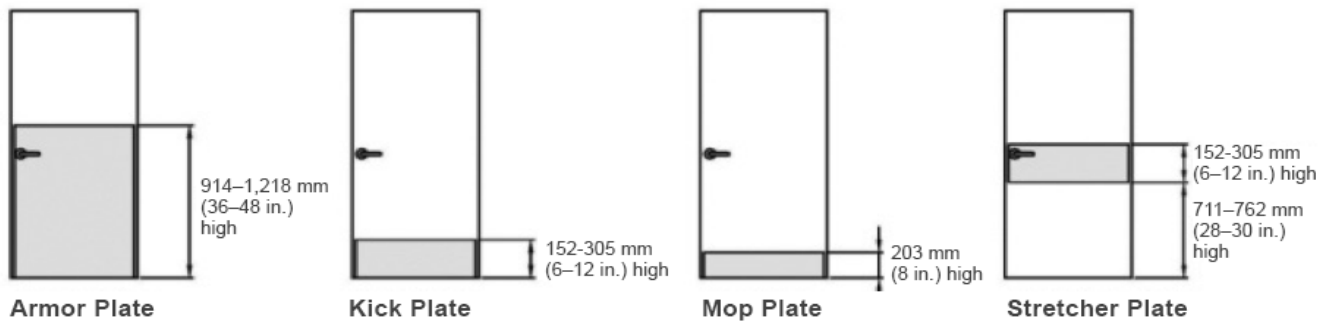

- Astragal:** Provide astragal or lock guard to prevent jimmying of the latch.

**G. Egress Only Doors:** Doors used exclusively for emergency egress shall not have operable hardware on the exterior of the door for security purposes.

#### 4.2.1.7 Glazing

**A. Exterior Door Glazing:** Insulated tempered glass, clear, low emissivity coating, unless building standard requires specific tint or coating

**B. Interior Door Non-rated Glazing:** Clear tempered

## 4.2.2 Laboratory Doors

Laboratory doors shall be of adequate size to install and remove all equipment, including oversized equipment. In addition to general requirements, the following requirements shall apply to laboratory doors.

#### 4.2.2.1 Sealant

**Sealant:** Seal every joint between frames and adjacent construction. Refer to [Appendix L: Sealant Table](#).

#### 4.2.2.2 Size of Laboratory Doors

**A. Minimum Size:** Each laboratory room shall be served by at least one 1.1 m (3 ft. 6 in.) wide single leaf, or 1.2 m (4 ft.) wide unequal pair doors (914 mm [3 ft.] active/305 mm [1 ft.] inactive) for delivery of equipment and supplies. Laboratories with unusually large

equipment shall have doors of adequate size to move such equipment.

**Exceptions:** 914 mm (3 ft.) Doors: A laboratory with multiple entries, including at least one 1.1 m (3 ft. 6 in.) or 1.2 m (4 ft.) wide entry, may have 914 mm (3 ft.) wide secondary doors provided those doors are not situated in a logical path for delivery of laboratory supplies.

**B. Administrative Offices:** Doors serving administrative offices within laboratory suites may be 914 mm (3 ft.) wide.

#### 4.2.2.3 Laboratory Door Life Safety

**A. Direction of Swing:** Laboratory doors shall open in the direction of exit travel. For most laboratories, doors should swing in the direction of egress to facilitate exiting and access to an emergency shower. Doors swinging into a corridor shall be fully or partially recessed so that the required corridor width is not reduced, and to eliminate potential conflicts with corridor users.

**Exceptions:** Doors within laboratories serving areas not using chemicals (i.e., administrative, offices, microscope rooms) are permitted to swing opposite the direction of egress.

Doors serving biocontainment laboratories ordinarily swing in the direction of air movement (clean to dirty). Review and obtain approval of the DFM and DOHS for these doors.

**B. Illuminated Warning Signage:** Coordinate requirements for illuminated warning signage with the PO. Such signage may be required for hazardous or sensitive

functions like confocal microscopy, laser rooms, animal behavioral labs, magnetic resonance imaging (MRI), nuclear magnetic resonance (NMR), X-ray, and other radioisotope imaging and procedures.

#### 4.2.2.4 Physical and Electronic Security

**A. Function:** Provide classroom function locks on all laboratory suite entrance doors, except where laboratory function requires alternative lock function as directed by the PO.

**B. Electronic Locks and Card Readers:** Provide electronic locks and card readers where directed by the PO and the DPSM. Confirm ‘fail-safe’ and ‘fail-secure’ functions based on security and programmatic requirements.

#### 4.2.2.5 Laboratory Exterior Doors

Exterior doors entering directly into a laboratory are prohibited unless required for egress. If required for egress, the door shall be alarmed. Coordinate with DPSM for security requirements.

#### 4.2.2.6 Laboratory Interior Doors

Laboratory doors and frames are subject to impact, wear, and heavy use. Doors shall be heavy duty, ANSI A250.8 Level 2 (18 gauge), physical performance level A, model 2, seamless.

**A. Frames:** Fully welded, 16 gauge

**B. Hollow Core:** Interior laboratory doors may be hollow construction, except doors serving ARFs must be solid core without voids.

#### 4.2.2.7 Laboratory Door Hardware

**A. Closers:** Provide closers on all laboratory doors. Closer shall permit doors to open ninety degrees minimum. Hold open devices shall not be installed on laboratory doors.

*Exceptions: A door serving an administrative office within a laboratory suite is not required to have a closer if not required by code.*

**B. Bumper Rails:** Install bumper rails and door handle protectors on doors in high-use traffic areas.

**C. Sill and Jamb Seals:** Provide sill and jamb seals where required by program.

**D. Coordination:** Coordinate location of door seals with pressurization, containment and other requirements.

**E. Sill Berm and Seal:** Provide slight berm and tightly fitting door sill sweep at aquatic rooms, chemical storage rooms, and at any other rooms where there is the potential for flooding or where containment of spilled chemicals is required.

**F. Flush Bolts:** Provide constant latching flush bolts on inactive leaf of 1.2 m (4 ft.) active/passive laboratory doors.

**G. Manual Door Release:** Provide manual door release on the inside of all controlled environmental rooms.

**H. Select Agent Laboratory Door Hardware:** Provide door hardware consistent with Select Agent Standards including requirement for fifteen minute forced-entry resistance. Provide tamper-resistant high-security cylinders on the facility master lock for all doors serving laboratories containing select agents. Coordinate with DPSM for security requirements.

#### 4.2.2.8 Laboratory Door Glazing

**A. Vision Panels:** Provide vision panels on all laboratory doors. Provide hinged, light-tight covers on the inside of doors for laboratories that require light control or dark conditions.

*Rationale: Vision panels allow visual observation of the lab from the corridor and provide an element of safety and security.*

**B. Active/Inactive Doors:** Locate vision panel on active door leaf.

**C. Environmental Room Doors:** Provide vision panels on all environmental room doors.

**D. Select Agent Laboratory Doors:** Vision panes shall be sealed and rated for fifteen minute forced-entry break resistance.

## 4.2.3 Animal Research Facility Doors

### 4.2.3.1 General Requirements

In addition to general laboratory requirements, the following requirements shall apply to ARF doors.

**A. Construction:** Doors and frames shall be constructed with seamless construction and no recesses at top and bottom edges. Doors shall be solid or completely foam-filled, with no voids for insect harborage. Door assemblies shall be fully sealed, including hardware cutouts and mortises. Glazing and glazing frames shall be fully sealed as well.

**B. Vermin Resistance:** Provide seals, sweeps, screens, and other devices as required to provide vermin-resistant doors and frames at animal holding rooms, feed storage and preparation areas, and exterior doors.

**C. Insect Screens:** Insect screens, where used, shall be heavy duty stainless steel and detailed to be protected from physical damage.

**D. Corrosion Resistance:** Provide products that are maximally corrosion and chemical resistant.

**E. Epoxy Coated Steel:** Where epoxy coated steel is approved for use by the PO and program personnel, coating shall be shop applied (in factory or local fabrication shop) to all surfaces with field applied final coat on all exposed surfaces.

**F. Sealant:** Seal every joint between frames and adjacent construction. Seal each seam between fixed hardware and door to which it is applied. See [Appendix L: Sealant Table](#).

### 4.2.3.2 Size of ARF Doors

**Size of ARF Doors:** ARF doors shall be of sufficient width and height enable the frequent movement of large items, including caging racks. Minimum Size: 1.1 m wide x 2.3 m high (3 ft. 6 in. wide x 7 ft. 6 in. high).

**Exceptions:** Coordinate with program personnel where large animal caging requirements or other conditions dictate larger door sizes.

### 4.2.3.3 ARF Door Life Safety

Review direction of swing for each type of animal facility function with program personnel. Obtain approval of the AHJ.

### 4.2.3.4 Physical and Electronic Security

Provide electronic locks and card readers at all entrances to the animal facility and at all entrances to the loading dock serving the animal facility. Consult with the veterinarian and DPSM to determine if electronic locks and card readers are required on animal holding rooms or other functional spaces.

### 4.2.3.5 Exterior ARF Doors

Exterior doors entering directly into an ARF (within the facility barrier) are prohibited unless required for egress. If required for egress, door shall be alarmed.

### 4.2.3.6 Interior ARF Doors

Fiberglass reinforced polymer (FRP) doors are preferred, but steel doors can be used if approved by the PO and program personnel, are heavy duty, have a high-quality epoxy finish, are protected with armor plate, and are continuously welded without concealed voids or pockets that can harbor pests.

*Rationale: ARF doors subject to the movement of racks and equipment must have protective hardware and be of durable construction to withstand impact.*

**A. Automatic Doors:** Cage wash entry and exit doors shall be automatically operated.

**B. Type:** If space permits, use sliding type automatic rather than swing-type automatic doors (if sliding door is used, specify cleanable track with no voids that can harbor pests).

**C. Operator:** Operate doors with either paddle-type activator, or proximity or motion detection activation as appropriate. (Note some motion detectors emit sound that affects animals. Confirm specification with program personnel).

### 4.2.3.7 ARF Door Hardware

**A. General:** Specify industrial duty hardware that is suitable for wet environments and which is disinfecting-chemical resistant. Hardware shall not have voids or pockets that can harbor pests.

**B. Door Protection:** Provide effective door protection on all ARF doors. Install armor plate on all ARF doors along primary traffic paths or doors through which caging is being moved.

**C. Jamb Guards:** Provide stainless steel jamb guards on ARF door frames exposed to animal caging traffic.

**D. Door Sill Sweeps:** Provide nylon bristle door sill sweeps at animal holding rooms, feed storage and preparation areas, and other areas requiring vermin resistance. Install sweeps to seat against door stops. Double-door sweeps shall be right-angle type with a vertical leg extending a minimum of 152 mm (6 in.) above finished floor.

**E. Pulls and Latches:** Door pulls and latches shall be designed with profiles that will not hold water and without sharp edges that may tear gloves. Review options and selections with the program personnel.

**F. Hinges:** Continuous, 14-gauge stainless steel with 6.35 mm (1/4 in.) stainless steel pin.

**G. Magnetic Locks:** Where provided, magnetic locks shall not project into clear height of door openings.

**Figure 4.2.3.8 ARF Door Vision Panels and Hardware**



### 4.2.3.8 Animal Research Facility Door Glazing

**A. Vision Panels:** Provide vision panels on all animal holding room doors. See [Figure 4.2.3.8](#).

*Exceptions: Special purpose animal holding rooms or other functional spaces where program personnel advise against vision panel.*

*Rationale: Vision panels allow for the visual inspection of a room prior to opening the door.*

**B. Service Rooms:** Storage, janitor closet, and other service rooms do not require glazing.

**C. Window Covers:** Provide window covers over animal holding room glazing. Covers for red glazing may be omitted with approval of the program personnel.

**D. Red Glazing:** Red glazing at animal holding room view windows shall be laminated between clear glazing and provide limited light infiltration as required by program personnel.

### 4.2.4 Specialty Doors, Frames, and Hardware

**A. Automatic Doors:** Consider automatic doors where serving a large occupant load, where hands-free operation is necessary, or for frequent movement of large equipment (such as animal cages).

**B. Safety Devices:** Include safety devices on automatic doors.

**C. Power-Assisted Doors:** Power-assisted doors may be used instead of fully automatic doors, where appropriate.

**D. Revolving Doors:** Revolving doors are permitted and encouraged as main entry doors into a secure lobby. An emergency egress feature is required for revolving doors wherever used.

**E. Revolving Doors within Laboratory Suites:** Revolving doors are permitted within laboratory suites only if required by the program for a functional purpose.



**F. Screen Doors:** Interior screen doors within laboratories are acceptable if required by the program, typically for insectaries.

**G. Lead-Lined Shielded Doors:** Rooms containing radiation-emitting equipment may require radiation-shielding doors. Design and location of radiation-shielding doors must be approved by the NIH Division of Radiation Safety (DRS). Illuminated warning signage is usually associated with these doors and should be coordinated with the PO.

**H. Electromagnetically Shielded Doors:** Rooms containing magnetic resonance equipment (MRI, NMR) may require electromagnetically shielded doors. Doors serving these rooms shall swing out of the room to ensure operability in the case of room overpressure from a ruptured liquid nitrogen or helium coolant line. Illuminated warning signage is usually associated with these doors and should be coordinated with the PO. Radiofrequency/electromagnetic interference shielded doors that utilize an inflatable seal mechanism shall have a backup compressed air supply.

**I. Overhead Doors:** Overhead doors should only be used at loading areas and areas where openings larger than those provided by hinged doors are required. Overhead doors do not seal as tightly and are not as well insulated as hinged doors.

1. **Type:** Electrically operated for doors greater than 3.7 m x 3.7 m (12 ft. x 12 ft.). Doors 3.7 m x 3.7 m (12 ft. x 12 ft.) or less in size may be manually or electrically operated, depending of program need and frequency of use.

2. **Duty:** Industrial heavy duty grade
3. **Material:** Galvanized steel, shop primed, field painted. Consider use of aluminum door where duty grade is equivalent to eliminate requirement for painting.
4. **Exterior Doors:** Insulated, with weather stripping rubber gasket at sill and nylon bristle sweeps at the head and jambs to completely cover exterior gaps.
5. **Air Curtains:** Include air curtains or other devices to limit air and pest infiltration through overhead door. Air curtains shall be surface mounted directly above the interior face of the door head, and extend a minimum of 25 mm (1 in.) beyond each jamb.
6. **Other Devices:** Plastic strip doors or electric insect light traps should be also be considered.
7. **Pedestrian Swing Door:** Provide a pedestrian door at all overhead door locations.

*Rationale: Pedestrian doors are more convenient and allow the overhead doors to be used less frequently.*



# Section 4.3

## Partitions

---

### Contents

#### 4.3.0 Introduction

#### 4.3.1 General Requirements

##### 4.3.1.1 Gypsum Wallboard Construction

##### 4.3.1.2 Life Safety Requirements

##### 4.3.1.3 Structural Requirements

##### 4.3.1.4 Physical Security

##### 4.3.1.5 Acoustics

#### 4.3.2 Laboratory Partitions

##### 4.3.2.1 Laboratory Gypsum Wallboard Partitions

##### 4.3.2.2 Acoustics

#### 4.3.3 ARF Partitions

##### 4.3.3.1 General Requirements

##### 4.3.3.2 ARF Gypsum Wallboard Partitions

##### 4.3.3.3 ARF Concrete Masonry Unit Partitions

##### 4.3.3.4 Concrete Substrate Surfaces

##### 4.3.3.5 Wall Protection

##### 4.3.3.6 Corner Guards

##### 4.3.3.7 Sanitary and Pest Mitigation Features

##### 4.3.3.8 Sealants

##### 4.3.3.9 Acoustics

## 4.3.0 Introduction

This section includes special requirements for interior partitions. Except where more stringent requirements are required, comply with requirements contained in General Services Administration (GSA) Facilities Standards (P100).

## 4.3.1 General Requirements

### 4.3.1.1 Gypsum Wallboard Construction

**A. Construction:** Minimum construction shall consist of 16 mm (5/8 in.) thick gypsum wallboard applied to each side of 22-gauge, 92 mm (3-5/8 in.) metal studs spaced at 406 mm (16 in.) on center (minimum size and spacing). Wall construction shall be assessed and specifically designed, detailed and specified for pressurization, unusual height or loading, high abuse, security, moisture, fire rating or other special or unusual conditions. Moisture resistant gypsum board and other products may require additional support, particularly on ceilings.

**B. Mold Resistance:** Provide mold-resistant paper-faced gypsum board except in high moisture areas, or where potential for high abuse requires a moisture-resistant, impact-resistant, or other specialty product.

**C. Flood Resistant Detailing:** Design partitions with 89 mm (3-1/2 in.) high, non-gypsum-based, cementitious board complying with ASTM C1288 or coated glass mat water-resistant gypsum backing panel as defined in ASTM C1178 behind wall base in all areas prone to flooding or water damage, and for all walls with integral epoxy coved bases. Consideration for grouted bases to provide additional stability and water mitigation in ARF and biocontainment facilities shall be reviewed with the PO.

**D. Furring:** Minimum furring strip depth shall be 38 mm (1-1/2 in.) to allow for concealed electrical devices. Furring strips shall have structural capacity equal to partitions in any area that might reasonably support wall-mounted shelving.

*Exceptions: Furring on concrete columns may be 22 mm (7/8 in.) provided at least one side is 38 mm (1-1/2 in.).*

**E. Bracing:** Design lateral bracing in accordance with ASTM C754, Standard Specification for Installation of Steel Framing Members to Receive Screw-Attached Gypsum Panel Products (2009a).

**F. Finish:** As a minimum requirement, finish exposed gypsum wallboard partitions to level 4 per ASTM C 840. Finish areas to receive high-performance coatings shall be finished to a level 4 finish.

**G. Blocking:** Provide 18-gauge steel blocking wherever partition mounted items are indicated or can be reasonably anticipated in the future.

*Exceptions: Electrical, telecommunication, and data system component panels shall be mounted on 19 mm (3/4 in.) thick, fire-retardant treated, painted plywood.*

**H. Wall Protection:** Provide wall protection rails and corner guards in high-traffic areas and as required by design.

### 4.3.1.2 Life Safety Requirements

**A. UL Ratings:** Specify appropriate UL assembly reference numbers for fire-rated partitions in partition schedule.

**B. Material:** Partitions shall be constructed with non-combustible materials.

### 4.3.1.3 Structural Requirements

**Lateral Strength:** At a minimum, all partitions shall be designed to support lateral loads imposed by wall-mounted shelving, assuming continuous, 4-tier 305 mm (1 ft.) shelving carrying 23 kg (50 lb.) per linear foot of shelf (inclusive of dead load of shelf), whether shelving is installed or not. In conditions where deeper shelves, additional shelves, wall-mounted equipment, cantilevered casework or other loading exceed the minimum requirements above, the partition shall be designed for the actual imposed load.

For the purpose of design, shelving exceeding 305 mm (1 ft.) depth shall have a loading proportional to 23 kg (50 lb.) per linear foot for a 305 mm (1 ft.) shelf.

Provide structural certification and support and anchorage details for partitions with aggregate partition loading exceeding 45 kg (100 lb.) per linear foot and indicate location of such items on floor plans.

**Rationale:** Shelving and other wall-mounted items may be added to walls during the life of the facility so all walls must be constructed with a minimum load capacity.

#### 4.3.1.4 Physical Security

Coordinate physical security requirements for partitions with the DPSM and comply with requirements contained in the DPSM Guidelines. Extend partitions enclosing high-risk, hazardous, high-value, Sensitive Compartmented Information Facility (SCIF) or otherwise secure areas to underside of structure and reinforce as required by risk assessment.

#### 4.3.1.5 Acoustics

Demising partitions separating occupied areas from public corridors and from other functionally separate areas shall be constructed full-height from structural floor slab to structural floor slab or roof and achieve a minimum sound transmission class (STC) of 50 per ASTM E90.

Construction separating enclosed rooms and non-public corridors within a functional area shall achieve a minimum noise isolation class (NIC) of 45 per ASTM E 336. Plenum barriers shall be constructed above partitions if they terminate at the height of acoustic tile ceilings.

### 4.3.2 Laboratory Partitions

The following requirements for laboratory partitions are in addition to the minimum requirements indicated in Section 4.3.1.

#### 4.3.2.1 Laboratory Gypsum Wallboard Partitions

**A. Construction:** Studs in all laboratory areas, even if not for laboratory functions, shall be minimum 18 gauge. Stud size, bracing, spacing and other details shall be designed for the specific condition, including wall height, loading, pressurization, etc.

**Figure 4.3.2.1 Wall Strapping**

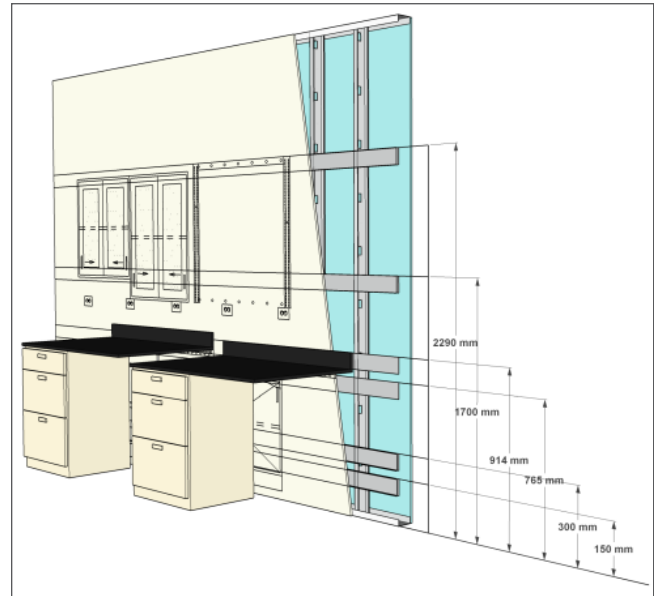

**B. Strapping:** The interior lab side of every partition shall have 102 mm wide (4 in.), 1.59 mm (1/16 in.) minimum metal gauge sheet metal straps, placed horizontally on the studs for the full length of the partition. Anchor the straps to each stud with two #12 screws. Install the top edge of these metal strips at the following heights: 152 mm, 305 mm, 762 mm, 914 mm, 1,676 mm, 2,286 mm (6 in., 12 in., 30 in., 36 in., 66 in., 90 in.). The heights of the two uppermost strapping tiers shall be coordinated with anchorage requirements of the specified casework and shelving system(s). To ensure flexibility for future use strapping should be installed at any partition where casework may be hung. Additional strapping shall be installed for wall-mounted equipment as necessary. See Figure 4.3.2.1.

**Rationale:** Strapping provides structural anchorage for wall-mounted items including equipment, casework and shelving.

#### 4.3.2.2 Acoustics

**A. General:** Coordinate with the laboratory representative to determine specific acoustic requirements for each type of specialty laboratory space. If special criteria is not required, comply with acoustic requirements specified in Table 6.5.2 Required Maximum Noise Levels, with the following additional definitions:

1. **Principal Investigator Office:** Use criteria for executive offices.
2. **Open Laboratory:** Use criteria for open-plan offices.

### 4.3.3 ARF Partitions

The following requirements for ARF partitions are in addition to the minimum requirements indicated in sections 4.3.1 and 4.3.2.

#### 4.3.3.1 General Requirements

**A. Construction:** Partitions used within the ARF boundary shall be constructed of materials that are highly resistant to moisture, chemical, and impact damage. Walls at ARF perimeter, cage wash perimeter and clean/dirty separation and other locations determined by program personnel shall extend up to structure.

**B. Coordination with Program Personnel:** Coordinate with program personnel to determine special chemical resistance, durability, or other performance characteristics of partitions within the ARF boundary.

**C. Wet Area Partitions:** Partitions used within cage wash areas, large animal holding rooms, and other areas subject to wet conditions shall be constructed of materials that are impervious to water and resistant to impact damage by hose streams. Concrete masonry units (CMU) or fiberglass reinforced plastic (FRP) are recommended.

**Figure 4.3.3.5 ARF Wall Protection**



**D. Mock-up:** Construction documents shall require a mock-up of all partitions including all required finish, joint, and corner conditions.

#### 4.3.3.2 ARF Gypsum Wallboard Partitions

Gypsum wallboard within an ARF shall be specialized high impact moisture resistant systems appropriate for ARF environments. Standard commercial systems are not acceptable. Consideration should be given to protecting gypsum wallboard partitions with abuse-resistant glass fiber reinforced finish system. A level 5 gypsum drywall finish system is not permitted.

#### 4.3.3.3 ARF Concrete Masonry Unit Partitions

**A. General:** CMU partitions are preferred by NIH over other types of partitions in cage wash facilities, large animal and primate holding rooms, and other functional spaces that will receive very high physical abuse and be subject to hose stream cleaning.

**B. Block Texture:** CMU utilizing fine sand aggregate or ground face block should be considered to attain a smoother surface for application of high-performance finish systems.

**C. Finished Surface:** CMU partitions within the ARF boundary shall be smooth, impervious to water, and sanitizable, achieved with a minimum of two coats of block filler and an epoxy or other appropriate high-performance coating system.

**D. Sealing CMU Partitions above Ceiling:** Provide solid soap course, fill top course solid with grout or otherwise provide solid, sealed tops to CMU partitions exposed to ceiling plenums. CMU partitions must be detailed and finished to provide a smooth, uniform substrate for a monolithic, non-porous, void-free finish.

#### 4.3.3.4 Concrete Substrate Surfaces

Exposed concrete surfaces shall be cementitously skim-coated or otherwise treated to fill voids and provide a non-porous substrate for finish systems acceptable to the finish system manufacturer.

#### 4.3.3.5 Wall Protection

Provide solid, unpainted corrosion-resistant wall protection rails and corner guards with no concealed voids in all areas subject to damage from transport of carts, caging, materials, or other bulky items. Mounting height of wall protection rails shall be coordinated with program personnel to determine the most beneficial elevation for impact protection. Dual (high-low) rails should be considered in cage wash areas, corridors, and other areas subject to high volume of cage transport. See [Figure 4.3.3.5](#). Extend wall protection rails to protect door frames where possible. Configure wall protection rails to protect wall-mounted items.

#### 4.3.3.6 Corner Guards

Provide corner guards constructed of stainless steel or other material offering equivalent performance acceptable to program personnel at all partition edges exposed to impact from carts, cages, or material transport. Extend corner guards from top of floor base to 1.8 m (6 ft.) above finish floor except where coordination with animal caging requires a higher termination height. Provide rounded profiles conforming to bullnose corners where such corner profiles are used at CMU partitions.

#### 4.3.3.7 Sanitary and Pest Mitigation Features

**A. General:** Design animal facility to protect resident animal population from exposure to insects and rodents; protect against infiltration of pests into the animal facility, and prevent rodent and other small animal populations from escaping their holding rooms. Provide special care in the design of the partitions forming the ARF boundary and for demising partitions between animal holding and procedure rooms.

**B. Sanitary Construction:** Detail partition corners, joints and penetrations so that they are fully and durably sealed. Anchor penetrating items to resist excessive movement that could compromise the seal.

**C. Pest Mitigation:** Cap and seal tops of partitions that are not extended to the underside of the structure or ceiling to resist pest harborage and dust infiltration. Details of partition construction, penetrations and other details shall be reviewed by Integrated Pest Management (IPM) branch for conformance with construction standards and best practices.

#### 4.3.3.8 Sealants

Fill all joints, seams, and junctions between partitions and abutting items with sealant complying with [Appendix L: Sealant Table](#) after application of finish systems.

#### 4.3.3.9 Acoustics

**A. Partitions:** Partitions separating cage wash areas, large animal areas, and other functions that generate undesirable noise from small animal rooms and normally occupied spaces shall be designed to achieve a minimum sound transmission class (STC) of 60 per ASTM E90.

**B. Requirements:** Provide additional acoustic separation as required between animal populations and noise sources as stipulated in the latest edition of the *Guide for the Care and Use of Laboratory Animals* for each species. (Institute for Laboratory Animal Research (ILAR)/National Academy of Sciences [NAS])

# Section 4.4

## Interior Finishes

---

### Contents

#### 4.4.0 Introduction

#### 4.4.1 General Requirements

##### 4.4.1.1 Building Integrity Guidelines

##### 4.4.1.2 Finish Material Selection

##### 4.4.1.3 Life Safety Requirements

##### 4.4.1.4 Sustainability Requirements

#### 4.4.2 Minimum Requirements

##### 4.4.2.1 Floor and Base Finishes

##### 4.4.2.2 Wall Finishes

##### 4.4.2.3 Ceiling Finishes

##### 4.4.2.4 Access Panels

#### 4.4.3 Laboratory Finishes

##### 4.4.3.1 General Requirements

##### 4.4.3.2 Laboratory Floor and Base Finishes

##### 4.4.3.3 Laboratory Wall Finishes

##### 4.4.3.4 Laboratory Ceiling Finishes

#### 4.4.4 ARF Finishes

##### 4.4.4.1 General Requirements

##### 4.4.4.2 ARF Floor and Base Finishes

##### 4.4.4.3 ARF Wall Finishes

##### 4.4.4.4 ARF Ceiling Finishes

##### 4.4.4.5 ARF Access Panels

#### 4.4.5 Wall and Ceiling Finishes for Aseptic Facilities, BSL-3, ABSL-3, and Similar Facilities



## 4.4.0 Introduction

This section includes special requirements for interior finishes for partitions, ceilings, floors, and other interior elements. Refer to [Section 4.5](#) for finish requirements related to casework and millwork.

### 4.4.1 General Requirements

At a minimum, interior finishes shall meet General Services Administration (GSA) Facilities Standards (P100).

Finishes shall be selected to produce a coordinated interior that integrates color, texture, lighting, and other design aspects of the project. Aesthetics shall be considered along with functional requirements, including durability, maintenance, sanitation, and pest control. The final design should be a rational response to the project budget, use, visibility, and programmatic needs and requirements. Lighter colors should be considered to enhance functional lighting levels.

#### 4.4.1.1 Building Integrity Guidelines

Conform to established guidelines for specification of interior finishes for existing campus buildings where applicable. For new building designs, establish guidelines to ensure that future renovations maintain the integrity of the interior design approach in terms of color, consistent use of finish materials, and alteration of casework systems.

**Required Documentation:** Submit color boards including samples of all interior finishes, images of casework, furnishings, lighting, and other visible interior elements for each type of space.

#### 4.4.1.2 Finish Material Selection

Utilize finishes, materials, and other interior elements that can be selected from the current GSA Federal Supply Schedule 56, Buildings and Building Materials/Industrial Services and Supplies.

Select durable finishes that provide value over their useful life and are easily maintained through conventional methods. Limit materials that cannot be repaired

without wholesale replacement. Finish materials shall be free of asbestos and other hazardous materials.

#### 4.4.1.3 Life Safety Requirements

Interior finish materials shall meet the requirements of the International Building Code (IBC), National Fire Protection Association (NFPA), and all other applicable code and standards.

#### 4.4.1.4 Sustainability Requirements

All materials and systems shall be selected to meet the sustainability goals of the project and NIH and Federal sustainability regulations and requirements. See [Section 1.8 Sustainable Design](#).

### 4.4.2 Minimum Requirements

The following minimum requirements are applicable to all NIH funded projects.

#### 4.4.2.1 Floor and Base Finishes

**A. Floor Flatness:** Specify minimum floor flatness and floor levelness tolerances per American Concrete Institute (ACI) 117 standards when the installations of finish materials, functional conditions, or equipment dictate tight control of concrete slab substrates. See [Chapter 5: Structural Design](#). Avoid raised thresholds, steps, or ramps in corridors and other areas used for material transport.

**B. Slip Resistance:** Provide slip-resistant floor surfaces in all areas that may be wet or damp during normal use, including building entryways.

**C. Moisture Protection:** Slope floors to drains in wet areas where allowable; some laboratory programs may prohibit floor drains. Minimum slope, 3 mm per 305mm (1/8 in. per foot).

**D. Floor Finish:** Floor finishes in wet areas shall be seamless with integral coved base. Waterproof membranes shall be coordinated with finish manufacturer requirements.

**E. Walk-Off Mats:** Provide walk-off mats at building entries to extend the life of floor finishes.

**F. Resilient Flooring:** Utilize resilient flooring in break areas, pantries, and other locations subject to spills or staining. Where appropriate, use sustainable products such as linoleum or rubber. Minimum thickness shall be 3 mm (1/8 in.).

**G. Sheet Flooring:** Sheet flooring seams shall be heat welded. Chemical welding is not permitted. Provide integral coved base in areas where seamless sheet flooring is used.

**H. Carpeting:** Provide carpeting as the primary floor surfacing in office and office-support areas.

1. Utilize commercial grade, glued-down synthetic (nylon or equal) carpet tiles or broadloom carpeting, minimum face weight of 40 oz classified for medium to heavy traffic areas.
2. Provide die-cut carpet tiles in areas where access flooring, cellular flooring, or ducted floor systems underlie carpeted surfaces.
3. Carpets and adhesive shall have low volatile organic compound content that meets requirements of the Carpet and Rug Institute (CRI) Green Label Plus program.

Carpet shall not be used in entryways, primary corridors, food service areas, and other locations where floor surfaces are exposed to high traffic or abuse.

**I. Base:** Provide minimum 102 mm (4 in.) continuous base to protect wall finishes.

1. Resilient flooring shall utilize 3 mm (1/8 in.) thick vinyl or rubber cove base adhered with liquid-applied adhesive. Self-stick sectional units are not permitted.
2. Carpeted floors shall utilize 3 mm (1/8 in.) thick straight rubber or a hemmed carpet base. Self-stick sectional units are not permitted.
3. Seal exposed concrete floors.

#### 4.4.2.2 Wall Finishes

**A. Paint:** Low-luster acrylic enamel paint shall be used as the primary interior partition finish. Paint for general interior applications shall be solvent free, water-based, latex paint, and primer. Application shall be a three-coat system including one primer coat and two finish

coats unless specified otherwise. The final coat shall provide a semigloss or eggshell finish, except where more durable finishes are required for functional reasons. Epoxy paint and other specialized coatings are required in areas subject to high humidity, frequent decontamination, impact and wear, and other conditions specified by program requirements.

1. Doors shall be brushed, not rolled. Underwriters Laboratories (UL) labels on fire-rated doors and frames, door hinges, and hardware shall not be painted.
2. New metal surfaces shall be conditioned with metal preparations, and then primed. Primed surfaces are to be sanded prior to finish painting.

**B. Other Materials:** Wood panels, stone, ceramic, and other decorative wall material may be appropriate in lobbies and other high visibility areas. Unfinished concrete or unit masonry may be appropriate in tunnels, mechanical rooms, and other utility spaces.

#### 4.4.2.3 Ceiling Finishes

**A. Acoustic Tile:** Typical ceilings shall be constructed of suspended acoustic tile 610 x 610 mm (2 x 2 ft.) in a standard 24 mm (15/16 in.) grid. Tile in non-lab areas shall be 19 mm (3/4 in.) thick, tegular-edge panels, minimum of 25% to 75% recycled material content, minimum noise reduction coefficient 0.70, minimum light reflectance 0.83, 14 mm (9/16 in.) tee suspension system.

**B. Maintain Symmetry:** Ceilings shall be laid out symmetrically so that grid members, lighting, and other exposed elements maintain modular dimensions.

**C. Height:** Preferred ceiling height is 2.7 m (9 ft.) for open office areas, and 2.4 m (8 ft.) for enclosed offices and office support spaces. The minimum ceiling height shall be 2.4 m (8 ft.).

**D. Spline Ceiling Systems:** Concealed spline ceiling systems requiring special tools for tile removal are not acceptable.

**E. Corridors and Other Areas:** Ceilings installed in corridors and other areas requiring extensive above-ceiling utility access shall be constructed of suspended acoustical tile ceilings to the greatest extent possible.

Equipment, equipment supports, and other heavy items shall be supported by independent assemblies attached directly to the building structure.

**F. Suspended Gypsum Board Ceilings:** Suspended gypsum board ceilings may be used in lobbies and other high visibility areas, for bulkheads, accent areas, or special use areas requiring fire rating, security protection, or other special consideration. Gypsum ceilings may also be required in ARFs, cleanrooms, containment labs and other areas requiring a sealed, monolithic ceiling surface. Where suspended gypsum ceilings are used, provide appropriately located access panels.

**G. Open Ceilings:** Open ceilings (no finished ceiling) may be used in mechanical spaces and other areas that do not require a finished ceiling. They can also be used where desirable because of low structural height or aesthetics. Open ceilings may only be used if ducts, pipes, and other dust-collecting elements are minimized and configured in an orderly manner. Acoustics shall also be a consideration with open ceilings.

Ceilings that require painting shall be finished with a flat sheen.

**H. Moisture Protection:** Provide moisture-resistant ceiling panels and corrosion-resistant suspension system in damp and wet areas.

#### 4.4.2.4 Access Panels

All utility components requiring inspection or adjustment shall be provided with sufficient access to reasonably perform the prescribed maintenance. Where access panels are required, the following parameters shall be met:

- A.** Access panels shall be located in unoccupied areas to the greatest extent possible.
- B.** Access panels shall be located in places that will not be obstructed by fixed casework, equipment or furnishings. Sufficient clear space shall be provided adjacent to access panels to allow for full access to service components.
- C.** Latching mechanisms are preferred over screws for securing the access panel cover.

**D.** Size access panels appropriately for function served. Minimum size for panels serving areas that require full-body access shall be 610 mm x 610 mm (2 ft. x 2 ft.) clear of intruding hardware and door. Panels shall be appropriately sized to allow for comfortable access and working clearances for maintenance staff.

**E.** Panel covers shall be labeled to identify the type of utility they access.

***Rationale:** Access panels are necessary for maintenance of equipment above hard ceilings and in walls. Access panels must be of sufficient size to allow maintenance activities.*

### 4.4.3 Laboratory Finishes

The following requirements for laboratory facility finishes are in addition to the minimum requirements indicated in [Chapter 2: Planning and Programming](#), and other portions of Chapter 4.

#### 4.4.3.1 General Requirements

Laboratory finish requirements shall apply to office and administrative spaces that can only be accessed by passing through laboratory areas.

Finishes shall be smooth, easily sanitized, and resistant to degradation from chemicals and disinfectants commonly used within the laboratory environment. Finishes within laboratories shall be non-porous; including finishes on doors, furniture, casework, flooring, and wall coverings. Some examples of porous finishes include fabric, wood and wood veneer, cork, and carpet. In areas where a wood aesthetic is desired, wood-grain plastic laminate or phenolic resin may provide an acceptable substitute. Where painted finishes are used, provide an eggshell or semigloss sheen to promote sanitation.

Laboratories requiring a very high level of durability and cleanliness shall have a high performance reinforced multi-coat resinous paint finish (reinforced epoxy paint or equivalent). Paint applicators shall be Society for Protective Coatings (SSPC) Coating Application Specialist (CAS Level II) Certified, and must be trained and approved by the paint manufacturer. All

high performance resinous paint applications must be inspected by an independent third party Coating Inspector Program (CIP) level 3 certified inspector.

#### 4.4.3.2 Laboratory Floor and Base Finishes

**A. Installation:** Install floor finishes wall-to-wall, extending under casework and equipment.

**B. Finish:** Floor finishes shall be non-absorbent, allowing for decontamination with liquid disinfectants and spill containment. Vinyl composition tile is the most common flooring used in BSL-2 laboratories. A seamless floor with integral coved base (welded sheet vinyl or epoxy resin) is typically required in specialty or containment labs and labs requiring aseptic conditions. Other floor options may be required by the specific needs of the program, including raised access, static dissipative, and rubber flooring. Sustainability is another criteria for floor selection, but one which should not compromise durability or function.

**C. Carpeting:** Carpeting is not permitted in any area of the laboratory, including office areas that can only be accessed by passing through a laboratory.

#### 4.4.3.3 Laboratory Wall Finishes

**A. Paint:** Low-luster acrylic or latex enamel paint shall be used as the primary interior partition finish. Epoxy paint and other specialized coatings are required in areas subject to high humidity, frequent decontamination, high impact and wear, and other conditions specified by program requirements.

**B. Fabric Finishes:** Wall coverings and fabric finishes on systems furniture, tackboards and other items are not permitted because they may delaminate and will not withstand laboratory conditions.

#### 4.4.3.4 Laboratory Ceiling Finishes

**A. Height:** Minimum ceiling height shall be 2.7 m (9 ft.). Optimal ceiling height is 2.9 m (9 ft. 6 in.). Confirm unusual ceiling height requirements with program.

**B. Acoustical Tile:** Acoustical tile ceilings shall be hydrophobic, smooth surfaced, scrubbable units with a minimum noise reduction coefficient of 0.80. Tegular edges are not permitted.

**C. Open Ceilings (no finished ceiling; exposed structure):** Open ceilings may be acceptable in laboratories under the following conditions:

1. The ceiling structure is concrete or another material that is smooth and uniform and can be painted.
2. The height of the ceiling structure will result in an acoustical tile ceiling that is unacceptably low.
3. Ductwork, conduit and other ceiling-mounted mechanical and electrical items can be minimized, and configured in a way that is neat and visually organized.
4. Acoustics are not a factor or are affectively addressed.
5. The use and function of the laboratory is consistent with an open ceiling.

**D. Moisture Resistance:** Ceiling systems in glassware rooms, autoclave rooms, and other damp and high-humidity locations shall be moisture resistant.

**E. Suspended Gypsum Board:** Suspended gypsum board ceilings may be required in cleanrooms, containment labs, and other areas requiring a monolithic ceiling.

**F. Paint:** Paint may be acrylic enamel or epoxy, depending on the requirements of the program.

### 4.4.4 ARF Finishes

The following requirements for ARF partitions are in addition to the minimum requirements indicated in Sections 4.4.2 and 4.4.3.

#### 4.4.4.1 General Requirements

**A. Abuse Resistant:** Finishes used throughout the operational portion of the ARF shall be abuse resistant, impervious to moisture, and resistant to degradation from chemical disinfectants and decontaminants used within the ARFs environment.

ARF wall and ceiling finishes, unless factory finished, shall have high performance reinforced multi-coat resinous paint finish (reinforced epoxy paint or equivalent). Paint applicators shall be Society for Protective Coatings (SSPC) Coating Application Specialist (CAS Level II) Certified, and must be trained and approved by the paint manufacturer. All high performance resinous paint applications must be inspected by an independent third party Coating Inspector Program (CIP) level 3 certified inspector.

All products shall have a documented five year history of successful use in ARFs and similar demanding environments.

**B. Mock-Ups:** Mock-ups shall be provided for all ARF projects. Mock-ups shall include sections of all finish materials and systems (paint, flooring, base, sealants, door frames, access panels, cover plates, wall protection, etc.), in all typical conditions (inside and outside corners, base/wall junction, wall/ceiling junction, etc.). Mock-ups shall be approved by the PO, program personnel and other stakeholders, and shall be maintained as a reference for minimum level of quality and workmanship.

***Rationale:** Mock-ups provide a baseline level of quality and performance and an opportunity to test and approve details, aesthetics, compatibility, and other aspects of the systems prior to actual installation.*

**C. Installers:** Installers shall be certified and trained by the manufacturers, and shall demonstrate experience and mastery of the application process.

#### 4.4.4.2 ARF Floor and Base Finishes

**A. Finish:** Floor finishes shall be monolithic and non-porous with integral coved base and capable of supporting regular wheeled loads of 272 kg (600 lb) from the movement and placement of heavy cages, equipment, and carts without damage and degradation.

**B. Seamless Finish:** Seamless resilient floor finishes may only be used if they are warranted to resist degradation from 272 kg (600 lb) wheeled carts and caging.

**C.** All floors shall incorporate an integral coved base 152 mm (6 in.) minimum height. For walls constructed of gypsum wall board, the base shall be backed with

a non-gypsum-based, cementitious board complying with ASTM C1288 or coated glass mat water-resistant gypsum backing panel as defined in ASTM C1178 to provide durability and water resistance.

##### 4.4.4.2.1 High-Performance Resinous Flooring System

High-performance resinous flooring systems are required in all ARF areas subject to high traffic, wheeled caging and frequent wash down, including main corridors, cage wash and holding rooms. Composition, thickness, top coat, texture and skid resistance are dictated by the functional requirements of the space they serve. The following minimum requirements apply in addition to the manufacturer's installation requirements:

**A. Surface Preparation:** Existing substrates shall be inspected and all delaminated or degraded areas removed and repaired prior to finish application. Floor substrate shall be scarified to achieve conditions specified by the manufacturer. A representative of the flooring manufacturer shall provide detailed requirements for the substrate (including but not limited to chemical composition, moisture content, surface preparation and texture) and shall inspect the site prior to installation and certify that all required conditions and requirements have been met.

**B. New slabs on grade:** New slabs on-grade scheduled to receive high-performance floor finishes shall be protected by continuous, overlapping, taped under-slab vapor barriers.

**C. Substrates:** New and existing substrates shall be tested for moisture content utilizing ASTM F-1869 (calcium chloride test) and ASTM-D-4263 (plastic sheet test) to ensure compliance with manufacturer's limitations immediately prior to finish application. Where limitations are exceeded, a waterproof membrane or other remediation acceptable to the manufacturer shall be specified.

**D. System Thickness:** Minimum system thickness shall be 3 mm (1/8 in.), except in large animal rooms, cage wash areas, and other areas subject to high abuse or thermal movement. Minimum thickness in these areas shall be 5–6 mm (3/16–1/4 in.).

**E. Samples and Mock-ups:** Floor texture and skid



resistance shall be established by the design team, and confirmed through approval of samples and on-site mock-up. Provide mock-ups for each finish system and typical detail to establish a minimum level of quality and workmanship.

**F. Certifications:** Mechanics installing the flooring shall be certified to have a minimum of five years' experience installing similar systems.

#### 4.4.4.2.2 Floor Base

Minimum base height shall be 152 mm (6 in.). A solid, monolithic base or curb shall be provided to support fixed, floor-mounted casework and lockers so that the floor base can be extended around them. Base height in these areas may be reduced to 102 mm (4 in.).

**Figure 4.4.4.2.2 Integral Cove Base Detail**



Consideration should be given to a seamless base detail for resinous floor and wall installations in which the wall coating is extended over a tapered base providing a seamless transition between base and wall. Confirm compatibility of products and provide mock-up for approval. See [Figure 4.4.4.2.2](#).

#### 4.4.4.3 ARF Wall Finishes

**A. Finish:** High-performance wall finish systems are required in operational areas of the ARF.

**B. Paint:** A high solid, multicomponent epoxy paint or similar product that is durable, impact resistant,

waterproof, chemical resistant, and has a successful record of use in ARFs and other demanding environments shall be used.

#### 4.4.4.3.1 Coating Systems

Composition and thickness of coating systems are dictated by the functional requirements of the space they serve. The following minimum requirements apply in addition to the manufacturer's installation requirements:

**A. Masonry and concrete surfaces:** Masonry and concrete surfaces shall be prepared to obtain a smooth substrate for high-performance finishes. Uneven areas and voids shall be filled, rough areas smoothed, and a minimum of two coats of block filler applied to provide a non-porous substrate free of pinholes in outer coatings.

**B. Dry-film Thickness:** Minimum dry-film thickness after substrate preparation shall be 0.25 mm (10 mils), but not less than manufacturer's recommendations.

**C. Coating:** Apply high-performance coatings prior to application of sealant at joints prone to movement.

**D. High Abuse Areas:** Glass-fiber-reinforced finish should be considered to enhance the impact resistance of gypsum wallboard partitions in high abuse areas.

**E. Mock-ups:** Provide field-installed mock-ups for each finish system to establish a minimum level of quality and workmanship.

#### 4.4.4.3.2 Panelized and Sheet Wall Systems

Fiberglass reinforced polymer (FRP) panel and other moisture-, chemical-, and abuse-resistant sheet or panel wall systems are acceptable provided that seams and fasteners are fully gasketed and sealed, and the system is adequately supported to prevent sagging and/or delamination.

#### 4.4.4.4 ARF Ceiling Finishes

Monolithic ceilings with high-performance finish systems are required in operational areas of the ARF.

*Exception: Panelized systems may be provided in areas where utility access cannot be achieved with a monolithic system provided that panel joints are fully sealed.*



#### 4.4.4.4.1 Coating Systems

Composition and thickness of coating systems are dictated by the functional requirements of the space they serve. The following minimum requirements apply in addition to the manufacturer's installation requirements:

**A. Dry-film Thickness:** Minimum dry-film thickness after substrate preparation shall be 0.25 mm (10 mils), but not less than manufacturer's recommendations.

**B. Coating:** Apply high-performance coatings prior to application of sealant at joints prone to movement.

#### 4.4.4.4.2 Suspended Panel Systems

The use of FRP panel and other moisture- and chemical-resistant panel systems must be approved by program personnel, and must have fully gasketed and sealed seams and fasteners, and the system must be adequately supported to prevent sagging and/or delamination. Where accessible, suspended tile panel systems are used, provide heavy-duty corrosion-resistant, gasketed grid and hold-down clips that result in compression of the gasket around the entire perimeter of each panel. Hold-down clip design shall allow for panel removal without damage to the ceiling system in areas where utility access is required.

#### 4.4.4.4.5 ARF Access Panels

**A. Location:** Locate access panels in corridors and other non-operational areas to the greatest extent possible. Access panels shall not be located in animal holding rooms.

**B. Construction:** Access panels shall be constructed of stainless steel or other uncoated corrosion resistant material.

**C. Continuous Door Gasket:** Access panels shall be fitted with a continuous air tight door gasket. Panel design shall ensure compression of the gasket around the entire panel door perimeter without discontinuity at the hinge or latch when in the closed position.

### 4.4.5 Wall and Ceiling Finishes for Aseptic Facilities, BSL-3, ABSL-3, and Similar Facilities

All surface finishes shall be selected to be compatible with the anticipated agents and methods used for cleaning, disinfection or sterilization and protocols used by program without damage or degradation, including discoloration. Materials selected shall have a proven, tested record of performance with the chemical agents listed below, as well as all agents identified by the program that will be used in the facility. Testing shall be performed for agents individually and in combination. If a record of performance with agents is not available a mock-up test shall be conducted, documented and passed prior to selection.

Surface finishes shall not be selected based on first-cost, but on life-cycle cost basis for the facility. Systems shall be impact resistant and shall have smooth, sealed joints and transitions, eased outside corners and coved inside corners.

All materials shall resist damage due to exposure to heat and humidity as anticipated to be encountered in the life cycle of the project to at or above highest temperature without degradation below minimum service level for the application.

All finish material selections shall exhibit mold and mildew resistance properties. Products shall be installed over cellulose-free (inorganic-faced) substrates only.

Provide impact-resistant wall system, including protection and components.

**A. Panelized Composite Systems:** Panelized composite wall and ceiling systems are preferred due to their controlled-environment manufacturing, design versatility, chemical resistance, pressure/airflow resistance, and pre-engineered details.

1. Installation must be by certified installers.
2. Substrate material and detailing must be inspected and certified as acceptable by the manufacturer.

3. Adhesives, sealants and all other system components must be as chemical resistant as system panels.
4. Panel Systems shall be Class “A” Fire Rated both as a composite assembly and for the surface alone.

**B. High Performance Reinforced Multi-coat Resinous Paint Finish:** High performance reinforced multi-coat resinous paint finish on impact, water and mold-resistant substrate may be considered if there are functional advantages over panelized systems and if approved by ORF and the program.

1. Paint applicators shall be Society for Protective Coatings (SSPC) Coating Application Specialist (CAS Level II) Certified, and must be trained and approved by the paint system manufacturer for the application of the specific products and techniques required for the application of products per the manufacturer’s recommendations and requirements.
2. Paint manufacturers must inspect and certify acceptable site conditions, including environmental conditions and the condition of the substrate prior to application.
3. Daily logs of the application must be maintained, including mixture and cure rates.
4. Cure times, temperature and humidity, consistency of application, protection and other manufacturer requirements shall be strictly maintained.

5. All high performance resinous paint applications must be inspected by an independent third party Coating Inspector Program (CIP) level 3 certified inspector. This inspector shall record environmental conditions, testing locations, and wet film thickness, as the work progresses.
6. Finish shall be Class “A” Fire Rated.
7. All coating components shall be by the same manufacturer, to the extent practicable.
8. Masonry and concrete walls may be treated with block fillers, surfacers, and other system components to achieve an acceptable level of substrate for non-aseptic production facility wall. These substrates will not be deemed as acceptable substrates for aseptic production facilities.

**C. Surface Test Chemical List:** Surfaces shall be tested to the following chemicals in addition to all chemicals identified by the program who will use the facility:

1. Chlorine dioxide
2. 70% Isopropyl Alcohol
3. Vaporized Hydrogen Peroxide
4. Process LpH®
5. Vesphene IIse®
6. Peridox RTU®
7. Sporklenz®

# Section 4.5

## Casework and Millwork

---

### Contents

#### 4.5.0 Introduction

#### 4.5.1 General Requirements

##### 4.5.1.1 Accessibility Requirements

##### 4.5.1.2 Life Safety Requirements

##### 4.5.1.3 Structural Requirements

##### 4.5.1.4 Pest Control Requirements

#### 4.5.2 General Use Casework and Millwork

##### 4.5.2.1 Millwork

##### 4.5.2.2 Plastic Laminate Countertops and Shelving

#### 4.5.3 Laboratory Casework

##### 4.5.3.1 Casework and Shelving

##### 4.5.3.2 Flammable Storage Cabinets and Waste Containers

##### 4.5.3.3 Task Lighting

##### 4.5.3.4 Sinks

##### 4.5.3.5 Safety Devices

#### 4.5.4 ARF Casework

## 4.5.0 Introduction

This section includes requirements for casework and millwork. Casework and millwork include fixed and mobile cabinets, shelving, countertops, and accessories. Casework is critical to the function and operation of a laboratory and is a major cost contributor of a lab fit-out. Casework must withstand chemicals, provide a stable base for heavy equipment, and be flexible and modular to respond to the changes in scientific processes. Discussions of specific research requirements during the planning process will inform decisions regarding casework and millwork selection.

## 4.5.1 General Requirements

### 4.5.1.1 Accessibility Requirements

See Section 1.9 Accessibility, for general accessibility requirements.

### 4.5.1.2 Life Safety Requirements

**A. Shelving Height Restrictions:** Shelving height shall not exceed 2.3 m (7 ft. 6 in.) above finished floor for safe reaching.

**B. Peninsula and Island Shelving:** Peninsula and island shelving height shall be limited to 762 mm (2 ft. 6 in.) below sprinkler deflectors so that material stored on the top shelf does not obstruct sprinkler coverage.

*Exception: This height restriction does not apply when sprinklers located on both sides of the shelving provide required coverage without relying on water dispersion over the top of shelving.*

### 4.5.1.3 Structural Requirements

**A. Seismic Requirements:** Comply with IBC requirements for restraint and anchorage of casework, millwork, and shelving in accordance with the applicable seismic zone.

**B. Cabinets:** Construction drawings shall indicate how wall cabinets and base cabinets are attached to the partitions. Where cabinets with recessed backs are used,

solid or slotted horizontal steel angles, minimum 15 gauge shall be provided for support.

**C. Shelving:** Shelving and shelving supports shall be designed to carry a minimum design load of 23 kg per 305 mm (50 lb. per linear foot) for typical, 305 mm (1 ft.) deep shelving. Shelving in excess of 305 mm (1 ft.) deep shall be designed for proportionally greater loading, and all components of the system (including brackets, anchors, wall framing, strapping) shall be specifically designed for that loading. Maximum deflection shall be 6.35 mm (1/4 in.) per 914 mm (3 ft.).

Anchorage of vertical standards carrying shelving brackets shall be capable of carrying a fully loaded wall of shelving consisting of a top shelf no higher than 2.3 m (7 ft. 6 in.) above the floor with shelves spaced 305 mm (1 ft.) apart below the top shelf all the way to the floor or countertop. A fully loaded wall assumes all shelves are loaded to capacity.

1. Maximum shelving support spacing shall be 914 mm (3 ft.). Manufactured systems with shelving support spacing exceeding 914 mm (3 ft.) shall be certified to carry minimum design loads.

**D. Countertops:** Brackets for wall-mounted cantilevered casework and countertops shall be designed to support general loading of 244 kg per m<sup>2</sup> (50 lbs per ft<sup>2</sup>). Countertops carrying equipment that imposes higher loads shall be designed for the specific application.

1. Maximum spacing for countertop supports shall be 1.2 m (4 ft.). Maximum cantilevered distance between the end support and edge of counter shall not exceed 305 mm (1 ft.). Manufactured systems with countertop support spacing exceeding 1.2 m (4 ft.) shall be certified to carry minimum design loads.
2. Structural engineering calculations and details shall be submitted to certify the adequacy of brackets, anchors, and partitions supporting cantilevered countertop systems. Maximum deflection shall be 6.35 mm per 914 mm (1/4 in. per 3 ft.).

#### 4.5.1.4 Pest Control Requirements

Fixed millwork, casework, and countertops shall either be sealed to walls and floors or positioned with sufficient spacing to facilitate cleaning and minimize harborage of pests. See [Section 1.12 Integrated Pest Management](#).

## 4.5.2 General Use Casework and Millwork

### 4.5.2.1 Millwork

**A. Construction:** Millwork shall be fabricated with premium-grade construction fabricated per the Architectural Woodwork Standards (AWS).

**B. Cabinets:** Custom built-in cabinets that are fixed and inflexible should be minimized within non-public spaces. Use of manufactured products or furnishings that are reconfigurable is recommended.

1. Cabinet hardware shall comply with ANSI A156.9, American National Standard for Cabinet Hardware. Drawer slides shall be side-mounted, full-extension type rated for intended use, but in no case carrying less than a 57 kg (125 lb.) load rating. File drawer slides shall carry a minimum 68 kg (150 lb.) load rating, and allow for full drawer extension.

### 4.5.2.2 Plastic Laminate Countertops and Shelving

**A. Core Material:** Plastic laminate faced (PLF) countertops shall be constructed of 25 mm (1 in.) thick plywood or 38 mm (1-1/2 in.) thick high-density particleboard. PLF shelving shall be constructed of 19 mm (3/4 in.) thick plywood or 25 mm (1 in.) thick high-density particleboard.

**Figure 4.5.2.2 Grommet Detail**

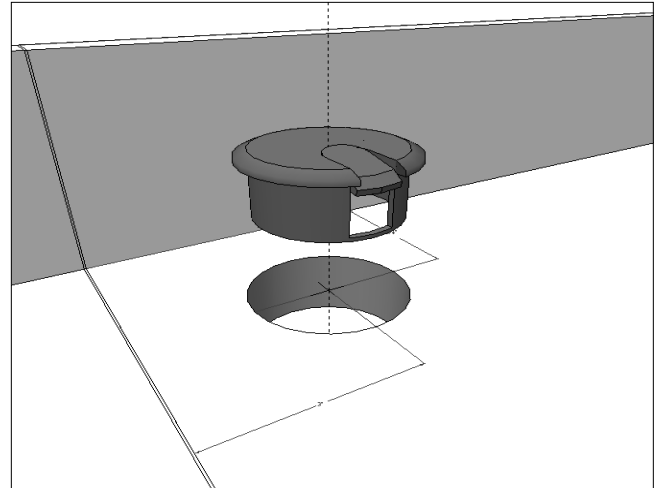

**B. Plastic Laminate Facing:** Provide 1.6 mm (1/16 in.) general purpose high-pressure decorative laminate surfacing at all faces of shelving, and all exposed faces of countertops. Provide laminate backer sheet on underside of countertop and other faces not exposed to view.

**C. Openings:** Drilled or cored openings in the work surfaces shall be fitted with grommets to accommodate cabling and sized to the opening for wire management. See [Figure 4.5.2.2](#).

## 4.5.3 Laboratory Casework

The following requirements for laboratory casework are in addition to the minimum requirements indicated in [Section 4.5.2 General Use Casework and Millwork](#).

### 4.5.3.1 Casework and Shelving

Laboratory casework shall comply with Scientific Equipment and Furniture Association (SEFA) standards. Minimum level of quality for casework systems, countertops, and accessories shall be established by the NIH Laboratory Casework Specifications. Alternate systems for specific applications may be approved by the PO on a per project basis.

Floor supported systems that do not require anchorage through the ceiling are recommended to enhance flexibility. See [Figure 4.5.3.1](#). Tables, mobile pedestals and other 'loose' items can be used to increase flexibility if compatible with the research program.

**Figure 4.5.3.1 Typical Lab & Casework**

**A. Materials:** Provide modular steel casework free of sharp corners and edges.

*Exception: Provide stainless steel, phenolic, or polycarbonate resin casework in damp or wet locations and corrosive environments.*

**B. Finish:** Steel casework shall be provided with SEFA 8 compliant chemical and physical resistant urethane powder coat finish.

**C. Modularity:** Cabinets and shelving components shall be interchangeable and readily available for easy reconfiguration.

**D. Countertops:** Recommended minimum counter depth shall be 762 mm (2 ft. 6 in.) at walls and 1.5 m (5 ft.) at peninsulas and islands.

1. Provide back and side splashes of matching material where countertops abut walls.
2. Provide a 25 mm (1 in.) minimum overhang with drip groove beneath the front edge.
3. Provide grommets as required at low (762 mm [2 ft. 6 in.]) bench. Provide grommet covers. Grommets are not allowed in high (914 mm [3 ft.]) bench.
4. Provide splash guards, minimum 305 mm (1 ft.) in height to protect low-bench users from spills and spray at transitions between high- and low bench sections and to isolate sink areas from adjacent work areas.

**E. Countertop Material:** Countertops shall be constructed of smooth, impervious, easily sanitized materials resistant to heat and cleaning and laboratory chemicals. Countertop materials may vary depending on type of research and laboratory use.

1. Chemical-resistant plastic laminate faced (PLF) countertops may be used for low intensity applications and dry labs where use of chemicals, reagents, and disinfectants is moderate. PLF countertops may not be used at sink and other wet locations.
2. Plastic laminate grade shall be horizontal grade postform (HGP) and comply with National Electrical Manufacturers Association (NEMA) NEMA LD 3 test procedure 3.9.5 with no effect from typical reagents.
3. Epoxy or phenolic resin countertops shall be used in laboratories where more intensive use of chemicals, reagents, and harsh disinfectants is anticipated.
4. Phenolic resin countertop composite top material shall be compact laminate grade (CGS) laminate and comply with NEMA LD 3 test procedure 3.9.5 with no effect from typical reagents.
5. Epoxy countertops shall be used for synthetic chemistry laboratories and other applications requiring the use of corrosive chemicals.
6. Stainless steel or phenolic resin shall be used for glassware wash areas, cold rooms, and other areas where high moisture levels are anticipated.
7. Stainless steel shall be used in areas requiring aseptic conditions.
8. Other countertop materials may be considered if justification of durability and cost-effectiveness is submitted and approved.

**F. Knee-holes:** Knee-holes and open areas under high bench countertops shall be designed with removable back panels.

1. Minimum knee-hole opening clearance shall be 635 mm wide x 876 mm high (2 ft. 1 in. wide x 2 ft. 10-1/2 in. high) to receive undercounter equipment. 762 mm (2 ft. 6 in.) width is recommended at user lab stools.



2. Back panels shall be sufficiently recessed for placement of under counter refrigerators and freezers.
3. Knee-holes shall provide adequate clearance for researcher-specified equipment.

**G. Electrical Receptacles:** Undercounter electrical receptacles shall be configured to allow for removal of the back panel without electrical alterations.

**H. Panels:** Panels shall not be used to seal voids in BSL-3 or greater laboratory environments.

**I. Shelving:** Shelving shall be adjustable in height; however, adjustment tolerances shall not exceed maximum height limits listed in [Section 4.5.1.2](#).

1. Provide horizontal end and back shelf guards, 102 mm (4 in.) minimum height where shelves do not abut walls or other shelves. See [Figure 4.5.3](#).
2. Front retention bar or lip is not required unless mandated by code for seismic protection.

#### 4.5.3.2 Flammable Storage Cabinets and Waste Containers

Flammable chemical storage cabinets shall be placed in every laboratory. Space shall be allocated and identified in all laboratories for medical pathological waste (MPW) placement. Flammable storage cabinets shall not be located under fume hoods or in a location potentially hazardous to occupants (e.g., near door, near desk area, in high-traffic aisle). Refer to [Section 9.1.6 Flammable Liquid Storage Cabinets](#) for additional requirements.

#### 4.5.3.3 Task Lighting

Task lighting at the lab bench shall be incorporated into the overall laboratory lighting strategy. Refer to [Chapter 10: Electrical Design](#), for additional requirements.

#### 4.5.3.4 Sinks

**A. Construction:** Laboratory sinks shall be epoxy or stainless steel to facilitate the decontamination of surfaces. Sinks shall be detailed in a manner to eliminate crevices where bacteria can grow or pests can harbor. Refer to [Section 8.2 Plumbing Fixtures and Equipment](#) for additional requirements.

**B. Cupsinks:** Cup sinks shall not be installed in lab benches unless specifically required by the research program. The use of cupsinks is allowed in chemical fume hoods when required by the research program and approved by DOHS. When used in fume hoods, cupsinks shall be provided with a 5 mm (1/5 in.) raised rim to prevent chemicals from reaching the waste stream in the event of a spill.

*Rationale: Cup sinks require maintenance if not used on a regular basis.*

**C. Marine Edge:** Consider detailing a marine edge on the sink countertop surface to encourage the flow of water into the sink.

**D. Splash Guard:** Acrylic splash guards shall be located adjacent to sink areas to prevent the propagation of water onto adjacent lab benches.

**E. Sink Design:** Sink design shall accommodate the requirements of the specific research. Provide hands-free operation via foot pedals or automatic sensors. See [Chapter 8: Plumbing Design](#) for additional information and requirements.

**F. Shelf:** Provide a shelf mounted above the sink with a building pure water supply connection and dedicated power outlet to accommodate the point of use purification system. Coordinate this requirement with research needs. Even if not required, consider providing this accommodation at a number of sinks for future use and flexibility.

**Figure 4.5.3 Typical Lab Shelf & Flanges**

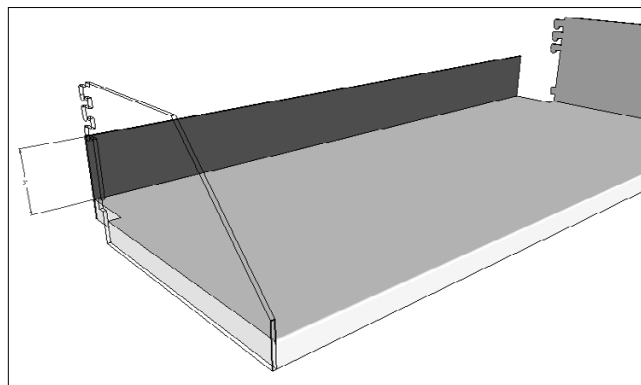

### 4.5.3.5 Safety Devices

General placement requirements are noted in this section. Final locations and details shall be approved by the AHJ and DOHS. See also [Section 4.6 Furnishings and Equipment](#) as well as [Chapter 8: Plumbing Design](#), for additional information and requirements.

**A. Eyewash Equipment:** Eyewash stations shall be located at all lab sinks, or as approved by the DOHS. The detailing of the eyewash mounting at the sink shall ensure the eyewash is properly placed to allow researcher use of the hot- or cold-water faucet, and pure water faucet, but still be easily accessible for emergency use. The eyewash shall be located so the rinse water is captured by the sink.

**B. Emergency Showers:** Emergency showers are required per code and in any space where chemicals or corrosives are handled, which includes cage wash rooms as well as labs. Emergency showers shall meet the most current version of ANSI Z358.1 for all locations and detail requirements.

**C. Fire Extinguisher Cabinets:** Comply with the requirements of [Section 9.1 Fire Protection Systems](#).

---

## 4.5.4 ARF Casework

The following requirements for ARF casework are in addition to the minimum requirements indicated in [4.5.2 General Use Casework and Millwork](#), and [4.5.3 Laboratory Casework](#).

**A. Casework and Shelving Systems:** Use of fixed casework in ARFs should be minimized to enhance sanitation and flexibility. Loose tables, mobile casework systems, or cantilevered countertops and mobile base cabinets are generally preferred to facilitate sanitation and eliminate inaccessible areas that cannot be cleaned or treated for pest control.

1. Provide stainless steel casework, shelving, and components in surgery areas, necropsy rooms, and other locations with aseptic requirements.
2. Where fixed, floor-mounted cabinets are used, provide a solid base suitable for receiving an integral cove base extended around cabinetry.
3. Stainless steel or phenolic resin cabinetry and components should be considered for resistance to frequent use of harsh disinfectants. Plastic laminate is not acceptable in ARFs.
4. Wall-mounted upper cabinets and lockers shall be equipped with sloped tops.
5. Shelving standards shall be open fronted or otherwise detailed to allow for full sanitation. Slotted standards with inaccessible concealed areas are not recommended. Fixed shelf brackets may be considered.

**B. Countertops:** Epoxy, stainless steel, or phenolic countertops are acceptable. Other materials may be considered if justification of durability and function is submitted and approved. Plastic laminate is not acceptable.

1. Provide stainless steel countertops in surgery areas, necropsy rooms, and other locations with aseptic requirements. Sound deadening material or coatings are not allowed on the underside of stainless steel counters in aseptic areas or areas requiring surface decontamination.

# Section 4.6

## Furnishings and Equipment

---

### Contents

#### 4.6.0 Introduction

#### 4.6.1 General Requirements

##### 4.6.1.1 Accessibility Requirements

##### 4.6.1.2 Sustainability Requirements

##### 4.6.1.3 Structural Requirements

##### 4.6.1.4 Documentation Requirements

##### 4.6.1.5 Transportation Route

##### 4.6.1.6 General-Use Fixed Equipment

##### 4.6.1.7 Mail Distribution Equipment

##### 4.6.1.8 Fire Extinguisher Cabinets

##### 4.6.1.9 Systems Furniture

##### 4.6.1.10 Chemical Fume Hoods

##### 4.6.1.11 Biological Safety Cabinets

##### 4.6.1.12 Autoclaves

##### 4.6.1.13 Ice Machines & Dry Ice Bins

##### 4.6.1.14 Special Equipment

##### 4.6.1.15 Lab Movable Equipment

###### 4.6.1.15.1 Flammable Storage Refrigerators/ Freezers

###### 4.6.1.15.2 Explosion Proof Refrigerators/ Freezers

#### 4.6.2 ARF Equipment and Furnishings

##### 4.6.2.1 ARF Fixed Equipment

##### 4.6.2.2 ARF Movable Equipment and Furnishings

## 4.6.0 Introduction

This section includes requirements for furnishings and equipment. Furnishings and equipment include fixed and movable equipment, systems furniture, and modular furniture.

### 4.6.1 General Requirements

All furnishing and equipment related requirements within the project scope shall be coordinated regardless of the government funding source.

Specified furnishings and equipment shall be ergonomic to prevent personnel fatigue and workplace injuries.

#### 4.6.1.1 Accessibility Requirements

Comply with [Section 1.9 Accessibility](#) for general accessibility requirements.

#### 4.6.1.2 Sustainability Requirements

Comply with [Section 1.8 Sustainable Design](#) for general sustainability requirements.

Specification of ENERGY STAR, water saving, and energy-saving equipment shall be strongly considered unless performance or safety is compromised.

#### 4.6.1.3 Structural Requirements

Where weight of equipment exceeds live load capacity of the slab or structural modifications are required, provide engineering drawings and calculations. In addition, where structural depressions are required for drains or ramps, engineering drawings and calculations shall also be provided.

See [Chapter 5: Structural Design](#), for load capacity, vibration isolation, and vibration performance requirements.

#### 4.6.1.4 Documentation Requirements

Equipment planning is integral to the planning of the architectural, structural, mechanical, electrical, and plumbing systems. An equipment schedule shall be developed during predesign and updated through construction document development. See [Appendix G: Sample Equipment Schedule](#) for a sample equipment schedule.

Planning considerations shall include clearances for service and ventilation and maintenance access with minimum disruption to work spaces; provisions for additional equipment, and future expansion of equipment areas.

#### A. Design Phase:

1. Catalog cut sheets shall be provided for all equipment.
2. An equipment schedule shall be provided for every project.
3. Party responsible for the furnishing and installation shall be provided.
4. Location of service areas and clearances shall be identified on the construction drawings.
5. Path of travel from point of delivery to final destination for oversized and overweight pieces of equipment (i.e., NMR magnets) shall be illustrated and included as a drawing sheet.
6. Equipment plan and schedules shall state if vendor/ trade support is needed upon delivery.
7. Equipment clearances shall be illustrated on the equipment plans accommodating the worst-case requirements. All specified manufacturers should be accommodated in design clearances and utility accommodation, not just the basis of design manufacturer.
8. Equipment performance specifications for contractor-furnished equipment should clearly indicate responsibilities of the contractor, owner, and the NIH.

**Note:** The NIH has guide specifications for some equipment which should be used, unless otherwise directed by the project officer (PO).

9. Mechanical, electrical, plumbing, refer to [Chapter 6: Mechanical Design](#), [Chapter 8: Plumbing Design](#), [Chapter 10: Electrical Design](#), and [Chapter 12: Special Process Piping Systems](#), for additional requirements related to specification of equipment that is to be served by building HVAC, plumbing and electrical systems.

10. Researcher shall provide the A/E an initial list of equipment to facilitate planning and design, in addition to any site planning guides for large equipment.

**B. Construction Phase:** Submittals for fixed equipment including product cut sheets and installation shop drawings, shall be reviewed for compliance with contract documents. The equipment user shall review specialty fixed equipment submittals to ensure options and accessories are appropriate for the project application. In addition, the designer, equipment user, and PO shall review all movable equipment to ensure that models that have changed during the design process can be accommodated at time of delivery.

#### 4.6.1.5 Transportation Route

Delivery pathway through the building, both horizontal and vertical, must be verified during the design phase to ensure adequate route is available for equipment components or pallets. Doors, elevators, corridors, areaways, parking areas, loading docks, entrances, and all other components of the route shall be of adequate size and load-bearing capacity to accommodate the installation or replacement of large equipment. Assessment shall include turning radii, clearance for rigging, and notation of any actions that will be required (i.e., removing doors from frames, removing light fixtures).

*Rationale: Costly, disruptive modifications to the building should not be necessary to deliver or remove large equipment in or out of the building.*

#### 4.6.1.6 General-Use Fixed Equipment

Equipment shall be flush, wall-recessed, or through-wall types to the greatest extent possible where sanitation or aseptic requirements dictate.

#### 4.6.1.7 Mail Distribution Equipment

**A. Mail Cluster Boxes:** The NIH Division of Mail Management Services (DMMS) requires the use of mail cluster boxes in lieu of door-to-door mail for delivery of mail to NIH customers in a building. Mail cluster boxes shall be installed at a ratio of one per every fifty building occupants. Mail cluster boxes shall be centralized in the building lobby, but may be decentralized to

a single location on each building floor when approved by the DMMS.

Cluster boxes shall be wall-mounted, front-loading units with rear covers. Wall-mounted cluster boxes shall be thoroughly secured to the building structure. Each unit shall be not less than 305 mm wide × 305 mm high × 406 mm deep (12 in. × 12 in. × 16 in.). Each cluster box shall be marked with self-adhesive numbers inside and outside individual mailboxes to identify the recipient's mail stop code (MSC), as directed by the DMMS. The construction of the cluster boxes shall meet or exceed the U.S. Postal Service (USPS) specifications. Each cluster box door shall be secured with a cylinder cam lock, keyed individually, and master-keyed (three keys required) for DMMS use.

**B. Mail Drop Boxes:** Two secured mail drop boxes are required at each mail cluster box bank to support outgoing mail services. The first one shall be used for outgoing interoffice mail, and the second for outgoing USPS official domestic and foreign mail.

Drop boxes shall be wall-mounted, front-loading units and have a rear cover. The interior of these mail drop boxes shall be sized not less than 457 mm wide × 762 mm high × 457 mm deep (18 in. × 30 in. × 18 in.). Each drop box shall have a mail slot protected with gravity or spring loaded flap size not less than 381 mm wide × 102 mm high (15 in. × 4 in.). These drop boxes shall be secured with cylinder cam locks and be master-keyed (two keys required). Drop-box construction shall meet or exceed USPS specifications. At each location, one box shall be marked "Interoffice Mail" and the other marked "Official Mail."

#### 4.6.1.8 Fire Extinguisher Cabinets

See [Chapter 9: Fire Protection & Suppression](#), for DFM requirements for fire extinguisher cabinets.

#### 4.6.1.9 Systems Furniture

The following requirements for systems furniture are in addition to the minimum requirements indicated above.

**A. Flame Spread Requirements:** The flame spread requirements of the NFPA Life Safety Code shall be applied to prefabricated panel furniture systems when such panels are ceiling high or extend sufficiently close

to the ceiling so that the large space divided by the panels is considered to be multiple rooms.

The flame spread requirements of the NFPA Life Safety Code should not be applied to prefabricated panel furniture systems when such panels do not sufficiently extend close to the ceiling so that the large space divided by the panels is considered to be a single room.

The application of flame spread requirements to prefabricated furniture panels does not override any requirements concerning the combustibility of the panels as may be governed by other standards.

**B. Responsibility:** Final decisions regarding the interpretation and application of the NFPA Life Safety Code with regard to all aspects of systems furniture shall be made by the AHJ.

**C. Wiring:** The wiring systems and requirements of systems furniture shall be determined and coordinated as early as possible in the design process.

#### 4.6.1.10 Chemical Fume Hoods

In the early stages of lab planning, the A/E must have a thorough discussion with scientists regarding the purpose and use of each chemical fume hood.

**A. Specifications:** All fume hoods shall comply with NIH Guide Specifications.

**B. Placement:** Fume hood placement in laboratories shall comply with that outlined in *Methodology for Optimization of Laboratory Hood Containment, Volumes I & II, November 1996, Office of the Director, ORF Publication* (<http://orf.od.nih.gov/PoliciesAndGuidelines/Bioenvironmental/Pages/lab-hoodcontainm.aspx>) and be approved by the Division of Occupational Health and Safety (DOHS).

1. DOHS must be consulted prior to removal of a fume hood.
2. Fume hoods shall be located as far away from the egress door and laboratory traffic patterns as possible. Fume hoods shall be located away from the exhaust and supply diffusers and any other items that could be a source of turbulence.

3. Fume hoods may not be located adjacent to or across from desk/computer workstations.
4. Fume hoods may not block the path of egress, or be placed where it may create a safety hazard to the lab occupant.
5. Cup sinks should be located in the rear of the fume hood, if needed. Fume hood piping and backflow protection arrangements shall conform to requirements [Section 8.2 Plumbing Fixtures and Equipment](#).
6. Fume hoods for radionuclide use shall be designed in accordance with the following industry criteria and technical specifications:
  - a. Landis and GYR Powers, Inc., *Solutions Application Guide, 1993*.
  - b. *Industrial Ventilation: A Manual for Recommended Practice for Design* (current edition; American Conference of Governmental Industrial Hygienists, Cincinnati, OH).
  - c. Hoods shall have a minimum face velocity of .5 m/s (100 ft./min).
  - d. A typical fume hood designed for hazardous materials is acceptable as a radioisotope fume hood.
  - e. Fume hood design shall include smooth, non-porous surfaces for ease of decontamination.
  - f. The fume hood shall be constructed of materials that will not generate mixed waste if the surfaces and the construction materials interact with the radioactive materials.
7. Fume hoods shall comply with requirements listed in [4.5.3.2 Flammable Storage Cabinets and Waste Containers](#).
8. Fume hoods shall comply with modified ASHRAE 110 testing requirements.



#### 4.6.1.11 Biological Safety Cabinets

Placing biological safety cabinets (BSCs) in laboratories shall comply with [Appendix A: Biological Safety Cabinet \(BSC\) Placement Requirements for New Buildings and Renovations](#).

**A. Selection and Placement:** The A/E and user shall consult with the DOHS during planning for assistance regarding selection and placement of BSCs. The DOHS must approve the placement and selection of all BSCs. In addition, the DOHS must certify all BSCs prior to use.

1. See [Appendix A](#) for detailed requirements.
2. BSCs shall be placed out of the direct traffic pattern of the laboratory.
3. Air supply diffusers or exhaust vents shall not be placed directly over or in front of BSCs.
4. 152 mm (6 in.) clearance is required between the rear of the BSC and the adjacent partition (or another cabinet).
5. Accommodate filter testing, maintenance, and access. Provide 356–457 mm (1 ft. 2 in.–1 ft. 6 in.) clearance on top of a BSC. Confirm operational and maintenance requirements with BSC manufacturer.
6. Pressurized gases, including natural gas, shall not be piped into BSCs. The use of compressed gases (such as lab air) has been shown to disturb intended airflow patterns within BSCs. Fuel gas has also proven hazardous and therefore should not be piped into BSCs.
7. Ceiling light locations shall be coordinated with BSC location to avoid light placement directly over BSCs that result in shadows.
8. Ceiling height to be coordinated with cabinet requirements to ensure proper airflow and containment within the cabinet.
9. Ducted BSCs shall be coordinated with the mechanical design to ensure appropriate air is provided. In addition, they must have a damper to allow the exhaust duct to be completely shut down for gaseous decontamination.

#### 4.6.1.12 Autoclaves

An autoclave shall be provided on each floor where microbiological research is performed. In large facilities, multiple units should be considered based on demand and maximum travel distance.

**A. Location:** Sufficient space and lighting shall be provided in the autoclave room to ensure easy access to the serviceable areas of the autoclave. The A/E shall review user requirements when designing and specifying an autoclave room.

**B. Finish and Lighting:** Autoclave rooms shall have moisture-resistant finishes and adequate lighting for maintenance activities.

**C. Exhaust:** The room shall have adequate exhaust capacity to remove heat, steam, and odors generated by the use of the autoclave(s). Steam capture shall be provided over each autoclave door where steam is used or sterilized material is removed.

**D. Pressure:** The autoclave space shall operate at negative pressure to the surrounding areas. See [Chapter 6: Mechanical Design](#).

**E. Seal:** Containment facilities may require a pass through autoclave with a bioseal to isolate the loading from the unloading end of the sterilizer. A risk assessment should be done with DOHS to evaluate the appropriate choice.

**F. BSL-3:** Refer to Sections [2.5](#), [2.6](#) and [4.9](#) for BSL-3 facility requirements.

#### 4.6.1.13 Ice Machines & Dry Ice Bins

An ice machine shall be provided on each floor of a lab building. The requirements of the floor occupants must be assessed to determine required ice production per day, as well as the size of the storage bin. The water connection should be filtered and the drain should be accessible for maintenance. Ice machines should not be located along primary circulation aisles where wet floors from spilled ice could create a slip hazard.

Consideration should be given to the quantity and placement of dry ice bins. The programmatic needs of the research will determine the quantity and size of dry ice bins needed. Bins should be located close to both vertical circulation as well as primary circulation corridors in the facility.

#### 4.6.1.14 Special Equipment

Labs containing specialized, sensitive equipment may have unusual utility, environmental, and other requirements.

**A. Utility Requirements:** Utility requirements may include, but not limited to, clean power, chilled water, electrical grounding, shielding, inert gases, and flammable gases.

**B. Environmental Requirements:** Environmental requirements may include temperature and humidity control, acoustical, vibration, lighting, and RF sensitivity.

**C. Manufacturer's Requirements:** During the design development phase, all of the equipment manufacturer's requirements and recommendations must be documented and assessed relative to the capabilities and limitations of the building. The equipment manufacturer should be engaged from an early point, and remain fully engaged through the construction document, construction, equipment delivery, installation, and startup phases, to ensure that all aspects of their requirements are met.

**D. Consultants:** Specialized consultants should be utilized for the planning and installation of new or unique medical and scientific technology, such as linear accelerators and positron emission tomography. Consultants may include, but are not limited to, acoustical and vibration engineers and shielding consultants.

#### 4.6.1.15 Lab Movable Equipment

##### 4.6.1.15.1 Flammable Storage Refrigerators/Freezers

Flammable storage cabinets and refrigerators/freezers shall be UL rated flammable storage and are required if flammable materials will be stored.

**A. Labeling:** Flammable storage refrigerators/freezers shall be clearly labeled. A label stating "Flammable Materials Refrigerator: Keep Fire Away" should be in place to identify such refrigerators.

**B. Storage:** Flammable materials may only be stored in approved UL labeled devices.

**C. Location:** Flammable storage refrigerators/freezers shall not be located in a room with explosive vapors.

**D. Design:** Flammable storage refrigerators may incorporate design features such as thresholds, self-closing doors, magnetic door gaskets, and special inner-shell materials that control or limit the damage if a reaction occurred within the storage compartment.

##### 4.6.1.15.2 Explosion Proof Refrigerators/Freezers

Explosion-proof refrigerators/freezers shall be UL rated explosion-proof and are required if volatile materials will be stored and the refrigerator/freezer is located in an area with explosive atmospheres, i.e., solvent dispensing room.

## 4.6.2 ARF Equipment and Furnishings

The following requirements for ARF equipment are in addition to the minimum requirements indicated above.

### 4.6.2.1 ARF Fixed Equipment

**A. Cage Wash Equipment:** Cage wash and sanitation equipment specifications are highly detailed and specific. All equipment selection and options must be reviewed with the facility managers and staff veterinarians during design development to ensure the final equipment is appropriate for the facility. Safety equipment shall be located where chemicals and detergents are used or connected.

The facility, including utilities and services, must be designed to accommodate the manufacturer's equipment requirements, including floor depressions, drains, clearances, and maintenance access, lighting, power, and exhaust.

The clean and dirty sides of the animal cage wash facility shall be separated by a full-height barrier wall to maintain pressure and cleanliness. During the construction phase, the designer and facility manager should review the shop drawings and product options again to ensure design intent is maintained if alternate manufacturer is procured. See Sections 2.3 and 2.4 for additional information on ARF Design.

**B. Fume Hoods and or Biological Safety Cabinets:** The determination to include a fume hood and/or BSC

within the boundary of the ARF shall be made with the representative user of the facility and in consultation with the DOHS personnel.

BSCs may be used in some animal holding rooms in lieu of a laminar flow changing station and procedure/treatment rooms. A risk assessment must be done with the DOHS, facility managers, and users to determine the appropriate location and piece of equipment.

**C. Downdraft Tables:** Downdraft tables may be required in labs that conduct animal procedures to draw fumes or particulate away from the table surface and user. Coordination is required with ventilation and plumbing requirements. Downdraft table options should be reviewed with the user during design to ensure the table accommodates the procedures planned. Downdraft tables shall have a dedicated airflow control device separate from the room general exhaust air valve so each can be properly adjusted independently. For additional information, see [Appendix B: Downdraft Table Particle Capture Efficiency Calculation](#).

#### 4.6.2.2 ARF Movable Equipment and Furnishings

ARF equipment and furnishings shall have surfaces that are easy to clean and decontaminate. Cloth or porous surfaces are not permitted. Furnishings shall be specified to prevent the harboring of pests.

**A. Lockers:** All lockers shall have sloped tops and solid-filled bases, unless they are recessed. At least one locker in each section shall meet all the reach requirements of the Architectural Barriers Act Accessibility Standard (ABAAS).

**B. Benches:** Benches shall be provided in all animal facility locker rooms. Benches can be fixed, folding or movable, depending on the condition of the space.

**C. Gowning Supply Storage:** Shelving shall be provided to accommodate gowning supplies in personnel entry areas. Supply shelving and disposal bins should not prevent the clear path of travel to and from the ARF. Determination of the quantity and type of storage shall be established during the concept design phase and shall be updated at each project phase.

# Section 4.7

## Vertical Transportation

---

### Contents

#### 4.7.0 Introduction

#### 4.7.1 General Requirements

##### 4.7.1.1 Elevator Classifications

##### 4.7.1.2 Finishes

##### 4.7.1.3 Vertical Transportation/Elevator Traffic Analysis

##### 4.7.1.4 Elevator Speed and Type

##### 4.7.1.5 Elevator Lobbies and Groupings

##### 4.7.1.6 Elevator Functional Separation

##### 4.7.1.7 Maximum Traffic Peak

##### 4.7.1.8 Limited-Rise Elevators

##### 4.7.1.9 Elevator Capacity and Platform Design

##### 4.7.1.10 Elevator Cars

##### 4.7.1.11 Entrances

##### 4.7.1.12 Signals

##### 4.7.1.13 Seismic Design

##### 4.7.1.14 Emergency Power Supply

##### 4.7.1.15 Door Operation

##### 4.7.1.16 Elevator Car Lighting and Exhaust

##### 4.7.1.17 Hoist Machine

##### 4.7.1.18 Elevator Machine Rooms

##### 4.7.1.19 Elevator Machine Room Temperature Control

##### 4.7.1.20 Access

##### 4.7.1.21 Electronic, Vibration, and Sound Isolation

##### 4.7.1.22 Lighting

##### 4.7.1.23 Access Doors

##### 4.7.1.24 Elevator Pits

##### 4.7.1.25 Elevator Fire Protection

##### 4.7.1.26 Emergency Operation

##### 4.7.1.26.1 Phase I Emergency Recall Operation

##### 4.7.1.26.2 Phase II Emergency In-Car Operation

##### 4.7.1.27 Elevator Controls

##### 4.7.1.28 Fixtures

##### 4.7.1.29 Door Operators

#### 4.7.2 Escalators

#### 4.7.3 Wheelchair Lifts

## 4.7.0 Introduction

This section describes the required features and elements of elevators and other means of vertical transportation within the NIH facilities.

### 4.7.1 General Requirements

All new and altered elevators and escalators must comply with ASME A17.1, Safety Code for Elevators. All new and altered lifts must comply with ASME A18.1, Safety Standard for Platform Lifts and Stairway Chair Lifts.

Selection of type and quantity of conveying systems, such as elevators, escalators, and wheelchair lifts, must be made in conjunction with a thorough vertical transportation traffic analysis of the facility.

**A. Visibility:** Elevators shall be visible from security screening areas within the main lobby to enhance supervision and control. Elevator lobby areas are considered to be an extension of the main lobby and shall receive similar design features.

**B. Location:** The location of elevators shall be such that they are easily accessible and convenient to circulation routes. When additional elevator banks are provided, every effort shall be made to locate them along the same major circulation paths that serve the existing elevators. Ample area for circulation and waiting of staff, visitors, and equipment shall be provided.

**C. Service Elevator:** If no separate freight or service elevator is provided, one passenger elevator must be designated as a service elevator with pads to protect the interior wall surfaces of the car. The passenger elevator designated as a service elevator must not be considered as one of the elevators required by the traffic analysis.

In large or high-rise buildings, the number of freight elevators provided should be determined by the elevator traffic analysis. The use of more than one freight elevator will provide better freight service for the tenants as well as provide redundancy for normal maintenance and times when repair work is conducted.

**D. Maintenance Floors:** Where equipment penthouses are provided, service elevators or freight elevators must provide access to that level. An elevator must service all maintenance floors.

**E. Trap Doors/Hoist Beams:** Trap doors and hoist beams must be provided at the elevator machine rooms for traction elevators where the machine room is not served by a freight or service elevator for removal of equipment for service and repair.

#### 4.7.1.1 Elevator Classifications

**A. Passenger:** Passenger elevators must be ABAAS compliant. Capacities of 1,588–1,814 kg (3,500–4,000 lb.) must be used for passenger elevators.

**B. Service:** A passenger elevator designed to meet the ASME A17.1 code requirements for “Carrying Freight on Passenger Elevators” is required. The minimum rated load must be based on the inside net platform area for passenger elevators, Section 8.2, Design Data and Formulas, ASME A17.1 – 2007. The car doors must be horizontal sliding type. The car platform must be designed to the applicable freight-class loading.

**C. Freight/Service:** A passenger elevator designed to meet the ASME A17.1 code requirements for “Carrying Freight on Passenger Elevators” qualifies for freight purposes.

**D. Security:** Security or specific-purpose elevators are custom designed to meet specific program requirements. Coordinate security requirements with DPSM.

**E. Shuttle:** A shuttle is typically a passenger elevator that services a limited number of landings, e.g., a parking garage to main lobby.

**F. Machine Roomless (MRL):** A machine-roomless elevator is an elevator with the drive machine, governor, and other related components located in the elevator hoistway. These elevators require specific NIH approval. The elevator must have a metal belt and the control system must be located outside of public areas to facilitate safe maintenance procedures. The MRL must meet the following minimum requirements:

1. Controls must be installed in a fire-rated control room.
2. The remote control room must be no more than 3 m (10 ft.) from the hoistway.
3. No other equipment is allowed in the control room (only equipment directly related to the elevator).

4. Main line disconnect switches must be installed within 457 mm (1 ft. 6 in.) of the strike jamb of control room door.
5. The car position, movement, and direction must be able to be determined from the control room.
6. Provide HVAC in the control room so that the temperature does not go below prescribed limits, as set by applicable codes and the requirements of the equipment manufacturer.
7. Access to the governor must be provided from outside the hoistway.
8. The suspension means must be manufactured for elevator use only and be constructed from steel only.

#### 4.7.1.2 Finishes

**A. Floor:** High quality resilient flooring or low-pile, high-density carpeting may be used on floors. Grouted materials should not be used unless the car subfloor is reinforced, as they are susceptible to degradation due to instability.

**B. Walls:** Wall materials shall be durable to resist abuse from impact damage and vandalism. Wall panels shall be removable for repair or replacement. Wall protection rails should be considered.

**C. Ceilings:** Ceilings shall be removable with recessed down lighting or indirect fixtures.

**D.** All finishes in elevators intended for animal use shall be appropriate for ARF facilities.

#### 4.7.1.3 Vertical Transportation/Elevator Traffic Analysis

**A. Criteria:** The elevator traffic analysis must be performed by an independent consultant to determine the type, quantity, capacity, and speed requirements of elevators. Separate calculations must be performed for each elevator classification. The criteria by which the traffic analysis calculations should be judged are average interval and handling capacity.

**B. Special Conditions:** Special conditions that must receive consideration in estimating elevator usage include

visitor traffic, building management and grouping of elevators. Other special conditions include restrictions and limitations, such as ‘patients only’ or ‘no animals’. Special functions which may require dedicated elevators or special demands on usage and function include ARF (including transportation of animals to and from loading docks), central sterile, surgery, warehousing and pharmacy.

**C. Average Interval:** Average interval is defined as the calculated time between departures of elevators from the main lobby during the morning up-peak period. Calculated intervals during the up-peak period should not exceed thirty seconds for a typical elevator bank.

**D. Handling Capacity:** Handling capacity is defined as the number of persons the elevator system must move in any given five minute period of up-peak traffic used to measure average interval. Buildings must be designed for a 12% handling capacity.

**E. Elevator Car Size:** Elevator car sizes must be in accordance with the standards established by the National Elevator Industries, Inc. Elevator cars must be designed to reflect the architectural character of the building design.

**F. Ceiling Height:** A minimum ceiling height of 2.7 m (9 ft.) is required in service elevator cars. Freight elevators must have a ceiling height of not less than 3.7 m (12 ft.). Large equipment needed for the building and construction materials for future renovations must be considered when sizing the elevator.

**G. Service:** Elevators shall be located so that they shall serve all floors that require service. This includes the basement, subbasement, and mechanical floors as well as all of the occupied floors of the facility. In facilities that utilize interstitial floors and mechanical penthouses, at least one elevator shall stop on these floors to facilitate equipment maintenance and removal. Elevators shall not be placed over occupied spaces as this shall require counterweight safeties and reinforced pits.

**H. Response Time:** Elevators shall be selected and located to permit transportation of 10% of the anticipated visitor and staff load within a five minute, two-way peak period. The number of elevators required shall be selected based on a thirty-five second response-waiting-time interval between elevators.



**I. Required Elevators:** If one elevator would normally meet the requirements in the facility where elevator service is essential (such as facilities over two stories high), two elevators shall be installed to ensure continuity of service. If financial limitations restrict the inclusion of a second elevator, as a minimum, a hoistway for a future elevator shall be provided.

**J. Codes:** The A/E shall utilize the latest editions of reference design and safety guidelines available at the time of the design contract award. ASME/ANSI A17 shall take precedence over all other codes. This includes designing to the appropriate rating/load classification for the intended application.

#### 4.7.1.4 Elevator Speed and Type

The parameters for the selection of elevator speed and type are provided in Table 4.7.1.4. Electric traction elevators are preferred for passenger and service applications. Hydraulic-powered elevators may be considered for use where vertical travel is less than 14 m (46 ft.) or where overhead clearance is limited.

#### 4.7.1.5 Elevator Lobbies and Groupings

**A. Pedestrian Traffic:** Like entrance lobbies, elevator and escalator lobbies must be designed to efficiently accommodate the movement of pedestrian traffic to other parts of the building. Provide adequate space for this movement. The elevator and escalator lobbies should be close to the main lobby and be visible from the main entrance. Visual supervision and physical control of the lobbies for elevators and escalators must be

a prime consideration for building security. Coordinate security requirements with DPSM.

**B. Equipment/Furniture Transport:** If unusually large pieces of equipment or furniture such as mechanical equipment or conference tables must be transported to a specific floor via an elevator, verify that the item can be moved into and through the lobby space.

**C. Elevator Banks:** Elevators shall be grouped in banks of adjacent cars or banks of cars facing each other. Where four or more cars are required within a group, cars shall be placed in opposite banks, opening to a common lobby. See Figure 4.7.1.5. For service and combined use cars, two across are preferred, and not more than three in a row shall be used. For passenger cars, a maximum of three across are preferred.

Figure 4.7.1.5 Elevator Lobby



Table 4.7.1.4 Elevator Speed and Type

Elevator Rise		Speed by Elevator Type		
Stops	Height	Hydraulic	Gearless	Gearless
2	< 4.6 m (< 15 ft.)	.635 m/s (2 ft./s)	N/A	N/A
3	4.6–13.7 m (15–45 ft.)	.635 m/s (2 ft./s)	N/A	N/A
4–7	>13.7–< 27.4 m (>45–< 90 ft.)	N/A	1.015–1.780 m/s (3.33–5.84 ft./s)	2.54 m/s (8.33 ft./s)
7–17	27.4–54.9 m (90–180 ft.)	N/A	1.780 m/s (5.84 ft./s)	2.54–3.56 m/s (8.33–11.7 ft./s)
> 17	> 54.9 m (> 180 ft.)	N/A	*	*

\*Consider separate high-rise and low-rise groups of passenger cars. N/A = not applicable.

**D. Corridor Access:** Elevator ingress/egress shall be from a distinct elevator lobby and not directly from a corridor. Refer to [Table 4.7.1.5](#) for lobby width requirements. Elevator lobbies generate noise and shall be acoustically isolated from areas sensitive to noise and vibration. Egress stairs shall be located adjacent to elevator lobbies when possible.

**E. Walking Distance:** Consideration shall be given to the maximum walking distance from the vertical transportation service to the most distant function. This factor shall be weighed along with the advantages of locating elevators near the center of the building and elevator clustering.

Refer to [Table 4.7.1.5](#) for walking distances. Any decentralized banks and/or clustering of elevators shall be planned to include at least two cars to maintain an acceptable dispatch interval between cars and to ensure continuity of service.

#### 4.7.1.6 Elevator Functional Separation

Traffic patterns shall be established to separate the various traffic types in an efficient, logical, safe, and secure manner, while maintaining levels of aseptic control consistent with the requirements of the facility. A positive separation of passenger and service elevators shall be provided. Separate “clean” and “dirty” material elevator facilities shall be provided where required.

#### 4.7.1.7 Maximum Traffic Peak

**A. Maximum Demand:** The A/E shall design to the maximum percentage of the total population on the floors served by the elevators that must be handled during any five minute period. This maximum traffic peak will vary with the type of functional areas and special conditions applicable to the facility. The computations for vertical transportation equipment shall be based on transporting 12% of those persons who move between floors during periods of maximum demand in five minutes. The peak values, together with the population density factor, shall provide a reserve capacity adequate to maintain satisfactory service during periods when one elevator is shut down for repairs.

**B. Two or More Locations:** Where groups of elevators serving identical floors are required to be furnished in two or more locations for the purpose of providing convenience of use, a minimum carrying capacity of not less than 120% of the maximum traffic peak shall be used.

**C. Capacity and Speed:** Passenger and service elevators shall have the capability to handle their maximum peak loads while providing a satisfactory interval. Capacity and speed shall be selected that shall require the fewest elevators to handle the peak loads with an acceptable interval. Refer to [Table 4.7.1.5](#) for maximum peak intervals.

**Table 4.7.1.5 Elevator Design Factors**

Elevator Design Factor	Passenger	Service/ARF
Lobby Width Amid Banks	3,600 mm–4,200 mm (11 ft. 10 in.–13 ft. 9 in.)	4,200 mm–4,800 mm (13 ft. 9 in.–15 ft. 9 in.)
Max Walking Distance	≤ 61 m (≤ 200 ft.)	≤ 61 m (≤ 200 ft.)
Optimal Walking Distance	≤ 46 m (≤ 150 ft.)	≤ 52 m (≤ 170 ft.)
Max Peak Value Interval	≤ 45 seconds	≤ 60 seconds
Elevator Weight Capacity	1,800 kg (4,000 lb.)	1,800 kg–2,300 kg (4,000 lbs.–5,070 lb.)
Elevator Platform Width	2,400 mm (7 ft. 10 in.)	1,100 mm–2,000 mm (3 ft. 7 in.–6 ft. 6 in.)
Elevator Platform Depth	1,900 mm (6 ft. 3 in.)	2,600 mm (8 ft. 6 in.)
Elevator Door Width	1,200 mm (4 ft.)	1,200 mm–1,500 mm (4 ft.–4 ft. 11 in.)
Entranceway Material	Varies	Stainless Steel
Elevator Car Enclosure	Varies	Stainless Steel

### 4.7.1.8 Limited-Rise Elevators

**A. Equipment:** Oil hydraulic and direct plunger elevator equipment shall be considered for limited rise (approximately 14 m [46 ft.] rise) and low-speed elevators. The elevator machine room (EMR) and pump unit shall be located adjacent to the hoistway at the lowest landing. All hydraulic elevators shall have an NIH compatible starter for the pump motor. All hydraulic elevators shall be equipped with a scavenger pump to retrieve the waste oil.

**B. Drive Controls:** The use of generator field or silicone controlled rectifier (SCR) drive controls is appropriate for unlimited applications.

**C. Traction Configuration:** A single-wrap, geared-traction configuration shall be used for up to 1.8 m/s (6 ft./s). A double-wrap or single-wrap, gearless-traction configuration shall be used with speeds of 2.0 m/s (6.5 ft./s) and greater. Roping shall be 1:1. Secondary sheaves shall be used with a secondary sheave area. All hydraulic elevators shall be equipped with emergency power outage car return controls.

### 4.7.1.9 Elevator Capacity and Platform Design

Platform size is to be evaluated relative to the type of travel and equipment requirements. Refer to [Table 4.7.1.5](#) for capacity and platform sizes.

### 4.7.1.10 Elevator Cars

Car enclosures shall have no front and rear entrance or corner post, shall be of a single-entrance type, and shall be of manufacturer's standard design unless modifications are dictated because of special project conditions. Car design shall be detailed on the project drawings. Refer to [Table 4.7.1.5](#) for materials.

### 4.7.1.11 Entrances

Passenger and service elevators shall have single speed, bi-parting horizontal, center-opening doors, with infra-red screen detectors. Door-closing time must comply with ASME requirements. All elevators shall be equipped with buttons to extend door-opening time, adjustable between 0–30 seconds. The elevator car doors shall be provided with door widths and entranceway materials

per [Table 4.7.1.5](#). Tamper proof screws shall be used for all car and corridor fixture plates. Thresholds outside of elevators shall be durable and non-slip.

### 4.7.1.12 Signals

Hall pushbutton stations shall be provided with call-register LED lights and shall be compatible with existing systems and components. Hall lanterns with an audible signal shall be installed on all elevators. Hall-position indicators shall be designed to be visible from each side. Hall-position indicators shall be compatible with existing systems and components designed on the control board for compatibility with the existing controllers. Car-position indicators shall be installed in each car with floor designations, a floor-directory signal, and direction arrows. Car-operating panels shall use car register floor buttons engraved with building and elevator number. Car-operating panels shall be compatible with existing systems and components series. A lobby control panel shall be provided on elevator banks with two or more cars. Signal fixtures and gongs shall conform to the requirements of ASME/ANSI A17.1 and ABAAS.

### 4.7.1.13 Seismic Design

Seismic protection shall be provided as required.

### 4.7.1.14 Emergency Power Supply

An emergency power supply shall be provided per ASME/ANSI A17.1 and tailored to the needs of the building. The equipment specified depends on the service demand and the equipment commercially available to meet that demand. Care shall be exercised to avoid specifying non-competitive methods in features of elevator dispatching and control operation.

### 4.7.1.15 Door Operation

Power door operation shall be provided for all elevators. The door opening shall be capable of opening doors at the rate of 0.9 m/s (3 ft/s). This is a capability speed, with actual speed being adjusted to meet the requirements of the specific installation. The closing speed shall be set per ASME/ANSI A17.1. All power operated doors shall be equipped with an automatic reopen device for passenger protection.

#### 4.7.1.16 Elevator Car Lighting and Exhaust

Car lighting shall be either indirect or of the luminous ceiling type. Mechanical exhaust shall be provided.

#### 4.7.1.17 Hoist Machine

Geared and gearless hoisting machines shall be located directly above the hoist way in an EMR where practical by design. For speeds up to 0.5 m/s (1.6 ft./s), alternating current, a two-speed control system with a low-speed range from 0.15–0.2 m/s (0.5–0.7 ft./s) shall be provided. For car speeds of 0.8 m/s (2.6 ft./s) and greater, a generator field control system shall be provided. The hoisting machine and its control system shall be capable of stopping the car at floor level within plus or minus 5 mm (1/5 in.) of hoist way doorsills. It shall also be capable of correcting for car over travel, under travel, and rope stretch. Car stopping shall be automatic and independent of operating devices. Hoistways shall be illuminated per ASME/ANSI A17.1.

#### 4.7.1.18 Elevator Machine Rooms

EMRs shall be large enough to install the elevator equipment, including space for controllers, safe clearances, equipment maintenance, and ventilation, and with minimum headroom of 2.3 m (7 ft. 6 in.). Sight lines for technicians shall be provided. Control equipment shall be provided with clearances per code to provide access for maintenance. EMR design shall accommodate removal of major equipment components of each elevator for repair without dismantling the components of adjacent elevator(s).

#### 4.7.1.19 Elevator Machine Room Temperature Control

**A. Air Conditioning:** Air conditioning shall be provided in EMRs to maintain ambient temperatures within the range prescribed by applicable codes, and as required by equipment manufacturers. Provide adequate exhaust. Filters shall be provided to remove dust, and are heated and ventilated to acceptable levels. Reasonable conditions must be maintained in these rooms for worker comfort, to increase equipment life, and to avoid excessive heat gains and losses to adjacent occupied areas.

EMRs with electronic equipment may require air conditioning instead of ambient ventilation. The project engineer shall define criteria for these spaces and design

accordingly. Often these rooms require air conditioning when building systems are off, thereby justifying the use of packaged spot coolers or fan coil units.

**B. Heating:** Heating for equipment spaces generally consists of steam or hot water unit heaters sized to heat the space as required to maintain ambient temperatures within the range prescribed by applicable codes, and as required by equipment manufacturers. Heaters shall be strategically located so they can offset infiltration loads caused by leakage through louvers, etc., and to ensure that pipes within EMRs do not freeze during severe weather conditions.

**C. Ventilation:** EMRs shall be ventilated, at a minimum, to code requirements for maintaining acceptable internal air quality and internal heat gains that drive ventilation air quantities far above code minimums. The project engineer shall itemize operating equipment and establish estimated heat gains for each space. The ventilation systems shall be sized to maintain ambient temperatures and air quality within the range prescribed by applicable codes, and as required by equipment manufacturers.

Ventilating elevator shafts and EMRs shall comply with code. It is desirable to filter makeup air for ventilation of all EMRs, but this becomes impractical because of large air quantities in many cases. The ASME/ANSI 17.1 strictly prohibits the installation of any building systems in those rooms unless they serve the space. When locating heating equipment and routing piping within these areas, care shall be taken to minimize the length of run and not to traverse electrical equipment.

#### 4.7.1.20 Access

EMR access shall conform to ASME/ANSI A17.1. Stairs shall be provided for convenient access to EMRs. Access to EMRs shall preferably not require passage across a roof or similar exposed area.

#### 4.7.1.21 Electronic, Vibration, and Sound Isolation

**A. Isolation:** All EMRs shall be electronically and acoustically isolated to prevent interference from building electronic equipment and objectionable noises. EMRs shall be acoustically separated from all critical care areas, occupied rooms and animal holding rooms or where sensitive equipment is used.

**B. Isolating Devices:** Geared and gearless machines and motor generator sets shall be mounted on vibration-isolating and sound-isolating devices. These isolating devices, when required, shall conform with seismic design requirements.

**C. Trapdoors and Hoisting Beams:** Trapdoors and hoisting beams shall be installed in all EMRs to facilitate maintenance and removal of equipment for repairs.

#### 4.7.1.22 Lighting

Adequate lighting shall be provided to ensure proper illumination in the front and rear of all controllers, on supervisory and selector panels, and over each hoisting machine. Convenience outlets shall be provided for each elevator area within the EMRs.

#### 4.7.1.23 Access Doors

Access doors and frames to secondary levels shall be “B” label and a minimum of 762 mm (2 ft. 6 in.) wide by 1.1 m (3 ft. 7 in.) high. Each door shall be of the self-closing, self-locking type and shall have a cylinder lock that requires a key for entry only. Stairway and ladders to access doors shall be installed in compliance with ASME/ANSI A17.1.

#### 4.7.1.24 Elevator Pits

Elevator pit and drainage shall be provided, including sump pumps, drains, and gratings in locations and sizes per elevator code. Drainage from sump pumps shall be connected to the nearest acceptable sanitary line/location in accordance with requirements of the elevator code and Chapter 8.

#### 4.7.1.25 Elevator Fire Protection

All elevator fire protection systems shall be installed in accordance with applicable NFPA codes and standards and ANSI A17.1.

#### 4.7.1.26 Emergency Operation

Phase I emergency recall operation and phase II emergency in-car operation key switches (which come with the installation of the elevators) for use during

construction shall be provided. After complete installation and before final acceptance by the NIH, the contractor shall replace the aforementioned switches by installing NIH-furnished phase I emergency recall operation and phase II emergency in-car operation key switches. These NIH-furnished switches shall be tested by the NIH during the final inspection and acceptance testing of the elevators.

##### 4.7.1.26.1 Phase I Emergency Recall Operation

A three-position (Off, On, and Bypass) key-operated switch for phase I emergency recall operation shall be provided at only the primary designated level and alternate level for each single elevator or group of elevators. The key shall be removable in the Off and On positions only. The switch shall normally be in the Off position. Operation of the three positions shall be as follows:

**A. Off Position:** Restores normal elevator service to the elevator or group of elevators served by the switch

**B. On Position:** Recalls the elevator or group of elevators served by the switch to the designated or alternate level

**C. Bypass Position:** Restores normal elevator service to all elevators served by the switch, regardless of elevator smoke detector(s) status

##### 4.7.1.26.2 Phase II Emergency In-Car Operation

A three-position (Off, On, and Hold) key-operated switch for phase II emergency recall operation shall be provided in all elevator cars. The key shall be removable in the Off, On, and Hold positions. The switch shall normally be in the Off position. Operation of the three positions shall be as follows:

**A. Off Position:** Automatically causes the elevator to return to the “designated level” for use by later arriving firefighters

**B. On Position:** Permits the firefighter to take control of the elevator, overriding automatic operations

**C. Hold Position:** Allows the firefighters to remove the key and leave the car without danger of the car being taken to another floor



### 4.7.1.27 Elevator Controls

**A. Controller:** All new elevator installations and upgrades to existing elevators shall be equipped with a solid-state microprocessor-based controller compatible with existing NIH campus-wide controller systems. Hydraulic controllers are recommended for hydraulic elevator applications. For all locations, coordinate with the campus-wide controller system.

**B. DC-SCR Drives:** All new elevator installations and upgrades to existing elevators shall be equipped with a DC silicone controlled rectifier (SCR) drive in lieu of motor generator sets. Provide the latest version SCR drive for elevator hoist motors that is compatible with the existing NIH campus elevator components and systems.

### 4.7.1.28 Fixtures

**A. Identification/Compatibility:** All new elevator fixtures shall be engraved with building number and elevator number and include LED illumination; the hall stations shall be engraved with the fire station information. All fixtures shall be compatible with the existing NIH campus elevator components and systems.

**B. Operating Panels:** Car-operating panels shall be compatible with the existing NIH campus elevator components and systems, equipped with emergency lighting, digital position indicator, and built-in autodialer telephone with call-tracking capability and firefighter return service controls and signals. An integral floor announcer shall be provided to announce floor stops; car direction, nudging, and firefighter's return service. Floor buttons shall be rectangular in shape with numerals and LED illumination. Car station shall be provided with a 120 V ground fault circuit interrupter receptacle and include the following key switch arrangements:

1. Inspection key switch duo
2. Car lighting key switch duo
3. Fan key switch duo
4. Independent service key switch duo
5. Hall access key switch duo
6. Other features as required by AHJ

### 4.7.1.29 Door Operators

All new elevators shall be equipped with door operators for standard and bi-parting freight doors; and all freight elevators shall be equipped with door operators for horizontal doors, compatible with the existing NIH campus elevator components and systems.

## 4.7.2 Escalators

Due to their high operation and maintenance costs, use escalators only where necessary. The A/E must submit a request through the PO to incorporate an escalator in the project. Incorporating an escalator in the design must be justified by the vertical transportation analysis. Escalators may be installed as supplements to elevators when vertical transportation is required for a large unpredictable volume of public traffic. They should be used where the first floor is not large enough to contain the high public traffic so that the interval for elevators can be calculated with accuracy.

Escalators should be located to be visible from the building entry and convenient to the areas they serve.

## 4.7.3 Wheelchair Lifts

Wheelchair lifts must comply with the current edition of ASME 18.1 Safety Standard for Platform Lifts and Stairway Chairlifts. Proper design of accessible routes in new construction should not require the use of wheelchair lifts. In repair and alteration projects, ramps are preferred to wheelchair lifts.



# Section 4.8

## Loading Docks

---

### Contents

4.8.0 Introduction

4.8.1 General Requirements

4.8.1.1 Apron Areas

4.8.1.2 Dock Berths

4.8.1.3 Shipping and Receiving Areas

4.8.1.4 Materials and Finishes

4.8.2 Waste-Handling Areas

4.8.3 Animal Research Facility Loading Dock

## 4.8.0 Introduction

This section provides the requirements for loading docks at NIH buildings as well as special features required in loading docks that support research facilities. It is not intended as a comprehensive guide for loading dock design.

### 4.8.1 General Requirements

Loading dock requirements vary widely depending on facility size and use. Functions that place increased demand on the loading dock include health care, food service, and animal facilities. Consultation by a professional material handling consultant is recommended for waste and material handling.

**A. Needs Assessment:** Programming shall include an assessment of needs including material handling, waste disposal, recycling, hazardous materials handling, storage, loading dock management and oversight, security requirements, and special uses (e.g., dedicated areas for animal facilities, food service, etc.). Participants in this assessment shall include:

1. User group representatives
2. Dock Material Management Services
3. Division of Environmental Protection
4. Division of Occupational Health and Safety (including a representative from the Integrated Pest Management (IPM) branch)

**B. Staffing:** Larger facilities may have dedicated staff including a building manager, dock managers, and/or security staff that may require space at or adjacent to the loading dock.

**C. Functional Relationships:** Building loading docks shall be located so that they are separated from primary building entrances (including adjacent buildings). Access to loading docks should be provided from secondary or service roadways to the greatest extent possible.

**D. Access:** Loading docks shall have convenient access to receiving areas and freight elevators, and be segregated from personnel elevators, entry lobbies, and other public spaces. Corridors and doorways

connecting loading docks with freight elevators shall be configured to allow for transport of large equipment used in the facility.

**E. Waste Handling:** Loading dock areas used for personnel, shipping, and receiving shall be isolated from areas used for waste handling to the greatest extent possible. Waste materials shall not be staged within the receiving area.

Separate spaces shall be provided for holding and disposing of medical pathological waste (MPW), hazardous waste, radioactive waste, mixed waste, general waste, and recycling waste.

**F. Emergency Egress:** Emergency egress paths shall not pass through the loading dock, material staging, or vehicle berth areas.

**G. Animal Facility:** When the loading dock also services an animal facility, a separate, secure area shall be provided that is dedicated to the animal facility.

**H. Security:** Security requirements shall be determined by threat risk assessment. Security features may require separation of dock areas from critical utility rooms and fuel storage facilities, and blast hardening. Vehicular areas shall not be located under the building. Coordinate security requirements with DPSM.

**I. Loading dock apron areas** shall not be located near building air intakes.

#### 4.8.1.1 Apron Areas

Sufficient clearance shall be allowed in apron areas to accommodate service vehicles without blocking adjacent pedestrian walks or roadways. Dumpsters and trash compactors shall be arranged to facilitate proper use and cleaning, and avoid infringement onto service vehicle berths and maneuvering areas.

**A. Paving and Drainage Grates:** Apron area paving and drainage grates shall be structurally capable of supporting wheel loads for designated service vehicles.

**B. Loading Dock Berths:** A minimum of two loading dock berths per building shall be provided.

**C. Dumpster and Trash Compactors:** An apron area for a minimum of one dumpster and two trash compactors shall be provided.

**D. Compactors:** All new buildings shall be provided with a minimum of two 23 m<sup>3</sup> (30 yd<sup>3</sup>) self-enclosed compactors or equivalent equipment for collection of cardboard to be recycled and general trash. Additional area may be required for storage trailers.

**E. Concrete Apron and Access:** A 9.1 m (30 ft.) deep, 203 mm (8 in.) thick reinforced concrete apron shall be provided to accommodate waste dumpsters. Access for disposal of trash to the dumpster shall be directly from the loading dock.

**F. Electrical Power:** Electrical power shall be provided to compactors and dumpsters per manufacturer recommendations.

**G. Drainage:** An apron area shall be properly sloped to prevent storm water ponding, and designed to contain spills of hazardous substances and minimize the contamination of storm water runoff. Grate drains within vehicle loading areas shall be equipped with a normally closed valve. Uncontaminated storm water runoff shall be diverted to alternate grate drains or other outlets.

#### 4.8.1.2 Dock Berths

Dock elevations shall be sized to accommodate vehicles used to service the building, typically 1,067–1,397 mm (3 ft. 6 in.–4 ft. 7 in.) above service yard grade. Minimum berth width shall be 3.7 m (12 ft.); 4.3 m (14 ft.) should be considered if large vehicles regularly use the dock, and space permits. Minimum berth depth shall be 3 m (10 ft.) Greater depth may be required for material transport behind lifts depending on the mode of transport.

**A. Load Levelers:** Loading dock berths shall be equipped with load levelers; at least one should be equipped with a hydraulic scissors lift capable of carrying a 1,000 kg (2,205 lb.) load as a minimum. Levelers shall not extend under doorways, as they can become pathways for pest infestation.

**B. Overhang:** An overhang extending 1.2 m (4 ft.) beyond the edge of the platform shall be provided at open docks for weather protection. Overhangs and canopy projections must be of a sufficient height so as to provide necessary truck clearances, including the removal of refuse containers.

**C. Bird Exclusion:** Overhangs and associated spaces shall be designed such that nesting areas are not created for birds. If ledges are unavoidable, netting should be considered.

**D. Exposed Edges:** Protective steel guards shall be provided to protect exposed edges.

**E. Bumpers:** Commercial-grade shock-absorbing dock bumpers shall be mounted under load levelers. Barriers that prevent a truck from damaging the load leveler when backing to the leveler shall also be provided.

**F. Intercom or House Phone:** An intercom or house phone shall be provided to communicate with the dock manager or building occupants. Coordinate security requirements with DPSM.

**G. Hose bibs:** Hose bibs shall be provided for wash down and sanitation.

**H. Lighting:** Each berth shall be equipped with adequate lighting to illuminate the dock and service vehicle interiors.

**I. Service Ramp:** A service ramp and stairway shall be provided near the loading berths. Minimum ramp width 914 mm (3 ft.), maximum slope 1:6.

#### 4.8.1.3 Shipping and Receiving Areas

Receiving areas shall be provided directly adjacent to dock berths. An office with visibility to the loading dock berth area shall also be provided for the dock manager. A security station may also be required. A dedicated toilet room and vending area should be considered for dock staff and service-vehicle drivers, depending upon the size of the facility.

**A. Exterior Doors:** Exterior overhead coiling doors are recommended for provided access to loading dock berths. At least one exterior personnel door shall also be provided. All doors shall be weather tight and securable. Refer to [Section 4.2 Doors](#).

**B. Air Curtain:** An air curtain or similar device shall be provided at each material transport door for energy-efficiency and prevention of flying insects.

**C. Weather-resistant doors:** Weather-resistant doors should be considered for corridors accessing receiving areas to protect the building environment when the overhead doors are open.

#### 4.8.1.4 Materials and Finishes

Materials, finishes, fixtures, and construction detailing throughout the loading dock area shall be impact resistant, durable, and easily cleanable. CMU partition construction is preferred in all areas used for material transport or storage. Gypsum wallboard, if used, shall be high-abuse type with a glass-fiber reinforced finish. Wall protection rails and corner guards shall be provided for all partitions subject to impact, including exterior walls at open berth areas. High-performance coating system finishes capable of frequent sanitation and hose-down shall be used in receiving and waste-holding areas.

### 4.8.2 Waste-Handling Areas

Separate areas shall be provided within the dock area as determined by waste handling SOPs for holding and disposal of MPW, chemical waste, multihazardous waste, radioactive waste, trash, and recycling waste. Requirements for these areas are provided in [Section 1.11 Environmental Management and Radiation Safety](#).

### 4.8.3 Animal Research Facility Loading Dock

The need for a separate loading dock for the animal research facility shall be determined by the program based on required SOPs, security issues, facility size, etc. Loading docks dedicated to the animal research program are an extension of the animal facility, and shall comply with requirements listed in other sections of the *DRM* related to construction and sanitary detailing within the ARF. The ARF dock shall be segregated and secured from other areas of the loading dock, and provide an effective barrier between the outside and the clean environment of the animal care facility.

**A. Dock Berth and Receiving Areas:** A dedicated dock berth and receiving area shall be provided meeting all requirements listed above. Separate clean and soiled areas should be provided to facilitate SOPs requiring separation of incoming materials from outgoing waste.

An intercom or telephone shall be provided for communication between delivery and ARF personnel. The loading dock berth and receiving area should be designed to visually screen deliveries. A partially or fully enclosed berth for loading and unloading vehicles should be considered for programs utilizing large animals and species that are intolerant of temperature fluctuation.

**B. Material Transport:** A designated route of transportation between the ARF and designated loading dock shall be defined. Depending on SOPs and facility size, this may be programmed as a fully segregated route. A dedicated vestibule or area shall be provided for surface decontamination of incoming materials prior to entry into the ARF. The decontamination area shall be appropriately constructed with durable finishes resistant to decontaminating chemicals used. It may also require a drain and hand wash sink depending on SOPs. When programmed, decontamination SOPs may also require placement of an autoclave and/or misting tunnel adjacent to the ARF receiving area for decontamination of incoming materials.

**C. Storage Area:** Storage areas shall be provided for material dedicated to the ARF that may include gas cylinders, bulk decontaminants and cage wash detergents, packaging material, etc. See [Sections 2.3 and 2.4](#) for ARF design requirements.

**D. Holding Area:** A holding area for animal intake and acclimation shall be provided if required by the program.

**E. Cold Storage Room or Freezer Area:** A cold storage room or freezer area shall be provided within the soiled area for animal carcasses and other MPW marshaling unless this function is planned to be located directly within the ARF.

**F. Waste Containers:** Apron space shall be provided as necessary for waste containers dedicated to the ARF. This may include receptacles that are part of an automated animal bedding waste removal system that includes components such as air compressors, vacuum pumps, etc., that require dedicated utility rooms, power supply, and exhaust stacks.

**G. Loading Dock:** The ARF loading dock may include automated systems for bulk feed and/or bedding storage, as well as dedicated equipment to support automated transport of this material to the ARF.

# Section 4.9

## BSL-3 and ABSL-3 Biocontainment

---

### Contents

4.9.0 Introduction

4.9.1 Barriers

4.9.2 Exterior Envelope

4.9.2.1 Security

4.9.3 Doors

4.9.3.1 Exterior Doors

4.9.3.2 Interior Doors

4.9.4 Partitions

4.9.5 Interior Finishes

4.9.5.1 Floor Finishes

4.9.5.2 Wall Finishes

4.9.5.3 Ceiling Finishes

4.9.6 Penetrations and Sealants

4.9.7 Access Panels

4.9.8 Casework

4.9.9 Decontamination

4.9.10 Autoclaves

4.9.11 Equipment

4.9.12 Signage

4.9.13 Mock-ups

4.9.14 Commissioning

4.9.15 Certification

## 4.9.0 Introduction

Biocontainment refers to the safe management of infectious material. The purpose of containment is to reduce or eliminate potential exposure inside the laboratory and in the outside environment to potentially hazardous agents.

The BSL-3 and ABSL-3 classifications are categorized by the NIH/CDC *Biosafety Microbiological and Biomedical Laboratories (BMBL)* as work that involves infectious agents that may cause serious or potentially lethal disease as a result of exposure by inhalation route.

This section includes the requirements for BSL-3 laboratories and ABSL-3 facilities referred to collectively as *biocontainment facilities*.

### 4.9.1 Barriers

Barriers are fundamental to the safety and function of biocontainment facilities. Barriers are required to contain infectious agents and protect the people who are working directly with them. Barriers also protect occupants in the building outside of the lab and people and animals in the larger community. Barrier protection is accomplished as a two-layer approach, consisting of primary and secondary barriers. Refer to requirements of primary and secondary barriers in [Section 2.5 Biocontainment Facility Predesign](#).

### 4.9.2 Exterior Envelope

The exterior envelope shall comply with [Section 4.1 Exterior Envelope](#) in addition to the following. The exterior envelope must be sealed adequately to maintain the pressurization. Pressurization is fundamental for maintaining the desired directional airflow that controls and directs potentially contaminated air until it is exhausted from the building.

#### 4.9.2.1 Security

The exterior envelope must be resistant to intrusion and damage, and must protect occupants, research and critical assets. Specific envelope security requirements

shall be developed during project planning, in consultation with the Division of Physical Security Management (DPSM) and the Division of Police. Typical requirements include:

**A. Access:** A biocontainment laboratory shall not be accessed from the exterior, but through a lower-risk laboratory area (generally BSL-2), with locks, card readers and other appropriate security devices. A BSL-3 laboratory should have exterior doors only if required for emergency egress. Emergency egress doors shall be separated from the containment zone with a vestibule, shall be locked (with appropriate exiting devices), be alarmed and should not have exterior hardware. In most cases locks must fail secure. An exterior lock box for emergency responders may be required.

**B. Blast and/or Intrusion Resistance:** Windows and other exterior elements may have blast and/or intrusion resistance requirements, especially at the ground floor. Requirements shall be as prescribed by the threat risk assessment and the DPSM.

**C. Protection:** Air intakes, generators and other elements may have to be protected from damage and tampering.

### 4.9.3 Doors

#### 4.9.3.1 Exterior Doors

All exterior doors shall comply with [Section 4.2 Doors](#) in addition to the following: Exterior doors should be solid (no glass), with no exterior hardware. Doors shall be heavy duty and intrusion resistant. Doors shall be insulated and weather-stripped.

#### 4.9.3.2 Interior Doors

Doors in a biocontainment facility are a component of the secondary barrier. Doors and hardware must be self-closing. Entry doors and exit doors shall be arranged in a vestibule, with directional airflow and pressurization maintained by an interlock mechanism or entry/exit SOP. Door status shall be monitored by the BAS system. Doors shall be stainless steel, fiberglass-reinforced polymer (FRP), epoxy-painted welded steel or another durable material. Frames shall be fully welded, sized for



the passage of large equipment, and shall have stainless steel protection plates. Knock-down frames are not permitted. Vision panels shall be in all doors unless prohibited for programmatic reasons. Consideration should be given to power-activated doors where hands-free operation is needed or high-traffic is anticipated.

Doors serving vestibules, barrier partitions, and other locations that require directional airflow shall be configured to allow for sufficient air movement at the undercut to achieve proper operation without excessive pull or closure pressure. Door sweeps shall be adjustable to facilitate air movement. Automatic door closures and access control security plates must not produce excessive noise or pinch point for fingers.

Doors serving vestibules, anterooms, and other transitional spaces shall be equipped with access control. Visual indicators shall be provided adjacent to all vestibule doors to verify directional airflow. In suites with multiple laboratories or procedure areas, directional airflow indicators are recommended on the outside of each door.

If biometric access control is provided, the type of biometric reader shall be reviewed with security personnel and users to ensure proper selection and coordination with PPE worn at the location of the reader. Electronic access control into the containment zone shall “fail-safe” for egress purposes during power interruptions and “fail-secure” for reentry.

#### 4.9.4 Partitions

Partitions shall comply with [Section 4.3 Partitions](#) in addition to the following. Partitions in a biocontainment facility shall be selected to withstand pressurization, impacts and water or moisture. Partition material and detailing shall minimize differential movement. Interior partitions which are part of the secondary barrier shall extend to and be sealed to the underside of the structure. Additionally, partitions shall comply with all physical security requirements as dictated by a threat risk assessment.

Frame partition assemblies shall include gypsum board that is selected and detailed to be appropriately impact and moisture or water resistant. Standard gypsum board is not acceptable. Light-gauge steel studs used for partition framing shall be 18 gauge minimum thickness. Screw spacing in gypsum wallboard assemblies shall not exceed 152 mm (6 in.). Structural adequacy shall be verified, and additional lateral reinforcement provided if required. All partitions that do not extend to the underside of the structure shall be capped.

Concrete masonry units (CMU) walls shall include masonry units utilizing fine sand aggregate or ground face to provide an appropriate substrate for block filler and epoxy paint. Voids in CMU partitions shall be sealed above the ceiling.

#### 4.9.5 Interior Finishes

The interior finishes of a BSL-3 and ABSL-3 facilities shall form a durable, monolithic, impermeable enclosure. Mock-ups of all finishes shall be provided for review and approval, and as a basis for acceptance of the final installation. The mock-ups shall be constructed in the same conditions, and using the same materials and techniques as the final installation. The mock-ups shall include all typical conditions, including sealants, transitions between materials, inside and outside corners.

BSL-3 and ABSL-3 wall and ceiling finishes, unless factory finished, shall be high performance reinforced multi-coat resinous paint finish (reinforced epoxy paint or equivalent). Paint applicators shall be Society for Protective Coatings (SSPC) Coating Application Specialist (CAS Level II) Certified, and must be trained and approved by the paint manufacturer. All high performance resinous paint applications must be inspected by an independent third party Coating Inspector Program (CIP) level 3 certified inspector.

***Rationale:** The interior finishes of a biocontainment laboratory are a key containment element and must maintain performance while being subject to wear, moisture, harsh chemicals and other laboratory conditions.*

#### 4.9.5.1 Floor Finishes

Interior finishes shall comply with [Section 4.4 Interior Finishes](#) in addition to the following. Floors shall be durable, slip-resistant and resistant to degradation from chemicals, disinfectants, and decontaminants. Floors shall be monolithic with an integral coved base 152 mm (6 in.) minimum height, sealed to the wall finish. The flooring shall extend under all equipment and casework. Heat-welded sheet vinyl is most typically used in BSL-3 labs, and epoxy is standard in ABSL-3 facilities and BSL-3 labs where high durability or load capacity is required.

Floors of mechanical rooms and interstitial levels located above biocontainment areas shall be designed to prevent leaks. Penetrations through the floor shall be protected by raised curbs or sleeves.

Floors of mechanical rooms and interstitial levels located directly above biocontainment areas shall be marked to indicate the location of rooms and utility distribution below where possible.

#### 4.9.5.2 Wall Finishes

Walls shall be durable, monolithic and resistant to chemicals and disinfectants. Walls shall be sealed to the base, ceiling, door frames, cover plates and all other openings and penetrations. Epoxy paint or panelized composite systems are standard in BSL-3 and ABSL-3 facilities. Wall construction and materials must be selected to ensure compatibility with finish systems, and to provide a smooth, void-free substrate. Wall finishes shall be protected from impact and wear utilizing corner guards, crash rails, FRP panels or other methods in vulnerable areas. Refer to [Section 4.4.5](#).

#### 4.9.5.3 Ceiling Finishes

Ceilings shall be durable and resistant to moisture, wash-down and pressurization. Ceilings shall be monolithic, sealed to the walls and with sealed access panel, lights, diffusers and other ceiling-mounted devices. Epoxy painted gypsum board or panelized composite systems are standard in BSL-3 and ABSL-3 facilities. Gypsum board shall not be standard wall board, but must be specified and detailed to be appropriately moisture and sag resistant. Acoustical tile ceiling systems are not acceptable. Refer to [Section 4.4.5](#).

### 4.9.6 Penetrations and Sealants

All penetrations into and through partitions, floors, and ceilings shall be sealed to enhance sanitation, facilitate gas and vapor decontamination, and resist air infiltration. Piping, ductwork, electrical boxes, and other penetrating items shall be firmly anchored to resist movement that could damage seals. Penetrations shall be visible for inspection and maintenance.

Escutcheons shall be provided to reinforce the seal at piping penetrations through gypsum drywall and other rigid materials. Escutcheon rings shall be flat, without inaccessible voids and fully embedded in sealant.

Seams between walls, floors, and ceilings, and between all dissimilar materials shall be fully sealed. Sealant at movement joints shall be applied after installation of high-performance finishes to resist cracking.

Sealant shall be applied in a uniform, smooth, and continuous manner, resulting in a finish free of voids, pinholes, sharp edges, or excess sealant. Sealant must be compatible with all material that it is in contact with, including other sealant. Sealant must have chemical resistance, flexibility, durability, adherence, and other characteristics appropriate for its use. Opaque sealant shall be utilized to verify full coverage and highlight imperfections in application. Use of a qualified sealant contractor is recommended. Sealants shall comply with the [Appendix L: Sealant Table](#).

***Rationale:** Sealants are an integral component of the barrier assemblies. A sealant failure is a containment failure.*

### 4.9.7 Access Panels

All utility systems shall be configured to minimize the need for access panels within the containment barrier.

Access panel frames shall be sealed to the wall or ceiling, and fitted with a continuous, gastight door gasket. Panel design shall ensure compression of the gasket around the entire panel door perimeter without discontinuity at

the hinge or latch when in the latched position. Access door assemblies shall be stainless steel or another non-coated, corrosion-resistant material.

### 4.9.8 Casework

Casework shall comply with Section 4.5 in addition to the following. Movable tables, mobile base units and cantilevered bench tops shall be used whenever possible. Where fixed casework components must be used, they shall be set on monolithic bases to facilitate installation of integral cove flooring base. Void areas behind fixed casework shall be sealed to walls. All items shall have smooth corners and edges and be free of open joints and voids. All fixed items shall be sealed to the floor, wall and adjacent items. Welded stainless steel is standard in ABSL-3 facilities, and BSL-3 labs where moisture or frequent cleaning or disinfections is required.

*Rationale: Movable tables, mobile base units and cantilevered bench tops are easier to disinfect than standard fixed casework.*

**A. Shelving:** Shelving standards shall be open fronted or otherwise detailed to allow for full sanitation. Slotted standards with inaccessible concealed areas are not allowed.

**B. Cabinets:** Cabinets shall be designed without inaccessible areas that cannot be easily sanitized or disinfected. Joints, holes, and anchors shall be sealed.

**C. Utility Umbilicals:** Utility umbilicals serving islands and peninsulas shall either be fully sealed or designed to be easily opened and decontaminated. Utilities entering the umbilical should be sealed where they penetrate the ceiling or partition regardless of the umbilical design. Electrical raceways are not allowed.

**D. Task lighting:** Task lighting, if required, shall be a plug-in type to facilitate removal for decontamination.

**E. Bench Tops:** Bench tops shall be epoxy, stainless steel, or phenolic resin.

**F. Finishes:** Casework finishes shall be resistant to agents used for decontamination. Stainless steel, phenolic resin, or other corrosion-resistant materials shall be used in damp or corrosive environments.

**G. Sinks:** All laboratories require a hands-free or automated hand washing sink located near the exit door.

### 4.9.9 Decontamination

Surface wipe down with disinfectants is required in all BSL-3 and ABSL-3 settings. Other whole room or equipment decontamination methods may also be employed including vaporized hydrogen peroxide (VHP), chlorine dioxide gas, or other mode may be employed. Each methodology has specific requirements for room and HVAC-system preparation, location of equipment, cycle time, supplemental ventilation, and other factors. The effectiveness of the system is impacted by room size and shape, casework type, location of decontamination ports, etc. Close coordination with specific equipment manufacturers is required to ensure that the design supports the desired decontamination methodology. Consideration for material incompatibilities and limitations must be taken into account during the design phase. Efficacy must be confirmed through testing during the commissioning and certification phase. Provisions shall be provided for decontaminating of equipment and all other items that cannot be autoclaved.

### 4.9.10 Autoclaves

All biocontainment facilities require autoclaves for the sterilization of waste. The size, location, configuration and number of autoclaves shall be based on program needs.

The optimal arrangement is one or more pass through autoclaves, located at the secondary barrier, with a manufacturer-supplied bioseal. Pass through autoclaves shall not permit door opening on the clean side prior to completion of a validated decontamination cycle. Filters for chamber exhaust shall include means for validation, and all potentially contaminated components shall be configured to minimize dead-legs and to permit in situ

decontamination, including in event of equipment failure. Each autoclave shall incorporate suitable protections to prevent release or exposure to contaminated materials. Autoclaves shall incorporate effluent decontamination design for all cycles to preclude release of chamber fluids (whether liquids or chamber air) prior to validated decontamination. See [Section 8.6.14](#) for additional information. Redundancy is an important consideration. A sink shall be located on the clean side of autoclaves for disposal of sterilized liquid waste. Clean side autoclave doors shall not open directly onto a public corridor, but shall open into a vestibule with doors separating it from the corridor.

A canopy exhaust hood shall be provided above the autoclave door to capture steam and odors. In two-door pass through configurations, a canopy hood is required above the non-containment side door. A second exhaust hood may be required over the containment side door if the program calls for autoclaving materials into the containment barrier. Canopy hoods on the containment side shall be connected to the HEPA-filtered containment zone exhaust system. Canopy hoods on the non-containment side shall be connected to the non-containment exhaust system. Refer to [Section 6.6](#) and [Appendix D](#) for canopy exhaust hood requirements.

Autoclaves shall be designed to prevent escape of chamber contents prior to sterilization. Pressure relief lines shall be discharged to a safe area in accordance with the risk assessment. Autoclaves for high containment applications should be specified with active door gaskets that use steam during operation and compressed air when not in operation; or alternatively, crushed-seal gaskets should be used.

The floor sink for receiving the sterilized chamber condensate shall be located on the clean side of the bioseal, typically in the utility service access space. Refer to [Chapter 8: Plumbing Design](#).

---

### 4.9.11 Equipment

Equipment shall comply with [Section 4.6 Furnishings and Equipment](#) in addition to the following. Equipment dimensions and weight shall be coordinated to ensure that large items can be transported through the path

of travel into the containment zone vestibules. Recessed wall-mounted equipment shall be specified with fully sealed cabinets or back boxes to facilitate sanitation and decontamination, and eliminate air infiltration. Fixed equipment that penetrates the secondary barrier shall be configured so that serviceable components can be accessed from the non-containment side. Equipment shall be installed with required dedicated floor space for access, service and maintenance activities.

**A. Equipment Service:** SOPs shall be identified for decontaminating and servicing equipment. Equipment shall be reviewed for compatibility with decontaminants.

**B. Bioseals:** Equipment that penetrate the secondary barrier shall be provided with a manufacturer-supplied bioseal. Bioseals shall form a continuous, airtight seal bridging a flange welded to the full circumference of the equipment and the barrier partition. Penetrations through the flange for electrical and piping components shall be constructed with gastight fittings. The bioseal shall be structurally stable and capable of containing decontaminating gas. Bioseals for autoclaves, tissue digesters, and other equipment that generate vibration or thermal expansion shall include a mechanically clamped, heat resistant elastomeric gasket to isolate movement and heat. Sufficient space shall be provided around the bioseal for visual inspection, integrity testing, and replacement.

**C. Biological Safety Cabinets:** Recognized standards for Biological Safety Cabinets (BSCs) include the American National Standard for Laboratory Ventilation– ANSI/AIHA Z9.5, and the NSF International Standard/American National Standard for Class II (laminar flow) BSC–NSF/ANSI 49. The standards include basic requirements for the design, construction, and performance of BSCs that are intended to provide personnel, product, and environmental protection; reliable operation, durability, and structural stability; ease of cleaning; and limitations on noise level, illumination, vibration, and motor/blower performance.

BSCs shall be located out of the mainstream of traffic or at the end of aisles to minimize air currents at the cabinet face. BSC locations and clearances shall be in compliance with [Appendix A: Biological Safety Cabinet \(BSC\) Placement Requirements for New Buildings and Renovations](#).

Aerosol challenges shall be conducted within a class III biological safety cabinet or other approved inhalation-exposure equipment capable of withstanding rigorous decontamination using chemicals required by the program. All materials in the containment cabinet shall be decontaminated prior to exiting the cabinet. An in-line double-door sterilizer and a dunk tank or fumigation integral to the BSC may be required based on risk assessment and program requirements.

**D. Liquid Decontamination:** Decontamination of liquid waste may be required for facilities using holding rooms for primary containment, usage of particular select agents, and for other studies, as determined by risk assessment, and subject to approval of DOHS and ORF. Such systems are not typically required at BSL-3.

**E. Pass Through Cabinets:** Pass through cabinets shall be provided with door interlocks and constructed with gastight seals to prevent air migration through the cabinet. Cabinets penetrating the barrier shall be lockable and open into an enclosed, secure space such as the anteroom, fumigation, or sterilizer vestibule. Cantilevered cabinets shall be rigidly supported to prevent movement or deflection that could damage partition integrity. Locate cabinets to allow passage of properly prepared and decontaminated samples across the biocontainment barrier. Cabinets shall be evaluated during design.

**F. Dunk Tanks:** Dunk tanks are not recommended for cross-barrier use in BSL-3 applications due to the ongoing need for maintenance required to ensure that the proper level and efficacy of liquid disinfectant. If utilized, dunk tanks shall be integral to the containment barrier. Dunk tanks shall be lockable and open into an enclosed, secure space such as the anteroom, fumigation, or sterilizer vestibule. Construction of dunk tanks shall be fully welded stainless steel with smooth, cleanable edges. The inside of the tank may be required to have a chemical-resistant high-performance coating. A view panel shall be installed above the dunk tank for visual communication. The depth of the tank partition must exceed the expected maximum pressure differential, and a liquid-level sensor shall be provided.

## 4.9.12 Signage

A hazard sign incorporating the universal symbol for biohazard and designating BSL-3 or ABSL-3 occupancies shall be posted on all entry doors and in any areas where infectious materials are used or stored. Confirm requirements with the program and with DOHS. Additional information required to be posted includes:

1. Access restrictions
2. Name and telephone number for the lab director
3. Special requirements such as required use of PPE, personnel access
4. Listing of biological agents used, as required by institution (at inner anteroom doorway, not visible to a public corridor)

Signage material shall be resistant to degradation by decontaminants. Sign-attachment methods shall permit removal for sanitation, allow for cleaning and decontaminating rear face, or fully seal sign to mounting surface.

Additional signage requirements and specifications are listed in [Appendix M](#).

---

## 4.9.13 Mock-ups

Field installed mock-ups shall be required for the following items:

1. Each type of partition
2. Each type of penetration
3. Each type of surface-mounted device
4. Each type of finish (inside corners, outside corners and wall/floor transitions).
5. Casework
6. Door, door hardware, and frame
7. Each type of sealant application
8. Miscellaneous items including animal drinking-water system components



Mock-up of a typical room or section of room that demonstrates each of these conditions as fully installed is required.

Mock-ups shall be inspected and tested to ensure conformance with all applicable specifications and criteria. Accepted mock-ups shall be used as the basis for evaluating the quality of installed work and shall be maintained on-site until project completion.

---

### 4.9.14 Commissioning

Commissioning shall be provided for all projects that include high containment space in accordance with [Section 1.10 Commissioning](#).

Design documents shall be reviewed at each submittal stage by the commissioning agent, and comments issued to NIH along with subsequent submittal packages.

**A. Barrier Integrity:** Commissioning shall include inspection, pressure leakage testing, and smoke testing of the integrity of the containment barrier including bioseals, device boxes, construction joints, each penetration, material transitions, and other seams and seals.

**B. Finishes:** Finishes shall be inspected to ensure conformance with approved mock-ups. Painted surfaces shall be latex glove tested to ensure that they are free of sharps that may tear PPE. Pull tests shall also be administered to ensure that finishes can resist removal of tape.

**C. Door Hardware:** Door closures, latches, and interlocks shall be inspected and tested to verify compliance with performance requirements. Door hardware shall provide sufficient force to fully latch doors without exceeding ABAAS limitations.

**D. Equipment:** Each item of fixed equipment shall be inspected and tested in situ to verify conformance with specified performance requirements.

**E. Mechanical, Electrical, Plumbing and Other Building Systems:** Refer to [Section 1.10 Commissioning](#), and Chapters 6 through 12 for additional commissioning requirements.

---

### 4.9.15 Certification

Certification is the systematic review of all safety features and processes associated with the laboratory to validate that all facility controls and prudent practices are in place to minimize to the greatest extent possible the risks associated with laboratory operations and the use of biohazardous material. Certification is required prior to initiating use of BSL-3 agents. Annual recertification is also required. To ensure compliance certification, the evaluation process must be ongoing throughout the project and the A/E shall coordinate any requirements necessary at the design stage in collaboration with the project officer (PO) and DOHS to achieve certification.

DOHS certification requirements for containment (BSL-3) laboratories are listed in the “National Institutes of Health Biosafety Level 3 Laboratory Certification Requirements”.



# Chapter 5

---

## Structural Design

# Section 5.1

## Structural Design

---

### Contents

- 5.1.0 Introduction
- 5.1.1 Codes, Standards and Design Guides
- 5.1.2 Planning
- 5.1.3 Prevention of Building Progressive Collapse
- 5.1.4 Blast Resistance Design
- 5.1.5 Anchor Design of Critical Substructures in Tension
- 5.1.6 Below-Grade Extensions
- 5.1.7 Equipment Access
- 5.1.8 Flatness and Levelness of Concrete Floors
- 5.1.9 Geotechnical Report
- 5.1.10 Demolition and Post Installed Holes and Openings in Concrete Construction
- 5.1.11 Primary Structural Support
- 5.1.12 Secondary Structural Support
- 5.1.13 Future Expansion and Alteration
- 5.1.14 Formwork for Reinforced Concrete Construction
- 5.1.15 Use of Recycled Materials in Concrete
- 5.1.16 Additional Requirements
- 5.1.17 Adjacent Construction
- 5.1.18 Design Documentation

## 5.1.0 Introduction

Structural design ensures that local codes and standards for safety are met and structures withstand the expected stresses throughout their lifespan. NIH facilities are designed to be flexible to meet the loading requirements of a facility's change-of-use over time. Structures shall be maintainable and designed for a longer lifespan. A building's structural design is crucial to its performance and its utility as a research facility. Critical assessment of proposed structural framing should reflect future needs.

### 5.1.1 Codes, Standards and Design Guides

The design and construction of NIH facilities shall conform to the latest versions of referenced standards in the International Building Code (IBC) and incorporate best practice recommendations included in industry design guides. Structural concrete systems and material specifications published by the American Concrete Institute (ACI), the Concrete Reinforcing Steel Institute (CRSI), and the Post-Tensioning Institute (PTI) shall be utilized for design and construction. The American Institute of Steel Construction (AISC) Steel Construction Manual and AISC material specifications shall be utilized for structural steel design and construction. The following list of documents is representative but not all-inclusive:

1. "Control of Cracking in Concrete Structure" ACI 224R. American Concrete Institute.
2. "Specifications for Structural Concrete" ACI 301. American Concrete Institute.
3. "Code Requirements for Environmental Engineering Concrete Structure" ACI 350. American Concrete Institute.
4. "Concrete Structures for Containment of Hazardous Materials" ACI 350.2R. American Concrete Institute.
5. "Minimum Design Loads for Buildings and Other Structure" ASCE 7. American Society of Civil Engineers.
6. "Building Code Requirements for Structural Concrete" ACI 318. American Concrete Institute.

7. "The Risk Management Process for Federal Facilities: An Interagency Security Committee Standard" Interagency Security Committee.
8. "Alternate Path Analysis and Design Guidelines for Progressive Collapse Resistance" General Services Administration.
9. "Minimum Anti-Terrorism Standards for Buildings" Department of Defense.
10. "International Building Code" International Code Council, Inc.
11. "International Existing Building Code" International Code Council, Inc.
12. "Post-Tensioning Manual" TAB 1-06. Post-Tensioning Institute.
13. "Steel Design Guide Series II – Floor Vibrations Due to Human Activity" American Institute of Steel Construction.
14. "Steel Construction Manual" American Institute of Steel Construction.

### 5.1.2 Planning

Perform early planning and coordination with the entire design team. Ensure that the structural engineer learns the needs of all disciplines, resolves issues, and develops a discipline-coordinated structural framing system.

Installing new equipment in existing buildings requires considering the suitability of both the permanent equipment location and its travel path through the building to arrive there.

### 5.1.3 Prevention of Building Progressive Collapse

Progressive collapse is the process where the failure of a component of a building's primary structural system causes the over-stressing and failure of one or more adjoining structural components, resulting in a full or partial building collapse. Progressive collapse countermeasures must be implemented at all NIH facilities

(owned or leased) commensurate with the facility’s level of risk in accordance with the Interagency Security Committee Risk Management Process. Refer to [Section 5.1.1 Number 7](#). These guidelines address the need to save lives, prevent injury and protect Federal buildings, functions, and assets by minimizing the potential for progressive collapse. Necessary countermeasures are determined based on a facility-specific risk assessment; see [Section 1.13 Security Requirements and Procedures](#). Analysis for progressive collapse shall follow the General Services Administration (GSA) “Alternate Path Analysis and Design Guidelines for Progressive Collapse Resistance.” Refer to [Section 5.1.1 Number 8](#).

*Rationale: It is necessary to reduce the potential for progressive building collapse from localized structural damage through manmade or natural events.*

## 5.1.4 Blast Resistance Design

Contact the NIH Division of Physical Security Management for requirements.

## 5.1.5 Anchor Design of Critical Substructures in Tension

Critical substructures supported by anchors in tension (e.g., pipe runs, cable support runs, suspended ceilings) shall be designed and tested to prevent progressive collapse. The contractor must determine the load that each anchor is required to carry in tension. The contractor shall test at least 10% (but not less than 3) of each anchor type used. The contractor shall engage an engineer to devise the testing protocol in general conformance with IBC 1708. The anchor shall support a minimum of three times the maximum calculated load. The contractor shall record the results and provide a copy of the report to the NIH. Refer to the IBC for acceptance criteria.

If any anchor fails the test, the installed anchor shall be replaced, and additional testing shall be conducted to the

satisfaction of the anchor designer and NIH. The suitability of the proposed anchor and installation procedures should be reviewed if multiple failures are encountered.

*Rationale: A “domino effect” progressive collapse event must be avoided.*

## 5.1.6 Below-Grade Extensions

Where there will be areas below grade and extending beyond the exterior building walls, the roof of the below-grade spaces shall be designed to support fire-fighting equipment. The live load shall be a minimum of 12 Kpa (250 psf). Concentrated loading from outriggers may be more demanding than the uniform loading for certain structural components. Loading requirements for equipment in use at NIH facilities should be confirmed with the Division of the Fire Marshal (DFM) for construction on NIH campuses and with the Authority Having Jurisdiction for other facilities.

*Rationale: During an emergency response, firefighters must assume that a site is safe for their equipment.*

## 5.1.7 Equipment Access

Plan and provide access for the installation and replacement of unusually heavy and oversized equipment and system components. Equipment may require access hatches, removable wall sections, reinforced floors, etc. along the travel paths. Requirements shall be determined by designers during programming and documented in the Basis of Design. Designers shall ask program staff about and plan appropriately for ‘next generation’ equipment that may be larger or heavier than current equipment.

*Rationale: Foresight into how instruments/equipment can be moved from and into the building horizontally and vertically, including set-up of equipment needed for the move, will be critical to minimizing any building damage that may occur from equipment transport.*

## 5.1.8 Flatness and Levelness of Concrete Floors

All concrete floors shall conform to the minimum requirements in ACI 117 (Specification for Tolerances for Concrete Construction and Materials); 90% compliance with ½” in 10 feet levelness and no area exceeding ¾” in 10 feet. More stringent tolerance limits should be specified (including Ff and Fl limits) where use and/or finish installation requirements dictate.

***Rationale:** Dead level floors specified by critical F numbers are not cost-effective for a typical office floor.*

## 5.1.9 Geotechnical Report

A registered professional geotechnical engineer shall prepare a geotechnical report for every site. Include test borings in soil and rock coring if rock is encountered. Provide information as to the types of soil encountered, allowable bearing pressures, differential and absolute settlements, lateral soil pressures, recommended types of foundations, water table location, drainage requirements, preliminary recommendations for sheeting and shoring, alerts for special foundation problems, and seismic design parameters. Include the geotechnical report in the construction documents.

***Rationale:** Data provided by the geotechnical report results in the selection of a foundation that is the most cost-effective. The report provides information as to whether additional foundation cost is justified if it allows for future vertical expansion.*

## 5.1.10 Demolition and Post Installed Holes and Openings in Concrete Construction

Prior to cutting new holes and openings or conducting selective demolition of existing concrete, the following activities shall occur:

- Locate all embedded reinforcements, electrical conduits, and post-tensioning tendons in the affected areas.
- A licensed structural engineer shall review the effects of proposed concrete alterations and submit written documentation to NIH for review and approval to proceed.

Embedded items can be located non-destructively by detection technologies such as ground-penetrating radar, pachometers, or X-ray as appropriate for project conditions.

In occupied facilities, applications of detection technologies shall be subject to project-specific approval and coordination with restrictions that would affect research. Similar restrictions may apply to various technologies as may impact ARF or other sensitive research (e.g., ultrasonic, radar, loud audible noise, induced vibrations, etc.); detection technologies shall be verified suitable on a project-specific basis.

***Rationale:** Inadvertent cutting of post-tensioned concrete is a safety hazard; if cut, steel strands may eject from the ends of the tubes into which they were placed or otherwise create danger to personnel. No holes shall be cored or other demolition shall occur before the A/E's subcontractor locates the tension strands by means of detection technology. The location of the strands shall be documented under the supervision of a registered structural engineer. Information is to be provided to the structural engineer for designing/ documenting a procedure under which the demolition work is to be done.*

## 5.1.11 Primary Structural Support

Primary structural framing should consist of concrete or steel framing systems. Concrete should be used in levels at and below grade and either concrete or steel at levels above grade. Alternative framing systems may be considered for facilities which are not intended for research applications, subject to NIH approval. Vibration control is a primary consideration for all research facilities. A vibration consultant approved by NIH must be engaged

to evaluate proposed framing systems to satisfy vibration limits associated with the intended use of the facility.

**Rationale:** *Cost/benefit is a major factor in the selection of a framing system; however, equally important is that the structural framing must accommodate the vibration-transmission limitations of the scientific instrumentation to be used presently and in the foreseeable future.*

### 5.1.12 Secondary Structural Support

Secondary structural support for equipment shall consist mainly of structural steel framing that is either hung from the structure above, supported by posts from the floor, or bracketed off adjacent walls. These secondary supports shall be reviewed and approved by the vibration consultant. The design of secondary structural supports shall consider the movement, vibration, maintenance, and seismic forces related to each element supported.

**Rationale:** *Secondary structural support must be adequate to safely carry anticipated loads while accommodating other influences that can affect the performance of the research.*

### 5.1.13 Future Expansion and Alteration

Framing systems, where appropriate, shall allow for building expansion. Specific plans for future vertical or horizontal expansion shall be considered during the planning and predesign stages and accommodated during the design stage. Provision shall be made for the addition of future floors and additions as determined by the NIH on a project specific basis. Drawings must show future expansion plans, including assumed type of construction, gravity, and lateral loadings.

**Rationale:** *Strategies that allow future horizontal and/or vertical expansion provide flexibility to increase future space at less expense.*

### 5.1.14 Formwork for Reinforced Concrete Construction

For all multistory buildings, the A/E shall specify that the design, installation, and removal of formwork require a registered professional engineer. The professional engineer shall work alongside the building contractor to develop and agree on a formwork design, installation, and removal sequence plan before the first-floor concrete is placed.

**Rationale:** *The proper design, installation, and removal of formwork prevents building failure during construction. Most concrete building failures happen during the construction phase, but it rarely occurs after a professionally designed formwork installation and removal sequence plan is executed.*

### 5.1.15 Use of Recycled Materials in Concrete

The NIH encourages the use of recycled materials in concrete; providing the material is cost-effective, its availability will not cause unreasonable delay, and it meets appropriate performance standards. Concrete containing coal fly ash or ground blast furnace slag can be considered for NIH projects.

**Rationale:** *Fly ash is a byproduct of coal combustion. Use of fly ash in concrete promotes sustainable construction with environmental advantages by using this byproduct.*



### 5.1.16 Additional Requirements

**A. Shoring:** Due to potential harm to research/animals, shoring systems for foundations, site utilities, etc. shall not be installed by impact devices unless the contract specifically states impact systems may be used.

**B. Benchmark and Elevation:** For present and future knowledge, indicate the benchmark and its elevation from which all elevations for construction will be measured.

**C. Roof Live Load:** Use the mechanical area design live load for roof areas, with a view to potential future expansion of mechanical areas to adjoining roof areas.

**D. Grid Lines and Graphic Scales:** Provide grid lines, graphic scales, room numbers, and north arrows on all documents to aid interdisciplinary coordination.

---

### 5.1.17 Adjacent Construction

New construction adjacent to existing construction should consider the potential effects on neighboring facilities, including but not limited to snow drift on adjacent roofs, vibration, noise, support of excavation approaches to limit movement, etc. Stakeholders from the adjacent construction should be engaged early to assist with planning and design criteria.

### 5.1.18 Design Documentation

**A. Structural Drawings:** Drawings shall comply with the requirements in IBC chapter 16 and DRM [Section Appendix E: A/E Submission Requirements](#). All plans shall include graphic scales. Concrete beams as well as steel and concrete columns shall be scheduled.

**B. Specifications:** Specifications shall be developed at the design development stage. Detail performance specifications shall be developed at the contract document stage.

**C. Calculations:** Structural calculations shall include design loads along with connection and member analysis and design. Refer to [Section Appendix E: A/E Submission Requirements](#) for additional information and requirements.

**D. Cost Estimates:** Systems cost estimates shall be developed at the design development stage. The quantity takeoff estimates shall be developed at the contract document stage.

**E. Drawing Information:** Coordinate drawings with all other disciplines.

# Section 5.2

## Structural Loads and Demands

---

### Contents

5.2.0 Introduction

5.2.1 Loads

5.2.2 Vibration

5.2.3 Thrust Blocks

## 5.2.0 Introduction

This section identifies the minimum loads and vibration requirements to be used for NIH facilities.

### 5.2.1 Loads

**A. Live Loads:** NIH facilities shall be designed with the potential for future occupancy changes in mind. [Table 5.2.1\(A\)](#) lists the minimum live loads for individual types of spaces. Refer to [5.1.4 Blast Resistance Design](#) for fire-fighting equipment loading considerations.

Compliance with International Building Code (IBC) occupancy/use minimum concentrated live loads is required. Where live loads conflict with the IBC, greater NIH live load requirements shall prevail.

For renovation projects, the live loads of adjacent existing areas shall be noted on the structural plans to aid the contractor in determining allowable construction live loads within staging areas or areas to be accessed during construction or demolition. Specialized equipment loads and requirements shall be verified with the equipment manufacturer. The minimum live loads given in [Table 5.2.1\(A\)](#) shall be used except when higher loads for specific projects are required to meet program requirements. [Table 5.2.1\(A\)](#) indicates design live loads that historically have been appropriate for NIH requirements.

- 1. Live Load Reduction:** Live load reduction shall comply with IBC/IEBC requirements except as indicated. Live load reduction for existing construction being repaired shall conform to the requirements of the code in force when designed unless live load reductions are considered too liberal from an engineering standpoint. Live load reduction for structures undergoing alteration, addition and/or change of occupancy shall conform to the requirements of IBC/IEBC. Live loads for roofs not intended for future expansion shall not be reduced. Roof structures designed for future expansion (and change of occupancy) may be reduced in accordance with the IBC/IEBC.

*Rationale: Live load reduction data provides valuable information regarding column capacities.*

**Table 5.2.1(A) Minimum Live Loads for Individual Types of Space**

Type of Space	Min Live Load (kPa)	Min Live Load (lb/sf)
Animal research facility	5.0	100
Animal research facility with primates	6.0	125
Aquatic facilities	6.0	125
Cage wash	10.0	200
Catwalks (exclusively walking surfaces)	2.0	40
Conference rooms	6.0	125
Dedicated areas for compact file systems	12.0	250
Equipment imaging spaces	10.0	200
Frozen storage, refrigeration areas	10.0	200
Interstitial platform (exclusively walking surfaces)	2.0	40
Laboratories	5.0	100
Loading docks and receiving areas	12.0	250
Mail room	10.0	200
Mechanical areas (or weight of equipment if greater); add 2.5 at housekeeping pad locations	7.5*	150
Offices	5.0	100
Operating rooms	5.0	100
Reception lobby areas	6.0	125
Roofs (not designed for future expansion)	2.0**	40**
Stairs, corridors	5.0	100
Standard file rooms	7.5	150
Storage rooms	7.5	150
Toilet rooms	5.0	100

*\*Design for weight of actual equipment if demand is larger than minimum uniform loading. Tabulated uniform loading does not include allowance for housekeeping pads. Coordinate pad requirements with mechanical engineer. Additional loading shall not be less than 2.5 kpa (50 psf).*

*\*\*Refer to Section 5.1.14.C.*

**B. Dead Loads:** The building shall be designed to support the actual weights of all stationary materials. These include structural materials, finishes, ceilings, partitions, shielding, piping, and ductwork. Assumed weights shall be indicated on the design documents.

1. **Superimposed Dead Loads:** The design of the structure shall specifically account for vertical loads imposed on the building by systems or elements that do not act as part of the primary structural system, such as mechanical and electrical distribution systems, roofing, floor finishes, ceiling systems, partitions (not subject to change), exterior facades, etc. The loads given in [Table 5.2.1\(B\)](#) shall be used as a minimum in the design of the facilities.

*Rationale: This data provides NIH minimum load assumptions for projects.*

**C. Hanging Loads:**

1. Piping and similar mechanical and electrical devices shall be suspended directly from the structural steel framing or supplementary steel members. Loads suspended from open web steel joists shall be suspended from the top chords. Loads exceeding 150 lbs. shall be located at panel points. Alternate locations and load magnitudes require substantiation by structural analysis.
2. For new concrete construction, cast-in inserts shall be considered when hanging items in mechanical rooms, attaching overhead lights equipment in operating rooms, or hanging any heavy loads.
3. Loads exceeding 2 kPa (20 lb./sf) shall be suspended independently of suspended ceiling construction.
4. Powder actuated fasteners shall not be used to support any magnitude of permanent tension loads or large transient tension loads. Expansion anchors may be used to resist

tension loads but are subject to written approval by a registered professional engineer for the specific application. The A/E shall specify that anchor installation shall conform to relevant product evaluation reports (ICC-ES, ESR or equivalent) and the manufacturer's installation requirements, and the contractor shall submit written evidence that installers have been instructed in the correct installation procedures of that manufacture's anchors.

**D. Wind Loads:** The building shall be designed to comply with the IBC/IEBC.

**E. Seismic Loads:** Due to the continued reassessment of seismic design requirements and the specialized nature of NIH facilities, parameters more conservative than those in the IBC/IEBC may be required. NIH-specific seismic design parameters may be required for the following cases:

- New buildings
- Existing buildings being proposed for renovation
  - Entire buildings being proposed for renovation
  - Wings, or section of buildings, to be renovated between expansion joints
- All buildings or sections of buildings classified as risk category IV by IBC
- Additional critical facilities as determined by DTR

The designer shall contact the Division of Technical Resources at the initial stage of the design process to determine whether NIH-specific seismic design parameters are applicable to the project and the details of those parameters if so.

For all other cases, seismic loads shall be determined using the provisions of the IBC for the seismic area in which the project is located.

**Table 5.2.1(B) Minimum Superimposed Dead Loads for Building Systems**

Building System	Min Dead Load (kPa)	Min Dead Load (lb/sf)
Ceilings	0.25	5
Suspended MEP systems	0.75	15
Partitions (not subject to change, excluding CMU & concrete)	1.00	20
Roofing	1.00	20
Brick facade with backup	3.00	60
Curtain wall	1.00	20
CMU partition walls	2.50*	50

\*CMU and concrete partitions shall consider their actual weight in design

MEP = Mechanical/electrical/plumbing; CMU = concrete masonry units.

**F. Snow Loads:** The building shall be designed for the geographic ground snow load for the area indicated by the IBC. The effects of sliding and drifting snow shall be incorporated in the design. Changes in snow loading on existing structures caused by new construction shall be considered. A licensed structural engineer shall evaluate the existing structure and submit recommendations for alterations or strengthening, if required.

**G. Drawing Requirements:** All loads for new construction and altered existing construction shall be indicated on the drawings. Applicable floor and roof gravity loads, including loads assumed for future expansion, shall be indicated on each plan or on separate loading summary plans. The distribution and extent of each load shall be clearly identified. Design loads for existing construction, which may be required by the contractor for design of temporary construction (shoring, bracing, etc.), shall also be indicated. See [Appendix E: A/E Submission Requirements](#) for complete list.

**Table 5.2.2 Recommended Floor Vibration Velocity Limits for Various Space Usages**

Space or Equipment Type	Vibration Velocity Limits (µm/s)	Structural Criterion "kfm" (kips/in-s)
Animal research facility	100	3,200
Bench microscopes > 400× mag & optical equipment on isolation tables	25	12,800
Bench scopes ≤ 100× mag	50	6,400
Bench scopes up to 400× mag	25	12,800
Electron microscope > 30,000× mag, mass spectrometers, cell implant	6	51,200
Electron microscope ≤ 30,000× mag	12	25,600
Eye surgery, neurosurgery	25	25,600
General laboratory	50	6,400
Laser-based optical systems	12	25,600
Microscope core (EM laser)	25	12,500
MRI and NMR – SOG	SOG	–
General surgery	25	12,500
Rodent behavioral & holding rooms	50	6,400
Super microscope – very low – SOG	SOG	–

Mag = Magnification; EM = electron microscopy; MRI = magnetic resonance imaging; NMR = nuclear magnetic resonance; SOG = slab on-grade; µm/s = micrometers/second; kips/in-s = kips/inch second

## 5.2.2 Vibration

As building materials improve and require less mass and depth to achieve necessary strength results, vibration transmission, which can affect occupants and research, increases. Consequently, vibration transmission must be thoroughly addressed at the earliest project planning and design stage. Discussion should include all design disciplines and building users.

The structural system shall be stiff to the extent that any transmitted vibration occurs at high frequencies, as high frequencies can be dampened with instrumentation vibration dampening systems and isolation tables, unlike vibrations occurring at lower frequencies. To control the vibrations transmitted into laboratories and animal research facility spaces, the A/E shall:

1. Design a structural system with reduced column spacing
2. Isolate laboratory spaces from sources of vibration
3. Locate vibration-sensitive equipment on slab-on-grade and/or remote from high-frequency vibration sources (elevators, HVAC equipment, etc.)
4. Locate vibration-sensitive equipment near columns on framed floors
5. Avoid combining corridors and laboratory spans in the same structural bay on framed floors

Table 5.2.2 provides the recommended floor vibration velocity limits for various space usages that shall be met using the following criteria:

1. Walking pace for a closed corridor (a corridor with walls on both sides and doors on either or both walls) at 90 steps/minute/
2. Walking pace for an open or “ghost” corridor (a corridor with a wall on one side, with or without doors, and the ends of laboratory benches or other laboratory paraphernalia on the opposite side) at 75 steps/minute
3. Walking pace for cross aisles (walkways between laboratory benches) at 60 steps/minute

Areas required to be sensitive to vibration transmission shall be designed with consideration for adjacent equipment, other sources of vibration, and operations. The A/E shall contract with an NIH-approved independent consultant specializing in vibration analysis and control to perform an analysis of the vibration response on the proposed structure for all laboratory and animal research construction projects.

The vibration consultant shall converse with structural engineers for information regarding the building design and its anticipated responses to wind forces. The consultant shall address issues relative to vibration-sensitive equipment and specialized functions such as nuclear magnetic resonance (NMR), neurosurgery, eye surgery, and mass spectrometry. Consideration shall also be given to the vibration of floor-framing systems caused by mechanical and electrical equipment such as pumps, chillers, fans, emergency generators, and transformers, as well as other sources such as foot traffic, parking garage traffic, and movement of heavy equipment. Locating certain equipment on-grade may be ideal to control vibration. The vibration consultant should address measures necessary to avoid vibration transmission in on-grade applications.

Structural systems of all construction types must be evaluated for vibration prior to implementation.

***Rationale:** This communicates to the building designers the maximum permitted vibration transmission allowable for the successful operation of sensitive facilities.*

## 5.2.3 Thrust Blocks

The structural engineer and the heating, ventilating, and air conditioning (HVAC)/plumbing engineers should work in close coordination to design the thrust blocks needed for the piping systems inside and outside the building.



# Section 5.3

## Animal Research Facilities

---

### Contents

5.3.0 Introduction

5.3.1 Structural Bay Dimensions

5.3.2 Location

5.3.3 Vibration

5.3.4 Floor Slab Depressions

5.3.5 Prevention of Progressive Collapse

5.3.6 Security

## 5.3.0 Introduction

Animal research facilities are sensitive to vibration transmission and require the utmost consideration when selecting a structural framing system. Their designs should be flexible and consider future expansion and alteration. Consideration should be given to large equipment installation and removal, noise transmission, and abatement (see [Section 5.1.2 Planning](#)).

## 5.3.1 Structural Bay Dimensions

Structural bay dimensions shall be carefully evaluated. The A/E shall consider the optimal bay dimensions of animal facility spaces, which may vary from the optimal dimensions of other building functions. Considerations should include functional requirements and room configurations, utility and service distribution, and future expansion plans. The A/E shall strive to have multiple planning modules that are compatible with primary building module dimensions for maximum flexibility and allow uniform points of connection for animal research facility services.

*Rationale: The structural design must accommodate the architectural rationale for efficient operation of the ARF.*

## 5.3.2 Location

The A/E shall strive to locate animal research facilities on on-grade-supported slabs in order to reduce vibration concerns. Provide adequate pits required for cage and rack processing and eliminate the risk of water leakage to lower levels.

## 5.3.3 Vibration

Animals are sensitive to vibration transmission. Consult with the researchers regarding vibration levels

acceptable for animals. Vibration transmission control is critical for a successful outcome when selecting structural systems. Refer to [Section 5.2.2 Vibration](#) for requirements.

## 5.3.4 Floor Slab Depressions

**A. Floor Depressions/Topping Slabs:** Floor depressions and/or topping slabs shall be evaluated for use in special-finish areas, wet areas, or areas exposed to materials that may deteriorate the structural floor slab. Floor depressions shall be reviewed for equipment requirements to allow for ease of movement of equipment. Floor slabs shall slope to accommodate drainage pits and shall be provided in cage wash areas to optimize operations. Suitable protection and reinforcement of the concrete shall be provided in high-temperature cage wash areas as well as in areas employing salt water in conjunction with research.

**B. Floor Areas Subject to Salt Water:** Floor areas where salt water is in frequent use require protection from corrosion of the embedded steel reinforcement. At least one of the following measures should be implemented:

- Reinforcement shall be epoxy coated.
- Concrete mixture designs shall be optimized to reduce porosity (including use of supplementary cementitious materials).
- Consider incorporation of corrosion inhibitor admixture in the concrete.

*Rationale: Animal research facilities have unique requirements; consequently, it is critical the structural engineer closely coordinate with the other design disciplines.*

## 5.3.5 Prevention of Progressive Collapse

Conform to the requirements of [Section 5.1.3 Prevention of Building Progressive Collapse](#).

### **5.3.6 Security**

The security level of design for all biomedical laboratories and ARFs shall result from project-specific risk assessment. The A/E shall use the existing baseline threat assessment provided by the Division of Physical Security Management (DPSM) for the preparation of an updated threat assessment.

# Section 5.4

## BSL-3 and ABSL-3 Biocontainment

---

### Contents

5.4.0 Introduction

5.4.1 Codes and Standards

5.4.2 Standards of Quality

5.4.3 Prevention of Progressive Collapse

5.4.4 Serviceability

5.4.5 Loads

5.4.6 Importance Factors

5.4.7 Shielding

5.4.8 Other Requirements

## 5.4.0 Introduction

Biosafety Level 3 (BSL-3) and Animal Biosafety Level 3 (ABSL-3) facilities must exceed conventional structural requirements and require maximum containment measures.

### 5.4.1 Codes and Standards

The primary structural system for NIH BSL-3 and ABSL-3 facilities shall be designed and constructed to meet the strength and serviceability requirements of the facilities' program and conform to codes and standards referenced in [Section 5.1.1 Codes, Standards and Design Guides](#). The framing systems shall have operational demands placed upon them that exceed those for conventional construction, including:

1. Providing a suitable durable substrate for the containment envelope in laboratory areas
2. Minimizing crack propagation in the structural substrate of containment areas
3. Providing pinhole-free surfaces
4. Providing adequate shielding for specific instrumentation and imaging equipment to be utilized in the facilities
5. Providing a structural framing system familiar to local qualified contractors to ensure quality results

### 5.4.2 Standards of Quality

The standards for quality in BSL-3 and ABSL-3 facilities shall be current and the most rigorous industry standards applicable to laboratory construction.

### 5.4.3 Prevention of Progressive Collapse

Conform to the requirements of [Section 5.1.3 Prevention of Building Progressive Collapse](#).

### 5.4.4 Serviceability

The building structure shall be designed to prevent structural deflections and movements that will allow for surface or structural cracking, increase the cost of interior finishing, cause discomfort or concern to occupants, increase wear or damage to exterior building systems, or affect facility operations.

**A. Deflections:** Deflections shall be in accordance with those noted in [Table 5.4.5](#) which indicates maximum deflection of surfaces for acceptable appearance; however, greater deflections may be structurally safe.

**Table 5.4.5 Total Calculated Deflections**

Calculated Deflection under Loading Types	Total Calculated Deflection	Max Deflection (mm [in.])
Calculated deflection for design dead load	< Span length/360	≤ 25 (1)
Calculated deflection for design live load	< Span length/360	≤ 25 (1)
Total calculated deflection of floor system for total design load including time effects	< Span length/240	≤ 38 (1.5)
Vertical deflection for superimposed dead loads & live loads for structural supporting masonry	= Span length/600	= Span length/600

**B. Drift:** The calculated building drift when subjected to code-level wind loads should be less than the floor height/400. The calculated building drift when subjected to code-level seismic loads must meet the requirements of ASCE 7.

### 5.4.5 Loads

NIH BSL-3 and ABSL-3 facilities shall be designed per [Section 5.2 Structural Loads and Demands](#), except for the following:

**A. Live Loads:** No live load reduction is permitted.

## 5.4.6 Importance Factors

BSL-3 and ABSL-3 facilities shall be classified per the risk assessment.

---

## 5.4.7 Shielding

Provide adequate shielding for instrumentation or imaging equipment that emit electromagnetic and radiation waves to ensure the safety of personnel and accurate operation of equipment.

---

## 5.4.8 Other Requirements

The A/E shall refer to [Section 2.5 Biocontainment Facility Predesign](#), [Section 2.6 Biocontainment Facility Design](#), and the preceding sections of Chapter 5 and decide all applicable provisions that are to be incorporated into the design of the biocontainment facility.



# Chapter 6

---

## Mechanical Design

# Section 6.1

## Heating, Ventilation, and Air Conditioning Design

---

### Contents

- 6.1.0 Introduction
- 6.1.1 Heating, Ventilation, and Air Conditioning System Standards and Definitions for NIH Facilities
- 6.1.2 General Planning Requirements
- 6.1.3 Heating and Cooling Load Calculations
- 6.1.4 Animal Population Density
- 6.1.5 Occupancy Loads
- 6.1.6 Lighting Loads
- 6.1.7 Outdoor Design Conditions
- 6.1.8 HVAC System Design Requirements
- 6.1.9 Indoor Design Conditions
- 6.1.10 Indoor Design Conditions for Administrative Areas
- 6.1.11 Ventilation Rates
- 6.1.12 Individual Ventilated Cages
- 6.1.13 Relative Room Pressurization
- 6.1.14 Air Distribution Systems
- 6.1.15 Anterooms
- 6.1.16 Program Equipment
- 6.1.17 Environmental Rooms
- 6.1.18 HVAC Design for Equipment Rooms
- 6.1.19 Mechanical Equipment Location and Access
- 6.1.20 Heating Systems
- 6.1.21 Cooling Systems
- 6.1.22 Exhaust Air Systems
- 6.1.23 Energy Conservation, Efficiency, and Recovery
- 6.1.24 Systems Failure and Disaster Mitigation

## 6.1.0 Introduction

The primary function of the heating, ventilation and air conditioning (HVAC) systems in NIH facilities is to provide a safe and comfortable environment for all occupants. HVAC at research facilities has the additional task of protecting personnel, animals, and the outside community from infectious agents and toxic chemicals. In an animal research facility (ARF), the HVAC system provides a stabilized macroenvironment (room) and microenvironment (cage) for the animals.

The HVAC design shall be commensurate with the laboratory function and the recommended biosafety level for the agents stored or used. As risk of aerosol transmission increases, higher levels of secondary containment may become necessary to prevent infectious agents from escaping into the environment.

### 6.1.1 Heating, Ventilation, and Air Conditioning System Standards and Definitions for NIH Facilities

**A. Criteria:** HVAC systems for all NIH facilities shall be designed to achieve the following minimum general criteria:

1. Maintain space temperature and humidity at the required set points and filtration at prescribed levels
2. Be reliable maintainable, redundant, while operating without interruption and with a proper control system
3. Meet federal sustainable design and energy conservation standards and mandates
4. Maintain prescribed space background noise and vibration criteria generated by HVAC systems
5. Provide ventilation to remove fumes, odors, and airborne contaminants

**B. Facility Specific Requirements:** Guidance and requirements vary depending on the facility type and

research conducted. Additional guidance for common NIH research facilities are defined below.

1. **Biomedical Laboratory Requirements:** Biomedical laboratory spaces shall meet the requirements described herein and the latest *Biosafety in Microbiological and Biomedical Laboratories (BMBL)*. The minimum bio-safety level for all laboratory research facilities at the NIH is BSL-2.
2. **ARF Requirements:** ARFs shall meet the requirements described herein and the latest *Guide for the Care and Use of Laboratory Animals* published by the National Research Council (NRC).
3. **Teaching Lab Requirements:** The design of teaching laboratories shall be based on requirements described herein and the latest BMBL (BSL-2 level minimum) and on the hazard assessment made in conjunction with the users and Division of Occupational Health and Safety (DOHS).
4. **Clinical Lab Requirements:** The design of clinical laboratories and diagnostic laboratories located within a hospital environment shall be based on the requirements described herein and the latest *BMBL* (BSL-2 minimum). All other clinical functions such as surgery areas, waiting rooms, etc. shall be based on the latest Facility Guidelines Institute (FGI) standards. Ventilation shall follow the latest American Society of Heating, Refrigerating and Air Conditioning Engineers (ASHRAE) 170 standards. Where infectious agents or biohazard materials or hazardous chemicals are involved, the A/E shall follow appropriate requirements per BMBL biosafety levels, the *DRM* requirements, and consult with the users and the DOHS.
5. **Datacenter Requirements:** Datacenter design shall follow the latest ASHRAE guidelines and the *NIH Sustainability Data Center Design Guide* (<http://orf.od.nih.gov/POLICIESANDGUIDELINES/Pages/NIH-Sustainable-Data-Center-Design-Guide.aspx>). Data centers shall follow the Uptime Institutes Tier Classification System that sets appropriate

criteria for cooling, maintenance and capability to withstand a fault or failure.

6. **Pharmacy Compounding Facility:** See [Chapter 13: Aseptic Production Facilities](#).
7. **Human Cellular and Gene Therapy Processing Facility:** See [Chapter 13: Aseptic Production Facilities](#).
8. **Administrative Buildings/Spaces Requirements:** The design of administrative buildings and spaces shall be based on requirements described herein, the applicable ASHRAE standards, and shall comply with the latest international and local mechanical codes.

## 6.1.2 General Planning Requirements

**A. Systems Design:** The arrangement of HVAC systems shall ensure maximum reliability, operational flexibility, adaptability, and capacity for renovation; allow service to occur outside critical containment spaces and clean spaces; consider service access restrictions and security requirements; and minimize potential for disruption due to single point failures and routine maintenance. Designs shall accommodate future program renovations, expansions, serviceability, and changes of equipment by considering future capacity allowances including sizing and arrangement of utility services, main and branch duct systems, equipment room space planning and interdisciplinary coordination. The design intent shall be sufficiently documented, including explanation of provisions to facilitate projected future requirements.

***Rationale:** The arrangement of HVAC systems shall be coordinated with the arrangement of the laboratory planning modules to promote operational flexibility. Such planning should be documented so that the intended provisions may be understood and maintained. Thoughtful consideration of access restrictions and security issues helps to minimize their impact on facility operations.*

## 6.1.3 Heating and Cooling Load Calculations

The purpose of determining the actual equipment load data is to right-size the HVAC equipment which lowers initial construction costs as well as life cycle energy costs.

**A. Heating and Cooling Load Calculations:** Complete heating and cooling load calculations and a vapor drive study (where applicable) shall be prepared for each space within a design program and presented in a format similar to that outlined in the *ASHRAE Handbook of Fundamentals*. Heating and cooling load calculations are required for all projects to establish capacity for equipment and provide a reference for system modifications. Calculations shall include, but are not limited to indoor and outdoor design parameters, heat gains and heat losses, supply and exhaust requirements for central systems, and for each area of the facility, humidification and dehumidification requirements, and heat recovery.

**B. Individual Room Calculations:** Individual room calculations shall be generated and summarized on a system basis and presented with a block load to define the peak system load.

**C. Load Summary Sheets:** Load summary sheets shall indicate area of individual rooms, supply air quantity, L/s (cfm), air changes per hour (ACH), and corresponding exhaust air quantity.

### 6.1.3.1 Laboratory Equipment Cooling Loads

**A. Cooling Load:** The HVAC system shall provide, as a minimum, cooling for 86 Watts (W) per m<sup>2</sup> (8 W per ft.<sup>2</sup>) of heat release from equipment or cooling from actual calculated load, whichever is greater. The A/E shall use equipment data for calculating actual loads.

***Rationale:** The minimum 86 W/m<sup>2</sup> (8 W/ft.<sup>2</sup>) for equipment load may be used for generic research labs and as a planning tool where majority of the equipment has not yet been specified. Labs are equipment intensive and prone to equipment “creep” as scientists add more equipment over time.*

**B. Equipment Cooling Load:** Detailed and complete inventory of all laboratory equipment planned for installation shall be obtained and used to calculate the cooling load from equipment. Appropriate usage and diversity factors shall be used. Cooling load from equipment is not the same as nameplate ratings and if nameplate ratings are used they should be de-rated accordingly. If snorkel exhaust or localized exhaust is used near equipment, the convective portion of the equipment can be discounted from the space cooling load. Heat from equipment that is directly vented or heat from water-cooled equipment should not be considered part of the heat release into the room. A/E shall include diversity and usage factors for each space in the calculations.

***Rationale:** To avoid grossly overestimating actual equipment loads, heating and cooling load calculations should not be based on a worst-case scenario assumed as a result of incomplete data provided on nameplates, heat release data, or usage factors. Instantaneous peak loads should not be used as the basis for calculating heat release. The average peak load is more important because generally, space temperatures are not sensitive to instantaneous peaks of a few seconds; therefore, it is unnecessary to size HVAC systems based on peak instantaneous power. It is rare for all equipment to operate simultaneously, and most equipment operates with duty cycles below nameplate ratings.*

**C. Rooms with Higher Cooling Loads:** The following rooms used for laboratory support, often having higher than normal cooling loads. The A/E shall evaluate the use of supplemental cooling units to offset excessive sensible loads affecting these areas while maintaining minimum ventilation requirements. If potential decontamination of the spaces are required, supplemental units shall not be used.

- Common equipment rooms (freezer rooms, shared equipment rooms, etc.)
- Autoclave rooms
- “Clean” and “dirty” cage wash rooms
- Glassware washing rooms
- Special function rooms
- Electron microscope rooms

- Bioinformatics/robotics labs
- Labs with physics-based equipment, e.g., lasers, optics, or nuclear material
- Tissue Culture Rooms (containing Biological Safety Cabinets [BSCs] and incubators)

### 6.1.3.2 Animal Room Cooling Loads

The central HVAC system shall be able to remove both sensible and latent heat produced by laboratory animals. The total heat gain for animals is a function of weight and the metabolic rate of each animal. Heat generation from animals for the purpose of HVAC load calculations shall be as listed in the ASHRAE *Handbook—HVAC Applications*.

## 6.1.4 Animal Population Density

**A. Typical Module:** A typical 3 m (10 ft.) by 7 m (23 ft.) animal holding module shall be designed to the animal population density as given in Table 6.1.4 Design for Animal Population Density.

**Table 6.1.4 Design for Animal Population Density**

Animal	Animals per Rack	Racks per Module	Animals per Module
Mouse	300	5	1,500
Rat	90	5	450
Guinea pig	40	5	200
Rabbit	8	5	40
Cat	8	5	40
Non-human primate	8	5	40

## 6.1.5 Occupancy Loads

**A. Occupancy/Activity Level:** The A/E shall base HVAC load calculations on the expected occupancy in each space and the activity level as per the ASHRAE *Handbook – Fundamentals*.

## 6.1.6 Lighting Loads

Refer to [Chapter 10: Electrical Design](#) and ASHRAE 90.1 for the lighting load requirements.

## 6.1.7 Outdoor Design Conditions

**A. Outdoor Design Conditions Guidance:** All facilities shall be designed in accordance with the “Climatic Design Information” appendix in the *ASHRAE Handbook–Fundamentals*. For summer conditions, use 0.4% column dry bulb (DB)/mean coincident wet bulb (MCWB) temperatures. For winter conditions, use 99.6% column heating DB temperature. Extreme annual wind speed shall be 1% column. Sizing of evaporative type cooling towers shall be based on 1°C (2°F) higher than the WB temperature shown in the 0.4% column.

**Table 6.1.7 Outdoor Design Conditions**

Season	Temperature °C (°F)	Wind Speed m/s (mph)
Summer	35.0 (95) DB, 25.6 (78) MCWB	5.4 (12)
Winter	- 11.6 (11) DB	4.8 (10)
Evaporative cooling	26.7 (80) WB	n/a

*Abbreviations: DB = dry bulb; MCWB = mean coincident wind speed; N/A = not applicable; WB = wet bulb.*

**B. NIH Specific Outdoor Design Requirements:** See [Table 6.1.7 Outdoor Design Conditions](#) for the outdoor design conditions for the Bethesda and Poolesville campuses.

**C. Air-cooled Condensing Equipment:** All approved outdoor air-cooled condensing equipment for Bethesda and Poolesville shall be designed and selected on the basis of 35°C (95°F) ambient temperature.

## 6.1.8 HVAC System Design Requirements

**A. Working Environment:** HVAC systems shall maintain a safe and comfortable working environment and be capable of adapting to new research initiatives. They shall be easy to maintain, energy-efficient, and, in order to minimize lost research time, they shall be reliable. The A/E shall determine and document in the BOD the degree of flexibility (adaptability) for the lab HVAC system based on discussions with the researchers and project officer (PO).

*Rationale: Research frequently requires changes in operations and programs; therefore, HVAC systems for laboratory and animal facilities must be flexible and adaptable enough to allow for the addition of heat-producing equipment in labs, adding a fume hood or additional ventilated cage racks where necessary.*

**B. Dedicated Air:** HVAC systems for laboratories and ARFs shall include dedicated central air handling systems with 100% outside air, which shall also provide adequate ventilation to offset exhaust air requirements. Laboratory and animal supply air shall not be recirculated or reused for other ventilation needs. Recirculation of air from equipment such as fan coil units and induction units is not permitted in tissue culture rooms where the units are located within the room.

*Exception: Recirculation of laboratory air within the same space from devices such as fan coil units, induction units, or chilled beams is acceptable.*

*Rationale: Laboratories and ARFs at the NIH use and generate hazardous materials, which could present significant risks to the occupants. Laboratory and animal facility air shall not be recirculated to another space or facility to prevent migration of chemical fumes or airborne pathogens and prevent cross-contamination between spaces.*

*Recirculated air potentially harbors bacteria that could contaminate the cultures that are grown and used in tissue culture rooms. Chilled beams are however acceptable in these rooms as they*



*tend to have better condensation control and less potential for harboring bacteria.*

### 6.1.8.1 Design Requirements for Research Laboratory Facilities

**A. Independent HVAC:** HVAC systems for research laboratories shall be independent from other HVAC systems in the building as a safety precaution to avoid the spread of infectious agents.

**B. N + 1 Redundancy:** Central HVAC systems shall be provided with multiple air handling units (AHUs) and exhaust fans to provide redundancy and improve reliability. These systems shall be designed to include manifolded AHUs and exhaust fans to achieve N + 1 redundancy and maintain operation at all times.

***Rationale:** Research studies may be of long duration and require consistent environmental conditions to achieve repeatable results; therefore the failure of the HVAC system is unacceptable. If ventilation and directional airflow are compromised occupants may be exposed to potentially harmful infectious agents. Occupant safety can also be compromised if backup equipment is not provided. Redundancy reduces significant interruptions for repair and routine maintenance of the HVAC system.*

**C. PCR Rooms:** Polymerase Chain Reaction (PCR) laboratories are typically set up as Pre- and Post-PCR in separate rooms. HVAC systems for Pre- and Post-PCR shall not permit recirculation due to risk of cross contamination. Pre-PCR rooms shall be kept at slightly positive pressure to adjacent and the Post-PCR be kept at slightly negative pressure to adjacent to prevent escape of amplicons from the completed PCR samples.

**D. TEM and SEM Microscope Rooms:** Transmission electron microscopes (TEM) and scanning electron microscope (SEM) are high resolution instruments that are extremely sensitive to environmental instabilities such as temperature, vibration, acoustic noise, pressure and magnetic fields because of the long acquisition time for the image or for the need for multiple images. Slight changes in any one of these parameters can cause distortion in the microscopic image. It is important to know the sensitivity of the instrument to be housed in

the facility. HVAC requirements include:

1. N+1 redundancy on ALL major components to keep the environmental chamber at constant temperature, pressure, and humidity.
2. The Control system shall utilize a full proportional-integral derivative (PID) controller. PID controller must be tuned using numerical method such as simplified first order plus dead time (FOPDT) process models.
3. Air handling shall be designed to prevent building air from blowing directly on equipment.
4. Air shall be typically filtered to reduce particle concentrations.
5. Temperature changes required may be less than 0.1 degree Celsius h<sup>-1</sup>.
6. Airflow across the column may be as low as than 20 feet min<sup>-1</sup> – The airflow across the column may vary depending on the type and sensitivity of the equipment.
7. Radiant cooling system is recommended and could be an inexpensive retrofit used in conjunction with a forced air A/C system. The forced air would be used mainly to control humidity. Radiant cooling can control temperature to better than 0.1 degree Celsius and provides exceptional temperature stability.
8. To retrofit a forced air cooling system:
  - a. Provide reheat coil with feedback from the thermo-coupler near the column to reduce fluctuations.
  - b. The inlets might be placed away from the column to avoid unacceptable currents.
  - c. Diffuse the air flow by installing a ceiling with hundreds of small holes across the ceiling (but with none directly above the column) similar to duct sock and arranged to produce laminar flow.
  - d. The cooling cycling must be minimized.
  - e. Temperature probes shall be of highest accuracy.

### 6.1.8.2 Design Requirements for Animal Research Facilities

**A. ARF HVAC Design Guidance:** HVAC design shall meet the requirements of the latest Institute of Laboratory Animal Research (ILAR) guidelines.

**B. Independent HVAC:** HVAC systems for ARFs shall be independent from other HVAC systems in the building. These systems shall be capable of maintaining environmental conditions in any of the holding rooms for any of the species anticipated to be housed in the facility. Animal holding rooms housing rabbits/ferrets within a large rodent or primate facility shall be provided with supplemental cooling to meet the required room temperature.

**C. N+1 Redundancy:** Requirements for N+1 redundancy shall be same as required for research laboratory facilities as specified in [Section 6.1.8.1 Design Requirements for Research Laboratory Facilities](#).

**D. Cage Wash Areas:** HVAC for cage wash areas shall be provided with temperature, humidity and airflow control. Cage wash equipment itself shall be provided with appropriate exhaust requirements as per manufacturers recommendation. Temperature and humidity levels in cage wash areas depend on the work/rest ratio and the level of activity defined by American Conference of Industrial Hygienists (ACGIH). The A/E shall refer to NIH Heat Stress Program guidance for individuals working within such an environment.

**E. Surgical Facilities:** Design of ARF surgical facilities should include consideration for the species to be used, the types of procedures to be performed, the desired throughput or volume of procedures, and the number of people who will work in the suite. Surgery areas provide support function for the ARF and can be utilized for minor or major procedures with survival or non-survival outcomes. Survival surgery must be performed aseptically. Generation of aerosols during surgical procedures must be considered regardless of the potential biohazard associated with the animals. All ventilation air is 100% outside air.

- 1. Operating/Surgical Rooms:** The supply air to operating rooms shall be provided with HEPA filtered air at a minimum of 20 ACH of 100% outside air. Air shall be supplied in the ceiling with a concentration of the laminar airflow over the surgery tables. Low exhaust shall be

provided in at least two locations per operating room. Differential airflow shall be positive to all adjacent areas.

- 2. Sterile Supply Room:** The room temperature and humidity shall be consistent with animal holding rooms. The room shall be provided with a minimum of 10 ACH of 100% outside air. Differential airflow shall be positive to all adjacent areas. Where an autoclave is installed stainless steel canopy exhaust shall be provided.
- 3. Animal Preparation Room:** The room temperature and humidity shall be consistent with animal holding rooms. Room shall be provided with a minimum of 10 ACH of 100% outside air. Differential airflow shall be negative to operating room and positive to the animal facility.
- 4. Post Recovery Room and Surgery Scrub Room:** The room temperature and humidity shall be consistent with animal holding rooms. Room shall be provided with a minimum of 10 ACH of 100% outside air. Differential airflow shall be negative to operating rooms, but positive to adjoining rooms for infection control.

**F. Animal Procedure Rooms:** The room temperature and humidity shall be consistent with animal holding rooms. Room shall be provided with a minimum of 15 ACH of 100% outside air. Differential airflow shall be negative to adjoining spaces, except for procedure rooms used for rodent survival surgery, where room differential pressure is positive to adjacent spaces.

**G. Animal Neurobehavioral Laboratory:** The room temperature and humidity shall be consistent with animal holding rooms. Room shall be provided with a minimum of 15 ACH of 100% outside air. Differential airflow shall be negative to adjoining spaces.

**H. Imaging Rooms:** HVAC for X-ray room, magnetic resonance imaging (MRI), computed tomography (CT), and positron emission tomography (PET) to support animal surgery and non-surgical procedures requires minimum ventilation of 6 ACH of 100% outside air. When imaging rooms are adjacent to surgery suites, the imaging room shall be negative relative the surgery suite. Room temperatures around the magnet shall remain stable and controlled within  $\pm 1^{\circ}\text{C}$  ( $\pm 2^{\circ}\text{F}$ ).

- All magnet rooms shall be provided with an

exhaust pathway should cryogen accidentally quench in the room due to a breach. The emergency exhaust grille shall be located away from the entrance to the room. In addition, the designer shall provide a pressure relief/pressure equalizer to minimize risk of positive pressure entrapment. Both the active and passive exhaust shall be exhausted outdoors.

2. The cryogen quench pipe must be designed with appropriate materials and insulation and be adequately sized to handle the cryogen. All joints and fittings shall be located so they can be inspected. The point of discharge shall be through a weather head fitting that will discharge cryogen towards the roof. Pipes shall be routed to minimize long runs and elbows and be fully coordinated with equipment vendor to ensure complete venting of cryogenic gas to atmosphere. Areas around the quench discharge shall be off limits and signs shall be posted to alert personnel of quench discharge.
3. For most MRI systems, if the magnet quenches the escaping cryogenic gases are ducted to the outside of the building through the quench vent. While quench pipe failures are rare, when they occur the expanding cryogenics can fill and pressurize the magnet room and may cause a life-threatening event to the occupants. Therefore, for large MRIs (> 3 T) or other such equipment containing liquid cryogen, a Helium Quench Pipe Failure analysis is required. Few detailed methodologies exist to evaluate helium quench pipe failure. However, the methodology found within [Exhibit 6.1](#) shall be followed at NIH facilities for MRIs.

***Rationale:** Imaging equipment requires stable room temperature which is typically dictated by the equipment manufacturer. Quenching of the magnets can occur in rooms with MR imagers, can deplete the room of oxygen and cause room pressures to rise suddenly even when magnets are provided with a dedicated quench pipe to the outdoors. Provisions must be made for having direct exhaust to the outdoors. For example, each liter of liquid cryogen expands to approximately 700 liters of cryogen gas when it*

*boils. These safety measures are recommendations taken from ACR (American College of Radiology) 2013 Guidelines of MR Safe Practices.*

**I. Animal Isolation:** Some rooms may be designated as “animal isolation” rooms having a housing chamber with sash fronts or hinged doors. Unidirectional flow or laminar-flow type systems for any of these rooms may also be required.

***Rationale:** Animal isolation rooms are used for infection control and to prevent exposure of personnel to biological agents, allergens, and odors.*

**J. Feed Storage Rooms:** Feed storage rooms shall be temperature and humidity controlled and independently monitored. They are typically maintained at 18°C (65°F) and at 50% RH; however, they may also be refrigerated, similar to environmental rooms. The room shall be pressurized positively to prevent contamination of the product.

## 6.1.9 Indoor Design Conditions

### 6.1.9.1 Laboratory Temperature/Humidity Levels

**A. Laboratory Temperature & Humidity:** All occupied laboratory spaces, unless noted otherwise, shall be designed to maintain the temperature and humidity levels as given in [Table 6.1.9.1 Indoor Design Conditions for Laboratories and ARF Support Areas](#).

**B. Unique Requirements:** Some laboratories conduct special research requiring unique temperature and humidity ranges and control. These special cases shall be evaluated and approved by the NIH on a case-by-case basis. The HVAC system shall be designed to accommodate these unique conditions as they occur. These special requirements shall be reviewed by the Division of Technical Resources (DTR).

**Table 6.1.9.1 Indoor Design Conditions for Laboratories and ARF Support Areas**

Season	Temperature °C (°F)	Relative Humidity %
Summer	23 ± 1 (73 ± 2)	50 ± 5
Winter	21 ± 1 (70 ± 2)	30 ± 5

*Note: Refer to Section 6.1.9.1 B.*

### 6.1.9.2 Animal Research Facility Temperature/Humidity Levels

**A. General ARF Temperature & Humidity Requirements:** Ideally, animal holding rooms shall be capable of housing other anticipated species and the HVAC system shall be capable of maintaining the full range of requirements for varied animal populations. Exposure to wide temperature and humidity fluctuations are detrimental to animal well-being as well as outcomes of research protocols. Unless noted otherwise, the temperature and humidity levels for animal support areas shall be as given in [Table 6.1.9.1 Indoor Design Conditions for Laboratories and ARF Support Areas](#).

**B. ARF Dry Bulb:** The dry bulb temperature range required to accommodate most common research animals is 18–29°C (65–84°F) controlled to ± 1°C (2°F). The dry bulb room temperature shall be selected and maintained near the middle of the ranges as listed in [Table 6.1.9.2 Indoor Design Conditions for Animal Holding Areas](#). These rooms shall be maintained at their specified design conditions at all times and under all load conditions. The dry bulb temperatures listed in [Table 6.1.9.2](#), are broad and generally reflect tolerable limits for common adult laboratory animal species, provided they are housed with adequate resources for behavioral thermoregulation. Deviations from these indoor design conditions must be approved by the staff veterinarian. Species such as tropical reptiles, amphibians and insects may require indoor temperatures that are program specific.

**Table 6.1.9.2 Indoor Design Conditions for Animal Holding Areas**

Study Animal	Temperature °C (°F)	Humidity %RH
Mouse and rat	20–26 (68–79)	35–70
Hamster	20–26 (68–79)	35–70

Study Animal	Temperature °C (°F)	Humidity %RH
Guinea pig	20–26 (68–79)	40–70
Rabbit	16–22 (60–72)	40–70
Dog and cat	18– 29 (64–84)	30–70
Non-human primate	18–29 (64–84)	45–70
Chicken and farm animals	16–27 (60–80)	45–70
Zebrafish	26–29 (78–84)	50–70
Reptiles	Consult with user	Consult with user
Amphibians	Consult with user	Consult with user

*Note: Refer to Section 6.1.9.1 B.*

**C. ARF Humidity:** The space humidity required for common research animals is listed in [Table 6.1.9.2](#) and controlled to ± 5% RH. These ranges can be narrowed based on species. Some tropical species (such as certain non-human primates, reptiles, and amphibians) may require conditions of high relative humidity. Ideally the room humidity shall be selected and maintained near the middle of the ranges as listed in [Table 6.1.9.2](#). It is desirable that most or all of the humidification be produced centrally at or near the AHU and local trim humidifiers should be avoided because they require considerable initial cost and maintenance.

## 6.1.10 Indoor Design Conditions for Administrative Areas

**A. Temperature:** Administrative areas such as general offices, lobbies, corridors, conference rooms, auditoriums, toilets areas, dining, kitchen and cafeteria areas shall be designed for 24°C (75°F) in summer and 21°C (70°F) in winter. Temperature shall be maintained with ± 1°C (2°F) of set point.

**B. Humidity:** Relative humidity in administrative areas shall be designed between 30% and 60% RH and maintained within ± 5% of set point.

### 6.1.10.1 Ventilation Systems and Air Quality in Administrative Areas

**A. Administrative Areas:** Ventilation rates for administrative areas such as offices, conference rooms, etc., shall be calculated based on outdoor air requirements in accordance with ASHRAE Standard 62 and specific requirements based on the manufacturer's recommendation. Ventilation rates for conference rooms shall be based on peak occupancy.

**B. High Occupancy Areas:** High occupancy areas such as large conference rooms, lecture rooms, and auditoriums shall incorporate CO<sub>2</sub>-based demand-control ventilation system to minimize energy consumption.

**B. Air Filtration:** Refer to Section 6.2.5 Air Filtration Systems for filtration requirements for laboratories.

**C. Chemical/Hazardous Sensors:** Chemical and hazardous sensors for reduction of the minimum ACH shall not be used.

*Rationale: Current chemical sensor technology does not adequately detect all toxic/hazardous materials in the air. There are also additional costs associated with frequent recalibration and replacement of these sensors.*

## 6.1.11 Ventilation Rates

### 6.1.11.1 Ventilation Rates and Air Quality in Research Laboratories

**A. Ventilation Rate:** The outdoor air ventilation rate for laboratory space shall be no less than 6 ACH, regardless of space cooling load. This minimum ventilation rate shall be maintained at all times. The ventilation rate for research laboratories is typically driven by multiple factors: fume hood demand, cooling loads, space pressurization and removal of fumes and odors from the laboratory work area. Some laboratories and support areas may require significantly higher ventilation rates to support fume hood demand or to cool dissipated heat from laboratory instruments and equipment. (Refer to "Experimental Study of Ventilation Performance in Laboratories with Chemical Spills" by Jin et al. Available at: <http://orf.od.nih.gov/PoliciesAndGuidelines/Bioenvironmental/Documents/ExperimentalStudyofVentilationPerformanceinlaborat.pdf>)

*Rationale: Minimum ventilation rates provide protection to occupants from chemical vapors associated with accidental chemical spills and splashes. The ventilation rate does not include the dilution airflow required to deal with spills in a primary containment device (such as a fume hood). Some rooms with high hazard levels of materials may require higher than 6 ACH; the A/E should consult with the DOHS.*

### 6.1.11.2 Ventilation in Laboratories Working with Laser Equipment

Rooms where laser equipment is used shall be properly ventilated to avoid buildup of ozone generated from laser and mercury lamps. Ventilation shall maintain room ozone exposure levels no less than required by NIOSH.

*Rationale: Ozone is a toxic gas and even at low concentration may cause irritation to eyes, nose, and throat.*

### 6.1.11.3 Ventilation Systems and Air Quality in Animal Research Facilities

**A. Considerations:** Ventilation systems in ARFs shall be designed to address at a minimum the following factors:

- Animal species and their population
- Required minimum ventilation rate
- Recommended ambient temperature and humidity
- Heating and cooling loads within animal rooms
- Heat gain produced by animals
- Use of microenvironments and the different ventilation methods in animal cages
- Use of fume hoods and/or BSCs
- Animal cage cleaning methods and types of bedding
- Animal examination method
- Airborne contaminants



- Institutional animal care standards
- Allowable noise levels

Consult with staff veterinarian for other influencing factors that may be research specific.

**B. Individual Room Ventilation Rates:** Ventilation rates within each room may vary depending on the animal housed in the room or the room’s function; however, ventilation rates in animal facilities are typically provided at 10–15 ACH. Provision of 10–15 fresh-air changes per hour in animal housing rooms is an acceptable guideline to maintain macroenvironmental air quality by constant volume systems and may also ensure microenvironmental air quality. Although this range is effective in many animal-housing settings, it does not take into account the range of possible heat loads; the species, size, and number of animals involved; the type of primary enclosure and bedding utilized; the frequency of cage-changing; the room dimensions; or the efficiency of air distribution within the macroenvironment and between it and the microenvironment. In some situations, the use of such a broad guideline might over ventilate a macroenvironment containing few animals, thereby wasting energy, or under ventilate a microenvironment containing many animals, allowing heat, moisture, and pollutants to accumulate.

**C. Table 6.1.11.3 Ventilation Rates in Animal Research Facilities<sup>a</sup>** provides the typical ventilation rates for various rooms at an ARF.

**D. Requirements:** Ventilation systems in ARFs shall meet the following requirements:

1. Rooms shall be designed to avoid drafts that could adversely affect animal health.
2. Ventilation systems shall reduce airborne animal hair and particulate count.
3. Air recirculation within animal facilities is prohibited.
4. Refer to [Section 6.2.5 Air Filtration Systems](#) for filtration requirements for animal research facilities
5. Refer to: *Ventilation Design Handbook on Animal Research Facilities using Static Microisolators* (Vols. I and II) November, Farhad Memarzadeh, PhD, PE, NIH

– Office of the Director, ORF Publication, Bethesda, MD, 1998 (<http://orf.od.nih.gov/PoliciesAndGuidelines/Bioenvironmental/Pages/cover.aspx>)

*Rationale: Ventilation provides an adequate supply of oxygen, removes thermal loads from animals, lights and equipment, dilutes gaseous and particulate contaminants, adjusts the moisture content of the room air, and where appropriate provides pressure differential between adjoining spaces. Good conditions within the animal environment tend to minimize unintended stress on animals.*

**Table 6.1.11.3 Ventilation Rates in Animal Research Facilities<sup>a</sup>**

Facilities	Minimum Air Changes per Hour <sup>b</sup>
Small animal, static cage/rack	15
Small animal, ventilated cage/rack	10
Large animal	15
Aquatics (zebrafish)	10
Office/administration support <sup>c</sup>	6
Laboratories	6
Imaging/MRI, CT, PET	6
Surgery – OR’s	20
Equipment and supply room	6
Post operative recovery room	10
Animal prep room	10
Surgery scrub	10
Necropsy	15
Animal procedure room	15

<sup>a</sup>Ventilation rates refer to 100% outside air.

<sup>b</sup>Higher ACH may be required to support fume hood and biological safety cabinet demands and high heat loads

<sup>c</sup>Only if they are an integral part of the animal research facility and the areas are served by 100% outside air units



## 6.1.12 Individual Ventilated Cages

Individual ventilated cages (IVC) provide an optimal microenvironment thereby reducing frequency of cage cleaning and maintaining low concentrations of ammonia, carbon dioxide and stable oxygen.

**A. Ventilated Racks:** For rooms using IVC, it is recommended that the ventilation system be sized by adding the airflow required for the animal cooling/heating loads of fully loaded IVC to the airflow required for other room cooling/heating loads such as lights, equipment, etc. The A/E shall evaluate all anticipated combinations of animals and cage systems; calculate supply air demands for makeup air, ventilation rates, cooling demand, heating demand, and design for whichever criteria results in the highest airflow demand.

**B. System Connections:** System connections to micro-environments shall be designed to maintain the manufacturer's specified criteria.

**C. Fan/Filter Blowers:** Ventilated cage racks may be equipped with self-contained fan/HEPA filter blowers on supply and exhaust. There are multiple configurations for coupling the racks to the building HVAC system. The preferred configuration for coupling IVC with the building HVAC system is via the room air source and direct exhaust connection to allow removal of odor. All direct connections from building exhaust to rack-mounted exhaust blowers must be through a thimble connection and reinforced to prevent ceiling stress cracking and/or damage at the connection penetration.

**D. Noise:** Multiple blowers in the room increase noise which may negatively impact animals. The A/E must consult with the user where multiple blowers are in the same room. Doubling the quantity of blowers adds up to 3 decibels of noise.

***Rationale:** Ventilation provides adequate supply of oxygen, removes thermal loads from animals, lights and equipment, dilutes gaseous and particulate contaminants, adjusts the moisture content of room air and where appropriate provide pressure differential between adjoining spaces.*

## 6.1.13 Relative Room Pressurization

Pressurization is typically required with door closed. Room pressurization is typically achieved using offset and airflow tracking method.

### 6.1.13.1 Relative Room Pressurization within Laboratories

**A. Once-Through Airflow Principle:** Laboratories shall be designed and air balanced so that air flows into the laboratory from adjacent (clean) spaces such as offices, corridors, and non-laboratory spaces. In these facilities, the use of the once-through airflow principle is based on:

1. Use of 100% outdoor air to provide all the room air to be exhausted through laboratory spaces and laboratory containment equipment
2. The capacity of the exhaust air system to handle the simultaneous operation of all laboratory spaces and all laboratory containment equipment
3. Direct airflow from low-hazard areas to high-hazard areas at all times. Air supplied to the corridor and adjacent clean spaces shall be exhausted through the laboratory to achieve effective negative pressurization.

***Rationale:** The control of airflow direction within research laboratory spaces helps reduce the spread of odors, toxic chemicals, and airborne contaminants, as well as protecting personnel and research from toxic and hazardous substances.*

**B. Negative vs. Positive Air Pressure:** Laboratory spaces shall remain at a negative air pressure in relation to corridors and other non-laboratory spaces. Typically, these systems are designed to maintain 47 L/s (100 cfm) airflow from the corridor into each lab module. Administration areas in laboratory buildings shall always be positive with respect to corridors and laboratories. Supply air distribution for corridors shall be sized to offset transfer air to laboratories while maintaining an overall positive building pressure.

**C. Amount of Supply Airflow:** Amount of supply airflow to laboratory spaces shall meet the cooling loads as well as exhaust air requirements. Typically exhaust

airflow requirements would exceed the cooling loads requirements. In this situation, the supply airflow would need to be increased to make up the difference between the cooling airflow and the required exhaust airflow. In cases where the cooling load airflow requirements exceed the required exhaust air rate requirements, supplemental cooling units may be provided.

**D. Special Laboratories:** Special laboratories such as genome DNA processing rooms, PCR rooms, warm rooms, clean laboratories, sterile facilities, etc., may require a different type of relative room pressurization (i.e., radioisotope labs should be maintained at negative 12Pa [0.05 in. w.g.] pressure relative to corridor). Some special laboratories may require positive air pressure in relation to adjacent spaces. In these cases, the use of a personnel entry or anteroom shall be used. These special applications need to be reviewed by the DTR and the DOHS.

### 6.1.13.2 Relative Room Pressurization within Animal Research Facilities

**A. Adaptation/Protection:** Relative pressurization within ARFs is a series of complex relationships that may change as research and animal populations change. The HVAC system shall be capable of maintaining these relative pressure relationships and of adapting as facility utilization changes. In a single-corridor conventional facility or surgical rooms where there is potential for surgery involving biohazardous exposure, the ability to automatically reverse room-air pressurization relative to the corridor is highly desirable. If reverse room-air pressurization is incorporated into the design it should be restricted to action by facility or maintenance personnel who will subsequently verify pressure differential of rooms adjoining the corridor. In addition, animal spaces shall be protected against contamination from outside sources, including particulates brought in by the HVAC airflow. The pressure relationships for animal care areas including procedure rooms, imaging rooms and surgical areas are described in [Section 6.1.8.2 Design Requirements for Animal Research Facilities](#). Relative pressurization of the ARF is also dependent on whether the facility is managed as a conventional or a barrier facility.

**B. Infectious Populations:** Potentially infectious populations shall be maintained at a negative pressure to prevent contamination of other animal populations.

Depending on the nature of the infectious agents involved in the research, these areas may be required to meet the design criteria for biohazard containment facilities as outlined in the BMBL. The use of ante-rooms or microisolator housing units may be required to maintain these special conditions.

**C. Conventional Facilities:** In a conventional facility housing “dirty” animals, rooms shall remain at a negative air pressure relative to corridor and other non-animal spaces. Routes of transportation for dirty animals or equipment such as service corridors, cage and rack washing, and decontamination and wasteholding areas shall be maintained at a negative pressure to the corridor. Clean areas of the facility including the clean side of cage and rack washing, clean corridors, bedding dispensing, and feed preparation areas shall be positive to animal holding spaces and soiled areas.

*Rationale: Conventional facility animal rooms housing “dirty” animals are balanced negative to the corridor to contain airborne contaminant, reduce animal allergens and odors and thereby reducing personnel exposure to animal allergens.*

**D. Barrier Facilities:** Barrier facilities having rooms with “clean” animals (such as for transgenic or immunosuppressed populations) shall be maintained at a positive pressure to the corridor and may also require special filtration of supply air.

**E. Anterooms:** In a conventional facility housing “clean” animals, anterooms shall remain at positive pressure relative to the corridor. When these rooms are maintained at positive pressure in corridors and where other rooms house “dirty” animals, an anteroom or similar feature shall be placed between the animal room and the corridor, unless specifically approved by animal program and DOHS.

**F. Dirty Elevator Shafts:** Dirty elevator shafts shall have negative air pressurization in relation to all surrounding areas unless entrance to elevators is from a vestibule which buffers the changes in differential pressure created by the movement of the elevators.

**G. Special Pressurization Requirements:** Some areas other than the ones described above may have special pressurization requirements and shall be addressed individually by the DTR and DOHS.

### 6.1.13.3 Relative Room Pressurization within Administrative Areas

**A. Service Rooms:** Toilets, janitor’s closets, showers, locker rooms, housekeeping closets, mail-sorting rooms shall be kept at negative pressure to surrounding areas.

**B. Kitchen Areas:** Kitchen areas shall be negative pressure to the adjacent dining areas, serving areas, and corridor. Dishwashing areas shall be kept negative to the kitchen areas.

**C. Entrance Areas:** Entrance vestibules, atriums, and lobby areas in buildings shall be adequately heated and cooled and be positively pressurized relative to the outdoors and be negatively pressurized relative to adjacent indoor spaces.

## 6.1.14 Air Distribution Systems

**A. Circulation:** Supply, exhaust, and outside air shall be ducted for all spaces, i.e., not taken through ceiling plenums, shafts, mechanical equipment rooms, corridors, or furred spaces. The circulation of air directly between areas is not permitted, except into toilet rooms, locker rooms, and janitor’s closets. Circulation may also occur between adjacent corridors into a negative pressure area or out of positive pressure areas. Circulation of air shall not replace the minimum ventilation requirements set by ASHRAE 62.1.

**B. Supply Air:** Supply air distribution system shall be designed to minimize turbulence and to avoid having an impact on the performance and function of primary containment equipment such as chemical fume hoods and BSCs.

1. Air outlets shall not discharge into the face of fume hoods or BSCs. The cross draft velocity at 235 mm (2 ft.) from the face of the fume hood or BSC shall not be greater than 15.2 m (50 ft.) per minute measured at 1.5 m (5 ft.) above finished floor.

**C. Plenums/Air Shafts:** Plenums and air shafts for distribution of supply or exhaust air are prohibited in NIH laboratories and ARFs. Common outdoor air ductwork may be permitted for outdoor air intakes to

multiple AHUs due to space constraints and building configuration.

*Rationale: This is to limit the potential for cross-contamination of airstreams.*

**D. Corridors:** Corridors shall be provided with conditioned air. The quantity of conditioned air to the corridors and lobby area shall be sufficient to maintain an overall positive building pressure.

*Rationale: Providing conditioned air to the corridors helps to maintain design temperatures and to make up air for negatively pressurized rooms opening directly to the corridor.*

**E. Prevention of Cross Contamination:** In laboratories and ARFs distribution shall prevent cross-contamination between individual spaces. Air shall flow from areas of least contamination to areas of higher contamination potential, i.e., from “clean” to “dirty” areas.

**F. Air Supply Devices:** In laboratories and ARFs arrange air supply devices at ceiling level or close to ceiling level if located on sidewalls. Air distribution and diffusion devices shall be selected to minimize temperature gradients and air turbulence. In animal facilities the A/E shall ensure that the system does not create drafts on the animals and the airflow is uniform in nature.

### 6.1.14.1 Laboratory Air Distribution

**A. Laboratory Requirements:** Laboratory spaces shall be designed with special attention to air quality, room acoustics, supply air temperature, supply air humidity, airflow quantities, air velocity, and air diffusion and distribution within the space. In addition, space air distribution shall meet the following requirements:

1. Large quantities of supply air in laboratories near fume hoods or equipment sensitive areas can best be delivered through perforated plate air outlets or radial displacement diffusers.

*Rationale: Perforated plate air outlets or radial displacement diffusers provide low velocity airflow patterns near fume hoods or critical equipment.*

2. Space temperature and humidity shall be uniform throughout the space. Space temperature shall be monitored in each individual room.
3. Each individual lab space shall be provided with dedicated temperature controls. This shall include the dedicated air-terminal units for the supply and exhaust air.

#### 6.1.14.2 Animal Room Air Distribution

**A. ARF Requirements:** Animal facilities shall be designed with special attention to air quality, room acoustics, supply air temperature, supply air humidity, airflow quantities, air velocity, and air diffusion and distribution within the space. In addition, space air distribution shall meet the following requirements:

1. Air distribution and diffusion devices shall be selected to minimize temperature differentials in the space, minimize drafts on animals, avoid interfering with experiments or primary containment devices and suppress mixing and recirculation of air. High induction/entrainment supply diffusers, such as typically used in commercial offices should be avoided.

*Rationale: Mixing and recirculation of air in animal room results in recirculated air staying in the room for a long time before it is exhausted.*

2. Air exhaust devices shall be a combination of exhaust drops for ventilated cage racks (where applicable) and general room exhaust grilles. The exhaust drops or thimbles shall penetrate the ceiling and shall be constructed of 316 stainless steel. Where ductwork serves multiple racks, a balancing damper or pressure-independent valve should be provided. A load simulator can also be provided to allow disconnect/removal of a single rack from the system.
3. Exhaust air grilles shall be provided with coarse disposable filters to protect air ducts and heat recovery coils. Course filters should be limited to animal holding rooms and located near the floor level to prevent maintenance staff from using ladders to replace filters.
4. Individual room temperature and humidity

sensors for animal holding rooms shall be located within the room unless justified to be placed in the general exhaust ductwork.

5. Space temperature and humidity shall be consistent throughout the room. Temperature and humidity shall be controlled, monitored, alarmable, and recorded (trended) in each individual animal holding room.
6. Exposed HVAC ductwork is generally not recommended in animal rooms. If constructed, it shall be of 316 stainless steel to facilitate cleaning.

**B. Additional Resources:** Refer to the ORF Bioenvironmental Studies website: <http://orf.od.nih.gov/PoliciesAndGuidelines/Bioenvironmental/> for additional information and to the following article:

1. “Analysis of Air Supply Type and Exhaust Location in Laboratory Animal Research Facilities Using CFD”, Andrew Manning, Ph.D., Farhad Memarzadeh, Ph.D., P.E., Gerald L. Riskowski, Ph.D., P.E.

#### 6.1.14.3 Administrative Rooms Air Distribution

**A. Requirements:** Air distribution in administrative areas shall be designed with special attention to air quality, room acoustics, supply air temperature, supply air humidity, air velocity, and air diffusion and distribution within the space.

**B. Airside Economizers:** Air distribution system serving administrative areas shall have airside economizers in accordance with ASHRAE 90.1.

**C. Diffusers:** Ceiling diffusers shall be designed for variable air volume (VAV) air distribution.

**D. Air Diffusion Performance Index:** The location and ranges for outlet devices shall be selected to ensure a minimum air diffusion performance index (ADPI) value of 80% during full load and part load conditions in accordance with the test procedures specified in ASHRAE Standard 113-2005.

**E. Ducted Returns:** Ducted returns shall be utilized in all areas. The exception shall be for renovation projects where the existing systems are designed as plenum

returns and where it would be impractical to upgrade the entire system to meet this requirement.

**F. Plenums:** Plenums for supply air distribution to administrative areas are not allowed.

## 6.1.15 Anterooms

**A. Specifications:** Anterooms are typically located between the laboratory/isolation/protected room and the corridor, between animal and non-animal areas, and between different containment levels. The anteroom has two sets of interlocking doors, one door to the laboratory/isolation/protected room and one door to the corridor or adjoining space. Depending on the type of isolation required, the anteroom may be positive, negative, or neutral pressure relative to the corridor. The use and type of anterooms shall be reviewed with the DTR and DOHS.

**B. Supply and Exhaust Air:** Anterooms shall be provided with both supply and exhaust air grilles. In addition, anterooms shall be provided with dedicated supply and exhaust air terminal units/boxes.

*Rationale: This permits the reconfiguration of the anteroom to accommodate program changes.*

**C. Room Pressure Differential:** Room differential pressure sensors shall be provided to monitor the pressure differential between the anteroom, the laboratory/isolation/protected room, the corridor or adjoining space. Room pressure differential is set to maintain a minimum of 2.5 Pa (0.01 in. w.g.). In some cases, room differential pressures may be as much as 12.5 Pa (0.05 in w.g.) or greater. Required room differential pressure shall be reviewed by the DTR and DOHS. See [Chapter 7: Building Automation Systems](#).

## 6.1.16 Program Equipment

**A. Equipment Selection:** The selection and use of “anticipated” program equipment such as microscopes, imaging systems (MRIs), nuclear magnetic resonance

equipment, refrigerators, freezers, centrifuges, autoclaves, glassware washers, BSCs, fume hoods, IVC (high density servers and computer equipment), program chillers and heat exchangers etc., shall be established early in the design phase.

**B. Standards:** Program equipment shall comply with National Fire Protection Association (NFPA), Occupational Safety and Health Administration (OSHA), American National Standards Institute (ANSI), National Sanitation Foundation (NSF), and NIH fume hoods specifications requirements and other applicable standards, including those listed in [Section 1.2 Referenced Codes, Standards, and Organizations](#). Equipment selected shall not contain asbestos, lead, or mercury.

**C. Equipment Requirements:** The A/E shall obtain equipment requirements so that heat rejection, electrical usage, operation usage, and other utility consumption data are included in the design of the HVAC systems. Equipment space requirements shall be closely reviewed; layouts shall allow for access to all piping, wiring, and ductwork connections for easy cleaning, maintenance, and repairs.

**D. Mechanical Systems:** Mechanical systems shall be designed and detailed so that they do not induce harm to or impede the operating efficiency of program equipment. Pressure regulators, safety relief valves, gravity drainage facilities, temperature controls, and backflow protection devices shall be provided for safe operation.

**E. Operation/Maintenance Strategy:** The building temperature control systems/building automation systems (BAS) should not be used to operate/control program equipment. The complete control and operation/maintenance strategy for program equipment shall be closely reviewed against program requirements and with program users.

### 6.1.16.1 Flammable Storage Cabinets

Flammable storage cabinets shall not be vented and shall not be located underneath fume hoods.

*Rationale: Flammable storage cabinets are tested unvented. Unless the manufacturer’s specific venting equipment is used, the cabinet’s fire resistance performance can be compromised.*



### 6.1.16.2 Corrosive Storage Cabinets

Ventilated corrosive storage cabinet(s) shall be provided in every laboratory where a chemical fume hood (CFH) is present or where corrosive chemicals are handled. The specifications for the cabinet(s) shall be based on the particular laboratory setup, as below:

- **If a CFH is present and only acids or bases are being used (not both):** Provide a ventilated corrosive storage cabinet for acids or bases beneath the CFH, vented to inside the CFH behind the baffle
- **If a CFH is not present and only acids or bases are being used (not both):** Provide a ventilated corrosive storage cabinet for acids or bases that is exhausted separately and connected to laboratory exhaust
- **If a CFH is present and both acids and bases are being used:** Provide a ventilated corrosive storage cabinet for acids beneath the CFH that is vented to inside the CFH behind the baffle, and provide a separate ventilated corrosive storage cabinet for bases that is exhausted separately and connected to laboratory exhaust
- **If a CFH is not present and both acids and bases are being used:** Provide two ventilated corrosive storage cabinets to separate acids and bases. This requires separate exhaust streams to avoid mixing of potentially incompatible vapors in the rare scenario where both acids and bases would be handled without a CFH present.

### 6.1.16.3 Biological Safety Cabinets

**A. Class II, Type A cabinets:** At the NIH, the BSCs are typically Class II, Type A1, or Type A2 (recirculated), which shall not be hard ducted to the building exhaust air system, nor shall thimble connections be used.

**B. Class II, Type B cabinets:** BSC, Class II-B1 (partially exhausted), and Class II-B2 (fully exhausted) may also be used in NIH facilities. The use of these cabinets are typically determined by the user and approved by the DOHS. These particular types of BSCs shall be hard ducted to a dedicated building exhaust air system. In addition, BSC Class II-B1 and Class II-B2 shall be factory provided with means of shutting down the BSCs internal fan whenever the static pressure in

the building exhaust air system connected to the BSC drops below the required set point. Building exhaust-air systems serving these BSCs shall include provisions for increasing the systems static pressure to compensate for loading of the exhaust HEPA filters within the BSC, i.e., variable frequency drives (VFDs). Exhaust HEPAs in BSCs require the exhaust system to maintain up to 625 Pa (2.5 in. w.g.) static pressure at the inlet of the ducted BSCs.

*Rationale: This is required to prevent the internal BSC fan from creating a positive pressure within the BSC and associated exhaust duct. A dedicated exhaust system allows the system to operate at higher inlet pressures at the BSC exhaust and reduces nuisance alarms.*

**C. Dedicated Exhaust-Type Air-Terminal Unit:** Whenever multiple BSCs of type B1 or B2 are connected to the same system, each BSC shall be provided with a dedicated exhaust-type air-terminal unit.

*Rationale: This will ensure the proper exhaust air amount is maintained through each BSC.*

**D. Exhaust Air Grille:** Rooms with ducted BSCs shall be provided with an additional room exhaust air grille connected to a dedicated room exhaust air terminal unit.

*Rationale: Whenever the manual isolation damper associated with the BSC is closed during the certification process of the BSC, the room ventilation system shall be automatically or manually adjusted to maintain the negative pressure in the laboratory.*

**E. HEPA Filtration:** Regardless of class and type, all BSCs at NIH shall be provided with BSC-mounted built-in HEPA filtration of the exhaust air prior to its discharge to the room space or to the outdoors. All Class II BSCs shall comply with Standard NSF-49 developed by the NSF.

**F. Use of BSCs in Projects:** Projects requiring the use of BSCs, regardless of class or type, shall be reviewed and approved by the DOHS and the DTR during the design phase of the project. Because of additional mechanical requirements to design and operate these cabinets, the



use of B1 or B2 cabinets should be carefully evaluated and avoided if at all possible. Class III gas-tight BSC provides highest protection level and are designed for highly infectious agents. Requirements for Class III BSCs are described in [Section 6.6: BSL-3 & ABSL-3 Biocontainment](#).

#### 6.1.16.4 Fume Hoods

**A. Requirements:** Fume hoods may be VAV or constant air volume (CV) type. Although the use of VAV hoods is highly recommended, the decision shall be based on a comprehensive life cycle cost analysis that accounts for all system features required by the NIH, taking into account existing building limitations. Fume hoods to be used in NIH facilities must meet the criteria as given in [Table 6.1.16.4 Fume Hood Designations](#). Constant volume fume hoods are typically “bypass” type.

**B. Testing Requirements:** Fume hoods shall comply with the testing requirements in the following NIH documents:

1. NIH Specification Section 15991 – On-Site Testing – Constant Volume Fume Hoods
2. NIH Specification Section 15992 – On-Site Testing – VAV Fume Hoods
3. Subpart C, “Fume Hood Testing and Alarm System” in [Appendix D: HVAC](#).

**Table 6.1.16.4 Fume Hood Designations**

Fume Hood	Type	Nominal Hood Width mm (in.)	NIH Specification Section
Vertical sash	Bench	1,200–1,800 (48–72)	11810
Horizontal sash	Bench	1,800 (72)	11820
Combination sash	Bench	1,800 (72)	11830

**C. Performance Ratings:** Fume hoods shall be evaluated as manufactured under the ANSI/ASHRAE Standard 110 and shall meet the following minimum performance ratings:

1. **Sash design position or positions:** 457 mm (18 in.)
2. **Average face velocity:** 0.51 m/s (100 fpm) ( $\pm 10\%$ )
3. **Range of face velocities:** No point in grid below 0.41 m/s (80 fpm) or above 0.61 m/s (120 fpm). Actual not as measured.
4. **Average face velocity for sash at 50%:** 0.41 (80) to 0.76 m/s (150 fpm)
5. **Average face velocity for sash at 25%:** 0.41 (80) to 1.52 m/s (300 fpm)
6. **Performance rating:** 0.05 ppm
7. **Sash movement performance rating:** 0.10 ppm
8. **Response time for VAV hoods:** Less than 3 seconds
9. **Percentage of auxiliary air supply:** 0% (auxiliary air hoods are not allowed)
10. **Static pressure loss:** Not more than 124 Pa (0.5 in. w.g.) at 0.51 m/s (100 fpm) face velocity.

#### 6.1.16.5 Variable Air Volume Fume Hoods

**A. Requirements:** VAV fume hoods used in NIH facilities shall be of the restricted bypass type and shall meet the following requirements:

1. Fume hoods shall meet current NIH fume hood specifications.
2. Fume hoods in non-containment-type laboratories shall have no air-cleaning (HEPA or charcoal), except for radiologic hoods.
3. The laboratory shall remain under negative pressure with respect to the corridor or adjoining rooms even when the fume hood operates at the minimum exhaust air rate. When the exhaust air quantity is reduced, supply air quantity shall be reduced by the same volume.
4. Laboratory minimum ventilation shall be provided even when the fume hood(s) operate in the minimum exhaust air-rate position.
5. Airflow monitoring/alarm devices shall be installed at each fume hood to provide the user

with operating information. These devices shall monitor the following: (1) face velocity at the sash opening, (2) sash position, and (3) pressure differential between hood and room.

6. The VAV hood sash shall not be operated automatically based on the proximity sensors.

**B. Resources:** Refer to the ORF Bioenvironmental Studies website: <http://orf.od.nih.gov/PoliciesAndGuidelines/Bioenvironmental/> for additional information and to the following articles:

1. “Methodology for Optimization of Laboratory Hood Containment – Volumes I and II”
2. “NIH Section 15991 – On-site Testing for Constant Volume Fume Hoods”
3. “NIH Section 15992 – On-site Testing for Variable Volume Fume Hoods”

#### 6.1.16.6 Low-Flow, Auxiliary Air, Radioisotope, Glove Boxes and Perchloric Acid Fume Hoods

**A. Testing Requirements:** Low-flow fume hoods may be used at the NIH as long as they meet all the requirements as outlined in the NIH/ASHRAE 110 Modified Fume Hood Testing Protocol. In addition, low flow fume hoods shall comply with the testing requirements of the listed NIH on-site testing specification sections 15991, 15992, and Subpart C, “Fume Hood Testing and Alarm System” in [Appendix D: HVAC](#). The face velocity of low flow hoods should never be below 0.41 m/s (80 fpm).

**B. Auxiliary Air-Type Fume Hoods:** Auxiliary air-type fume hoods shall not be used in any NIH facilities. In the event of a retrofit application, the A/E shall investigate the capacities of the existing system exclusive of the auxiliary air, and laboratory supply and exhaust system characteristics. Once it has been established that the system can support the addition or replacement of an existing fume hood, the PO shall be notified for approval before the design is allowed to proceed.

*Rationale: Auxiliary air systems use more energy than they are intended to save. They also impact the laboratory HVAC system’s ability to maintain stable temperature and humidity set points.*

**C. Radioisotope Hoods:** Radioisotope fume hoods are designed with internal surfaces impermeable to radioactive materials designed to support lead shielding. Ductwork connected to radioisotope hoods shall facilitate decontamination. HEPA and/or charcoal filters may be needed in exhaust ducts, consult with the Division of Radiation Safety (DRS). A completely sealed glove box may be used instead of a radioisotope fume hood where the amount of radioactive materials may exceed the inhalation exposure limit. Glove boxes shall be provided with ducted supply and exhaust, with the box itself kept at negative static pressure of 60 Pa (0.25 in. w.g.). The lab containing glove boxes shall be maintained at 12 Pa (0.05 in. w.g.) negative pressure. Consult with DRS.

**D. Perchloric Acid Hoods:** Perchloric acid hoods use highly oxidizing agents that form vapors that could cause potential explosion hazard. The exhaust system shall be equipped with a water wash down and drainage system and in conformance with *DRM* plumbing requirements. Ductwork shall be welded of 316 L stainless steel. DOHS should be consulted for new installations of perchloric acid hoods.

### 6.1.17 Environmental Rooms

**A. Types:** Controlled walk in environmental rooms could be constant temperature cold rooms or hot rooms. These rooms shall be located to accommodate service from outside the room space. Temperature and humidity readouts shall be located inside and outside the room. Ventilation of environmental rooms, which serve as occupied functioning laboratory spaces, shall be kept to a minimum particularly when close humidity control is required. Environmental rooms that are just used for storage shall not require ducted ventilation air. Storage environment rooms shall not be equipped with bench top or electrical outlets. Consider the use of environmental boxes as an alternative to walk in environmental rooms.

**B. Equipment:** Refrigeration systems shall be direct expansion (DX) type of industrial quality and designed to operate continuously. Controlled environmental rooms can be maintained to within 0.5°C (1°F) temperature and within 0.5% of full temperature and humidity span. A minimum of Proportional and Integrated

controllers shall be used with sensors rated of appropriate type and sensitivity. Cold rooms shall be provided with remote condensing units which are not located directly above the room. Floor-mounted condensing units are preferred. Associated air conditioning components shall be located to accommodate service from outside the room. Condensing units shall be water cooled. If air-cooled condensing units are used due to the lack of hydronic cooling media, then the indoor room temperature of the area surrounding the condenser shall not be allowed to exceed 6°C (10°F) above the temperature of occupied HVAC ventilating and dissipating heat accumulation caused by equipment condensers.

## 6.1.18 HVAC Design for Equipment Rooms

**A. Requirements:** Equipment rooms such as mechanical, electrical, boiler, chillers, pumps, AHUs, fans, autoclaves, and cage wash equipment, freezers, etc., shall be heated, ventilated, and conditioned as follows:

1. Mechanical rooms in general shall be designed to maintain temperature between 18°C (65°F) and 31°C (90°F).
2. Minimum ventilation rates shall comply with local building codes and good indoor air quality practices and requirements.
3. Laboratory exhaust systems shall not be used to ventilate mechanical spaces.
4. To the extent possible, sensitive equipment, such as vacuum pumps, air compressors, pure water production, etc., shall be located in a dedicated room where the temperature is to be maintained between 18°C (65°F) and 26°C (80°F). If a dedicated room is not feasible, localized cooling shall be provided.

**B. Electrical Rooms:** Electrical rooms shall be conditioned and/or ventilated to maintain a space temperature of no more than 26°C (80°F). Outdoor air into this room shall be filtered by Minimum Efficiency Reporting Value (MERV) 8 filters based on ASHRAE's Standard 52, Atmospheric Dust-Spot Test Efficiency. Transformer vaults and emergency generator rooms

shall be maintained between 18°C (65°F) and 40°C (104°F).

**C. Secondary Switchgear Rooms:** Secondary switchgear rooms shall be provided with heating and cooling equipment to maintain space temperature between 18°C (65°F) and 26°C (80°F) and humidity level below condensing to protect switchgear and electronic controls. Switchgear/transformer rooms located at the NIH Bethesda and Poolesville campuses shall be provided with temperature and humidity sensors. These sensors shall be connected to the existing Supervisory Control and Data Acquisition (SCADA) system, which is the energy monitoring system for the campus.

**D. Hydronic Piping:** Hydronic piping shall not be located within electrical rooms and secondary switchgear rooms. In the event that this cannot be avoided, protection shall be added such as monitored double containment piping or drip pans beneath all piping and equipment. These drip pans shall be provided with water-detection alarms connected to the BAS. Hydronic piping and drip pans shall never be located over any electrical transformer, electrical panels, or switchgear. Regardless of the method for mitigating potential leaks, the A/E shall submit justification for locating piping within electrical or switchgear rooms to ORF for approval.

**E. Boiler/Combustion Equipment Rooms:** Boiler rooms and rooms with combustion equipment shall be provided with a ventilation system that combines ventilation and combustion air requirements.

**F. Elevator Machine/Fire Alarm Rooms:** Elevator machine rooms, fire alarm rooms, and other similar spaces with electronic equipment shall be designed to be maintained between 18°C (65°F) and 24°C (78°F). These spaces will be provided with air conditioning served from an emergency power source. Cooling equipment and piping shall not be located above elevator machine equipment.

**G. Telecommunication Closets:** Telecommunication closets and other similar spaces with electronic equipment shall be designed to be maintained between 22°C (72°F) and 24°C (75°F). These spaces will be provided with air conditioning served from an emergency power source.

**H. Cylinder Storage Closets:** Ventilation of storage closets for cylinders of compressed gases shall be designed

per NFPA 55, and building and local codes. Ventilation air is typically exhausted from the closet and makeup air can be introduced from surrounding air. An exhaust fan serving this space from an emergency power source is required. Closets containing materials with explosion potential shall be carefully designed with all safety considerations. Refer to the NFPA 68 standard for explosion venting.

**I. Freezer Farm Rooms:** Freezer farm rooms must be designed to adequately reject heat produced by the freezers. The cooling system shall be redundant. The BAS system shall monitor and alarm room temperature.

## 6.1.19 Mechanical Equipment Location and Access

**A. Overlapping:** HVAC, electrical, and plumbing systems shall be zoned to avoid overlapping of multiple systems over multiple building zones.

*Rationale: This helps reduce building complexity during shutdowns, trouble shooting, and renovations.*

**B. Specific Building Zones:** HVAC systems shall be designed such that there are specific building zones for smoke and fire control, piping, ductwork, conduits, cable trays, and lighting. This is to include defined access and service areas/zones to all equipment. These areas/zones need to be particularly defined in mechanical rooms and interstitial spaces and additionally need to be identified in the construction documents.

**C. Service and Maintenance:** Systems shall be selected to minimize the number of mechanical components requiring service and maintenance.

**D. Ease of Access Location:** System components requiring frequent service and maintenance shall be located in equipment rooms or service areas and not above suspended ceilings or in occupied spaces and in particular not over sensitive equipment such as microscopes. Where this is unavoidable, at a minimum a secondary drain pan with leak sensor shall be provided, adequate space shall be provided around the units and if sufficient ceiling height is available, a permanent catwalk

shall be provided above the suspended ceiling.

**E. Access:** Clear and safe access shall be provided for servicing, removing, and replacing equipment.

**F. Sufficient Instrumentation:** Sufficient instrumentation shall be specified for monitoring, measuring, adjusting, controlling, and operating at part load as well as full load. See [Chapter 7: Building Automation Systems](#) for detailed requirements.

**G. Service Life Expectancy:** Equipment shall be selected and located for long term durability, reliability, maintainability, and serviceability to meet at a minimum the service life expectancy indicated by ASHRAE.

**H. Confined/Secured Spaces:** Equipment shall not be located in confined spaces, or with an access through secured spaces.

## 6.1.20 Heating Systems

**A. System Type:** Heating shall be provided by the use of steam and/or heating water systems. At the Bethesda campus, central plant steam is provided to each building.

**B. Electric Resistance Heating:** The use of electric resistance heating is prohibited. This includes built-in, small electric heaters.

### Exceptions:

1. Where steam or hot water is either unavailable or extending services is not cost-effective, a life cycle cost analysis shall be provided.
2. In generator/switch gear rooms.
3. Where small capacity silicone-controlled rectifier (SCR) electrical heating is required to maintain close temperature tolerances based on program use.

## 6.1.21 Cooling Systems

**A. System Type:** Cooling shall be provided by the use of chilled water/hydronic systems.

**B. DX Self-Contained Refrigeration Systems:** The use of DX air-cooled, self-contained refrigeration systems for cooling are not permitted.

**Exceptions:**

1. Where chilled water is not available in the building or is not within close proximity to the load. Life cycle cost analysis shall be provided.
2. Where required as backup for mission-critical computer rooms. The primary cooling shall be from chilled water.

**C. Equipment Cooling:** Equipment such as MRI, PET scanners, lasers, electron microscopes, etc., shall use building chilled water as the primary source for removing heat from equipment. Building chilled water is typically passed through a manufacturer-provided water-cooled heat exchanger and is hydraulically decoupled from the equipment. Certain sensitive equipment may utilize user provided air-cooled or water cooled chillers as primary source and building chilled water as backup. Back up chilled water shall be hydraulically decoupled from equipment loop.

**D. Variance Process:** Projects requiring the use of air-cooled equipment for cooling shall be submitted through the variance process and reviewed by the DTR during the early design phase of the project.

*Rationale: DX air-cooled equipment is energy inefficient, noisy, adds heat to the room if installed indoors, and requires more maintenance.*

## 6.1.22 Exhaust Air Systems

**A. Requirements:** Every exhaust air system is unique and requires specific review of issues such as air quantity, filtration, construction materials, type of discharge, controls, emergency power, hours of operation, etc. Exhaust air systems shall meet the following requirements:

1. General exhaust should follow the requirements in ASHRAE 62.1.
2. Exhaust air systems shall be designed to

operate 24 hours per day, 7 days a week.

3. Exhaust air systems shall be balanced with the AHU supply air systems.
4. Electric motors, drives, and bearings associated with exhaust fans serving laboratory and ARF shall be located out of the exhaust airstream.

*Rationale: This is to prevent maintenance personnel from exposure to potentially infectious agents or toxic chemicals or pathogens in the exhaust air stream.*

5. Electrical motors associated with laboratory and ARF exhaust fans shall be upsized by one motor size to allow for flexibility in future modifications.
6. Exhaust air fans and systems serving laboratory and ARF shall be connected to the emergency electrical power system.
7. Hazardous exhaust air ductwork shall not be located in the same shaft with supply air ductwork and return air ductwork per NFPA 90A.
8. Firestopping is required at penetrations, into the shaft. Refer to [Section 9.4 Life Safety Features](#).
9. Horizontal exhaust ducts passing through a fire barrier having a fire resistance rating of 2 hours or greater shall meet either of the following specifications:
  - a. Wrapped or encased with resistance rating equal to the fire barrier for 3 m (10 ft.) of duct on each side of the fire barrier including duct supports.
  - b. Constructed of materials having minimum fire-resistance rating equal to the fire barrier. Refer to NFPA 91, Standard for Exhaust Systems for Air Conveying of Vapors, Gases and Mist and Non- Combustible Particulate Solids, Section 4.1.12.
10. Fume hood exhaust shall not be combined with general exhaust.

*Exceptions: Where the exhaust streams are compatible and the DOHS has confirmed air stream*



compatibility. Under such conditions there are two options per NFPA 45 and NFPA 91:

- a. Fume hood exhaust and general exhaust may be combined only after penetrating the last fire partition on the floor or in the mechanical room or outdoors.
- b. Fume hood exhaust and general exhaust may be combined if the devices are served from the same laboratory unit.

11. Positive pressurized exhaust air ductwork should be avoided. Positive pressurized ductwork of laboratory exhaust air is prohibited in all occupied zones, including mechanical rooms.

**Rationale:** Any duct leakage of pressurized exhaust ductwork poses a contamination hazard.

**B. Flex Connections:** All flex connections at the inlet to the fan shall be fire-rated neoprene-coated glass fiber.

**C. Fume Hood Exhaust Ductwork/Fans:** Fume hood exhaust ductwork and exhaust fans shall be constructed of corrosion-resistant material, such as 316 L welded stainless steel, or be coated with a protective corrosion-resistant product such as epoxy phenolic or vinyl selected to resist the anticipated corrosive fumes.

**D. Exhaust Air Discharge/Stack:** Exhaust air discharge and stack shall be as per [Section 6.2.3 Outdoor Air Intakes and Exhaust Air Discharge](#).

**E. Dampers:** Smoke dampers and/or fire dampers shall not be installed in laboratory exhaust ducts serving fume hoods, BSCs, or other containment-type equipment.

**Rationale:** Normal or accidental closing of fire damper may cause explosion or impede removal of toxic, flammable, or combustible gases in case of a fire.

**F. Controls:** Where applicable, variable and CV exhaust air fans serving multiple spaces shall be equipped with VFDs for control of airflow and duct static pressure. Exhaust air from each laboratory and animal holding/support area shall be controlled by a dedicated pressure-independent air terminal air unit.

**G. Snorkel Exhaust Systems:** Snorkel exhaust systems used for local exhaust vents (LEV) or for heat extraction from equipment may be tied to the general laboratory exhaust system.

**H. Multiple VAV Fume Hoods:** Where multiple VAV fume hoods are manifolded to a single system, the A/E may reduce the equipment capacities of the exhaust system. This diversity factor is based on the usage of the VAV hoods and should be evaluated on a case-by-case basis in conjunction with the user and DOHS. The diversity factor shall not be less than 70%. Each hood in the manifold will be provided with individual air terminal unit for proper control and space tracking ability.

**Rationale:** Not all exhaust devices are used simultaneously at full capacity. There is potential to save capital and energy cost by reducing the size of the exhaust system.

### 6.1.22.1 Dedicated Exhaust Air Systems

**A. Dedicated Exhaust:** Research areas shall be provided with dedicated and separate exhaust air systems from non-research functions in the building. The following systems shall be provided with dedicated and separate/independent exhaust air systems from any other exhaust air systems in the building:

- Isolation rooms; multiple isolation rooms may be combined into a single exhaust air system
- Laboratory general research areas
- Fume hood exhaust unless complying with exceptions provided in previous section
- Ducted BSCs

**Rationale:** Ducted BSCs on an independent exhaust system precludes requiring the entire building exhaust system to be designed to the higher pressure. Dedicated exhaust also allows the ducted BSCs to operate without being subjected to frequent out-of-range alarms.

- Radioisotope/radioactive fume hoods
- Perchloric acid hoods
- General animal research areas



- Cage washers; in addition, certain cage wash equipment may require special space configuration. The A/E shall discuss these systems with the animal program personnel.
- Ductwork serving central sterilization processing areas
- Ductwork serving areas with ethylene oxide (EtO) sterilizers; EtO exhaust air systems shall meet the installation requirements set forth by U.S. Environmental Protection Agency (EPA). This system shall be provided with means of determining a failure of the exhaust air system and shutting down the EtO sterilizer.
- Ductwork serving spaces with battery-charging equipment
- Ductwork serving gas cylinders storage spaces
- Janitor's closets, locker rooms, and toilet exhaust air systems
- Any other function as designated by the DOHS
- NMR/MRI purge and quench

### 6.1.22.2 Exhaust Redundancy

Exhaust air systems shall be arranged with multiple manifolded fans designed to achieve  $N + 1$  redundancy and maintain the exhaust air system fully operational at all times. Each manifolded fan shall be designed to be fully isolated, while the overall system remains fully operational. The A/E shall review redundancy requirements for each particular system with the program user and the DOHS. Regardless of the system size, exhaust systems serving the following spaces and/or equipment shall be provided with an  $N + 1$  redundancy:

- Isolation rooms
- Laboratory general research areas
- Fume hood exhaust
- Radioisotope/radioactive fume hoods
- Animal general research areas
- Cage washers
- BSCs
- Perchloric Acid exhaust
- Any other function as designated by the DOHS

### 6.1.22.3 Animal Exhaust Air Systems

**A. Discharge Exhaust Air Outdoors:** For protection of personnel and to minimize the potential for cross-contamination of animals, exhaust air from animal rooms shall be discharged outdoors without recirculation into any other room. The direction of airflow shall be inward to the animal rooms at all times. Where protection of the animals from possible contamination is required, consider providing ventilated anterooms. The use of filtered isolation cages may also be considered. The A/E should consult with animal facility personnel with regard to the specific requirements for protection of animals.

**B. Cage Wash Facilities:** In cage wash facilities, the “dirty,” “clean,” and cage washing equipment, including associated mechanical supporting equipment area, shall be physically separated from each other, including equipment pits. Cage wash areas require dedicated exhaust systems to handle the large quantities of hot and moist air generated directly from the equipment or from the room.

### 6.1.22.4 Necropsy and Pathology

Necropsy and pathology work is considered potentially infectious. Within the ARFs, this work shall be done within BSCs or on downdraft tables. The use and the design of downdraft tables shall be approved by the DOHS. Downdraft tables shall provide an average downdraft of 0.25 m/s (50 fpm) at a height of 125 mm (5 in.) over the entire top surface of the table. (For detailed calculations on downdraft table particle capture efficiency, see [Appendix B: Downdraft Table Particle Capture Efficiency Calculation](#)).

### 6.1.22.5 Isolation Rooms Exhaust Air Systems

The exhaust air system for isolation rooms shall be a dedicated system capable of serving negative pressure (normal isolation) rooms or positive pressure (reverse isolation) rooms. Exhaust air systems for isolation rooms dealing with highly infectious pathogens may require bag-in/bag-out HEPA filtration. The A/E shall review filtration requirements for each particular system with the program user and the DOHS. Use of HEPA filter shall be approved by DOHS. If HEPA filtration is not required, the system shall be designed with provisions

for adding the HEPA filtration in the future. This dedicated exhaust air system shall include pressure-independent constant volume air terminal units, roof-mounted exhaust fans, VFD for filter loading and/or for multiple rooms applications, exhaust stacks, bag-in/bag-out HEPA filters, etc.

#### 6.1.22.6 Exhaust Air Filtration

Generally, exhaust air does not require filtration or scrubbing. However, in special laboratories, such as laboratories using radioisotopes or certain hazardous chemicals, the exhaust air may require special filtration before being discharged to the outdoors. The A/E shall consult with the DTR, DOHS, and DRS for specific requirements. These exhaust air systems shall include provisions for accounting for filter loading and adjusting the system static pressure to maintain the required airflow amount. Whenever filters or scrubbers are required, they shall be located as close to the source of contamination as possible while maintaining ready access for installation, monitoring, maintenance, testing, and filter replacement.

#### 6.1.22.7 Wet Exhaust

**A. Canopy Hoods:** Wet exhaust air from areas such as sterilizers, autoclaves, glass washers, cage washers, and warewashing equipment, etc., shall be captured by using canopy-type stainless steel hoods at each equipment entrance and exit. Canopy hoods shall meet the following requirements:

1. The canopy hood shall be located above the door to load and unload the equipment. In the case of double-sided equipment, a canopy shall be placed above each equipment door.
2. Exhaust air shall be at a minimum rate of 0.254 m/s (50 fpm) capture velocity at the face of the canopy hood.
3. Canopy hood design shall include a drip ledge to collect condensate steam. In large canopy hoods, collected condensate steam shall be piped to the nearest floor drain.
4. Wet exhaust systems shall be separated from other exhaust air systems.

5. Ductwork shall be pitched back toward the canopy hood. Provide duct drains and/or drip legs for low points in ductwork and exhaust risers. All ductwork shall be welded 316 L stainless steel and minimum 18 G.
6. Canopy exhaust hoods shall be installed above steam vapor- and heat-generating equipment in both the “dirty” and the “clean” sides of the equipment.

**B. Resources:** For additional information, refer to “Calculation Protocols for Canopy Hoods over Autoclaves: NIH Local Exhaust Ventilation (LEV) Test Protocol”, in [Appendix D: HVAC](#).

### 6.1.23 Energy Conservation, Efficiency, and Recovery

**A. Best Practices:** HVAC systems shall be designed and equipment selected using best practices to achieve optimal energy-efficiency and water conservation, without compromising the research program, safety, reliability, or the requirements within the *DRM*, code, and referenced standards. Approaches must be cost-effective, durable, holistically considered, and present a reasonable payback. Payback period of less than 10–15 years is typically considered reasonable. A life cycle cost analysis shall be provided.

***Rationale:** Energy and water conservation are federal mandates, and required of responsible design to maintain the safe and reliable operations of the facility. Approaches must be cost-effective over the life cycle of the facility and present a reasonable payback. Thoughtful consideration is required in reviewing sustainability approaches to ensure the solution is ultimately beneficial, energy-efficient, cost-effective, and does not compromise operations. The goal is to utilize justified practices that provide holistic benefits rather than achieving “points” in a scoring system.*

**B. Codes/Standards:** The A/E shall utilize the latest edition of the following energy codes and standards to design the exterior envelope for selecting HVAC and mechanical systems.

- ASHRAE Standard 90.1
- ASHRAE 189.1
- International Energy Conservation Code
- All applicable federal mandates, executive orders, codes, and standards for energy-efficiency and sustainable design

**C. Safety Requirements:** Efforts to reduce energy must not compromise any safety requirements. These systems must maintain the required environmental conditions at all times.

**D. Reduce Exhaust Airflow:** It is encouraged to use variable volume control of exhaust air through fume hoods by reducing exhaust airflow when the fume hood sash is not open.

*Rationale: Airflow control for VAV hoods must be integrated with the laboratory control system and its setting and operation must not jeopardize the safety and function of the laboratory.*

**E. Chilled Beams:** It is encouraged to use room-cooling hydronic HVAC systems such as chilled beams that decouple the room cooling function from the ventilation function and minimize reheat. Four-pipe (with both reheat water valve and chilled water valve) active chilled beams terminal units may be evaluated for laboratory facilities as an alternative to conventional VAV-reheat systems. A life cycle cost analysis shall be provided. Primary airflow is introduced to the chilled beam via a pressure-independent air terminal, which has the ability to track airflow offsets with the exhaust terminal in the space. Chilled beams provide sensible cooling to the space while latent load is handled by the primary air handler. The chilled beam water temperature must be actively maintained above room air dewpoint to prevent condensation. Appropriate dewpoint sensing and condensation monitoring methods shall be provided where chilled beams or other non-condensing hydronic cooling methods are used. An adequate number of chilled beams should be installed in the space for proper air distribution. Chilled beams are not suitable in spaces with high cooling loads or in high density fume hood labs, in spaces with high latent loads, in high containment areas or in animal rooms.

*Rationale: A HVAC design using chilled beams typically requires a smaller primary air handlers and distribution system as compared to the VAV reheat system. Hydronic room-cooling methods using chilled beams save considerable energy by reducing ventilation air, overall HVAC capacity, and reheat energy. Animal rooms have high density of particulate (hair, allergens, etc.) and chilled beam recirculating process may be compromised and require continuous cleaning.*

**F. Energy Recovery Systems:** Due to once through supply air systems employed in laboratories and ARFs, significant energy is lost as exhaust. The A/E shall utilize energy recovery systems for energy conservation, but these should be balanced against risk of cross-contamination from exhaust to supply stream. The risk for potential cross-contamination of chemical and biological materials from exhaust air to intake air and potential for corrosion and fouling of devices located in the exhaust airstream should be evaluated.

**G. Energy Recovery Costs:** When evaluating energy recovery costs, all costs (pumping, air pressure drops, etc.) on both sides of the equation should be evaluated. It is recommended that some level of degradation due to fouling be included in the calculation.

**H. Run-Around Coils:** Run-around coils are used to recover sensible heat from exhaust air steam to the outside airstream via coils and glycol piping and pumps. There is no risk of cross-contamination between exhaust and intake air. Combination heat recovery-preheat coils should be avoided due to complications in controlling and the possibility of overheating intake air in the summer. Roughing filters shall be used upstream of exhaust coil serving ARFs and corrosion protection should be applied in exhaust coils serving laboratories. Run-around coils are applied where supply and exhaust air handlers are separated by suitable distance.

**I. Energy-Recovery Wheels:** Energy-recovery enthalpy wheels recover total energy (sensible and latent) and are more efficient than sensible heat-recovery systems. They require supply and exhaust ductwork configured to be adjacent at the heat-recovery device. There is however potential for cross-contamination from exhaust to supply. Exhaust from fume hoods and chemical

storage rooms shall not be permitted to pass through an enthalpy-wheel system. Energy-recovery wheels for NIH facilities shall be evaluated based on programmatic use of the building, the analysis of the hazardous materials and chemicals planned to be used in the building, robustness of the wheel and the wheel assembly, the bearings and seal, cross-contamination limits, factory and field performance testing to verify allowable cross-contamination limits. All requests for energy recovery wheels must be submitted to the DTR for review early in the design.

**J. Load Data:** It is encouraged to use actual laboratory equipment load data as described under [Section 6.1.3 Heating and Cooling Load Calculations](#).

**K. Issues:** The PO shall be notified (with justification) when requirements of the energy conservation codes and standards cannot be satisfied due to program requirements. New construction or major renovation shall require complete HVAC and energy simulation modeling. Life cycle cost shall include capital cost factors for chillers and boilers as provided by the NIH as well as up-to-date energy costs.

services. Refer to [Section 1.15 Common Engineering Systems' Requirements](#) for additional information.

***Rationale:** Failures in HVAC systems can cause substantial impact to facility operations and loss of research. Although many catastrophic utility failures can be prevented or controlled by providing redundant equipment and appropriate standby power supplies, freeze protection measures, commissioning activities and BAS monitoring, these specific additional precautions should be addressed in the design of HVAC systems for research laboratories and ARFs along with an evaluation of additional risks in conjunction with the program. The rapid restoration of services and minimization of damage is critical in any emergency and is best accommodated through careful planning and installation of quality controls. Additional provisions may be found in the requirements for each system.*

---

## 6.1.24 Systems Failure and Disaster Mitigation

Systems shall be designed and materials selected to minimize potential for loss of service and to limit impact on laboratory research and ARF operations in the event of disaster or malfunction. Throughout the planning and design stages, the A/E shall evaluate each system to assess potential steps that may be taken to alleviate future damages, service disruptions, and promote rapid restoration of temporary and normal

# Exhibit 6.1

## Helium Quench Pipe Failure, Room Pressure Analysis Methodology

---

**Farhad Memarzadeh, Ph.D., P.E.**

Division of Technical Resources

Office of Research Facilities

National Institutes of Health

## Helium Quench Pipe Failure, Room Pressure Analysis Methodology

Farhad Memarzadeh, Ph.D., P.E.

Assuming the Helium tank capacity is  $M_{He,tank}$ , and the helium is released into the room within  $t_r$  seconds, the mass flow rate of Helium is therefore

$$m_{He} = \frac{M_{He,tank}}{t_r}$$

At any given moment  $t$  after the quench pipe failure, within a small time increment  $\Delta t$ , the mass of Helium in the room can be expressed as

$$M_{He,n+1} = M_{He,n} + m_{He}\Delta t - f_{He}m_{out}\Delta t$$

Similarly

$$M_{air,n+1} = M_{air,n} + m_{air}\Delta t - (1 - f_{He})m_{out}\Delta t$$

where,  $f_{He}$  is the mass fraction of Helium in the room air-helium mixture,

$$f_{He} = \frac{M_{He}}{M_{He} + M_{air}}$$

$m_{out}$  is the mass flow rate going out of the room, due to passive ventilation openings and door openings,  $m_{air}$  is the mass flow of air goes into the room, and since the room pressure is very high, normal HVAC supply can be assumed not functional, and this value should be set to 0.

The partial pressure of Helium and air at this moment should be

$$p_{He} = \frac{M_{He}}{V} R_{He}T$$

$$p_{air} = \frac{M_{air}}{V} R_{air}T$$

and total pressure in the room should be

$$p_{total} = p_{air} + p_{He}$$

where  $V$  is the room volume,  $R_{He}$ ,  $R_{air}$  are the Helium and air gas constant,  $T$  is the room temperature and is somewhat difficult to estimate. Given that the period of time is relatively short, one method to estimate is to assume only  $f_{mix}$  fraction of the Helium actually got a chance to mix fully with air, therefore



$$T_{n+1} = \frac{C_{p,air}M_{air}T_n + f_{mix} * C_{p,He}M_{He}T_{He}}{C_{p,air}M_{air} + C_{p,He}M_{He}}$$

this assumption is not as solid as others, and should be subject to reconsideration.

The mass flow rate going out the room can be evaluated as

$$m_{out} = \rho A \sqrt{\frac{2(\bar{p}_{total} - p_{atm})}{\rho f}}$$

since  $\bar{p}_{total}$  does change with time, we can numerically represent it as

$$\bar{p}_{total} = \frac{P_{total,n+1} + P_{total,n}}{2}$$

The sequence of the calculation is:

1. Given initial room condition,  $t=0$
2. Increase time step to  $t+\Delta t$
3. Calculate  $m_{He}, M_{He} \rightarrow p_{He} \rightarrow p_{air} \rightarrow p_{total} \rightarrow m_{out}$
4. If  $t$  has reached maximum calculation time, stop, otherwise return to step 2.

# Section 6.2

## Supply Air Handling Systems

---

### Contents

- 6.2.0 Introduction
- 6.2.1 Supply and Exhaust Air Handling Capacity
- 6.2.2 Ductwork Design
- 6.2.3 Outdoor Air Intakes and Exhaust Air Discharge
- 6.2.4 Air Handling Units
  - 6.2.4.1 Air Handling Systems for Administrative and General Use Facilities
  - 6.2.4.2 Air Handling Systems for Laboratory and Animal Research Facilities
  - 6.2.4.3 Air Handling Systems for Clinical Facilities
- 6.2.5 Air Filtration Systems
- 6.2.6 Humidification Systems
- 6.2.7 Fans
- 6.2.8 Motor and Variable Frequency Drives
  - 6.2.8.1 Motors
  - 6.2.8.2 Variable Frequency Drives
- 6.2.9 Emergency Electrical Power Generators
  - 6.2.9.1 Emergency Generator Room Ventilation
  - 6.2.9.2 Engine's Fuel Oil System
  - 6.2.9.3 Generator Set Noise and Selection of Silencer
  - 6.2.9.4 Generator Space Requirements
  - 6.2.9.5 Generator Fire Protection Requirements

## 6.2.0 Introduction

Air handling systems and associated components serving laboratory and animal research facilities spaces are critical to ensuring uninterrupted research and must be durable to ensure system performance over the life cycle of the equipment. This section applies to all types of NIH facilities, unless noted otherwise.

### 6.2.1 Supply and Exhaust Air Handling Capacity

**A. Labs/ARFs:** Supply air handlers and exhaust fans in laboratories and ARFs shall be sized to provide a 20% future requirement above design conditions to allow for changes in research and future growth. The 20% shall apply to fans, motors, dampers, cooling coils, heating coils, humidifiers, and filters.

Throughout this section, the term “design capacity” shall be understood to mean capacity to achieve the stated design conditions, exclusive of the 20% allowance for future growth. The term “Equipment capacity” shall be understood to mean “design capacity” plus 20% for future growth. The requirement shall apply to both new or renovation projects.

**B. Laboratory/ARF additional requirements:**

1. Supply and exhaust systems shall use dedicated, pressure-independent air-terminal devices.
2. Hot water reheat coils are required for the supply air terminals. Use of steam reheat coils is not allowed in animal rooms because of risk of overheating and wide fluctuations in room temperature.
3. At a minimum, makeup air and exhaust air system capacity for laboratories shall allow adequate airflow for at least one 1.2 m (4 ft.) wide vertical sash fume hood in every other laboratory module or as determined by user programming, whichever is greater.
4. Central systems may be supplemented by fan coil units (FCUs), chilled beams, radiant panels, etc. FCUs are not allowed in tissue culture

rooms and BSL-3 and ABSL-3 facilities. Chilled beams are not allowed in BSL-3 and ABSL-3 facilities.

**C. Administrative/General Use Facilities:** Supply air handlers, and return and exhaust fans for administrative and general use facilities shall be sized to provide a 10% allowance above design conditions to allow for future changes in space arrangement and future growth.

### 6.2.2 Ductwork Design

**A. Standards:** Ductwork systems shall be designed, fabricated, and installed in accordance with Table 6.2.2 (A) and (B) and with applicable ASHRAE and the Sheet Metal and Air Conditioning Contractor’s National Association (SMACNA) standards. Kitchen hood exhaust ductwork shall be constructed in accordance with NFPA 96 and the applicable SMACNA standards.

**B. Construction:** Ductwork may be single-wall or double-wall construction and may be round, flat oval, or rectangular in shape.

**C. Duct Lining:** Duct lining is not permitted for use in air handling equipment and duct systems.

*Rationale: Duct lining is not permitted due to the possibility of releasing insulation fibers into the airstream. Also, there is risk of mold and bacteria if the lining should become wet.*

**D. Flexible Ductwork:** Flexible ductwork may be used for branch duct connections in low-pressure supply- and air-transfer duct systems. Flexible-duct runs shall be limited to 1.8 m (6 ft). Flexible ducts shall have a UL rated velocity of at least 20.3 m/s (4,000 fpm) and a UL rated positive pressure of 2.5 kPa (10 in. w.g.). Flexible ducts shall be factory insulated and comply with the latest NFPA Standards 90A and 90B. Flexible duct connections shall be made using stainless steel draw bands. Flexible ducts shall be installed to prevent restriction of air and with no more than 5% of compression, since flexible duct pressure drops increase substantially when compressed. Flexible duct shall not be used in exhaust, return, or other negative pressure duct systems due to risk of collapse or excess restriction of airflow.

1. **Duct Velocities:** Refer to [Table 6.2.2 \(A\) Acceptable Maximum Air Velocities in the Design and Sizing of HVAC Components](#) for a list of acceptable air velocities to be used in the design and sizing of different HVAC components.
2. **Minimum Duct Construction Standards:** Refer to [Table 6.2.2 \(B\) Minimum Duct Construction Standards](#) for a list of the minimum ductwork construction requirements.
3. **Duct Leakage Testing:** Construction documents shall require the sheet metal contractor to conduct pressure tests of the installed ductwork to quantify the leakage rate of the installed systems.
  - a. All medium pressure and high pressure ductwork shall be tested at rated pressure class.
  - b. Medium and high pressure galvanized ductwork shall meet the SMACNA leakage class 4 for rectangular duct and class 3 for round duct.
  - c. Fume hood, biological safety cabinet and stainless steel welded exhaust duct shall be tested to leakage not exceeding 0.5 cfm per 100 ft<sup>2</sup> of the duct surface area.
  - d. All non-welded stainless steel hazardous duct shall be tested to leakage not exceeding 2 cfm per 100 ft<sup>2</sup> of the duct surface area.
4. **Ductwork Penetrations:** All ductwork penetrating room walls (above the ceiling) and all diffuser/register/grille penetrating hard ceilings shall be sealed. See [Appendix L: Sealant Table](#).
5. **Casing and Plenums:** Casings and plenums are used to house filters, coils and automatic dampers at the air handling systems. Casings shall be constructed of minimum of 1.316 mm (18G) galvanized double skin insulated panel access doors.

***Rationale:** Pressure testing of ductwork ensures unwanted leaks into surrounding areas are minimized and the airflow and energy cost to operate the system is not wasted.*

**Table 6.2.2 (A) Acceptable Maximum Air Velocities in the Design and Sizing of HVAC Components**

Element/System	Maximum Face Velocity m/s (fpm)
<b>Ductwork</b>	
Up to 500 Pa (2 in. w.g.) pressure class in mechanical shafts	7.6 (1,500)
Ductwork above occupied areas	6.1 (1,200)
Air outlet devices	3.8 (750)
750 Pa (3 in. w.g.) to 1,000 Pa (4 in. w.g.) pressure class in mechanical shafts	12.7 (2,500)
Ductwork above occupied areas	10.2 (2,000)
Outdoor/relief air	7.6 (1,500)
Animal research facility exhaust ductwork	7.6 (1,500)
<b>Coils</b>	
Cooling/dehumidifying coils ≤ 2,000 cfm	2.3 (450)
Cooling/dehumidifying coils > 2,000 cfm	2.1–2.5 (420–500)
Heating coils—hot water	2.5–3.8 (500–750)
<b>Filters</b>	
Panel type—low efficiency	4.0 (800)
Pleated panel type—low to medium efficiency	2.5 (500)
Bag-type, rigid box type—medium to high efficiency	2.5 (500)
HEPA in duct, air handler	1.3 (250)
HEPA terminal	0.5 (100)
<b>Louvers<sup>a</sup></b>	
Intake	2.5 (500)
Exhaust	3.8 (750)

<sup>a</sup>Air intake louvers shall be sized to not exceed the rating of the louver and avoid water penetration.

**Table 6.2.2 (B) Minimum Duct Construction Standards**

Application	SMACNA Pressure Class <sup>a</sup> Pa (in. w.g.)	Ductwork Materials
All ductwork, unless noted otherwise	500 (2)	G90 galv.
Outdoor air intake, relief, return, and general exhaust air plenums <sup>b,c,d</sup>	500 (2)	G90 galv.
Low-pressure supply air and return air ductwork, constant volume <sup>c,d</sup>	500 (2)	G90 galv.
Low-pressure supply air ductwork downstream of air terminal units <sup>b,c,d</sup>	500 (2)	G90 galv.
Low-pressure return air ductwork upstream of air terminal units <sup>b,c,d</sup>	500 (2)	G90 galv.
Low-pressure general exhaust air ductwork <sup>c,d</sup>	500 (2)	G90 galv.
Low-pressure wet exhaust air ductwork	500 (2)	SS (welded)
Low-pressure hazardous exhaust air ductwork upstream of air terminal units <sup>e,f</sup>	500 (2)	SS
Medium-pressure supply air ductwork upstream of air terminal units, VAV, or CV air terminal units <sup>g,d</sup>	1,000 (4)	G90 galv.
Medium-pressure general exhaust air ductwork downstream of air terminal units, VAV, or CV air terminal units <sup>g</sup>	1,000 (4)	G90 galv.
Medium-pressure hazardous exhaust air ductwork downstream of air terminal units, VAV or CV, duct operating pressure up to 750 Pa (3 in. w.g.) <sup>e,g,f</sup>	1,000 (4)	SS
High-pressure hazardous exhaust air ductwork downstream of air terminal units, VAV or CV air terminal units, duct operating pressure above 750 Pa (3 in. w.g.) to 1,250 Pa (5 in. w.g.) operating pressures <sup>e,h,f</sup>	Class I/industrial 1,500 (6)	SS
Hazardous exhaust air, positive pressure segment up to 1,250 Pa (5 in. w.g.) operating pressure <sup>e,f</sup>	Class I/industrial 1,500 (6)	SS (welded)
Special hazard exhaust air ductwork <sup>g,i</sup>	1,000 (4)	SS
Kitchen Hood Exhaust	1,000 (4)	SS (welded)
MRI room	As specified	Alum

**Abbreviations:** VAV = variable air volume; CV = constant air volume; SS = stainless steel <sup>f</sup>All longitudinal seams on hazardous exhaust ductwork shall be welded.

<sup>a</sup>This is the minimum SMACNA pressure classification to be used for the construction of ductwork and associated components in the listed application. Duct construction shall be as listed but no less than 250 kPa (1 in. w.g.) higher than the calculated operating static pressure, including future capacity, for the given section of ductwork, whichever is greater. <sup>g</sup>Air risers serving multiple floors need to be constructed to meet at least SMACNA 1,500 Pa (6 in. w.g.) duct construction.

<sup>b</sup>Plenums need to be constructed of minimum 1.316 mm (18 G) G90 galvanized steel. These panels need to be insulated.

<sup>c</sup>Ductwork leak testing for this application is not required.

<sup>d</sup>All ductwork shall be constructed to minimum of SMACNA Seal class A.

<sup>e</sup>The term “hazard exhaust” generally applies to fume hood exhaust, BSC, down draft tables, etc. This includes vivarium exhaust ductwork from devices to terminal unit since the ductwork is subject to routine decontamination. All hazard ducts shall be constructed of 316L SS (18 minimum).

<sup>h</sup>Air risers serving multiple floors need to be constructed to meet at least SMACNA 2,500 Pa (10 in. w.g.) duct construction.

<sup>i</sup>The term “special hazard exhaust” generally applies to exhaust air systems serving containment areas such as BSL-3 and ABSL-3 laboratories, radioactive hoods, perchloric acid hoods etc., which, by their critical nature or extreme hazard, shall be exhausted individually and typically require routine decontamination. Ductwork serving containment areas such as BSL-3 and ABSL-3 shall be 18 G minimum welded stainless steel. All special hazard ducts shall be constructed of 316 SS welded.

<sup>f</sup>Duct joints shall be welded construction, one standard gage heavier than for the same galvanized.

### 6.2.3 Outdoor Air Intakes and Exhaust Air Discharge

**A. Intakes/Outlets:** Outdoor air intakes shall be at least 12 m (40 ft.) away from any of the exhaust-contaminant sources (all types of exhaust fans including animal room exhaust and lab exhaust, vehicle exhaust, loading docks, automobile entrances, driveways, passenger drop-offs, cooling towers, boiler or incinerator stacks, emergency generators exhaust, vacuum pump exhaust, steam relief vents or other hot vents, plumbing vents, vents from steam condensate pumps units, kitchen hoods, refrigerant relief vents, mechanical/electrical room ventilation systems, etc.) regardless of discharging upward, horizontally, or deflected downward. Other factors such as wind direction, wind velocity, stack effect, system size, height of building(s), snow drift, and security concerns shall be evaluated, and location of intakes and outlets adjusted accordantly.

**B. Outdoor Air Intakes Location:** The bottom of all outdoor air intakes shall be located as high as practical, but not less than 3.6 m (12 ft.) above ground level and any adjacent building or site element within a horizontal distance of 4 m (13 ft.) from the air intake. Security requirements for location of air intakes shall be coordinated with DPSM (Security Management) through the PO. See [Section 1.13 Security Requirements and Procedures](#) of the *DRM*.

**C. Lab and ARF Exhaust:** Design of lab and ARF exhaust shall consider stack height and discharge air velocity characteristics to overcome the building cavity boundary and avoid re-entrainment of exhaust. Stacks shall be shown as part of the architectural design. In general, exhaust stacks shall be designed to meet the following requirements:

1. Safety concerns shall always take precedence over aesthetics.
2. Discharge shall be a minimum of 3 m (10 ft.) above the roofline and any roof element within a horizontal distance of a 4 m (13 ft.) radius.
3. Upward velocity shall be a minimum of 15 m/s (3,000 fpm) at the point of discharge. Reentry calculations may dictate higher discharge velocities.
4. Manifolded exhaust fans shall have separate

exhaust stacks for each fan to avoid positively pressurizing through a non-operating exhaust fan.

**Exception:** *Where two fans are required to operate simultaneously at 50% capacity (to allow continuous operation without gaps in operation while transferring), a common discharge stack is permitted to minimize discharge pressure loss through each stack and reduce noise, while maintaining the minimum 15 m/s (3,000 fpm) stack velocity. Motorized discharge dampers are required in suction and discharge of each fan.*

**D. Air Dispersion Modeling:** An air dispersion model shall be provided in addition to the geometric method (string distance between exhaust stack and nearby receptor) for calculating the minimum separation distance between intake and exhaust air. See [Appendix D](#) for a computational analysis in evaluating building external airflows as influenced by new and existing obstacles.

**Rationale:** *The geometric method is inadequate for exhaust streams containing toxic or odorous materials because it does not factor in the wind direction, wind speed, and the concentration of air at air intakes.*

## 6.2.4 Air Handling Units

The BOD shall define the type and quality of air handling equipment proposed.

### 6.2.4.1 Air Handling Systems for Administrative and General Use Facilities

**A. System Type:** Air handling systems for administration, office type, conference, and other general use facilities frequently employ variable air volume (VAV) with terminal units with and without reheat as applicable. These systems are a recirculating type with ventilation rates designed to meet the latest ASHRAE Standards 62 and 90.1 or International Mechanical Code IMC. Airside dry-bulb economizers provide free cooling when ambient conditions permit.

**B. Features:** Air handling systems for administration/office type buildings are best kept simple and zoned



consistent with building use and occupancy schedules. Large conference rooms or assembly areas with intermittent use should not be connected to units that supply routine office space. Air handling systems found in these buildings may have the following features:

1. Single supply and return fans without redundant components
2. Night setback and morning warm-up control modes
3. Mixing plenums with minimum and maximum outdoor air dampers to accommodate minimum ventilation and economizer operations
4. Minimum Efficiency Reporting Value (MERV) 8 efficient prefilters and MERV 13 efficient after-filters
5. Preheat coils required to support morning warm-up functions
6. Draw-through chilled water coils
7. Central Air Handling Unit (AHU) humidifiers only
8. 750–1,000 Pa (3–4 in. w.g.) pressure duct distribution to terminal control devices
9. Fully ducted return-air system with building pressure-controlled relief devices
10. Units shall be factory packaged and commercial grade
11. Casing shall be double-wall construction for all sections of the entire unit with a minimum of 50 mm (2 in.) thick insulated panel for indoor units
12. Outdoor units shall be a minimum of 80 mm (3 in.) thick insulated panels. Outdoor units shall have the exterior panels painted to pass a 1,000 hour salt spray per ASTM B-117
13. Stainless steel drain pans shall be provided under the cooling coil
14. Design cooling coil velocity shall not exceed 2.5 m/s (500 fpm)
15. All unit sections shall have access doors to permit inspection and service of all components
16. Units shall have offset coil pipe headers to allow individual coils to slide out of unit casings
17. Units with capacity greater than 20,000 CFM shall be fully tested at the factory before shipping. Testing shall verify capacity and leakage rate. Unit casings shall be pressure rated for the total system design operating pressure plus 25%.

#### 6.2.4.2 Air Handling Systems for Laboratory and Animal Research Facilities

**A. Requirements:** Refer to [Section 6.1 Heating, Ventilation, and Air Conditioning Design](#) and this section. The following requirements apply to all AHUs to be used in NIH laboratories and ARFs:

1. Indoor-unit casings shall be double-wall construction for all sections of the entire AHU. Wall construction shall provide a minimum of 75 mm (3 in.) thick and have a minimum R-17 value. The exterior and interior wall panel shall be solid G90 galvanized steel or aluminum. All exterior and interior wall panels shall be 1.316 mm (18 G) solid G90 galvanized steel minimum, or 0.127 mm (0.05 in.) thick aluminum minimum. Cooling coil and humidifier sections shall be constructed of stainless steel interior panels for galvanized units. The unit roof and floor gauge (or thickness) shall be one gauge (or thickness) higher than wall to handle weight of personnel. The unit floor shall be a minimum of 4.7 mm (3/16 in.) aluminum plate with diamond tread, all welded construction. Panel construction shall allow the replacement of individual panel sections without disturbing adjacent panels.
2. Outdoor units shall be of double-wall construction with a minimum of R-19 insulation. Outdoor units shall have the exterior panels painted with a minimum of a 3-step paint process to pass a 1,000 hour salt spray per ASTM B-117.
3. Units shall be custom factory fabricated and custom field erected. Units shall be preassembled and fully tested at the factory before shipping. Units should be shipped as one piece

- if possible, or in as few sections as possible to limit the number of field-casing joints.
4. Unit casings shall be pressure rated at maximum operating pressure plus 50% or 2,500 Pa (10 in. w.g.), whichever is less. After installation, these units shall be field-tested.
  5. Field-erected AHUs may be used on large capacity applications and for installation in existing buildings where access is restricted or designed for new buildings where the construction phasing does not permit the installation of large factory-packaged or fabricated sections.
  6. Casing construction shall include full thermal breaks between exterior panels and interior panels.
  7. Casing construction shall be water and airtight. The fully assembled unit shall have a maximum air leakage rate of 0.5% of the supply air volume at the prescribed test pressure indicated in item (4) above. The unit deflection shall be L/240 at the prescribed test pressure. All factory and field penetrations shall be completely sealed and shall not reduce the leakage rating of the casing. This includes all casing penetrations within the unit and between unit's components. All penetrations for components such as electrical lighting, controls, etc., shall be sleeved and caulked to prevent leakage and condensation damage. This shall also apply to heat-recovery units.
  8. Access doors shall be provided on both sides of each equipment section. Doors shall be man-sized and a minimum of 600 mm (24 in.) wide. Each door shall be provided with a vision panel no less than 300 mm (12 in.) × 300 mm (12 in.). Door swing shall help seal the access door with the unit's internal air pressure.
  9. Lights shall be waterproof, marine type, and provided in all sections of the unit which are more than 1.4 m (54 in.) high. Lights shall be controlled from a single pilot switch located adjacent to one of the access doors.
  10. Air filters may consist of cartridge-type elements; roll filters are not acceptable. The design face velocity shall not exceed 2.5 m/s (500 fpm) nor shall manufacturers' standard nominal ratings be exceeded. The preferred filter face section dimensions are 600 mm (24 in.) × 600 mm (24 in.). Prefilters shall be utilized. All filter banks shall have intermediate supports to prevent bank deflection at maximum design pressure differentials. Minimum MERV 8 efficient filters shall be installed upstream of any heat recovery device.
  11. A manual magnehelic pressure gauge shall be provided on the unit's exterior at each filter section. One gauge shall be provided for each filter bank. The BAS shall also monitor the differential pressure across the filter.
  12. Air-handler coil tubing shall be of nominal 0.90 mm (0.035 in.) copper tubes with aluminum fins of at least 0.24 mm (0.0095 in.) thickness. Cooling coils shall be no more than 8 rows deep and 12 fins/in. to enhance cleaning and heat transfer. Where cooling cannot be achieved with a single coil, dual coils in series shall be provided. Galvanized coil frame and casings shall be provided for heating coils and stainless steel frame and casings for cooling coils. The use of turbulators is not acceptable.
  13. A cooling coil's air face velocity shall be sized for a nominal air face velocity not to exceed 2.14 m/s (420 fpm) for the present design conditions and 2.55 m/s (500 fpm) for the future growth capacity. Provide a plenum section downstream of coil with sufficient length to capture all the moisture carryover from coils before it reaches the next AHU component.
  14. Maximum size for individual coils shall be 3.0 m (10 ft.) long × 0.91 m (3 ft.) high. If larger coils are required, then multiple coils shall be provided.
  15. Multiple coils shall be valved separately so that if any individual coil fails, it can be isolated and drained while the remaining coils stay in operation. Coils shall be installed to allow the removal of individual coils without disturbing pipe headers or anything else that would prevent the remaining coils from operating. Coils shall be removable without major rigging. Coils that are split along the finned length in

- a number of small sections to accommodate space restraints are not allowed.
16. Steam coils shall be either steam distributing, non-freeze type with inner and outer tubes or integral face and bypass damper type.
  17. Return header for multiple-stacked coils shall be piped in a reverse-return configuration to assist with the balancing of the water flow. Strainers shall be provided on the feed line for each coil bank. Control and balancing valves shall be installed on the return line. Each coil shall be provided with a balancing valve with integral memory stop. Combination balancing, shut-off, and flow-meter devices are not acceptable.
  18. Each AHU section shall be provided with drains that permit the internal wash down of the unit in the event of a coil failure.
  19. Drain pans shall be provided for each cooling coil. Intermediate stainless steel drain pans shall be provided for each coil bank that is more than one coil high. Drain pans shall extend a minimum of 300 mm (12 in.) downstream of the cooling coils. The drain pan shall be stainless steel with a positive slope to a bottom drain connection. Pan drains shall be properly trapped. Static pressure conditions accounting for dirty filter(s) at fully loaded (100%) condition shall be used to calculate the trap height.
  20. Moisture eliminators may be considered where carryover presents a problem. However, eliminators shall not impede service access for cleaning of the coil-face surface.
  21. Fans may be vane-axial, airfoil centrifugal (single or double width), or plenum as justified by life cycle cost analysis. All fans shall be of a minimum construction Class II as per the Air Movement and Control Association (AMCA). Fans shall be totally isolated from the unit by the use of inertia bases and spring isolation. Fan-volume control shall be achieved by using variable frequency drives (VFDs) on centrifugal and plenum fans. Fans shall be arranged in the draw-through position. Blow-through configurations are not allowed.
  22. Direct drive small-plug fans (commonly called a “fan wall”) arranged in an array may be used to replace a traditional single large fan where space is limited. Each fan shall be provided with an isolation damper so air does not short circuit the non-working fan. Direct fan motors operating with VFDs shall not operate at higher than 90 Hz frequency and motor size shall be based on the operating frequency. Units operating with direct-drive fans should be carefully selected so the operating speed during VFD bypass mode does not exceed the maximum allowed fan rpm of the selected fan.
  23. Fans shall be vibration-isolated from the remaining parts of the unit and the connecting ductwork system.
  24. Fan shafts shall be solid and precision ground and polished.
  25. Fan bearings shall be selected based on a minimum life of  $L_{10}$  200,000 hours.
  26. When space limitations dictate that fans be placed in close proximity of heating or cooling coils, the distance between the fan inlet and the coil shall be a minimum of a wheel diameter for single-width fans and 1.5 wheel diameter for double-width fans.
  27. Sound attenuators may be necessary to meet the room sound criteria for the room served by the AHU. When feasible, they shall be integrated as a part of the AHU. Sound attenuators shall be packless type. The silencer rating shall be certified in accordance with ASTM E-477.
  28. Control dampers shall be low-leakage opposed blade for modulation control and parallel blade for open-closed operation or for mixing. Ultralow leakage, industrial-quality isolation dampers shall be installed at the discharge of manifolded systems. Sufficient space should be provided to remove and install actuators without the need for removal of dampers or other equipment.
  29. Fan airflow measurement in or near the fan inlet should not impede airflow.

30. Unit louvers are typically used for outdoor-air intakes. Louvers shall be AMCA rated and selected for low-pressure drop with less than 0.003 kg/m<sup>2</sup> (0.001 lb./ft<sup>2</sup>) penetration at 3.8 m/s (750 fpm) free-area velocity. Louvers shall be drainable and be constructed of anodized aluminum or stainless steel with 304 stainless steel hardware and bird screen.
31. Heat recovery may be considered as demonstrated by the life cycle analysis. The heating and cooling coils shall be designed and sized to function at full load without the energy-recovery system. Units with heat-recovery systems shall be designed such that devices could be out of commission without any interruption to AHU system operation.
32. Contract documents shall fully detail the size, dimensions, and specific component configuration of each factory-fabricated AHU, including all components, capacity of all components, all controls components, all sequences of operation, access areas, access doors, casing openings, service clearances, and overall dimensions. Layouts shall include sections to define the overall height and vertical location of duct connections, dampers, and louvers.
33. The PO shall determine if a NIH representative will witness the factory-testing of AHUs.

*Rationale: AHU requirements are predicated upon AHUs having a service life much longer than traditional commercial units.*

### 6.2.4.3 Air Handling Systems for Clinical Facilities

AHUs designed for clinical facilities shall be similar to air handlers used in NIH laboratories and ARFs, except these units are typically provided with return fans with an economizer system. The air handlers are provided with a second filter bank downstream of the fan. Consideration should be given to ensure the final filter is not too close to the fan resulting in uneven air distribution across the filter and potential wetting of the filter from upstream cooling or a humidifier.

## 6.2.5 Air Filtration Systems

**A. Required Filters:** Air filtration shall be provided to all supply air used to provide heating and air conditioning for laboratories and ARFs. Air filters shall be fully accessible to allow testing while system is fully operational at design load. As a minimum, supply air shall pass through a pre-filter and final filter on the upstream side of heating and cooling coils. Filter average efficiencies shall be MERV 8 (30%) for a pre-filter and MERV 14 (95%) for a final filter, based on ASHRAE Standard 52.2. HVAC air systems shall automatically adjust fan speed to compensate for the additional system static pressure produced by filter loading.

**B. Final Filtration:** Final filtration shall be provided downstream of supply air fans serving ARFs to protect against particulate and other containments possibly generated by the air handling equipment or from external sources. Average efficiency of the final filters shall be from MERV 14 to 17 (95% to 99.99%), based on ASHRAE Standard 52.2. Where final filters are used downstream of supply fans, the efficiency of the upstream filters may be reduced to MERV 13 instead of 14. Operating rooms for animal surgery shall be HEPA filtered. The A/E shall review the project's program requirements to establish specific filtration criteria and confirm with the DTR and DOHS.

**C. Clinical Facilities:** Supply air for clinical facilities shall pass through prefilters and final filters at the AHU. Filter average efficiencies shall be MERV 8 (30%) for prefilters and MERV 14–15 (95%) for final filters based on ASHRAE Standard 52.2. HEPA filtration (MERV 17 and above) is required for operating rooms or patient protective environment (PE) rooms. The A/E shall consult with the DOHS and DTR prior to the design of HEPA filters in the system.

**D. Fan-Filter Units:** Fan-filter units (FFU) are self-contained filter assembly units with fan, prefilters, shallow HEPA filter, and speed controls. FFUs are not recommended unless the duct system is incapable of providing the additional pressure drop required to overcome filter pressure drop of a HEPA filter. FFUs have a higher first cost, require additional service and maintenance and generate higher room noise, especially when multiple units are installed in the same room.

**E. HEPA Filters:** Where HEPA filters are used, they should be designed for a maximum of 1.52 m/s (300

fpm) in ducts or air handlers. Ceiling mounted terminal units shall be a maximum of 0.46 m/s (90 fpm), although higher velocities may be allowed depending on the application. All HEPA filtered systems shall incorporate periodic in situ testing of filters, gaskets and housing to assure there are no leaks in the HEPA filtration system. Ceiling-mounted HEPA filters shall be replaced from room side to minimize contamination.

---

## 6.2.6 Humidification Systems

**A. Humidification:** Humidification shall be provided where required to maintain space relative humidity requirements. In the Bethesda campus, steam from the central plant shall be utilized for this purpose. In other NIH locations, the A/E shall verify suitability of using plant steam with the PO during the design stage. At the NIH Bethesda campus clean steam for humidification is not required for most laboratory and animal research facilities as the chemical additives (amines) introduced in plant steam (for corrosion protection) remain below the air exposure threshold limit level per OSHA, American Conference of Industrial Hygienists (ACGIH), and FDA guidelines.

**B. Steam Injection Humidifier:** Humidifiers shall be the steam-separator type with jacketed steam injection which does not require a drain from the steam manifold. They may be located within AHUs or installed in the supply air ductwork. When located in the AHU, the humidifier section shall be located upstream of the cooling coil section (humidifier should be off in summer) to ensure the efficient distribution and absorption of vapor into the airstream. Connections should be piped to the exterior of the unit casing.

**C. Duct Mounted Humidifier:** A duct-mounted steam-distribution manifold shall be installed within a fully welded stainless steel ductwork section. The stainless steel section shall extend 0.6 m (2 ft.) upstream of the manifold and at least 2 m (6 ft.) downstream from the manifold. The downstream length may need to be extended depending on the absorption distance for the particular system design. Stainless steel ductwork shall be pitched and connected to a drain.

**D. Humidifier Piping and Controls:** Steam piping to the humidifier shall be low pressure and include a manual isolation valve for equipment isolation during service.

Humidifier controls shall include an automatic isolation valve to remain closed during cooling mode. Humidifier controls shall also include a high limit humidistat located downstream of the humidifier manifold.

**E. Panel Distribution Humidifier:** Panel distribution type humidifier may be installed in AHU's or ducts where absorption distance is very small, 500 mm (30 in.) or less. Panel type shall be multi-tube, stainless steel construction, for use with pressurized steam, and installed with sufficient trap height to drain the condensate to the building return. Jacketed steam humidifiers are preferred over steam dispersion type due to lower first cost and increased reliability.

**F. Adiabatic Humidifiers:** Adiabatic humidifiers shall not be used for humidification in laboratories, ARFs, or administrative facilities. Adiabatic humidifiers are not allowed in clinical facilities per ASHRAE 170. Steam is sterile and therefore eliminates risk of introducing viable microorganisms in the airstream. Ultrasonic humidifiers shall not be used because of the risk of aerosolized fine particles depositing in the lungs.

**G. Clean Steam Humidification:** Clean steam for humidification shall be provided for special areas such as transgenic animal housing and barrier (specific-pathogen free) housing. Transgenic animals are typically housed separately from the rest of the population in a higher degree sterile environment and may be susceptible to the chemical additives in plant steam. Clean steam for humidification may also be provided for cleanroom facilities and other areas required by the program. The A/E shall consult with the user, the DOHS, and the DTR to confirm the use of clean steam.

---

## 6.2.7 Fans

**A. Multiple Zones:** Variable and constant air volume (VAV and CV) centrifugal and plenum fans serving multiple zones shall be equipped with VFDs for control of volumetric flow rate and duct static pressure.

**B. Identical Fans:** All fans on a manifold or in parallel configuration shall be identical and have identical isolation dampers and volume/pressure controls.

**C. Accessibility:** All fans shall be constructed to meet a minimum Class II rating. They shall be fully accessible



for inspection, service, and routine maintenance. Fan bearings, where possible, shall be serviceable from outside hazardous or contaminated exhaust airstreams. In-line fans or plenum type fans with motors or drives exposed to exhaust airstreams serving laboratories and ARFs are not permitted.

***Rationale:** The purpose of requiring motors out of the airstream is to minimize exposure of maintenance staff to allergens, toxins, or contaminants that may be present in the exhaust air stream.*

**D. Certified Sound and Air Rating:** Fans shall have a certified sound and air rating based on tests performed in accordance with AMCA Bulletins 210, 211A, and 300. See AMCA Standard 99, Standard Handbook, for definitions of fan terminology. The arrangement, size, class, and capacity of all fans shall be scheduled on the contract drawings.

**E. AMCA Standards:** Certified fan curves including power curves as well as acoustical data shall be submitted for each fan. All data shall be from factory test(s) performed in accordance with applicable AMCA standards. Data shall include published sound power levels based on actual factory tests on the fan sizes being furnished and shall define sound power levels (PWL) (10-12 W for each of the eight frequency bands).

**F. Fan Curves:** Fan curves shall show volumetric flow rate of the fan as a function of total pressure, brake horsepower, and fan efficiency. System curves shall include estimated losses for field installation conditions, system effect, and actual installed drive components. All losses shall be defined on the fan curves. Data may also be submitted in tabular form but tables are not a substitute for actual performance curves.

**G. Dynamic Balancing:** All fans shall be statically and dynamically balanced by the manufacturer and shall be provided with vibration isolation. All fans 18.6 kW (25 hp) and larger shall also be dynamically balanced in the field by the manufacturer upon installation completion.

**H. Corrosion:** All fan parts shall be protected against corrosion prior to operation.

**I. Belt-Driven Fans:** Belt-driven fans shall be provided with drives with multiple V-belts. Belts shall be cogged

type and shall be constructed of endless reinforced cords of long staple cotton, nylon, rayon, or other suitable textile fibers embedded in rubber.

**J. Variable-Pitch Sheaves:** Variable-pitch sheaves shall be used to accommodate initial balancing and shall be replaced with fixed pitch when balancing is complete. Sheaves shall be constructed of cast iron or steel, bored to fit properly on the shafts, and secured with keyways of proper size (no set screws) except that for sheaves having 13 mm (1/2 in.) or smaller bore set screws may be used.

**K. Furnished Complete:** Fans shall be furnished complete as a package with electric motors, motor drives, fan bases, and inlet and outlet ductwork connections.

## 6.2.8 Motor and Variable Frequency Drives

### 6.2.8.1 Motors

**A. Optimal Efficiency:** Motors utilized on NIH projects shall be premium high efficiency and selected to optimize the efficiency of mechanical and building systems. Motors shall always be of adequate size to drive the equipment without exceeding the nameplate rating at the specified speed or at the load that may be delivered by the drive.

**B. Specifications:** Motors shall be rated for continuous duty at 115% of rated capacity and base temperature rise on an ambient temperature of 40°C (105°F). Motors 560 W (3/4 hp) and larger shall be three-phase, Class B, general-purpose, squirrel cage, open-type, premium-efficiency induction motors in accordance with National Electrical Manufacturers Association (NEMA) Design B standards, wound for voltage specific to the project, 60 Hz AC, unless otherwise required by the design. Motors 373 W (1/2 hp) shall be either single or three-phase. Motors smaller than 373 W (1/2 hp) shall be single-phase, open-capacitor type in accordance with NEMA standards for 115 V, 60 Hz, AC. Motors 124 W (1/6 hp) and smaller may be the split-phase type.

**C. Power Factor:** All motors 0.75 kW (1 hp) and larger shall have a composite power factor rating of 90% to 100% when the driven equipment is operating at the design duty. Devices such as capacitors, or equipment



such as solid-state power factor controllers, shall be provided as part of the motor or motor-driven equipment when required for power factor correction.

**D. Variable Speed Drives:** Motors specified to be controlled by variable speed drives shall be rated for such use. Per Central Elevator Electronics (CEE) Premium Efficiency Criteria, minimum efficiencies for totally enclosed, fan-cooled (TEFC) motors shall be equal or greater than those shown in the minimum efficiency table included in [Table 6.2.8.1 Minimum Full-Load Nominal Efficiency of Electric Motors](#). Motors used on VFDs shall be provided with Class F insulation and will be rated for inverter duty. Motors used on VFDs shall be provided with a shaft ground ring to mitigate effects

of bearing currents and protect bearings from premature failure.

### 6.2.8.2 Variable Frequency Drives

VFDs to be used in NIH facilities shall be designed to include the following:

1. Harmonic distortion on both the supply and motor side of the VFD
2. Equipment de-rating due to harmonic distortion produced by VFDs
3. Audible noise caused by high-frequency (several kHz) components in the current and voltage

**Table 6.2.8.1 Minimum Full-Load Nominal Efficiency of Electric Motors<sup>a</sup>**

kW (hp)	Open Motors			Enclosed Motors		
	2 Pole 377 rad/s (3,600 rpm)	4 Pole 188 rad/s (1,800 rpm)	6 Pole 125 rad/s (1,200 rpm)	2 Pole 377 rad/s (3,600 rpm)	4 Pole 188 rad/s (1,800 rpm)	6 Pole 125 rad/s (1,200 rpm)
0.75 (1)	77.0	85.5	82.5	77.0	85.5	82.5
1.1 (1.5)	84.0	86.5	86.5	84.0	86.5	87.5
1.5 (2)	85.5	86.5	87.5	85.5	86.5	88.5
2.2 (3)	85.5	89.5	88.5	86.5	89.5	89.5
3.7 (5)	86.5	89.5	89.5	88.5	89.5	89.5
5.6 (7.5)	88.5	91.0	90.2	89.5	91.7	91.0
7.5 (10)	89.5	91.7	91.7	90.2	91.7	91.0
11.2 (15)	90.2	93.0	91.7	91.0	92.4	91.7
14.9 (20)	91.0	93.0	92.4	91.0	93.0	91.7
18.6 (25)	91.7	93.6	93.0	91.7	93.6	93.0
22.4 (30)	91.7	94.1	93.6	91.7	93.6	93.0
29.8 (40)	92.4	94.1	94.1	92.4	94.1	94.1
37.3 (50)	93.0	94.5	94.1	93.0	94.5	94.1
44.7 (60)	93.6	95.0	94.5	93.6	95.0	94.5
55.9 (75)	93.6	95.0	94.5	93.6	95.4	94.5
74.6 (100)	93.6	95.4	95.0	94.1	95.4	95.0
93.2 (125)	94.1	95.4	95.0	95.0	95.4	95.0
111.9 (150)	94.1	95.8	95.4	95.0	95.8	95.8
149.2 (200)	95.0	95.8	95.4	95.4	96.2	95.8

<sup>a</sup>As per efficiency values in the NEMA MG 1-2014 for NEMA premium efficiency electric motors.

**6.2.8.2.1 Variable Frequency Drive System Design**

**A. Independent Dedicated VFD:** An independent and dedicated VFD shall be provided for each prime motor and each standby motor in equipment requiring the use of VFDs.

**B. Drive Match:** Equipment motors shall be matched to the drive so that low speeds can be achieved.

**C. Bypass:** VFDs shall have a manual bypass independent of the drive. For motors 22.4 kW (30 hp) and larger, a reduced voltage starter shall be provided in the bypass circuit. See Section 10.2.3 Motor Control. Motors shall operate at full speed while in the bypass position whenever the speed drive is de-energized and/or open for service.

**D. Location:** The required location for VFDs shall be indoors. When VFD outdoor locations are allowed through an approved variance, the VFDs shall be provided in NEMA 4 enclosures, with strip heaters to mitigate condensation. VFD locations shall be as close as practical to the motor to minimize motor circuit-conductor length issues.

**E. Power Fluctuations:** VFDs that serve fans shall be able to maintain operation during short power fluctuations.

That is the VFD shall be able to maintain the operation of the motor during short interruptions of the building electrical power system without the need to shut down the equipment and without damaging the motor.

**F. Filters:** VFDs shall be provided with integral passive or active harmonic filters, phase multiplication devices, and any other components required to mitigate voltage total harmonic distortion (THD). The prescriptive harmonic allowances for VFD applications will be per Table 6.2.8.2.1 Harmonic Allowances.

**G. Documentation:** Compliance measurement shall be based on actual THD measurement at the VFD circuit-breaker terminals. Compliance shall be shown for motors loaded between 50%–100% operation. Designs that employ shunt-tuned filters shall be designed to prevent the importation of outside harmonics, which could cause system resonance or filter failure. Calculations supporting the design, including a system harmonic flow analysis, shall be provided as part of the submittal process for shunt-tuned filters. Any filter designs, which cause voltage rise at the VFD terminals, shall include documentation in compliance with the total system voltage variation of plus or minus 10%. Documentation of power quality compliance shall be part of the commissioning required by the VFD supplier.

**Table 6.2.8.2.1 Harmonic Allowances**

Motor hp	Allowable THD at Drive Input Terminals <sup>a,e</sup> (%)	Allowable iTHD at Drive Input Terminals <sup>e</sup> (%)	Allowable vTHD at Drive Input Terminals <sup>e</sup> (%)	Maximum Individual Allowable Distortion at Any Individual Harmonic <sup>e</sup> (%)	Allowable Pulse Drives <sup>b,f</sup> (%)
< 10 hp	10	10	5	5	6 pulse or higher
10 hp to < 25 hp	8	8	5	4	6 pulse or higher
25 hp to < 75 hp	5	5	5	3	6 pulse or higher
≥ 75 hp	5	5	5	3	18 pulse or higher <sup>d</sup>

Abbreviations: THD = total harmonic distortion.

<sup>a</sup> All VFD are required to comply with IEEE519 Table 10.3 for Total Demand Distortion at the Point of Common Coupling (PCC).<sup>c</sup>

<sup>b</sup> Pulse drives to include filtering as required to meet performance specification. Calculations are required prior to provision of drive for proof to support allowable harmonics claim. Ultra-Low Harmonic (ULH) drives are also acceptable for all hp ratings provided they meet maximum allowable harmonic levels.

<sup>c</sup> The NIH defined location for the PCC shall be the load side of the building transformer – essentially the switchgear (or main switchboard) bus.

<sup>d</sup> Adjustable Speed Drives (ASD) shall also be considered for motor loads greater than 75 hp.

<sup>e</sup> Compliance shall be shown for motors loaded between 50%–100% (DRM currently requires at ANY load).

<sup>f</sup> Submit harmonic study showing compliance before ordering and field measurement data after the installation.

**H. Testing:** Actual job site measurement testing shall be conducted at full-load condition and a copy of the report shall be included in the operation and maintenance (O&M) manuals. Harmonic measuring equipment utilized for certification shall carry a current calibration certificate. The final test report shall be reviewed for compliance by a manufacturer's certified representative and submitted to the PO. Text and graphical data shall be supplied showing voltage and current waveforms, THD, and individual harmonic spectrum analysis in compliance with the above standards.

**I. Wiring:** VFD incoming power wiring, wiring from VFD to motor, and motor control wiring shall be installed in separate, dedicated conduits.

#### 6.2.8.2.2 Additional Variable Frequency Drive Information

Refer to [Appendix D](#) for additional information regarding VFD and harmonic distortion.

Refer to [Chapter 10: Electrical Design](#) for additional requirements.

## 6.2.9 Emergency Electrical Power Generators

Engine exhaust system shall not create excessive back pressure on the engine and shall not be connected to any other exhaust system serving other equipment. Engine exhaust back pressure should be calculated before the exhaust system layout is finalized.

***Rationale:** Soot, corrosive condensate, and high exhaust-gas temperatures will damage idle equipment served by a common exhaust system. Excessive exhaust back pressure reduces engine power and engine life.*

Engine exhaust piping shall comply with the following:

1. Refer to [Exhibit 6.3](#) for requirements of the engine exhaust pipes.
2. Exhaust pipes shall be freestanding, not supported by the engine or muffler.

3. Exhaust pipes shall use a vibration-proof flexible connector.
4. Exhaust pipes and mufflers shall be guarded to prevent contact with personnel and avoid personnel injuries and burns.
5. Exhaust pipes shall be routed to avoid fire-detection devices and automatic sprinklers.
6. When diesel generators are to be located outdoors, a computational fluid dynamics assessment (wind/exhaust dispersion analysis) of the exhaust stream shall be performed to ensure generator exhaust is not re-entrained to any building. Exhaust pipes shall be vented to the atmosphere away from building doors, windows, and ventilation intake vents. It is recommended that the exhaust system be carried up as high as practical to maximize dispersal.
7. Insulated thimble pipe fittings shall be used at the point where the exhaust pipe penetrates the exterior wall or roof. A hinged rain cap or fabricated rain shield shall be provided on the vertical discharge.
8. Horizontal exhaust pipes shall be pitched downward and away from the generator set. At the end of the horizontal run, a condensate drain trap with hose connection shall be provided. A drain valve shall be provided at the bottom of each vertical section of the exhaust piping.
9. Locate a muffler close to the engine to reduce corrosion due to condensation.
10. Expansion joints shall be provided in long, straight runs of pipe and where exhaust changes direction.

### 6.2.9.1 Emergency Generator Room Ventilation

**A. Emergency Generator Location:** The space where the emergency generator is located shall include a ventilation system to remove heat and fumes dissipated by the engine, electrical generator, accessories, and other equipment located in the room. A maximum 11°C (20°F) room temperature rise above ambient shall be utilized in designing the ventilation air system. The

maximum room temperature shall be determined on the operating limits of other equipment in the room as well as fire-detection specifications.

1. **Remote Radiator:** Generators with remote radiators should be avoided. If remote radiators have to be used, the design team shall consult with the DTR and PO for approval.
2. **Air Intake Louvers:** Air intake louvers to ventilate the generator room shall be sized to accommodate the amount of combustion air needed by the engine, the amount of cooling air that flows to the radiator, and any other amount of air needed to ventilate the room. Control air dampers on the air intake louver shall be fast acting to meet code requirements. The intake damper shall be in a fail-safe position.

**B. Inlet and Outlet:** Inlet and outlet should not be located on the same wall and airflow shall allow to flow across the entire generator set from alternator end to radiator end.

**C. Radiator Discharge Ducts:** Radiator discharge ducts shall be self-supporting.

### 6.2.9.2 Engine's Fuel Oil System

**A. Requirements:** An emergency generator shall be provided with a safe and uninterrupted source of #2 fuel oil. The fuel oil system shall be engineered and installed to industry standards. The advantage of sub-base tank fuel tanks is that the fuel system can be factory designed and assembled; however, fuel capacity requirements and inability to refill and access the tank may make them impractical.

**B. Fuel Supply/Storage System:** The design of the fuel supply and storage system shall comply with the following requirements when using a remote fuel oil tank:

1. The fuel oil supply tank shall be located as close as possible to the emergency generators. Emergency generator(s) fuel oil shall not be used for any other purpose and shall not be shared with any other equipment. Secondary containment with leak detection and alarm is required to prevent leaking fuel from entering the soil or the sewer system. The fuel oil supply tank shall hold enough fuel oil to run the

generator(s) at full load for a minimum of 24 hours without refueling. Tank-sizing calculations shall be based on the full-load hourly fuel consumption (diesel generator sets consume approximately 0.07 gallons/hour per rated KW of fuel at full load). Other considerations for tank sizing shall include the duration of expected power outages versus the availability of fuel deliveries and the shelf life of the fuel oil. The shelf life of #2 fuel oil is 1.5–2 years. The fuel tanks must be adequately vented to prevent pressurization. Generator fuel consumption is required to be indicated in metric/dual units. Consider if a fuel polishing system will be required for fuel stabilization for large generator fuel storage tanks. The design of the fuel oil system shall specify all tank specialties such as fuel-level alarms, duplex pumps, filling accessories, control devices, and all monitoring and testing devices.

2. Underground fuel oil supply tanks shall be double-wall fiberglass and shall be provided with a leak-detection and monitoring system.
3. Day tanks shall be as close as practical to the generator's engine and shall be at an elevation where the highest fuel level in the day tank is lower than the diesel fuel injectors. Day tanks shall be vented to the outside when installed indoors. Day tanks are typically sized for 4 hours of operation for the generator set at full load.
4. Underground fuel oil piping shall be double wall fiberglass and shall be provided with a leak detection and monitoring system. Above ground fuel oil lines shall be black steel. Compatible metal fuel oil pipes and fittings shall be used to avoid electrolysis.
5. A flexible section of code-approved tubing shall be used between the engine and the fuel supply line to isolate vibration from the generator's engine.
6. Fuel oil supply pipes and pumps shall be sized to handle a fuel oil flow rate three times greater than the full-load fuel oil consumption rate specified by the generator manufacturer. In

multiple-day tank applications, the main fuel oil pump system shall be sized for three times the total fuel oil flow with all generators at full load simultaneously. Fuel oil return pipes may be sized for twice the total fuel oil flow. Engine return-fuel oil shall be piped to the fuel oil supply tank. The fuel return line shall not include a shut-off device.

7. The fuel oil supply line to each generator shall be provided with an electric solenoid shut-off valve. The solenoid valve shall be connected to the engine starter circuit to open the valve prior to energizing the generator.
8. Provisions shall be provided for manually filling the tanks should it be necessary.

### 6.2.9.3 Generator Set Noise and Selection of Silencer

Refer to [Section 10.3.2 Emergency Power Generation](#) for emergency generator noise levels and type and grade of silencers to be used.

### 6.2.9.4 Generator Space Requirements

The emergency generator sets shall be provided with adequate access and service clearances per NEC on both sides of the engine for service to allow removal of the largest component and for fuel and electrical distribution system components.

### 6.2.9.5 Generator Fire Protection Requirements

The fire protection system must comply with the authority having jurisdiction (AHJ) – the Fire Marshal on NIH’s Bethesda campus. Some of the requirements include:

1. Provide adequate ventilation in the room to prevent buildup of exhaust gases
2. Provide adequate fire-resistant construction for room
3. Provide appropriate fire-detection devices
4. Provide appropriate number of fire extinguishers in the room
5. Provide manual emergency stop outside the generator to facilitate shutting down the generator in the event of fire
6. Follow AHJ’s requirement on the amount of liquid fuel stored inside the building. Typical maximum allowed by code is 2,500 L (660 gal).

Refer to [Section 9.4 Life Safety Features](#) for additional requirements.

# Section 6.3

## Piping Systems

---

### Contents

6.3.0 Introduction

6.3.1 Hydronic Systems

6.3.2 Hydronic Pipe Sizing

6.3.3 Hydronic Pump

6.3.4 Hydronic Coil

6.3.5 Heating Water Systems

6.3.6 Chilled Water Systems

6.3.6.1 Special Purpose Chilled Water System

6.3.6.2 Chilled Water for Equipment

6.3.7 Steam Systems

6.3.7.1 Steam Pressure-Reducing Valve Station

6.3.7.2 Steam Condensate Return Unit

6.3.7.3 Steam Trap

6.3.7.4 Steam and Condensate Piping Systems

6.3.8 Freeze Protection Measures for 100%  
Outside Air Handling Coils

6.3.9 Piping

6.3.9.1 Piping Designation, Material, Fittings,  
and Joints

6.3.9.2 Piping Installation

6.3.9.3 Hanger and Support

6.3.9.4 Thermal Expansion

6.3.9.5 Welding

6.3.9.6 Piping and Equipment Identification



## 6.3.0 Introduction

Hydronic, steam, and steam condensate systems shall be designed for proper flow and control, adequate pressure and temperature, ease of system maintenance, component replacement, system reliability, and extended service life. This piping systems section shall apply to all types of NIH facilities, unless noted otherwise.

### 6.3.1 Hydronic Systems

**A. System Type:** Hydronic heating and cooling systems in general shall be forced, recirculating and closed type. Open systems are used in cooling tower applications.

**B. Capacity Control:** Hydronic heating and cooling systems shall be designed for variable flow. Pumps shall be designed to operate with variable frequency drives (VFDs). Small hydronic systems having pump motors less than 3.7 kW (5 hp) shall be designed without VFD operated motors.

*Rationale: Payback for VFD is typically not justifiable for less than a 3.7 kW (5 hp) pump.*

**C. Equipment:** Each piece of equipment shall be provided with means to determine water flow, balance, and control.

**D. Piping Network:** Parallel piping networks shall be used because they allow the same temperature at all the loads. Direct return systems may be allowed where design includes measures to prevent major flow imbalance. Systems shall be analyzed to determine if a reverse-return piping arrangement would be beneficial or practical for the project.

**E. Balancing Valve/Flow Meter Fitting:** Provide balancing valve and flow meter fitting at each floor for every riser and main branch. Flow meter fitting can either be a separate device or be part of the balancing valve.

**F. Isolation Valves/Drain Valve:** Provide drain isolation valves at the bottom of each riser and low points and isolation valves at each floor take-off.

**G. Interconnections:** Piping systems consisting of different hydronic zones shall be provided with

interconnecting means to be used when serving critical areas.

*Rationale: This provides redundancy and augments system reliability.*

**H. Expansion Tank:** Closed or diaphragm tanks shall be provided to allow for proper expansion and contraction in volumetric changes in the liquid.

**I. Air Elimination:** Air separators shall be installed on large systems and where deemed appropriate. Air separators shall be full flow, coalescing type for removal of free air, entrained air and dissolved air. Manual air vents shall be installed at high points to remove all air trapped during initial operation. Float type autovents shall be installed at all high points and equipped with shut-off valves to allow servicing without draining the system and also equipped with an anti-siphon device that does not allow the air to be entrained into the system if there is loss of pressure. The A/E and commissioning agent shall ensure there is at least 170 kPa (10 psig) positive pressure at the highest point in a closed loop system.

**J. Makeup System:** The hydronic system shall be filled with water connected to the potable water system with a service valve, backflow preventer, and pressure gauge. A safety relief valve shall also be installed in the makeup line to prevent over-pressurization of the hydronic system. A direct potable water connection shall not be provided to the glycol makeup water package so as to prevent cross-contamination of the potable water system.

**K. Pipe Expansion:** Expansion devices shall be provided when temperature changes cause dimensional changes in pipe.

**L. Safety Relief Valves:** Safety relief valves shall be provided to protect heat exchangers and systems from pressure increases caused by thermal expansion or water hammer.

### 6.3.2 Hydronic Pipe Sizing

**A. Piping Less Than or Equal to 100 mm:** Piping 100 mm (4 in.) and smaller shall be sized for a maximum velocity of 1.83 m/s (6 fps) and a maximum pressure drop of 0.4 kPa/m (4 ft./100 ft.) of piping.

**B. Piping Greater than 100 mm:** Piping larger than 100 mm (4 in.) shall be sized for a maximum velocity of 3.0 m/s (10 fps) and a maximum pressure drop of 0.4 kPa/m (4 ft./100 ft.) of piping.

### 6.3.3 Hydronic Pump

**A. Number of Pumps:** Two primary pumps and one standby pumping station are preferred over one primary and one standby arrangement. All pumps in the pump station shall be rated at equal size to prevent the larger pump from over pressurizing the smaller pump. The minimum flow rate of the pump shall be within the operating range of the VFD.

**B. Future Capacity:** The pump capacity shall be increased by 20% to allow for future expansion.

**C. Suction:** Primary distribution pumps shall be base-mounted, end-suction or split-case double suction. Close-coupled pumps are not acceptable.

**D. Centrifugal Speed:** Pumps shall be centrifugal type with a maximum speed of 188 rad/s (1,800 rpm).

**E. Size:** In-line pumps shall not exceed 5.6 kW (7.5 hp) in size.

**F. Safe-Service:** In-line pumps may be located overhead provided that a safe-service platform and permanent rigging device is installed to accommodate replacement of the pump.

**G. Individual Starter/VFD:** Each pump shall be provided with its individual starter or VFD.

**H. Isolation Valve:** Isolation valves shall be provided on suction and discharge lines.

**I. Strainer:** Provide pipe strainer or suction diffuser with strainer.

**J. Flexible Connections:** Provide flexible connections on suction and discharge. In-line pumps shall not be provided with flexible connectors.

*Rationale: In-line pumps rely on direct connection to the piping for stability.*

**K. Check Valve:** Provide a check valve on discharge.

**L. Balancing Valve:** Provide a balancing valve with memory stop on discharge.

**M. Gauge:** Provide a single-pressure gauge with isolation valve to serve both suction and discharge lines.

**N. Differential-Pressure Bypass Control Valve:** The use of a differential-pressure bypass control valve (DPBCV) across the pump on a variable speed pump is not permitted. A DPBCV across the pump may be allowed in fixed-speed pump serving zones controlled by two-way valves.

*Rationale: A differential-pressure bypass control valve located near the pump discharge saves very little energy and is often not adjusted as loads change.*

**O. Piping Support:** Piping to the pump shall be independently supported and shall not add load to the pump flanges.

### 6.3.4 Hydronic Coil

**A. Control Water Flow:** All hydronic coils shall be provided with the means to determine water flow, balance, and control. Large-capacity coils, over 0.63 L/s (10 gpm), shall be provided with pipe-mounted flow meter fitting.

**B. Pressure/Temperature Plug:** Small-capacity coils exposed or concealed shall be provided with a pressure/temperature plug on the supply and return piping. Small capacity coils typically refer to a unit heater or fan coil unit serving an individual space.

**C. Thermometer and Pressure Gauge:** Large capacity coils such as on AHU shall be provided with a permanent thermometer and pressure gauge on supply and return piping.

**D. Control Valve:** All terminal coils and equipment on VFD operated systems shall be provided with a two-way modulating control valve. Where a three-way valve is required, the flow rate through the valve shall match as close as possible to the minimum water flow of the variable speed pump. Control valves shall be equal percentage type. Control valve shall be sized based on the required flow coefficient  $C_v$  for the required pressure drop and flow.

**E. Return-Water Side:** Two-way control valves shall be installed on the return-water side of the coil.

**F. Isolation Valve:** Provide isolation valves in the supply and return water piping.

**G. Strainer:** Provide a fine mesh strainer in the supply water piping.

**H. Air Vent:** Provide air vents with shut-off valves in the supply and return piping if not already provided with the coil.

**I. Drain Valve:** Provide a drain valve in the supply and return water piping. The drain valve shall include 19 mm (3/4 in.) hose bib with cap.

**J. Piping:** Provide a minimum of 19 mm (0.75 in.) piping to all coils regardless of the flow rate.

**K. Balancing Valve:** Provide a balancing valve in the return pipe on a two-way valve control arrangement. Where a three-way control valve is provided, a balancing valve shall also be provided in the bypass leg of the three-way control valve.

**L. Test Ports:** Test ports shall be provided across the coils. Ports shall be installed on entering and leaving side of each coil including each individual coil in a stacked coil arrangement.

### 6.3.5 Heating Water Systems

**A. Purpose/Type:** Heating water systems on the NIH Bethesda campus are mainly generated from plant steam. The heating water system shall operate as a hot water low temperature system (HWLT) with maximum temperature of 121°C (250°F). All design requirements included in this section shall apply to HWLT systems. The heating water shall serve preheat coils, reheat coils, perimeter radiation, fan coil units (FCUs), etc. These systems can be constant or variable flow and include heat exchangers, duplex distribution pumps, expansion tank(s), makeup water provisions, chemical pot feeder, air separator, and two- or three-way terminal device control valves.

**B. N + 1 Redundancy:** Heating water systems shall be designed to offer N + 1 redundancy for reliability and maintain 100% capacity in the event a lead component fails. The redundancy applies to heat exchangers and

pumps. On large systems, three sets of heat exchangers and pumps are preferred – two to carry the load and one as standby.

**C. Heat exchanger:** Steam to water heat exchangers for hot water heating shall be shell and tube type with a multi-pass design and counterflow operation for maximum performance. The unit shall be ASME stamped as a pressure vessel. The entire heating water system may be provided as a manufactured assembled package. The manufactured package shall provide sufficient room to service all components and facilitate replacement of major components, while keeping the remaining system fully operational.

**D. Future Capacity:** The heat exchanger capacity shall be increased by 20% to allow for future expansion.

**E. Separation:** Heating water systems shall be segregated by water temperature, the application, and load served. Systems may be combined where temperature and profiles are similar. Further separation to subsystems shall be considered only if proven cost-effective by the life cycle cost analysis.

*Rationale: A single common heating system serving all the heating loads in the building is not energy-efficient and may be problematic in terms of setting a common temperature that meets all the loads.*

**F. Glycol Solution:** Heating water systems to serve pre-heat coils shall have a minimum 40% propylene glycol solution (by volume). In locations other than the Bethesda campus, the glycol solution shall be selected appropriate with the weather. A glycol-fill package shall be provided.

### 6.3.6 Chilled Water Systems

**A. Connection:** At the NIH Bethesda campus, cooling is mainly accomplished with chilled water. Chilled water systems for buildings in the Bethesda campus and Poolesville north campus shall be provided from the existing chilled water site distribution system. Connection to the site distribution piping system shall be achieved by extending the existing utility tunnel to the building or by installing chilled water pipes in accessible pipe trenches between the utility tunnel and the building wall.

**B. Unitary Direct Expansion Equipment:** Direct Expansion (DX) HVAC systems are prohibited except where chilled water is not available in close proximity or where process requirement dictates the use of DX cooling for precision temperature control. The A/E shall provide a detailed justification for using DX equipment with the variance request to the DTR for review early during the design process, see [Section 1.5 Project Design Review](#) for variance request procedures.

**C. Chilled Water Temperature:** Chilled water coils shall be selected for an entering water temperature (EWT) of 7.2°C (45°F) and leaving water temperature (LWT) of 15.6°C (60°F) at peak demand.

***Rationale:** The coil EWT is based on the secondary chilled water supply temperature leaving the plant during peak season and factors the temperature loss in the secondary and tertiary distribution piping system. A 8.3°C (15°F) chilled water delta T at the coil ensures reduced flow rates, pipe size, pumping energy, lower first cost, and a more efficient central plant.*

**D. Types of Piping Distribution Systems:** The terms primary, secondary, and tertiary piping distribution systems refer to the following:

1. **Primary:** Piping distribution at the central chiller plant
2. **Secondary:** Site (campus) piping distribution
3. **Tertiary:** Piping distribution within an individual building connected to the site loop

**E. Bethesda/Poolesville Campuses:** Individual buildings on the Bethesda and Poolesville campuses shall each be provided with a tertiary, variable speed chilled-water pumping system and follow the below requirements (See [Figure 6.3.6 Building Tertiary Pumping System Schematic](#)):

1. Isolation valves with tamper switches to indicate valve position (open and closed) shall be provided in supply and return piping at the point where the secondary chilled water piping enters the building.

***Rationale:** This provides primary isolation from the site distribution piping system.*

2. The bridge return control valve shall be designed to control the temperature and limit the flow of water from the building tertiary piping to the secondary chilled water system. Control valves shall be of high quality and industrial grade. Control actuators shall be sized to close against anticipated system pressure so valve seats are not forced open. Control valve actuators shall be slow closing to mitigate pressure transients and water hammer. The control valve shall be visible from the mechanical room floor under all circumstances.

***Rationale:** High quality valves provide more precise control, longer service life and minimum maintenance.*

3. The common pipe in the decoupler loops shall be a minimum of 10 pipe diameters in length to reduce the likelihood of unwanted mixing resulting from velocity, energy, or turbulence. An isolation valve or check valve is not recommended in the common pipe since it increases the pressure drop in the common pipe and does not make it a true decoupled system.
4. Isolation valves shall be of high-performance type butterfly valve with bidirectional shut-off to 1,966 kPa (285 psi).
5. No mechanical joint piping is allowed in the secondary/tertiary loop piping near the service entrance or in the mechanical room.

***Rationale:** Mechanical joint piping is susceptible to joints separating when subject to sudden closure of valves in the distribution piping.*

6. Flow meters in the secondary/tertiary loop shall be selected based on accuracy required, expected turndown ratio, clearance, and straight piping requirements upstream and downstream of the flow meter to achieve the claimed accuracy. An electromagnetic type or a dual turbine type meter is required because of greater accuracy and reliability.

**Rationale:** Electromagnetic meters have the lowest straight pipe requirements while dual turbine type meters require the smallest physical space.

7. To minimize the need for spare parts, NIH has standardized a few types and makes of flow meters used throughout NIH campuses. The A/E shall coordinate with NIH during design.
8. A bidirectional flow meter in the decoupler pipe may be used to monitor the direction and amount of flow.

**F. Large Facilities:** For large facilities with floor areas greater than a gross 9,290 m<sup>2</sup> (30,000 ft<sup>2</sup>), consideration shall be given to providing multiple building chilled water services to the building's tertiary pumping system.

**Rationale:** Multiple services provide diversity in the chilled water delivery system in the case of pipe, valve, or system component failure.

### 6.3.6.1 Special Purpose Chilled Water System

**A. Areas Requiring Low Temperature and Humidity:** In general, EWT of 7.2°C (45°F) is sufficient to provide the supply air dewpoint temperature required to maintain the design room conditions. Where lower temperature and/or humidity conditions are required, dual coils in series may be provided. It is preferred that chilled water be used for second stage cooling. Where approach temperatures prohibit the use of secondary chilled water coil, a separate DX chiller may be used. The A/E shall review the project's program requirements and submit the proposed design to the NIH for review early in the design process.

**B. Separate System:** Chilled water systems serving areas driven by high sensible loads such as in a data centers may be hydraulically separated from the rest of the building piping distribution system to achieve energy-efficiencies. Similarly, chilled water supplied to chilled beams requiring 13.9°C (57°F) chilled water may be hydraulically separated from the rest of the building

Figure 6.3.6 Building Tertiary Pumping System Schematic

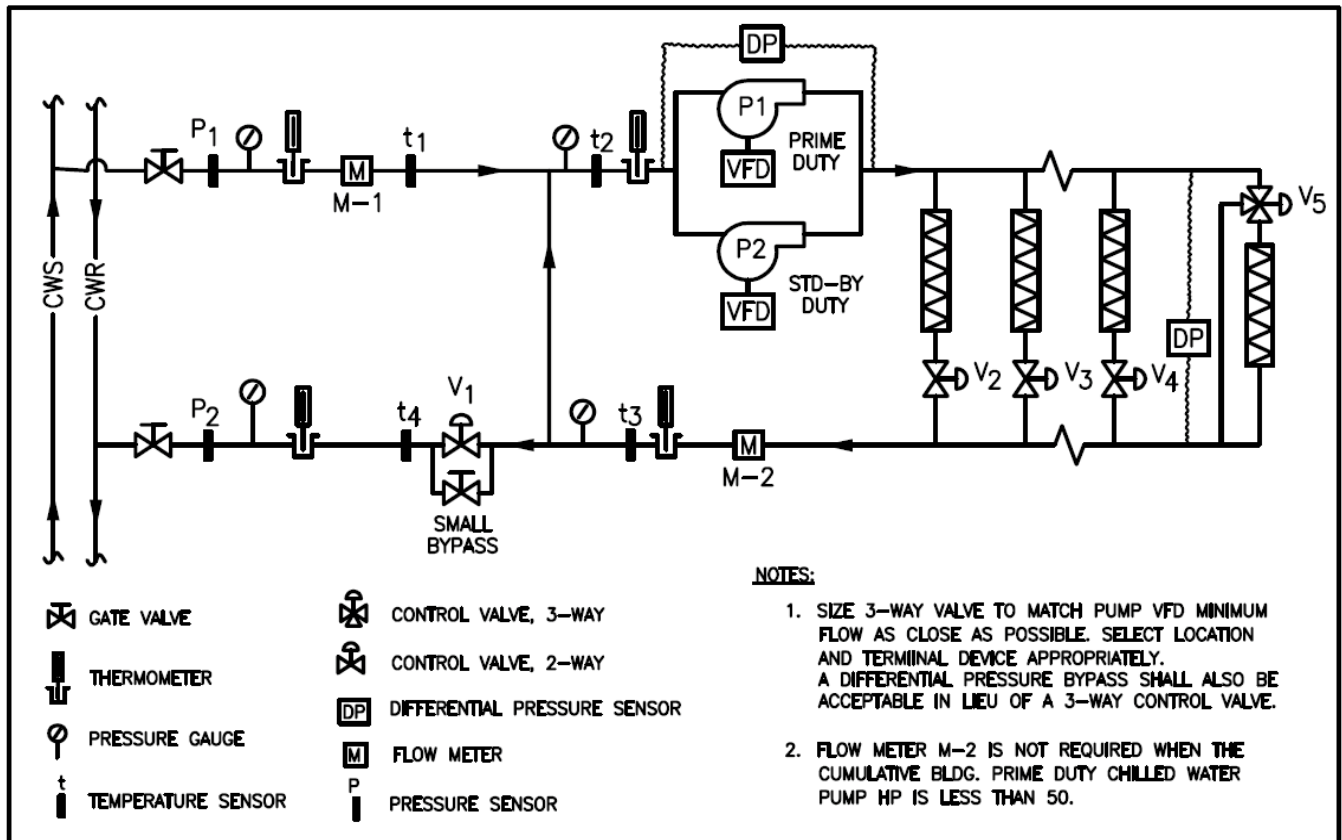



pipng distribution system to achieve energy-efficiencies and reduce potential for condensation from colder pipes. These systems shall be provided with water-to-water heat exchangers and dedicated pumping stations for thermal transfer. N+1 redundancy and 20% future capacity shall be provided for heat exchangers and circulating pumps.

**C. Year Round Cooling:** Spaces that require chilled water for cooling year round such as an interior laboratory space, equipment rooms, or conference rooms may be provided with a separate pump, unless the main tertiary pump can handle the minimum flow rate required to operate the VFD.

**D. Precision Temperature Control:** Special areas such as an electron microscope room requiring precision temperature control may be provided with a dedicated chiller or a decoupled chilled water loop using a water-to-water heat exchanger. Proportional Integrated and Derivative (PID) controllers shall be used in conjunction with Class A, Resistance Temperature Detectors (RTDs) or Thermistors to control room temperature. The A/E shall review the project's program requirements and submit the proposed design to the NIH for review early in the design process.

**E. Critical Areas:** Special areas of a critical nature and which must remain in operation continuously shall be provided with a supplemental chiller to backup the central system. A supplemental chiller may be in direct contact with the building tertiary loop or connected through a heat exchanger as the specific application dictates. Systems serving areas of a critical nature shall offer 100% redundancy for all vital components and shall be powered from an emergency power source. A chilled water thermal storage tank may also meet the backup cooling requirement if considered more feasible and economical. The A/E shall review the project's program requirements and provide a risk assessment to support the need for a supplemental chiller backup and submit the proposed design to the NIH for review early in the design process.

### 6.3.6.2 Chilled Water for Equipment

**A. Process Laboratory Equipment:** Chilled water for process laboratory equipment such as lasers, electron microscopes, MRI equipment, CT scanners, PET

equipment, mass spectrometers, etc., shall be provided by a dedicated chiller or decoupled chilled water loop using a water-to-water heat exchanger.

*Rationale: Plant chilled water is not used because it is typically too cold, does not have adequate pressure differential, or the desired water quality required for the equipment.*

1. Plant chilled water shall be used to cool heat rejection from water-cooled chillers, unless condenser water from a cooling tower is available.
2. Air-cooled chillers should be avoided if located indoors because they introduce undesired heat into the space and can be noisy.
3. The A/E shall coordinate with the manufacturer and their requirements for the chiller or fluid-to-fluid heat exchanger.
4. Chiller or fluid-to-fluid heat exchanger, supplying process equipment shall be industrial grade, rugged, and with durable components.

**B. Water-Cooled DX Units:** Plant-chilled water shall be used to cool heat rejection from water-cooled DX units serving environmental rooms such as walk-in refrigerators and freezers unless condenser water from a cooling tower is available.

**C. Once-Through Potable Water:** Once-through potable water for cooling process equipment or environmental rooms is prohibited except where used for emergency backup.

**D. Critical Process Equipment:** Process equipment of a critical nature, which must remain in operation continuously, shall be provided with a redundant chiller or a chiller with a backup decoupled chilled water-loop heat exchanger. Systems serving process equipment of a critical nature shall be powered from an emergency power source. The A/E shall review the project's program requirements and submit the proposed design to NIH for review early in the design process.



## 6.3.7 Steam Systems

**A. Bethesda Campus:** At the NIH Bethesda campus steam is generated at the central steam plant in Building 11 and distributed at a pressure of 1,138 kPa (165 psi). Steam condensate is collected and returned to Building 11 through a series of low-pressure pumped return mains and high-pressure drip condensate piping.

**B. Usage:** Steam systems are extensive and serve a variety of equipment and systems such as sterilizers, autoclaves, cage washing equipment, HVAC systems, domestic hot water, etc. The need for clean or pure steam shall be reviewed with the program user group for unique applications such as autoclaves serving barrier facilities (e.g., SPF, transgenic), where autoclaves may be used for sterilizing animal drinking water, for pharmaceutical (e.g., WFI and other pure steam requirements), and for other applications as justified by a unique programmatic need.

**C. Classifications:** NIH steam systems and distribution piping are classified as follows:

1. Low-pressure steam: 138 kPa (20 psi) and below
2. Medium-pressure steam: 145–552 kPa (21–80 psi)
3. High-pressure steam: 558 kPa (81 psi) and above

**D. Steam Pressure:** Steam to the equipment listed below shall be supplied at the indicated steam pressure; however, radiators, convectors, air-heating coils, and unit heaters may be supplied with heating water in lieu of steam:

1. Air-heating coil: 97 kPa (15 psi) maximum (higher pressures may be used if justified by engineering or economic considerations)
2. Central humidifier within AHU: 97 kPa (15 psi) maximum
3. Convector: 97 kPa (15 psi) maximum
4. Dietetic equipment: As specified by the equipment manufacturer
5. Domestic hot water heater: 552 kPa (80 psi) maximum
6. Heating water heat exchanger: 97 kPa (15 psi) maximum

7. Duct mounted humidifier: 97 kPa (15 psi)
8. Radiator: 97 kPa (15 psi) maximum
9. Unit heater: 97 kPa (15 psi) maximum
10. Sterilizer and cage washer: As specified by the equipment manufacturer

**E. Return Distribution System:** The steam supply and steam condensate return distribution system shall be sized conservatively with minimal line pressure loss at maximum design load plus allowances for warm-up and future growth. All valves, traps, equipment, and specialties shall be selected and sized for their intended use and shown in the construction documents. Sizing consideration shall include warm-up factors and estimated inlet and outlet pressures. Steam condensate shall be collected and returned to the central steam plant.

**F. Connection to the Site Distribution Piping System:** Connection to the site distribution piping system shall be achieved by extending the existing utility tunnel to the building or by installing steam and condensate pipes in an accessible pipe trench between the utility tunnel and the building wall.

### 6.3.7.1 Steam Pressure-Reducing Valve Station

**A. Stations:** Steam pressure-reducing valve (PRV) stations shall be provided near the steam service entrance into the building. PRV stages shall be as follows:

1. **Medium to low:** 552–97 kPa (80–15 psi)
2. **Medium to medium:** 552–276 kPa (80–40 psi)
3. **High to medium:** 1,138–552 kPa (165–80 psi)

**B. PRVs:** Secondary and/or remote PRVs, within the building, should be avoided. Second-stage PRVs may be installed in mechanical penthouses/rooms or other easily accessible mechanical spaces. Small PRVs that serve isolated equipment such as a glass washer with different pressure requirements may be installed close to the equipment being served, provided that it is located in a service corridor or other accessible and suitable space.

**C. Steam Consumption:** PRV stations shall be sized for the calculated peak demand. For process equipment load, the PRV shall be sized, as a minimum, for 100%

steam consumption of the largest single user plus 25% steam consumption of all other users.

**D. High-Pressure Steam:** Where a single PRV would exceed 75 mm (3 in.) in size or the turndown ratio (maximum load/minimum load) is greater than 10:1, two PRVs shall be provided in parallel, one for approximately 0–33% for low-load conditions and one for 33–100% for high-load conditions, with a single full pipe size bypass. In no case shall high-pressure steam be reduced in a single stage to 276 kPa (40 psi) or less.

**E. Large PRV station:** For a large PRV, where valve size would exceed 150 mm (6 in.), three PRVs shall be provided in parallel, one for approximately 0–33% for low-load and two for 33–100% for high-load conditions with a single bypass.

**F. Bypass Valves:** Bypass globe valve shall be provided around the PRV station and modulate pressure if the PRV is out of service. Ball valves are not appropriate for the steam service. Isolation gate valve will be provided for isolation.

**G. Load Capacity:** Where the steam service includes capacity for future expansion, all PRV station piping and components, except the PRVs, shall be sized for the future. The PRV shall be sized for the present load. An eccentric reducer before the PRV and concentric reducer after the valve shall be installed so that condensate does not collect within the station.

**H. Single Shut-off Valve:** The PRV station and header shall be fabricated using fully welded fittings and flanged valves. The high-pressure main shall have a single shut-off valve capable of securing all steam to the building. Each branch of the PRV station shall have a single shut-off valve capable of securing steam without approaching the station. The PRV station shall be isolated from the structure to limit structure-borne noise. The maximum valve NC level shall not exceed 85 dB at all anticipated loads.

**I. Insulation Jacket:** The PRV shall be fitted with removable custom fabric insulation jacket to further reduce noise and heat gain to the space. The insulation jacket shall be equipped with straps and buckles to allow frequent removal and reinstallation without damaging the insulation.

**J. Steam Pilot Line:** A steam valve pilot line shall be sloped down to tie into mains and shall be contained

within isolation shut-off valves. Pilot lines shall be at least 7 mm (0.25 in.) in diameter to prevent clogging.

### 6.3.7.2 Steam Condensate Return Unit

**A. Steam Condensate Receiver:** Steam condensate receivers shall serve steam condensate low-pressure mains. The receiver shall not be used as a flash tank or have high- or medium-pressure condensate directly piped, regardless of capacity. High- and medium-pressure steam condensate return shall be piped to separate flash tanks.

**B. Condensate Return Unit:** Condensate return units (CRUs) shall be duplex electric, steam, or compressed-air powered. A CRU will have the following design requirements:

1. Pump shall have Viton seals and stainless steel shaft.
2. Each pump shall have isolation valves on both the inlet and discharge lines to allow each pump to be taken out of service without removing the CRU from service.
3. Each condensate return unit shall be piped with a full-size bypass line to drain. The bypass shall serve as emergency manual drainage for condensate if the return unit is offline. The bypass shall be indirectly piped to the sanitary system and have a cooling trap to temper condensate down to a suitable temperature prior to discharge.
4. The condensate receiver shall be vented outdoor and independent of other steam-relief vents. The CRU shall have fully packaged controls, starter, alternator, disconnect, and high-level alarm. The high alarm shall be tied to the building automation system.
5. Pump motor starter shall be clearly identified, and where practical, shall be mounted on a common panel.
6. If a duplex condensate pump is installed in the pit, the starter, disconnect switch, and alternator shall be located above the pit where it is easily accessible. Locating any serviceable equipment in a confined space shall be avoided.

### 6.3.7.3 Steam Trap

**A. Specification:** Steam trap shall be sized for the particular application. Refer to [Table 6.3.7.3 Recommendations for Steam Trap Applications](#) for a list of the specific steam traps to be used for the different steam applications as well as the associated safety factors to be used in the selection of steam trap.

**B. Trap Bypass Valve:** Trap bypass valves shall not be installed; if redundancy or additional capacity is required, dual traps shall be installed.

**C. Location:** All traps, except those on radiation heating equipment, shall be located a minimum 150 mm (6 in.) below the equipment they service.

**Table 6.3.7.3 Recommendations for Steam Trap Applications**

Application <sup>a</sup>	Steam Trap Sizing Safety Factor	Steam Trap Type <sup>e</sup>			
		Float/Thermostatic	Balanced Pressure Thermostatic	Disk Thermo-Dynamic	Inverted Bucket
<b>Kitchen Warming Equipment<sup>b</sup></b>	2	X			
<b>Laboratory Equipment<sup>c</sup></b>	2	X			
Autoclaves and sterilizers, medium pressure	2				X
<b>Heating Equipment</b>					
Shell and tube heat exchangers	2	X			
Steam coils <sup>d</sup>	4	X			
Cabinet and unit heaters <sup>f</sup>	3	X			
Radiant panels and strips	2	X			
Radiators and convection cabinet heaters	2		X		
Humidifiers	2		X		
Water heaters	2	X			
Water heaters – medium pressure	2				X
<b>Steam Piping</b>					
Horizontal runs and low point drains	2	X			
Horizontal runs and low point drains – medium pressure and high pressure	2			X	
Flash tanks	2	X			
Flash tanks, medium pressure and high pressure	2			X	

<sup>a</sup> Unless noted otherwise, all equipment in this table is served with low-pressure steam.

<sup>b</sup> Steam traps associated with kitchen-warming equipment shall be as per this table unless noted otherwise by the kitchen equipment manufacturer.

<sup>c</sup> Steam traps associated with laboratory equipment shall be as per this table unless noted otherwise by the laboratory equipment manufacturer.

<sup>d</sup> Top of traps serving steam coils shall be installed a minimum of 300 mm (12 in.) below the bottom of the coil.

<sup>e</sup> Trap bypass valves shall not be installed; if redundancy is required or capacity dictates, dual traps shall be installed.

<sup>f</sup> Equipment with a modulating control valve.

### 6.3.7.4 Steam and Condensate Piping Systems

**A. General:** Piping shall be designed and installed to allow for expansion and contraction without creating excessive stresses and strain in the piping system. Expansion loops, offsets, pipe guides, and anchors shall be shown on the contract documents. Expansion joints shall be provided as a last resort. Expansion joints shall not be installed above ceiling within a critical space. Pipe anchors shall be designed for each location and sized to handle all forces with conservative safety factor. All anchors, guide loops, and joints shall be readily accessible for maintenance and inspection.

**B. Sizing:** Steam and steam condensate piping shall be sized in accordance with the parameters in [Table 6.3.7.4 Steam and Steam Condensate Piping Design Criteria](#).

**C. Classification:** Regardless of steam- and condensate-pressure classification, all pipe and fittings shall be rated for minimum pressure of 2,067 kPa (300 psi). Steam piping shall be a minimum schedule 40 and condensate piping, a minimum schedule 80. Steam connections to equipment 80 mm (2.5 in.) and larger shall be flanged and shall be threaded for sizes 50 mm (2 in.) and smaller. Flange gasket and bolt shall be suitable for operating pressure and temperature of the system. Hardware shall be selected so that temperature and pressure fluctuations in the system and expansion/contraction do not affect performance over time.

**D. Condensate Piping:** Condensate piping shall be gravity drained from the trap to the condensate receiver for all low pressure-steam applications. Traps on steam coils shall be at least 350 mm (14 in.) below the coil's discharge. Where the hydraulic head is not achievable, a condensate pump shall be utilized. Under no circumstances shall condensate be lifted after a steam-modulating device.

**E. Drip Leg:** Drip legs shall be provided in all steam mains to accommodate condensate drainage at all locations. Drip connections shall be provided at the base of each low point in mains and just before all equipment connections. Drip legs shall be provided in steam piping prior to connecting to laboratory process equipment to prevent the buildup of steam condensate. Steam condensate shall drain away from laboratory process equipment. Steam instrumentation sensors require a 6 m (20 ft.) long sensing line from header to sensor to protect it from extensive heat.

**F. Steam Distribution Mains:** High-pressure drip lines on steam distribution mains shall be routed to a flash tank and not connected to pumped condensate return lines.

**G. Flash Tanks:** Flash tanks shall be provided for high-pressure and medium-pressure condensate and before connection to the condensate receiver. The flash tank shall be factory fabricated and ASME stamped and approved. A contractor shop-fabricated tank is not

**Table 6.3.7.4 Steam and Steam Condensate Piping Design Criteria**

Steam Pressure Service	Steam Supply Mains and Risers			Steam Condensate Return Mains and Risers	
	Maximum Total System Pressure Drop <sup>a</sup> %	Maximum Friction Rate kPa/m (psi/100 ft.)	Maximum Steam Velocity <sup>b</sup> m/s (fpm)	Maximum Total System Pressure Drop <sup>a</sup> %	Maximum Friction Rate kPa/m (psi/100 ft.)
High-pressure 558 kPa (81 psi) and above	10	0.50–2 (2–8)	50 (10,000)	10	0.50 (2)
Medium-pressure 145–552 kPa (21–80 psi)	5	0.50 (2)	40 (8,000)	5	0.25 (1)
Low-pressure 145 kPa (20 psi) and below	5	0.50 (2)	30 (6,000)	5	0.10 (0.5)

<sup>a</sup> Percentage of initial system pressure for supply or return mains.

<sup>b</sup> The need for higher steam velocity needs to be reviewed by the NIH.

acceptable. Flash tanks shall be vented directly to the outside with a relief valve of the proper size. Flash steam is waste energy and can be recovered either by installing a heat exchanger (vent condenser) to provide preheat for domestic hot water application, or by connecting the steam vent to an active low pressure steam mainthrough an appropriate pressure regulating valve. In this case a check valve must be installed to prevent backflow if the flash tank pressure should drop. A back pressure valve shall also be installed to control the maximum pressure in the tank and relief valve to protect the system.

**H. Steam Control Valve:** A steam control valve shall be fully proportional with a modulating equal-percentage plug.

*Exception: Steam control valve serving integrated face and bypass damper steam coil shall be non-modulating.*

**I. Control Valve Trim:** A steam control valve shall have stainless steel trim and be suitable for the pressure condition, additionally it shall operate with the differential pressure required.

**J. Control Valve Arrangement:** Steam control valves serving heat exchangers shall be provided with one-third/two-thirds control valve arrangements to provide better controllability.

**K. Steam Valves and Specialties:** Steam valves and specialties shall be of the industrial high-performance type. Positive shut-off and isolation of mains are critical to the safety of maintenance personnel. Stainless steel seats and disks are required. A shut-off gate valve shall be used in all steam and condensate lines; gate valves shall be OS&Y 300# ANSI for high, medium, and low-pressure systems. Bronze stemmed gate valves are recommended for use at the NIH campus. All insulated valve stems shall be extended as required to permit sufficient clearance for proper operation without damaging the insulation.

**L. Safety-Relief Valves:** Steam safety-relief valves shall be piped individually and discharged no less than 2.1 m (7 ft.) above the building roof. Care shall be taken not to locate discharge close to outdoor air intake or where they could be a hazard to maintenance personnel. Relief valves shall not be connected to other steam vents. All valves, drip pan elbows, and relief lines shall meet ASME requirements.

**M. Warm-Up Valve:** A warmup valve shall be provided to bypass shut-off valves on each building main shut-off valve larger than 75 mm (3 in.).

**N. Steam Strainer:** A steam strainer shall be positioned horizontally (flat) to prevent condensate from collecting in the bottom of the strainer and reducing its life.

**O. Steam Vacuum Breaker:** Steam vacuum breakers, not check valves, shall be used on coil and heat exchangers to eliminate any vacuum. Vacuum breakers shall be located external to AHU casing.

**P. Steam Pressure Gauge:** Steam pressure gauges shall be liquid filled with a range consistent with operating pressure. Stainless steel ball valves shall be used for gauge cock.

## 6.3.8 Freeze Protection Measures for 100% Outside Air Handling Coils

**A. Coil Ruptures:** Coil ruptures within a 100% AHU can cause significant property and equipment damage due to floods which can, disrupt ongoing research in buildings and cause major distress to animals. The A/E shall include the following measures in the design of the AHU:

1. Provide adequate coverage of freezestat. Provide installation detail on design documents.
2. Provide leak detector in and around AHU. All leak detectors shall be wired in series except those prone to wetting, such as coils in cooling coils discharge plenums or those subject to wet maintenance operations.
3. Ensure proper selection of a preheat coil, which is not to be based on the full face area of the air handler.

*Rationale: Preheat coil sized for full face are typically relatively thin, which allows for stratification at lower loads. Temperature stratification across the coil may cause freeze trip and coil rupture.*



4. Ensure proper selection of preheat control valve.

**Rationale:** *Proper selection of the control valve is critical for controllability of any coil. The goal is to provide a control valve with proper “control authority” to ensure that a change in the control valve position will have a commensurate change in the coil output. If valves are oversized, there is minimal effect on the coil until it is nearly closed.*

**B. Even Airflow Profile:** Maintain even airflow profile across the coil to provide proper coil performance. Provide proper inlet conditions to maintain even coil air velocity.

**C. Glycol Preheat Coil:** Provide a redundant circulating pump on glycol preheat coil.

**Rationale:** *Circulating pumps ensure that turbulent flow is maintained in the coil at reduced load. Coil circulating pumps allow recirculation if the preheat supply system fails, delaying the coil from freezing.*

**D. Steam Coil Considerations:** Where steam coils are used, they must be applied carefully. Design considerations with steam coils include the following:

1. Condensate must be effectively drained from the coils so that it does not freeze or cause cold airflows that freeze downstream coils.
2. Coils must be properly vented. Modulated steam will typically be at subatmospheric pressure and will tend to hold condensate. Venting will relieve pressure and not allow cold spots on the coil.
3. A single modulating steam-control valve shall be avoided because they will typically create subatmospheric pressure in the coil and tend to hold condensate in the coil. A one-third/two-third valve arrangement helps in the controllability.
4. Steam must be effectively distributed through all the circuits in the coil, particularly at low loads. Uneven distributed steam is particularly a problem in full face coils that are thin.
5. Provide a redundant steam trap on the preheat coil to ensure condensate is removed when a trap fails or is plugged.
6. Provide proper venting on the condensate system so coils are not subject to back pressure.
7. The bottom of the steam coil should be adequately elevated to allow for the critical head on the condensate to ensure it drains effectively.
8. A vertical integral face and bypass dampers (IFB) steam coil is preferred over a non-freeze steam distribution coil. Sufficient space however shall be provided downstream of the IFB coil to allow airflow to mix properly and equalize before it hits the cooling coil.

**Rationale:** *A steam IFB coil provides increased reliability and controllability over non-freeze steam distribution coils. IFB coils allow full steam pressure to be put on the coil when temperature drops below 4°C (40°F) after which the face and bypass damper modulate to control capacity. This helps both steam distribution and condensate drainage.*

**E. Cooling Coil Circulation Pump:** Provide a cooling coil circulation pump. The pump should be installed in the bypass position. The pump should run below a certain cooling coil position and when entering air temperature falls below a certain value. This lowers the probability of coil freezing.

**F. Access/Power:** Coil circulation pumps shall be either in-line or base mounted and located for easy service. Coil circulating pumps shall be powered from an emergency power source.

**G. Isolation Valve:** Automated isolation valves may be required on chilled water supply pipes to the air handler coil in order to prevent chilled water from flooding the mechanical room if a chilled water coil breaks. The isolation valve will close on water detection to prevent flooding. This requirement is applicable on large air handlers typically located above an occupied space. The A/E shall review this requirement with NIH early in the design process.



## 6.3.9 Piping

### 6.3.9.1 Piping Designation, Material, Fittings, and Joints

**A. Requirements:** Piping designations, material, fittings, and joints shall be as indicated in [Exhibit 6.3 Piping Designation, Material, Fittings, and Joints](#).

**B. Method Selection:** Selection of pipe materials and installation methods shall incorporate special requirements unique to individual program areas, such as consideration of magnetic fields, special materials, shielding, as well as all types of chemical exposure, etc.

**C. Tubing:** Type L (hard-drawn) wall-thickness tubing may be used in lieu of type K (hard-drawn) for copper piping for above-ground water piping installations serving extramural projects located outside of the metropolitan Washington, D.C. area if prevailing practice and water supply conditions are compatible with type L (hard-drawn) copper tubing. Water piping installation at the NIH Bethesda Campus and Poolesville facilities shall utilize type K (hard-drawn) tubing as indicated in [Exhibit 6.3 Piping Designation, Material, Fittings, and Joints](#).

**D. Drain Trap Material:** Drain trap material selection shall be done in consideration of the different products to be disposed into the sewage system. Disposal of chloride-containing products into the sewage system has been identified as one of the causes for pitting problems in sewage systems made of 316 stainless steel. Refer to ORF Bioenvironmental Studies found at: <http://orf.od.nih.gov/PoliciesAndGuidelines/Bioenvironmental/>.

### 6.3.9.2 Piping Installation

**A. Minimum Pipe Size:** The minimum pipe size shall be 19 mm (0.75 in.) for HVAC systems. Size reductions may occur only immediately adjacent to equipment connections and at tee pipe fittings.

**B. Valve:** Control valves and specialties serving equipment shall be a full pipe size, not the reduced equipment connection size, unless engineering calculations specify differently.

**C. Accessibility:** No piping shall penetrate ductwork. Unions or flanges on each side of all pieces of equipment, and other similar items, shall be designed in such a manner that they can be readily disconnected. Unions

and flanges shall be placed in a location that shall be accessible after completion of the project. Piping and conduit (except electrical conduit run within floor construction) shall be designed to run parallel to the building structure.

**D. Drip Pan:** Hydronic and steam piping shall not be located within an electrical room or secondary switchgear room. In the event that this cannot be avoided, protection such as drip pan shall be provided beneath all piping and equipment. Drip pan shall be provided with water detection alarm connected to the BAS. The piping and drip pan shall never be located over any electrical transformer, electrical panel, or switchgear.

**E. Installation:** The different service pipes, valves, and fittings shall be installed so that after the insulation/jacketing is applied, there shall not be less than 25 mm (1 in.) clear space between the finished jacketing and other work, as well as between the finished jacketing and parallel adjacent pipes.

**F. Ferrous Piping:** Ferrous piping material shall only be connected to dissimilar piping materials through an electrical waterway such as a dielectric fitting, union, joint, or coupling that is in compliance with applicable codes and compatible with pipe materials on both sides as well as the liquid being conveyed through the pipe.

### 6.3.9.3 Hanger and Support

**A. Applicable Codes and Standards:** Material and application of pipe hanger and support shall conform to the latest requirement of ANSI/ASME B31.1 or ANSI/ASME B31.9 and Manufactures Standardization Society (MSS) Standard Practice SP-58, SP-69, and SP-89, and appropriate Master Specifications and federal specifications where applicable. All materials and anchorage methods for installations in Seismic Zones 3 and 4 shall comply with local building code requirements, and shall utilize materials and methods approved by the local agency having jurisdiction. Hangers in close proximity, on different service lines, running parallel with each other, shall be in line with each other and parallel to the building structure. Hangers shall be:

1. Spaced to prevent sagging and permit proper pipe drainage
2. Spaced not more than 2.4 m (8 ft.) apart, unless a greater spacing is specifically designed

3. Placed within 300 mm (1 ft.) of each horizontal elbow

**B. Vertical Pipe Support :** Vertical runs of pipe and conduit less than 4.6 m (15 ft.) long shall be supported by hangers placed 300 mm (1 ft.) or less from the elbows on the connecting horizontal runs. Vertical runs of pipe and conduit over 4.6 m (15 ft.) long, but under 18.3 m (60 ft.) long, and not over 150 mm (6 in.) in size, shall be supported by heavy steel clamps.

1. Clamp shall be bolted tightly around the pipes and conduits and shall rest securely on the building structure without blocking.
2. Clamp may be welded to the pipes and placed below coupling.

**C. Trapeze Hanger:** In lieu of individual hangers, multiple trapeze hangers for accessible piping shall be considered for both water pipes and electrical conduit which have the same elevation and slope. Each multiple hanger shall be designed to support a load equal to the sum of the weight of the pipes, conduit, wire, water, and the weight of the hanger itself plus 90 kg (200 lb). The structural engineer shall approve the structural loads caused by the installation of large-diameter piping 200 mm (8 in.) and larger. The safety factor shall be in accordance with ANSI/ASME B31.1. Loading on anchor shall not exceed 25% of the proof-load test. The size of the hanger rod shall be such that the stress at the root of the thread shall not be over 68,950 kPa (10,000 psi) at the design load. No rod shall be smaller than 9 mm (3/8 in.). The size of the horizontal members shall be such that the maximum stress shall not be over 103,425 kPa (15,000 psi) design load. Where vertical piping is specified to extend through sleeves, the riser clamp or pipe support shall transverse the sleeve directly to the structure. Trapeze hangers supporting large-diameter piping, 200 mm (8 in.) and larger, shall be placed to load joists at top panel points only.

**D. Pipe Movement:** Roller-type pipe support shall be specified where significant horizontal pipe movement will occur as a result of thermal expansion, and spring-type support shall be specified where significant vertical movement will occur and where vibration isolation is critical.

**E. Plastic Piping:** Plastic piping shall be supported to permit proper movement and prevent stresses from expansion and contraction, as well as to protect piping from damage due to abrasion.

**F. Fireproofing:** Fireproofing shall not be damaged by the installation of any hanger or attachment. Where existing fireproofing is disturbed, it shall be restored to the satisfaction of the Division of the Fire Marshal (DFM).

### 6.3.9.4 Thermal Expansion

Steam, condensate, and other hot-service piping shall be designed with loops, bends, expansion bellows, anchors, pipe guides and offsets to allow for thermal expansion and keep pipe stresses within the allowable limits of the piping material.

**A. Loops:** Loops or bends may be hard pipe or flexible depending on availability of space. Flexible metal hose is suitable for copper tubing and at branch connection risers.

**B. Expansion Bellows:** Expansion bellows or joints may be provided where movements are too large to accommodate pipe bends or loops, such as piping in tunnels. Expansion joints or bellows shall be installed, anchored and guided in accordance to manufacturer's recommendations. Thrust restraints shall be specified to prevent pipe blow-out or joint separation.

**C. Slip and Ball Joints:** Slip and ball joints shall be avoided because of high maintenance due to frequently replacing packing.

**D. Pipe Riser Expansion:** For vertical pipes subject to expansion and contraction, spring coils or expansion joints shall be used in conjunction with anchors and pipe guides to support and isolate the pipe from the structure.

### 6.3.9.5 Welding

Welding shall conform to current standards and recommendations of the National Certified Pipe Welding Bureau and all OSHA, state protection, and NFPA standard 241 requirements.

**A. Welding of Hydronic Piping:** Welded valves used in the main campus distribution systems and all pipe connections (both butt-weld and socket-weld types) shall conform to ASME B31.9. Butt-welded fitting shall conform to ASME B16.9. Socket-welded fitting shall conform to ASME B16.11. Welded fitting shall be identified with the appropriate grade and marking symbol.

**B. Welding of Steam and Steam Condensate Piping:** Preparation, cleaning, and welding of joint piping, butt welds, fillet welds, bends, loops, and offsets shall be in accordance with ASME B31.1. Welds shall be visually examined and meet acceptance standards indicated in Chapter VI of ASME B31.1. Quality of weld, correction of defects, stress relieving, and preheating shall be in accordance with ASME B31.1. Steam piping systems with operating pressure 138 kPa (20 psi) or less and associated condensate piping may be welded in conformance to ANSI B31.9. Arc welding and gas welding shall be in accordance with ASME BPVC SEC IX.

**C. Brazing and Soldering:** Brazing and soldering procedure qualification shall conform to ASME B31.1. The brazing procedure for joints shall be as outlined in Copper Development Association (CDA) A4015. Soldering, soldering preparation, and procedures for joints shall be in accordance with ASME B31.1 and as outlined in the CDA A4015.

#### 6.3.9.6 Piping and Equipment Identification

**A. Identification System:** All mechanical and electrical equipment and systems shall be provided with a complete identification system that conforms to the requirements published in ANSI/ASME standard A13.1 and NFPA 99. All control devices, i.e., panels, switches, starters, pushbutton stations, relays, temperature controls, etc., shall be clearly identified as to their function and the equipment controlled. Equipment/valve identification and numbering shall be coordinated with the NIH maintenance staff. Any building system carrying potential biohazard contaminated air, water etc. (exhaust air, waste, vent, etc.) needs to be identified with the International Biohazard Symbol signage.

**B. Color Coding:** In existing buildings, identification systems need to match any existing identification system. The A/E shall verify the actual color configuration used in the existing building during the design phase of the project.

**C. System Specific Identification:** Identification shall be system specific, i.e., “Potable or Domestic Cold Water,” “Industrial or Laboratory Cold Water,” “Plant Air,” etc. In no case shall piping be identified with generic terms, i.e., “cold water,” “hot water,” etc. Each laboratory water outlet shall be provided with a laminated identification sign that reads “Laboratory Water – Do

Not Drink”. Similar signage shall be provided for use at ice machines in laboratories and water faucets on non-potable water systems.

**D. Routine Service Items:** Where items requiring routine service are concealed above ceilings or behind access doors, a suitable and visible label shall be attached to the surface to identify the location of such items.

**E. Equipment Markers:** Equipment markers shall be provided for all equipment such as pumps, fans, VAV boxes, fan coil units, heaters, AHUs, boilers, chillers, etc. Equipment markers shall clearly identify the equipment and space or function they serve. Equipment markers shall consist of engraved, laminated, and black-and-white phenolic legend plates. White letters shall be at least 19 mm (0.75 in.) high on a surrounding black plate.

**F. Piping Label:** Piping labels shall consist of colored, prerolled, semirigid plastic label with black letters set around pipe with a field-installed, high-strength cement compound applied along the longitudinal edge. Piping labels shall have 13 mm (0.5 in.) high black letters for pipes smaller than 25 mm (1 in.) and, at least, 19 mm (0.75 in.) high letters for pipes 25 mm (1 in.) and larger. Piping labels shall include flow arrows.

**G. Piping Label Placement:** Piping labels shall be placed around each pipe, with or without insulation, every 9 m (30 ft.). Additional piping labels shall be placed within a room smaller than 4.5 m (15 ft.), and on each side of a wall or floor penetration. Additional pipe labels shall be placed within 2 m (6 ft.) of every major pipe valve, every connected piece of equipment, and at the point where the piping enters every floor.

**H. Valve Tags:** Valve tags shall be provided for all valves. Valve tags shall consist of colored plastic, brass, or aluminum valve tags with stamped-in numbers. Tags shall be secured to the valve with a metal chain. Valve tags are not required on shut-off valves for individual fixtures or equipment where their function is obvious, or where the fixture or equipment is immediately adjacent. Valve tags shall be round, of at least 38 mm (1.5 in.) in diameter with white text indicating the associated system and the valve number. Provide labels and identification at ceiling when valves are in concealed spaces above.

A valve chart shall be provided at the end of each project.

# Exhibit 6.3

Piping Designation, Material, Fittings, and Joints

Line Item	Pipe Service <sup>1, 6</sup>	Service Designation Abbreviation <sup>25</sup>	Color Code <sup>25</sup>	Pipe Material Type	Pipe Fitting Type	Pipe Joint Type
1.	General sanitary waste and vent (except for kitchen, lab, and animal area waste)	SAN, V	White on Green			
a.	Above and below ground waste/vent – 375 mm (15 in.) and smaller (except kitchen or grease waste)			A <sup>2</sup>	I	a <sup>23</sup>
				B <sup>2</sup>	II	a <sup>23</sup>
				D	IV	c <sup>23</sup>
				Q <sup>3</sup>	VIII	e
b.	Above ground applications only, waste/vent – 300 mm (12 in.) and larger			C	III	u <sup>5</sup> , v <sup>5</sup> or jj
c.	Below ground applications only, waste/vent – 300 mm (12 in.) and larger			C	III	b, jj
d.	Vent applications only	V or SAN V		A/B	I/II	a
				D	IV	c, d
				Q	VIII	e
e.	Above-ground trap arms and indirect waste			D	IV	c
				Q <sup>3</sup>	VIII	e
f.	Sanitary trap primer lines	TP or TPL		Q, R	XVIII	e, L
g.	Pumped sanitary waste above and below ground – 100 mm (4 in.) and smaller	PSAN		Q	XVIII, VIII	e
h.	Pumped sanitary waste above and below ground – 100 mm (4 in.) and larger	PSAN		C	III	u <sup>5</sup> , v <sup>5</sup> , jj, b <sup>23</sup>
i.	Pumped sanitary waste above-ground applications only, all sizes	PSAN		AA	IX	k
j.	Sanitary laterals outside building to point of connection with site sewer, (where subject to unavoidable extreme trench loads)			C	III	b, jj
k.	Vapor vents from oil interceptors	V V		D	IV	kk
l.	Autoclave and other high-temperature (potentially above 180°F), non-corrosive waste (including units with after coolers) to point of dilution or natural cooling to below 160°F under aftercooler failure sustained discharge conditions	SAN		D	IV	kk
				Q	VIII	e
2.	Kitchen/Major Foodservice waste, soda-fountain and grease waste	SAN and GW (as applicable)	White on Green			
a.	Underground and above-ground waste and vent, except exposed trap arms in food service areas			PP <sup>40</sup>	XXXVII	m, o
				B <sup>2, 8</sup>	II	a <sup>23</sup>
				37	37	37

Line Item	Pipe Service <sup>1, 6</sup>	Service Designation Abbreviation <sup>25</sup>	Color Code <sup>25</sup>	Pipe Material Type	Pipe Fitting Type	Pipe Joint Type
b.	Above-ground accessible waste applications (except exposed trap arms in food service areas) and vent applications only			A <sup>8</sup>	I	a <sup>23</sup>
				D <sup>8</sup>	IV	c <sup>23</sup>
c.	Above-ground vent applications only			Q	VIII	e
				F/G	VI/VII	i
d.	Above-ground exposed waste, traps, and trap arms (in finished food service areas)			Q <sup>3</sup>	VIII	e
				F	VI	i
3.	Laboratory Waste/cage wash/animal area/photo processing and spaces subject to corrosive detergents and general Corrosion-Resistant Waste and Vent	LW, CRW, LV, CRV	White on Green			
a.	Underground and above-ground waste and vent			PP <sup>4, 40, 10</sup>	XXXVII	m, p
b.	Underground applications only, waste and vent, except potential high temperature waste			H	X	o <sup>38</sup> ,
				BB	LI	m, p
c.	Above-ground applications only, waste and vent, except potential high temperature waste			J <sup>9</sup>	XI	n
				I <sup>9</sup>	XII	m, o <sup>38</sup> , p
d.	Laboratory waste from cage wash equipment, sterilizers, and other equipment with potential high-temperature discharge (above 180°F) to point of dilution or natural cooling to below 160°F (including equipment with aftercoolers) under condition of aftercooler failure sustained discharge			J <sup>9</sup>	XI	n
				PP <sup>4,10, 40</sup>	XXXVII	m, p
e.	Lab/corrosion-resistant waste trap primer lines	TP or TPL		FF	XIII	q
f.	Pumped corrosive/lab waste	PCRW		PP	XXXVII	m, p
g.	Corrosive/lab indirect waste			I, FF, K, L	XIII	q
h.	Waste From Animal Holding Areas, See Note <sup>11</sup>			-	-	-
4.	Biohazardous waste and vent: See Note <sup>12</sup>		Black on Orange	-	-	-
5.	Storm Drain/Clear Water Waste/Clear Water Vent, Storm Sump Pump & Vent and similar	SD, CWW, Storm	White on Green			
a.	Gravity above and below ground – 375 mm (15 in.) and smaller			A <sup>2</sup> ,B <sup>2</sup>	I,II	a <sup>23</sup>
				D	IV	c <sup>23</sup>
b.	Gravity above ground applications only – 300 mm (12 in.) and larger			O	XVI	u <sup>5</sup> ,v <sup>5</sup> or jj



Line Item	Pipe Service <sup>1, 6</sup>	Service Designation Abbreviation <sup>25</sup>	Color Code <sup>25</sup>	Pipe Material Type	Pipe Fitting Type	Pipe Joint Type
c.	Gravity Below ground applications only, – 300 mm (12 in.) and larger and Pumped Below Ground –100 mm (4 in.) and larger			O	XVI	b <sup>23</sup> , jj
d.	Gravity above-ground applications only			Q	VIII	e
e.	Pumped above and below ground – 100 mm (4 in.) and smaller	PSD, PD		Q	VIII, XVIII	e
f.	Pumped above ground applications only, – 100 mm (4 in.) and larger	PSD, PD		O	XVI	u <sup>5</sup> , v <sup>5</sup> or jj
g.	Pumped above-ground applications only, – all sizes	PSD, PD		AA	IX	k
h.	Storm sewer laterals outside building to point of connection with site sewer subject to vehicular or extreme trench loads.			O	XVI	b, jj
6.	Subsurface Drainage/Foundation Drain/ Subsoil Drainage <sup>24</sup>	SSD	N/A	SS	XXXIX	LL
				P	XVII	s
				QQ	XIV	f, LL
7.	Condensate Drain (from cooling coil/drain pans) above ground (non-acidic), and similar indirect waste	CD or IW	White on Green	Q	VIII	e, j
				AA	IX	k
8.	Incoming Combined Water Service/Domestic Water Service/Fire Water Service (to BFP)	W, DW, FS	White on Green (White on Red for fire)			
a.	Above-ground applications only, – 65 mm (2.5 in.) through 100 mm (4 in.)			T	XVIII	L
b.	Above-ground applications only, – 75 mm (3 in.) and larger			V	XIX	u <sup>13</sup> , v, jj
c.	Underground applications only, – 75 mm (3 in.) and larger			X <sup>15</sup>	XXI <sup>15</sup>	t <sup>15</sup>
d.	Underground applications only, – 75 mm (3 in.) and smaller			U	XVIII	L <sup>14</sup>
9.	Domestic Cold Water	DCW	White/Gr			
	Laboratory Cold Water	LCW	Blk/White			
	Make-up water for closed loop systems and Process, and Nonpotable cold water	NPC	Blk/Yell			
	Domestic Hot Water/Return	DHW, DHWR	White/Gr			

Line Item	Pipe Service <sup>1, 6</sup>	Service Designation Abbreviation <sup>25</sup>	Color Code <sup>25</sup>	Pipe Material Type	Pipe Fitting Type	Pipe Joint Type
	Laboratory Hot Water/Return	LHW, LHWR	Blk/White			
	Process, and Nonpotable Hot Water/Return	NPH, NPHR	Blk/Yell			
a.	Above-ground applications only, – 65 mm (2.5 in.) and smaller			Q	XVIII	e
				Z	XXIII	k
b.	Above-ground applications only, – 75 mm (3 in.) through 100 mm (4 in.)			Q, T	XVIII	L
c.	Above-ground applications only, – 100 mm (4 in.) through 150 mm (6 in.)			T	XVIII	L
d.	Above-ground cold water applications only, – 100 mm (4 in.) and larger			V	XIX	u <sup>13</sup> , v, jj
e.	Above-ground applications only, 65 mm (2.5 in.) and larger			TT <sup>36</sup>	XXII	x <sup>13</sup>
f.	Above-ground applications only, 150 mm (6 in.) and larger			TT <sup>36</sup>	XX	n n
g.	Above-ground applications only, 100 mm (4 in.) and smaller			Y <sup>36</sup>	XL	j <sup>32, 33</sup>
h.	Above-ground applications only, – 40 mm (1.5 in.) and smaller <sup>31</sup>			Q, T	XLI	j <sup>32, 33</sup>
i.	Above-ground applications only, – 40 mm (1.5 in.) and smaller			Q, T	-	mm <sup>34</sup>
j.	Underground applications only, – 65 mm (2.5 in.) and smaller			U	XVIII	L <sup>14</sup>
k.	Accessible Connections and Fixture Supplies, 20 mm (0.75 in.) and smaller, additional option			U	XXIII	ii
10.	Purified Animal Drinking Water	ADW	White on Green			
a.	Aboveground applications only			CC	XXV	z, n n
				N <sup>42</sup>	XXIV	aa, m <sup>43</sup> , p <sup>43</sup>
b.	Aboveground readily accessible or exposed applications only			CC	XXV	w
				N <sup>42</sup>	XXIV	w
11.	High-Purity Water Supply and Return, (including RO, Distilled, and UHP Water)	HPWS/HPWR <sup>16</sup>	White on Green			
a.	All applications, including ozonated, except not approved for WFI			EE	XXXII	aa

Line Item	Pipe Service <sup>1, 6</sup>	Service Designation Abbreviation <sup>25</sup>	Color Code <sup>25</sup>	Pipe Material Type	Pipe Fitting Type	Pipe Joint Type
b.	All applications not using ozone for sanitization, except not approved for WFI			UU <sup>1, 27</sup>	XXVI	aa
c.	Make-up water to production equipment for high purity lab water (upstream of RO)			DD <sup>1, 27</sup>	XLII	aa,
				UU <sup>1, 27</sup>	XXVI	m, p
d.	Low grade local RO water for scale control applications;  RO feed water to stills or to steam/clean steam humidification (except feed for pure steam);  Make-up water to treatment equipment used to produce purified water for boiler makeup, scale control applications, or low grade applications (not for systems producing purified water to be distribution to labs), prior to RO membrane	RO/Purified Feed Water (or similar)		DD <sup>1, 27</sup>	XLII	aa,
				UU <sup>1, 27</sup>	XXVI	m, p
				L	XLIII	f
e.	WFI; High Temperature purified water; Ozonated applications; and applications where stainless is otherwise justified for high purity water	WFI (or spell out as applicable)	White on Green	W	XLIV	y
f.	Tubing Connecting Water Polishers and equipment			V-V	XLV	oo
12.	<b>Chilled Water Supply and Return, Above Ground Applications Only (including within service tunnels)<sup>47</sup></b>	CHWS/CHWR	White on Green			
a.	650 mm (26 in.) and larger			MM	XXIX	r
b.	300–600 mm (12–24 in.)			JJ	XXIX	r
c.	65–250 mm (2.5–10 in.)			II	XXIX	r, pp
d.	100 mm (4 in.) and smaller			II <sup>41</sup>	XLVI	qq
				Q	XVIII	L
e.	65 mm (2.5 in.) and smaller			Q	XVIII	e
f.	40 mm (1.5 in.) and smaller <sup>31</sup>			Q, T	XLI	j <sup>33</sup>
					-	mm <sup>34</sup>
g.	50 mm (2 in.) and smaller			II, WW	XXVIII	k
h.	Underground (Direct Bury) Applications, All Sizes, Approved Variance Required <sup>44</sup>			HHH <sup>45</sup>	-	-
				X <sup>45, 46</sup>	XXI	t
				FFF <sup>45, 46</sup>	XLVIII	t
13.	<b>Glycol Water Supply and Return</b>	GWS/GWR	White on Green			

Line Item	Pipe Service <sup>1, 6</sup>	Service Designation Abbreviation <sup>25</sup>	Color Code <sup>25</sup>	Pipe Material Type	Pipe Fitting Type	Pipe Joint Type
a.	65 mm (2.5 in.) and larger			II	XXIX	r, pp
b.	50 mm (2 in.) and smaller			II	XXVIII	k
c.	100 mm (4 in.) and smaller			II <sup>41</sup>	XLVI	qq
				Q	XVIII	L
d.	65 mm (2.5 in.) and smaller			Q	XVIII	e
14.	<b>Condenser Water Supply and Return; Above Ground Applications (including within service tunnels)</b>	CWS/CWR	White on Green			
a.	All Sizes, preferred material			XX <sup>45</sup>	XLVII	v
b.	650 mm (26 in.) and larger			MM <sup>16</sup>	XXIX	r, pp
c.	300 mm (12 in.) and larger			JJ <sup>16</sup> , WW <sup>16</sup>	XXIX	r, pp
d.	65–250 mm (2.5–10 in.)			WW <sup>16</sup>	XXIX	r, pp
e.	50 mm (2 in.) and smaller			T	XVIII	e
f.	Underground, All Sizes; Approved Variance Required <sup>44</sup>			FFF <sup>45</sup>	XLVIII	t
15.	<b>Cooling Water Supply and Return (including non-sanitary process cooling); Above Ground Applications Only (including within service tunnels)<sup>47</sup></b>	CS/CR PCS/PCR	White on Green			
a.	125 mm (5 in.) and larger			II	XXIX	r, pp
b.	Reserved / Not Used					
c.	100 mm (4 in.) and smaller			II <sup>41</sup>	XLVI	qq
				Q	XVIII	L
d.	65 mm (2.5 in.) and smaller			Q	XVIII	e
e.	40 mm (1.5 in.) and smaller <sup>31</sup>			Q, T	XLI	j <sup>33</sup>
					-	mm <sup>34</sup>
f.	50 mm (2 in.) and smaller			II, WW	XXVIII	k
g.	Flex Connectors for Chilled Beams			YY	-	-
16.	<b>Heating Water Supply and Return and Heat Recovery Supply and Return; Above Ground Applications Only (including within service tunnels)</b>	HWS/HWR	White on Green			
a.	300 mm (12 in.) and larger			JJ	XXIX	r
b.	65–250 mm (2.5–10 in.)			II	XXIX	r, pp
c.	100 mm (4 in.) and smaller			II <sup>41</sup>	XLVI	qq
				Q	XVIII	L

Line Item	Pipe Service <sup>1, 6</sup>	Service Designation Abbreviation <sup>25</sup>	Color Code <sup>25</sup>	Pipe Material Type	Pipe Fitting Type	Pipe Joint Type
d.	65 mm (2.5 in.) and smaller			Q	XVIII	e
e.	40 mm (1.5 in.) and smaller <sup>31</sup>			Q, T	-	mm <sup>34</sup>
f.	50 mm (2 in.) and smaller			WW	XXVIII	k
g.	Flex Connectors for Chilled Beams			YY	-	-
h.	Underground, All Sizes; Approved Variance Required <sup>44</sup>			GGG	-	-
17.	<b>Steam Supply, 1,200 kPa (175 psi) Maximum; Above Ground Applications Only (including within service tunnels)</b>	HPS/MPS/LPS	Black on Yellow			
a.	300 mm (12 in.) and larger, all pressures			LL	XXIX	r
b.	Sizes 250 mm (10 in.) and smaller; all pressures			KK	XXIX	r
c.	50 mm (2 in.) and smaller			KK	XXXV	rr
d.	50 mm (2 in.) and smaller, except high pressure; 25 mm (1 in.) and smaller for high pressure			LL	XXVIII XXXIV	k
e.	50 mm (2 in.) and smaller, low pressure applications only			KK	XXVIII XXXIV	k
f.	100 mm (4 in.) and smaller, low pressure applications only			KK <sup>41</sup>	XLVI	qq
g.	Underground, All Sizes; Approved Variance Required <sup>44</sup>			GGG	-	-
18.	<b>Steam vents</b>	SV	Black on Yellow			
a.	65 mm (2.5 in.) and larger			KK, ZZ	XXIX	r
b.	50 mm (2 in.) and smaller			KK, ZZ	XXVIII XXXIV	k
c.	50 mm (2 in.) and smaller			KK, ZZ	XXXV	rr
					XXIX	pp
d.	100 mm (4 in.) and smaller			ZZ <sup>41</sup>	XLVI	qq
19.	<b>Steam Condensate (gravity return); Above Ground Applications Only (including within service tunnels)</b>	HPR/MPR/LPR	Black on Yellow			
a.	65 mm (2.5 in.) and larger			LL	XXIX	r
b.	50 mm (2 in.) and smaller			LL	XXVIII	k
					XXXIV	k
					XLVI	qq <sup>41</sup>
					XXIX	r
					XXXV	rr <sup>50</sup>

Line Item	Pipe Service <sup>1, 6</sup>	Service Designation Abbreviation <sup>25</sup>	Color Code <sup>25</sup>	Pipe Material Type	Pipe Fitting Type	Pipe Joint Type
c.	Underground, All Sizes; Approved Variance Required <sup>44</sup>			GGG	-	-
20.	<b>Pumped Steam Condensate</b>	PC	Black on Yellow			
a.	Above ground applications only (including within service tunnels); all sizes			LL	XXIX	r
b.	Above ground applications only, sizes 50 mm (2 in.) and smaller			LL	XXIX	r
					XXXV	rr
c.	Above ground applications only, sizes 25 mm (1 in.) and smaller			LL	XXVIII	k
d.	Underground, All Sizes; Approved Variance Required <sup>44</sup>			GGG	-	-
21.	<b>Oxygen (gaseous)</b>	Oxygen Medical Oxygen Veterinary Med Oxygen (As applicable)	White on Green			
a.	Above-ground			GG	XXVII	bb
b.	Underground			HH <sup>18</sup>	XXVII	bb
22.	<b>Nitrogen (gaseous, noncryogenic)</b>	N <sub>2</sub> (pressure range and application Lab, Medical, etc.)	White on Black			
a.	Standard pressure			GG	XXVII	bb
				RR	XLIX	qq
b.	High pressure, 1,000 to 1,380 kPa (150 to 200 psi) <sup>48</sup>	(indicate pressure range)		HH	XXVII	bb
				S	XXXVI	bb
				RR	XLIX	qq
c.	Above 1,034 kPa (150 psi) <sup>48</sup>			RR	XV	r, y, z
23.	<b>Nitrous Oxide</b>	N <sub>2</sub> O	White on Blue	GG	XXVII	bb
24.	<b>Carbon dioxide (gaseous, noncryogenic); 1,034 kPa (150 psi) or less</b>	CO <sub>2</sub>	Black on Gray			
a.	Above-ground			GG, HH	XXVII	bb
				S	XXXVI	bb
				RR	XLIX	qq
b.	Underground			HH <sup>18</sup>	XXVII	bb



Line Item	Pipe Service <sup>1, 6</sup>	Service Designation Abbreviation <sup>25</sup>	Color Code <sup>25</sup>	Pipe Material Type	Pipe Fitting Type	Pipe Joint Type
25.	Argon, inert gasses, and CO <sub>2</sub> /air/oxygen mixtures, except ultra high purity (UHP); 1,034 kPa (150 psi or less)		White on Purple	GG	XXVII	bb
				RR	XLIX	qq
				RR	XV	y <sup>26</sup> , z <sup>26</sup>
26.	Medical air and Veterinary Medical Air	MA/Veterinary Med Air	Black on Yellow	GG	XXVII	bb
27.	Medical Vacuum and Veterinary Medical-Surgical Vacuum	MV/Veterinary Surg. Vac	Black on White	GG	XXVII	bb <sup>35</sup>
				RR	XLIX	qq
28.	Laboratory Air	LA, LA-(110) (pressure)	White on Blue	GG	XXVII	bb
				S	XXXVI	bb
				RR	XLIX	qq
29.	Laboratory Vacuum	LV	White on Black	GG	XXVII	bb <sup>35</sup>
				Q	XVIII	L <sup>35</sup>
				RR	XLIX	qq
				RR	XV	y, z
30.	Lab Gas/Compressed Gas Applications, Final Connections Alternative; Grade 4.5 or Lower Purity and Standard Lab Vacuum Only		n/a	RR <sup>29</sup> HH <sup>29</sup>	XXXVIII	dd
31.	Waste Anesthetic Gas Disposal and Veterinary Anesthetic Gas Scavenging	WAGD/AGSS	White on Purple	Q	XVIII	L
				GG	XXVII	bb
				RR	XLIX	qq
32.	Ultrapure (UHP)/special lab gasses; NMR Cryoprobe Helium; Gas Chromatography Columns; Analyzer Lines; and Small Molecule Gases (e.g., Helium)		White on Purple	AAA	L	y cc
33.	Hazardous Gasses/Fluids (not otherwise addressed)		Black on Orange	Note 28	Note 28	Note 28
34.	Fuel Oil Supply/Return Fuel Oil Vent	FOS/FOR FOV	Black on Yellow			
a.	65 mm (2.5 in.) and larger			II	XXIX	r
b.	50 mm (2 in.) and smaller			II	XXVIII	rr
35.	Natural Gas (and also LPG below 14 kPa (2 psi) where permitted for remote sites)	G (for ~1.7 kPa (~7 in. w.g.); G-2 psi, (for 14 kPa); G-5 psi (for 34 kPa)	Black on Yellow			

Line Item	Pipe Service <sup>1, 6</sup>	Service Designation Abbreviation <sup>25</sup>	Color Code <sup>25</sup>	Pipe Material Type	Pipe Fitting Type	Pipe Joint Type
a.	Above-ground – 14 kPa (2 psi) and less, size 65 mm (2.5 in.) and smaller			II <sup>20</sup>	XXVIII	k
b.	Above-ground – 14 kPa (2 psi) and less, size 65 mm (2.5 in.) and larger			II <sup>20</sup>	XXIX	r, pp
c.	Above-ground – 14 kPa (2 psi) and higher, all sizes.			II <sup>20</sup>	XXIX	r, pp
d.	Above-ground, 35 kPa (5 psi) and less, size 50 mm (2 in.) and smaller			II <sup>20</sup>	XXXV	rr
e.	Underground – outside building (interior underground piping not permitted)			NN	XXX	hh
f.	Exposed fume hood and laboratory equipment connections			II	XXVIII	k
				RR	XLIX	qq
				RR, OO	XXXVIII	dd <sup>30</sup>
36.	General Compressed air, 1,034 kPa (150 psi) and less, (including control air) <sup>21, 48</sup>	CA, A(xx) (pressure)	White on Blue	GG/HH	XXVII	bb
				S	XXXVI	bb
				RR	XLIX	qq
				RR	XXXVIII	dd <sup>29</sup>
				RR	XV	r, y, z
	Non-sensitive/dirty applications only (e.g., shop air). Not acceptable for lab air or contaminant-sensitive controls applications			Q, T	XVIII	L
37.	Dental vacuum (oral suction only) (Above-ground and underground)	DV	Blk/Wh diago- nal on Blk	Q	VIII	e
				K, L	XIV	f
38.	Refrigerant Piping	RS/RL	Black on Yellow			
a.	Class A1 Refrigerants, high and low pressure side and compatible with Copper Tubing; Sizes 2.625 in. and smaller			S	XXXVI	ff
b.	Class A1 Refrigerants, high and low pressure side; Sizes 0.625 in. and larger			RR	XLIX	qq
					XV	r <sup>26</sup> , y <sup>26</sup> , z <sup>26</sup>
c.	Class A1 Refrigerants, low pressure side only; and compatible with Copper Tubing			S, GG	XVIII, XXXVI	ff
39.	Refrigerant Relief, Class A1 Refrigerants	RR	Black on Yellow	S, GG, T,Q	XXXVI, XVIII	L, ff
				II	XXIX	r, pp

Line Item	Pipe Service <sup>1, 6</sup>	Service Designation Abbreviation <sup>25</sup>	Color Code <sup>25</sup>	Pipe Material Type	Pipe Fitting Type	Pipe Joint Type
40.	Generator Exhaust		n/a	KK, ZZ	XXIX	r
41.	Clean steam (except USP pure steam), 552 kPa (80 psi) or lower	CS	Black on Gray			
a.	Size 65 mm (2.5 in.) to 250 mm (10 in.)			M	XV	r
b.	Size 50 mm (2 in.) and smaller			M	XXXI	rr
42.	Cryogenic Services (e.g., nitrogen, oxygen, helium and including liquid carbon dioxide)	L-(service) (e.g., L-CO <sub>2</sub> )	Black on White	BBB	-	-
<b>SITE UTILITIES</b>						
43.	Exterior Storm Sewer		n/a			
a.	Size 300 mm (12 in.) and larger			CCC <sup>22</sup> O <sup>22</sup>	- XVI	- b <sup>23</sup> , jj
b.	Size 300 mm (12 in.) and smaller			CCC <sup>22</sup> O <sup>19, 22</sup> DDD	- XVI <sup>19</sup> -	- b <sup>23</sup> , jj -
44.	Exterior Sanitary Sewer		n/a			
a.	Size 300 mm (12 in.) and larger			EEE <sup>22</sup> III <sup>22, 17</sup> C <sup>19, 22</sup> LLL <sup>22</sup>	- - - -	- - b, jj p
b.	Size 250 mm (10 in.) and smaller			EEE <sup>17, 22</sup> JJJ <sup>17, 22</sup> C <sup>17, 19, 22</sup> LLL <sup>22</sup>	- - III <sup>19</sup> -	- - b, jj p
c.	Sewer Jacking Piping (Trenchless installation, where permitted)			EEE <sup>22</sup>		
d.	San/Storm Sewer Force Main			C <sup>19</sup> LLL	III <sup>19</sup> -	b, jj p
45.	Underground Water Mains/ Fire Water Mains	W, F	n/a	X <sup>15</sup>	XXI <sup>15</sup>	t <sup>15</sup>
46.	Compressed Air Utility Mains (General Compressed Air); 1,034 kPa (150 psi) and less	CA-(x) (Pressure)				
a.	Aboveground		White on Blue	GG/HH S RR KKK <sup>27, 49</sup>	XXVII XXXVI XV -	bb bb r, y, z -

Line Item	Pipe Service <sup>1, 6</sup>	Service Designation Abbreviation <sup>25</sup>	Color Code <sup>25</sup>	Pipe Material Type	Pipe Fitting Type	Pipe Joint Type
b.	Underground, all sizes; Approved Variance Required <sup>44</sup>			HH	XXVII	bb <sup>14</sup>
				RR	XV	r, y, z
				KKK <sup>49</sup>	-	-
47.	Fuel Gas, Underground Outside Building		n/a	NN <sup>6</sup>	XXX	hh
48.	Chilled Water, Heating Water, Steam, Steam Condensate (see respective section of table above)		-	-	-	-

**General Notes and Referenced Requirements:**

**A.** Multiple materials or joint methods may be acceptable as indicated in these tables, in which case the A/E shall select the best option or allow each as appropriate based on competitive bidding.

**B.** Pipe fitting or joint systems that require use of a proprietary, single manufacturer's piping are not acceptable. All fittings and joint methods used must be compatible with industry standard piping material of the respective type, as produced by multiple manufacturers.

**C.** Where a unique project site condition would make the indicated materials inappropriate, (e.g., local soils condition or other project-specific technical constraint that would uniquely preclude effective service life) the A/E shall alert the PO and obtain direction from DTR. The A/E shall verify soils compatibility per appropriate standards through consultation with the project geotechnical engineer and as otherwise determined necessary. This requirement is especially critical (but not limited) to brownfield sites and sites potentially impacted by contamination or corrosive conditions. Soils testing is mandatory at brownfield and suspected contaminated or corrosive sites, and must at minimum include soils redox, pH, resistivity, chloride, organics, and stray currents at intervals as determined sufficient, to determine compatibility with piping materials prior to specifying materials.

**D.** Piping, fittings, and joints shall be subject to compliance with materials and wall thickness limitations as required due to surge pressures, cyclic stress loadings, thermal and mechanical stress limitations and other restrictions (e.g., environmental and external factors) and corrosion allowances as relevant to the application. Selections shall be made to provide a service life of not less than 50 years. Where a conflict exists between the application technical requirements (e.g., fluid or soils chemistry or working conditions) and the directed materials and joints as indicated in these tables, obtain clarification through the PO. The A/E shall confirm internal and external exposure compatibility for each material application.

**E.** Pipe fittings, flanges, piping, and components working pressure selections shall be applied in consideration of the actual maximum working pressures and the peak temperatures of the system. Derating is often required

to listed working pressures where temperatures are outside the range the component is marked.

**F.** The terms "Above-ground" and "Below-Ground" as used in these tables refer to the application as a buried versus a non-buried piping component.

**G.** Threading and other joint methods which reduce the pipe wall thickness are not permitted for any piping material thinner than Schedule 40 wall thickness. Unless specifically indicated as an approved joint method for the application in these tables, any method which reduces the wall thickness or otherwise reduces system working pressure values shall be justified and require pre-approval.

**H.** Regardless of DRM allowed piping materials, no piping material (especially plastic) may be subjected to loading or deflection greater than as approved by the piping and joint manufacturer. System capability to handle loads, deflection and other stresses shall be fully independent of the system pressurized or non-pressurized status.

**I.** Piping, fittings, and components shall be certified to required standards by a nationally recognized test laboratory or lab accredited by a signatory to the ILAC Mutual Recognition Agreement. Self-certification and certification only of post-manufactured products is not acceptable unless allowed by the required standard or code, or reasonable diligence has occurred by the specifier to ascertain accuracy of compliance claims of the actual manufactured and as-delivered product. Mill certification to the requirements of the governing standard should be provided for piping/fittings, and elastomer certification for the completed, as-supplied elastomeric component (not just the compound); including when these components are parts of vendor-assembled equipment packages. The A/E should specify reputable manufacturers of pipe and fittings with an appropriate quality management system, such as ISO 9000 series standards or equivalent.

**J.** There can be significant differences in service longevity of piping products from various manufacturers and varying product lines. The A/E should be sure piping and fittings are specified and supplied from reliable manufacturers, in full conformance with manufacturing standards (not just required alloy), and special attention to weld processes during manufacturing, inspection, and surface finish and coatings (interior and exterior).

**K.** The A/E shall require contractors to follow necessary precautions during materials handling, installation, testing, and start-up to maintain system cleanliness and protect piping systems from contamination up to final turn-over and acceptance. This includes but is not limited to keeping systems sealed, precluding stagnation, use of only clean and compatible tools, clean storage of materials, and protecting piping interiors from contamination during fabrication. Work shall be performed by personnel qualified in required system construction, joint quality, materials, and cleanliness procedures as required to maintain system fluid quality requirements and prevent premature corrosion or system failure. The use of cleaning solutions and purging processes post installation may be acceptable for some applications, but is not a substitute for diligent handling and installation. Cleaning solutions (where permitted) must be properly flushed from systems immediately and prior to inducing corrosion.

**L.** Risks of premature piping failure due to corrosion under insulation (CUI) shall be considered and addressed by the A/E as appropriate to all metallic piping systems, with particular attention applied to exterior pipe protective coatings, insulation/insulation jacket selection, installation, and sealing for cold systems subject to condensation.

**M.** Transitions between dissimilar materials shall be made in such manner as to protect systems from corrosion. Comply with recommendations of the National Association of Corrosion Engineers (NACE) and the additional recommendations of each respective piping materials industry association (e.g., CDA, DIPRA, Nickel Institute etc.). Where dielectric protection is required, the dielectric fitting shall be installed directly connected to the anodic material without any intervening brass fittings or other materials between the anodic material and the dielectric isolator.

**N.** Elastomers indicated are general requirements. Specific grades of elastomers or variations in curing process may affect elastomer compatibility and purity. The A/E shall review specify appropriate grades of elastomers and review submittals for compatibility with system application and plausible chemical, pressure, temperature, cleanliness/purity and mechanical conditions through reliable data sources (e.g., elastomer manufacturer).

**O.** A sufficient allowance shall be included in the application of piping, fittings, joints and components to address plausible surge pressure without resultant joint failure. Reliance shall not be solely on presence of mechanical devices to control surge pressures. Compliance with ANSI/ASME B31.9 (or B31.1 or B31.3 where applicable) is mandatory for all piping systems. Regardless of piping system pressure ratings, appropriate provisions to control hydraulic shock (e.g., water hammer), thermal movement, external loads, and other stressors based upon engineered analysis is required. Selection of components and joints shall include any required reduction in pressure rating as associated with the joint type or weakening as a result of the joint process (e.g., as due to threading, grooving, application of heat, annealing, flanging etc.).

**P.** Piping hangers and attachments shall be compatible with piping system manufacturer requirements, and the application. Painted or coated hangers and attachments are not acceptable in lieu of compatible materials or durable and effective isolation.

**Q.** Piping shall be avoided above food preparation areas, food storage rooms, aquatics, switchgear, data storage, and surgical areas. Where otherwise unavoidable and piping carries liquids, gravity drainage piping and fittings shall be double-contained by polypropylene double containment of minimum SDR-33 thickness, and heat fusion sealed capable of at least 35 kPa (5 psi). Storm and cold condensate carrier lines shall be insulated. Pressure systems require pressure-rated double containment over insulation with leak detection.

**R.** Methods and materials for wet taps, where permitted by the NIH, shall be submitted for approval by the A/E. Submittals shall include documentation on the products to be used with complete instructions and procedures to ensure successful wet taps. Methods and materials shall maintain required system cleanliness and shall not reduce working pressure ratings or service life.

**S.** Flange bolts / studs, nuts / washers shall be in strict conformance with ASME codes and of appropriate yield strength. Bolting components for uninsulated cold system joint applications or where otherwise susceptible to corrosion shall be Xylan coated, stainless steel, or approved manufactured equivalent. Gaskets shall be manufactured type only, using compatible elastomers



or metals of design specific to the flange type and fluid system application, with bolting materials and torque requirements coordinated. Gasket thickness greater than 3.175 mm (1/8 in.) is generally prohibited.

#### **Additional Requirements, Plastic Systems:**

**A.** ASTM D2837 and manufacturer recommendations shall be used for pressure rating of thermoplastic systems. Plastic piping hydrostatic design basis, hydrostatic design stress, strength design basis, pressure design basis, minimum required strength, and minimum required strength ratings shall be in conformance with the recommendations of the Plastic Pipe Institute.

**B.** Special attention to risks of internal and external permeation, cracking (including environmental stress cracking resistance), effects of UV and materials oxidation, mechanical strength, thermal flexibility, and general age and strength degradation shall be applied in selecting and approving plastic pipe and fitting products.

**C.** Plastic piping is not approved for applications with less than 305 mm (12 in.) of properly constructed backfill, or at depths greater than 6 meters (20 ft.), manufacturers requirements, or 5% calculated deflection (whichever is less).

**D.** A weld inspection and quality assurance program sufficient to ensure joint quality is required for thermoplastic pipe welding (including socket, butt, stick, and electrofusion) for any of the following: (a) Pressurized fuel gas piping; (b) Pressurized or gravity piping systems carrying corrosive or hazardous fluids; (c) Pressurized piping over 100 mm (4 in.) diameter; (d) New facility and major installations of ultra-high purity fluid piping (including purified water systems); (e) Any other applications as directed by the ORF or as determined appropriate by the A/E to help assure proper construction. Where possible, welding inspectors should be PWI (Plastic Weld Inspector) or SPWI (Senior) level, in accordance with AWS G1.6 Specification for Qualification of Plastics Welding Inspectors, and independent of the installing contractor or as otherwise approved by NIH DTR. Independent weld inspection may be waived for fully automatic IR type butt fusion joints in purified water piping systems 100 mm (4 in.) and smaller performed by qualified installers; as well as for accessible sanitary or conventional lab waste piping; provided an otherwise satisfactory quality assurance plan

is provided.

**E.** The use of plastic piping with press joints, push-joints, bite-rings, crimp rings, or similar joints is not acceptable for any pressurized piping system application. In general, plastic piping is only acceptable with fusion type joints provide a molten weld between piping and fitting.

**F.** Co-extruded and other non-solid wall plastic materials are not acceptable.

#### **Additional Requirements, Welded Systems and Stainless Steel Piping Systems:**

**A.** A weld inspection/quality assurance program sufficient to ensure proper fabrication and as otherwise required by ANSI B31.9, ANSI B31.1, ANSI B31.3 and Section IX BPVC (as applicable) shall be provided for all welded pressure and hazardous fluid systems and for all welded stainless steel piping systems. Additionally, certification of proper passivation in conformance with ASTM A380 and ASTM A967 is required for all welded stainless steel systems or where passivation is otherwise required. Weld inspectors and passivators shall be independent of the installing contractor. Subject to any special project requirements or restrictions of code or standards, non-destructive testing shall be performed by ASNT TC-1A Level 2 or greater for the technique employed; Certified Weld Inspectors (AWS CWI/SCWI) are also acceptable subject to competence for the NDT technique; all of which shall have at least 5-years professional experience.

**B.** Stainless steel systems shall be installed in strict conformance with manufacturer requirements and the recommendations of Nickel Institute to preserve the integrity, cleanliness, and corrosion resistance of the system. Use of only dedicated stainless steel-compatible tools used only for work with stainless steel piping, Examples that must be addressed include, but are not limited to protection from ferrous materials and any contact with graphite (including avoiding carbon steel tools, cutters, and brushes; use of only stainless steel wire brushes, protection from grinding debris from other construction activities; avoiding other graphite or carbon steel contact) avoidance of stagnant water conditions; proper storage off ground and with non-absorbent protection; avoidance of chloride contamination, use of only equivalent weld alloys; minimization of field welding; use of only qualified welders/fabricators; permitting

only full-penetration, crevice-free and piping interior-smooth welds; comprehensive post weld examination; qualified passivation procedures and post-passivation protection. Proper protection to maintain the integrity of the stainless steel system shall be rigorously enforced. Failure to conform to these requirements will typically result in need to isolate, pickle, and re-passivate (and certify the effective passivation) of the piping system in conformance with ASTM A967 and ASTM A380; and may result in rejection of the entire piping system installation. A rigorous QA/QC plan should be developed. Post-fabrication descaling and passivation is required for welded stainless steel systems (unless otherwise indicated) and shall include full removal of heat tint in the heat affected zone.

C. Stainless steel piping systems must remain closed/protected from foreign contaminants during construction. Descaling/passivation activities for potable and lab water systems shall be conducted only with fully disconnected and isolated piping systems. Reliance upon closed or locked valves only is unacceptable for potable or lab water systems or for any system constructed of multiple materials where some materials are not fully compatible with the chemical process, or for any system where risk to occupants may occur. Do not allow pickling/passivation solution to enter any portion of piping system except that compatible with and intended to be treated. All pickling/passivation process conducted in occupied facilities shall include submission of a process, safety, and risk mitigation plan and pre-approval from the NIH PO.

#### **Keyed Notes:**

<sup>1</sup> PPr (random copolymer polypropylene) shall not be directly connected to copper due to potential accelerated failure.

<sup>2</sup> Hub may be cut off below ground and hubless pipe extended above grade with appropriate transition adapter to above-ground material. (This allows pipe to fit in standard walls and chases.)

<sup>3</sup> Copper pipe is not acceptable for drainage from urinals, blood analyzers, or any corrosive wastes. It may be used for trap arms from sinks in kitchens, but it is not acceptable for waste piping from floor drains or floor sinks that are located in kitchens.

<sup>4</sup> PVDF not approved for waste from alkaline hydrolysis tissue digesters.

<sup>5</sup> Flanged joints, groove joints, and shoulder joints are not permitted for underground applications.

<sup>6</sup> Fusion-welded anodeless risers required.

<sup>7</sup> Where caulked joints are utilized, the interior of piping mains shall be inspected by video camera and demonstrate that joints have been properly made without resultant joint packing material extending into piping interior prior to concealment or backfill.

<sup>8</sup> Do not use this material for waste lines from soda fountains, carbonated waste, or strong chemicals Use any of the approved lab waste materials per these tables to the point of connection to a main line that is arranged to provide adequate dilution downstream from frequently used flushing fixtures. Solid wall PVC with solvent cemented/primer joints may also be used for this application for buried piping that is not receiving any potentially high temperature waste (e.g., dishwashers, steamers, kettle drains).

<sup>9</sup> Glass shall not be used for vents through a roof. Avoid use of glass for photo-processing waste floor drain traps as it could allow light transfer into space. Glass is not permitted for buried piping.

<sup>10</sup> Polyvinylidene fluoride (PVDF) should not be used for highly caustic wastes. It is acceptable for drainage from cage wash equipment where equipment is fitted with internal pH neutralization and appropriate flexibility analysis.

<sup>11</sup> The use of all DRM approved lab waste materials is required for waste from animal holding rooms; and additionally solid wall ASTM D2665 virgin PVC with 2-step ASTM F656 primer and ASTM D2564 solvent cement may be used below ground for some applications with approval. The use of such materials provide increased resistance to various concentrated ammonia/urines, acids, cleaners and disinfectants compared to common metallic piping systems and is therefore required even for applications not requiring waste treatment prior to discharge to sewer. Plastic piping is not permitted to be exposed within reach of animals or subject to mechanical damage (e.g., rack movement). Cellular core or coextruded piping is not acceptable. The use of corrosion-resistant materials for waste from animal rooms is not restricted to areas connected only to pH neutralization. Where piping cannot be satisfactorily concealed or protected, alternative materials (e.g.,

epoxy coated ductile iron, or stainless steel are typically required.

<sup>12</sup> Refer to Section 8.6 BSL-3 and ABSL-3 Biocontainment. Biowaste systems and associated effluent treatment are generally not used for BSL-3 laboratories. All biowaste piping outside containment to include a heat-weldable/fusible double containment and automatic low point leak detection. Biowaste systems typically require approved welded primary carrier materials (for example schedule 10 Hastelloy C22 is generally required for applications where chlorine may be present); and welds for systems must be crevice free, complete joint penetration, ASME BPE type, and with a smooth inner bore. In some cases special alloy stainless may be permitted. For limited applications (e.g., systems where chemical treatment is acceptable and with no hot wastes), welded PVDF constructed as a pressure-rated system may be permitted on a project specific basis.

<sup>13</sup> Grooved joints in domestic/lab/non-potable and process water systems shall only be permitted where the joints are located to be accessible. Not permitted for pressurized piping system sizes larger than 250 mm (10 in.).

<sup>14</sup> No joints are permitted below building slab.

<sup>15</sup> For slab on grade foundation applications where a pipe joint cannot be avoided, only a single fitting (e.g., two joints) may occur under the building slab, piping shall not run under the slab more than 5 ft., the joint shall be provided with a manufactured ductile iron restraint constructed of ductile iron, thrust blocs are additionally required, and the joint encased. The pipe and fittings for this application shall include an exterior fusion bonded epoxy coating by the manufacturer, in addition to the encasement.

<sup>16</sup> Suitability of bare steel piping is highly dependent upon proper chemical monitoring and maintenance. Alternative materials (e.g., lined ductile iron) are preferred due to lower susceptibility to tuberculation and corrosion while maintaining mechanical strength, chemical, UV, thermal cycling, and materials degradation (e.g., stress cracking and embrittlement) resistance.

<sup>17</sup> Fitting interior bore to be selected to match piping internal diameter/invert.

<sup>18</sup> Provide continuous non-corrosive pipe sleeve, sealed at both ends, and with minimum 50 mm (2 in.)

concrete encasement in all directions around the sleeve and metallic warning tape just above sleeve and again halfway between initial backfill and finished grade. Underground installation to be avoided, and any underground installation requires justification and variance approval.

<sup>19</sup> Provide with AWWA C105 8-mil polyethylene encasement.

<sup>20</sup> Pipe and fittings shall be provided with fusion bonded epoxy protective coating for installation in corrosive environments and exterior installations. Protective paint is acceptable for exterior above grade gas service risers with minimal exposed piping.

<sup>21</sup> Select as required based on system application, pressure, and cleanliness requirements.

<sup>22</sup> Bends and fittings not allowed for site gravity sewer piping sizes 250 mm (10 in.) and larger. Use manholes.

<sup>23</sup> Lateral bracing and thrust restraint is required for non-buried drainage piping sizes 125 mm (5 in.) and larger. Restraints for such drainage piping shall be engineered or manufactured type, sufficient for head pressure of at least 138 kPa (20 psig). Restraints methods shall be as approved by manufacturer, and shall comply with thermal movement requirements of manufacturer as applicable to the product and application. Cast iron systems shall comply with CISPI handbook. Lateral bracing is required for mechanical joints in pressure systems and all push-gasket joint applications in pressure systems, and as otherwise required by manufacturer and ANSI B31.9.

<sup>24</sup> Anti-buoyancy and other special excavation requirements (e.g., depth restrictions for plastic piping and special fill requirements) apply. Perforation pattern and quantity shall be approved by project geotech engineer in consideration of soil, bedding, structural loading, and flow requirements; and shall face down (openings are generally located at nominal 4:00 and 8:00 positions) and as described in ASTM C700 and in conformance with ASTM F-758 and AASHTO M252 Class I or as otherwise approved. Perforated piping shall be used only for portions requiring infiltration performance (headers transferring water from subsoil/foundation drains shall be solid wall non-perforated of materials as approved for underground storm drain piping). ASTM D6707 geotextile fabrics shall be provided and

be as approved by the project geotech engineer. Load limitations and backfill shall be made with consideration of the effects of the perforations to prevent pipe damage. Single wall corrugated high density polyethylene (HDPE) or other materials that do not facilitate mechanical cable cleaning or hydrojetting are unacceptable. Plastic piping shall not be used for applications deeper than 6 meters (20 ft.) below grade or with loads that would exceed manufacturers approved loading or 5% deflection (whichever is less). Double-wall corrugated polypropylene and double wall corrugated HDPE that have a smooth (non-corrugated) interior bore, elastomeric or fusion joints, and approved perforation pattern/size may be used for administrative facilities (non-clinical/non-ARF) and for other applications subject to approval and depth restrictions.

<sup>25</sup> These abbreviations and labels are to be used for pipe labeling nomenclature on-campus, unless directed otherwise in individual sections of the DRM or code. Service nomenclature may be spelled out rather than abbreviated. Alternative nomenclature for off-campus projects consistent with facility standards may be used, where providing sufficient concise service identification. Some service applications require additional nomenclatures (e.g., pressure zone, service pressure, and/or area served). Colors refer to the color of the text (first) on the color of the background (second).

<sup>26</sup> Filtered nitrogen or argon purge is required during welding. Post system welding passivation is not required for properly constructed systems however post-weld heat tint shall not exceed color 3 on AWS D18.1/AWS D18.2 scale. Systems shall be kept free of moisture or contaminants.

<sup>27</sup> Polypropylene and polyethylene polyolefin thermoplastic piping that does not contain at least 2% carbon black; as well as other non-UV resistant piping materials are only approved for use indoors and away from direct sunlight and other sources of UV light. Where such piping is installed with routine UV light exposure (including in rooms lit by fluorescent lightbulbs), shielding with an approved material (e.g., foil jacket or UV stabilized PVC or PE that is at least 20 mils thick) is required. The use of a UV-inhibiting, high-pigment content exterior grade latex paint may also be used subject to manufacturer approval. Jacketing is not required for pigmented or natural PVDF piping systems, however light traps are required for all plastic materials between

the piping and any connected UV generating equipment. The use of PVDF or alternative metal material (e.g., stainless steel) is required where constant direct ambient UV exposure cannot be avoided or reliably shielded. Polyolefin thermoplastic piping that is installed within 24 in. of the face of fluorescent lights shall be provided with protective jacketing (not paint). Only very light sanding is permitted prior to paint application; chemical prep agents shall not be used. The compatibility of any jacket containing plasticizers, integral primer, or adhesives shall be confirmed in writing with the manufacturer. No shielding is required for rooms lit only by LED lighting. Shielding is required for all above ground piping carrying compressed gas, regardless of carbon black.

<sup>28</sup> Piping of hazardous fluids, including but not limited to toxic, explosive, and any ANSI B31.3 Category M fluid is not permitted without project and application specific variance, review and approval. Where such systems are permitted, welded metal (of approved special alloy) by qualified welders is typically required and final connections that must be serviceable shall be VCR metal face seal type. Double containment may be required for some fluids. Special technical, safety, and fire protection review including risk analysis and construction approvals are required.

<sup>29</sup> With the exception of fuel gas, UHP gasses, toxic/hazardous fluids, and small molecule gasses (e.g., helium); double ferrule compression joints (e.g., Swagelok and equivalent) may be used for final exposed compressed gas and standard vacuum connections with stainless steel tubing for all sizes; provided the minimum tubing wall thickness is 0.134 in. for 1.5 in. OD tube; 0.109 in. wall for 1.25 in. OD tube; 0.83 in. wall for tubing OD smaller than 1.25 in. but larger than 0.75 in. OD; 0.065 in. wall for tubing OD 0.75 in. to 0.5 in. OD; and not less than 0.035 in. wall thickness for tubing sizes smaller than 0.5 in. OD. The use of axial swaged tubing connections with (only) stainless steel and a tubing wall thickness at least 7% of the OD, or the use of VCR type stainless steel metal gasket face seal joints with equivalent thickness stainless steel tubing is also acceptable subject to conformance with manufacturer application requirements. Double ferrule compression joints may be used with copper tubing for inert low pressure ( $\leq 276$  kPa [40 psi]) compressed gas and standard vacuum final connections only for tubing sizes 0.75 in. and smaller; and only with Type K wall thickness. Copper tubing



with ferrule joints is not acceptable for any fuel gas, hazardous fluid, UHP, small molecule gas; or for any application above 276 kPa.

<sup>30</sup> Double ferrule compression joints are acceptable for low pressure applications, below 3.4 kPa (14 in. w.g.); with 316L stainless steel tubing or A539 steel tubing only; exposed or readily accessible; and provided tubing size is 0.5 in. OD and smaller. Wall thickness shall be not less than 0.065 in. for 0.5 in. tube; and not less than 0.035 in. for tubing OD sizes <0.5 in. The use of axial swaged elastic strain preload tubing connections with (only) stainless steel and a tubing wall thickness at least 7% of the OD, or the use of VCR type stainless steel metal gasket face seal joints with equivalent thickness stainless steel tubing is also acceptable subject to conformance with manufacturer application requirements. A removable joint (e.g., union, VCR, or replaceable double ferrule compression) shall be provided for fixed lab equipment such as fumehoods. Flex connectors shall not be used for fixed lab equipment (except where necessary for seismic applications).

<sup>31</sup> May be used for pipe sizes up to 50 mm (2 in.) where working pressure ratings are at least 2,068 kPa (300 psi) and manufacturer written data permits surge pressure (or working pressure) ratings of at least 2,758 kPa (400 psi) inclusive of elastomers with operating temperature up to 66°C (150°F) .

<sup>32</sup> Thermal movement accommodation shall be provided for long pipe runs as required to prevent stress to press joints. Adequate support required, joints shall not carry system loads or be subject to torsion.

<sup>33</sup> All systems relying upon elastomeric sealing, including but not limited to press joints, grooved joints, and compression gasketed joints shall be cleaned of upstream cutting oils, fluxes, or other foreign contaminants that may not be compatible with the elastomer or otherwise damage the system or shorten useful life.

<sup>34</sup> Approved for use with water or glycol-water applications only and provided branch tube is at least (2) Pipe sizes smaller than main tube, maximum system fluid temperature is ≤66°C (150°F), both branch and main tubes are minimum Type “L” wall thickness, and main tube is size 65 mm (2.5 in.) diameter or smaller, except that 75 to 100 mm (3 to 4 in.) may be used where tubes are Type “K” wall thickness. Branch tube size shall not

exceed 50 mm (2 in.) for any application. Thermal (flexibility) and other mechanical stresses shall be relieved.

<sup>35</sup> The use of piping and fittings cleaned for oxygen service and purge gas during brazing or use of stainless material is required where vacuum systems will have in-line filtration. 0.2 micron filters can become prematurely loaded from large particles, especially as prevalent from unshielded brazing.

<sup>36</sup> See General Notes, Additional Requirements for Stainless Steel Piping Systems.

<sup>37</sup> Any of the piping, fitting, and corresponding joint methods as approved for lab waste of similar location and temperature potential may be utilized subject to fire/building code compliance. CPVC is not permitted. Polypropylene is not acceptable for potentially high temperature waste (e.g., waste from dishwashers, kettle drains, or steamers) regardless of presence of aftercoolers. PVDF may be used only for such applications with adequate flexibility analysis and compensation. High density polyethylene meeting PE-100RC may be used with fusion joints provided the wall thickness is not less PN10 (SDR 11). Exposed piping in food service areas to be copper or stainless only.

<sup>38</sup> Electrofusion joining is not permitted for high temperature waste applications (above 60°C [140°F]) or for hazardous systems or high pressure. Only socket type heat fusion or butt fusion may be used for high temperature waste with approved materials.

<sup>39</sup> Not approved for applications in plenums or where ASTM E84 fire/smoke spread compliance is required (regardless of presence of an insulation blanket).

<sup>40</sup> Special provisions may be required to address thermal flexibility to prevent damage from potentially high temperature waste. This typically includes underground piping snaking in trenches or anchor points and for above ground sufficient offsets as determined from flexibility analysis.

<sup>41</sup> Permitted only with piping that has a maximum Rockwell B scale hardness of 90, or as otherwise required by fitting manufacturer.

<sup>42</sup> The use of plastic piping in lieu of stainless steel requires technical justification and approval by NIH DTR and concurrence of the program management; and is generally not desirable in ARF. Plastic piping/

tubing is not acceptable exposed within reach of NHP's or large animals, or accessible to rabbits or other animals that may chew or otherwise damage the material unless the material is adequately protected (e.g., by metal) or reliably out of reach and protected from contact with the animals. Plastic piping/tubing is not acceptable where the material may be subject to impact from cages, racks, or other mechanical damage. Where plastics are required, the use of stress crack resistant high density polyethylene complying with PE-100RC (e.g., PE445584C) should be used for chlorinated water or hydrochloric acidification; or use PVDF (including NSF-61 pigmented grades). For applications with chlorine dioxide, stainless steel or PVDF should be used unless otherwise demonstrated suitable at constant concentrations of up to 1.5 mg/L. Systems that operate chemical free must use sanitary clean joints only (e.g., IR fusion or sanitary mechanical type, including materials as approved for high purity water systems). Research applications highly sensitive to leach out (extractables) should use stainless steel or PVDF.

<sup>43</sup> This joint type is not permitted unless systems maintain chlorine or chlorine dioxide disinfectant residual. This restriction does not apply to smooth inner bore butt fusion.

<sup>44</sup> NIH standards require the use of accessible tunnel piping distribution in lieu of direct buried piped utilities (with the exception of fuel gas, water, sanitary and storm sewer). A project-specific variance is required for use of direct buried systems. Where underground tunnels are not possible, the use of preinsulated piping systems in concrete trenches with back-water protected low point drainage and an accessible (removable concrete) cover may be required instead of direct bury for any high temperature (e.g., steam, steam condensate, heating water) application, and will need to be evaluated on a project-specific basis. Piping systems installed in concrete trenches shall meet requirements of direct bury pre-insulated systems, however the use of fiberglass jacket (in lieu of HDPE) is acceptable and drainable/dryable/testable configuration may be waived for some applications with hydrophobic insulation and approved jacket. All details of preinsulated direct bury systems shall be fully engineered, including but not limited to transitions, end seals, thermal flexibility control, man-hole terminations, and requirements for a comprehensive on-site QA/QC process to ensure proper installation of the system, joints, backfill, and pressure testing.

<sup>45</sup> Dielectric protection is required at wetted transitions between ductile iron and steel.

<sup>46</sup> Insulated systems are required at Bethesda Campus.

<sup>47</sup> The use of protective coatings designed specifically for use and to protect from corrosion under insulation (CUI) is highly recommended for ferrous cold water system piping and fittings, including stainless steel. It is recommended to specify steel piping materials factory coated as most coatings require special preparation and procedures. Examples of coatings available from piping manufacturers for these purposes include thermal sprayed aluminum (TSA), liquid applied epoxies, fusion bonded epoxy (FBE), asphaltic, urethanes, various gel coatings and tapes. For stainless steel piping aluminum foil wrapping processes should be considered. Coatings applied on-site shall be low odor, low VOC and shall be free of isocyanates or hazardous vapors if applied within occupied facilities.

<sup>48</sup> Compliance with ANSI/ASME B31.1 is required above 1,034 kPa (150 psi) (ASME B31.9 is otherwise required, except where ASME B31.3 would apply). Avoid distribution above 1,034 kPa (150 psi) unless specifically required, justified, and approved.

<sup>49</sup> Not approved for general in-building distribution system piping or for connections to compressors, aftercoolers, or potential high temperature exposure. Threaded plastic or other reduced-strength connections are not acceptable.

<sup>50</sup> Butt welding or other approved approaches that minimize crevices and provide for post-weld heat normalizing while maintaining wall thickness is preferable for steam condensate lines, especially for sizes 50 mm and larger.



## Pipe Material Designations and Material Specifications

Material-Type Designation	Pipe Material Specifications
A	Cast iron hub and spigot pipe, service weight, ASTM A74. Manufacturer to be ISO 9001 (or equivalent) and ISO 14001 or equivalent certified.
B	Cast iron hub and spigot, extra-heavy weight, ASTM A74. Manufacturer to be ISO 9001 (or equivalent) and ISO 14001 or equivalent certified.
C	Ductile iron, ASTM A-746, with 40 mil ceramic novolac epoxy interior lining. Not less than 0.25 in. piping wall thickness, except not less than Special Thickness Class 53 for applications where grooved joints are approved. Manufacturer to be ISO 9001 (or equivalent) and ISO 14001 or equivalent certified.
D	Cast iron hubless pipe, ASTM A888, CISPI 301. Manufacturer to be ISO 9001 (or equivalent) and ISO 14001 or equivalent certified.
E	NOT USED
F	Stainless steel waste pipe, Type 316/316L, ANSI A112.3.1. Manufacturer to be ISO 9001 (or equivalent) and ISO 14001 or equivalent certified.
G	Stainless steel waste pipe, Type 304, ANSI A112.3.1 Manufacturer to be ISO 9001 (or equivalent) and ISO 14001 or equivalent certified.
H	Polypropylene corrosive waste pipe, ASTM F1412, ASTM D4101, ASTM D618, ASTM D2447 Schedule 40 or 80. Virgin material with no rework. Manufacturer to be ISO 9001 (or equivalent) and ISO 14001 or equivalent certified.
I	Flame retardant polypropylene corrosive waste pipe, ASTM F1412, ASTM D4101, ASTM D618, ASTM D635, ASTM D2843, ASTM D2447, Schedule 40. Virgin material with no rework. Manufacturer to be ISO 9001 (or equivalent) and ISO 14001 or equivalent certified.
J	Borosilicate glass pipe, ASTM C1053.
K	PVC pipe, ASTM D1785 or ASTM D2665 dual stamped Schedule 40. Cellular core/foam core and co-extruded plastics are not acceptable. Manufacturer to be ISO 9001 (or equivalent) and ISO 14001 or equivalent certified.
L	PVC pipe, ASTM D1785 Schedule 80, cell classification 12454 per ASTM D1784. Manufacturer to be ISO 9001 (or equivalent) and ISO 14001 or equivalent certified.
M	Type 316L stainless steel pipe, Schedule 40, ASTM A312 seamless. Piping interior surface finish shall in no case be less than ASTM A480 grade 2D or better as required by application; not less than Grade 2B for any corrosive application. Minimum cleanliness for high cleanliness systems is ASTM G93 Level C. Type 304L may be used for clean (not USP) steam systems unless otherwise required by application Manufacturer to be ISO 9001 (or equivalent) and ISO 14001 or equivalent certified.
N	Polyvinylidene fluoride piping or tubing (or) stress crack-resistant UV inhibited high density polyethylene in compliance with PE-100RC (e.g., cell classification PE445584C) or better HDPE with a PPI TN-44 chlorine rating of not less than CC3. NSF-61, 21 CFR 177.1520 or 177.2510; and 21 CFR 178.3297 (where pigmented unless certified to NSF-61); with a minimum working pressure rating of 1,207 kPa (175 psig) at 25°C (77°F). 1,034 kPa (150 psi) working pressure is acceptable for piping if determined compatible with maximum surge pressure and design service life. 100% virgin material with no rework. Light shielding wrap or an approved permanently sealed sleeve arrangement is required for translucent material where applications do not maintain chlorine or chlorine dioxide disinfectant residual. Pipe and fittings shall match and be by same manufacturer.

Material-Type Designation	Pipe Material Specifications
O	Ductile iron pipe, ASTM A746, with AWWA/ANSI C104 cement mortar interior lining with sealcoat. Not less than 0.25 in. piping wall thickness, except not less than Special Thickness Class 53 for applications where grooved joints are approved. Manufacturer to be ISO 9001 (or equivalent) and ISO 14001 or equivalent certified.
P	Porous concrete pipe, ASTM C654, AASHTO M-176, standard or extra-strength as required. ASTM C150 Type II or Type V cement as determined compatible with soil based on testing.
Q	Seamless copper tube, ASTM B88, Type L Hard drawn; except where copper is not allowed the following additional requirements apply: Type K wall thickness is required for pipe size 100 mm (4 in.) and larger for compressed gas systems. Type K wall thickness is required for 150 mm (6 in.) and larger for pressurized liquid systems; Type K wall thickness is required for 100 mm (4 in.) and larger water piping operating at temperatures above 66°C (150°F); Type K wall thickness is required for hot and cold water piping sizes 150 mm and larger; and Type K wall thickness is recommended (but not required) for 100 mm (4 in.) hot water piping operating at temperatures below 66°C (150°F). Manufacturer to be ISO 9001 (or equivalent) and ISO 14001 or equivalent certified.
R	Seamless copper tube, ASTM B88, Type L Soft. Manufacturer to be ISO 9001 (or equivalent) and ISO 14001 or equivalent certified.
S	Seamless copper tube, ASTM B280 type ACR; not less than Type K Hard drawn for all high pressure side refrigerant applications; and listed for a working pressure of at least 4200 kPa (610 psi) at 65°C (140°F) based on the annealed condition; except that Type L wall thickness may be used for sizes 1.375 in. and smaller provided it meets this minimum working pressure requirement. The use of copper tubing is subject to use of fittings with compatible working pressure rating. Pressure ratings for all components, including hard drawn shall be based on the annealed condition only (as would be experienced from brazing). Low pressure side refrigerant applications and non-refrigerant applications may utilize Type L wall thickness; except that Type K wall thickness is required for size (4.125 in. and larger) compressed gas applications. Manufacturer to be ISO 9001 (or equivalent) and ISO 14001 or equivalent certified.
T	Seamless copper tube, ASTM B88, Type K Hard. Manufacturer to be ISO 9001 (or equivalent) and ISO 14001 or equivalent certified.
U	Seamless copper tube, ASTM B88, Type K Soft. Manufacturer to be ISO 9001 (or equivalent) and ISO 14001 or equivalent certified.
V	Ductile iron pipe, Type 2 or Type 5 NSF-61 cement lined and with NSF-61 sealcoat, ANSI/ AWWA C150, C151, AWWA C104, ANSI A21.4, minimum pressure class 350 required except that not less than Special Thickness Class 54 is required for applications where grooved joints are approved or where threads will be cut. Flanged applications shall additionally be AWWA C115, ductile iron flanges only, no cast iron or plain end flanges. Use Type 5 cement for applications with elevated sulfates. Sealcoat may be waived for locations where not required for chemical compatibility. Manufacturer to be ISO 9001 (or equivalent) and ISO 14001 or equivalent certified.

Material-Type Designation	Pipe Material Specifications
W	<p>ASME BPE compliant; ASTM A269; Type 316L stainless steel, seamless or weld-bead cold-worked to finish condition, ASME BPE SF-4 15 to 20 Ra (or better) interior finish and electropolished, Wall thickness not less than 1.65 mm (0.065 in.) for sizes up to 65 mm (2.5 in.), not less than 2.1 mm (0.083 in.) for 75–100 mm (3–4 in.) and not less than 0.277 mm (0.109 in.) for 150 mm (6 in.) and not less than 0.304 mm (0.120 in.) for 200 mm (8 in.) diameter. Chemical composition per Table I of ASTM A269 or ASME BPE. Sulfur range of 316L tube to be 0.005 to 0.012% for seamless and 0.005 to 0.017% for ERW. Post cleaning rinse water shall be 18 MΩ, 0.1 μm filters with maximum TOC=25 ppb and maximum &lt;6 CFU/100 mL. Purge gas for fabrication and drying shall be 0.005 micron or better filtered cryogenic argon or nitrogen, with less than 1 ppm moisture, oxygen, or hydrocarbons. Factory cleaned, sealed, and double bagged for UHP service. Tubing to be factory etched and include alloy and heat number or heat reference code, manufacturer, and shall be traceable back to original mill test report. Manufacturer to be ISO 9001 (or equivalent) and ISO 14001 or equivalent certified.</p>
X	<p>Ductile iron pipe, Type 2 or Type 5 double thickness NSF-61 cement lined and with NSF-61 sealcoat, ANSI/AWWA C150, C151, AWWA C104, ANSI A21.4, Special Thickness Class 53 or greater, asphalt or fusion bonded epoxy exterior coating. AWWA C105 8-mil polyethylene encasement. Use Type 5 cement for applications with elevated sulfates. Manufacturer to be ISO 9001 (or equivalent) and ISO 14001 or equivalent certified.</p>
Y	<p>Stainless steel pipe, Type 316L, Schedule 5S or Schedule 10S except that Schedule 10S is required for sizes 75 mm (3 in.) and 100 mm (4 in.), ASTM A312. ASME B36.19. AWWA C220 pipe that is ASTM A312 may be used. Piping interior surface finish shall in no case be less than ASTM A480 grade 2B smooth and reflective. Systems requiring single-manufacturer or proprietary piping/proprietary tubing are NOT permitted. Piping insulation shall be specified as chloride-free. Gaskets/elastomers shall be polymeric type, chloride and graphite-free (typically EPDM or perfluoroelastomer). Use synthetic elastomeric gaskets where possible. Manufacturer to be ISO 9001 (or equivalent) and ISO 14001 or equivalent certified.</p>
Z	<p>Brass pipe and nipples ASTM B43, ANSI B687 seamless regular or extra-strong, domestic, ASTM B456 chrome plating for finished locations. Application in water systems to be NSF-61 lead-free. Manufacturer to be ISO 9001 (or equivalent).</p>
AA	<p>Galvanized steel pipe, ASTM A53 or ASTM A106, Grade B, Type S seamless or Type E high frequency ERW electric resistance welded (HFW) and full-body normalized after upset; full body post weld ultrasonic or radiography inspection (during manufacturer); ASTM A123/ASTM A153; Schedule 40, produced by an ISO 9001 or API Q1 certified manufacturing plant. Low frequency type ERW, spiral weld, continuous weld, and laser weld material is not acceptable. Mechanical hot stretch reduced or hot reduced piping (after full-body normalizing) is preferred. Piping shall be provided with a materials test report and be mill-traceable, ERW pipe shall be fully traceable to heat number and lot number. Manufacturer to be ISO 14001 or equivalent certified.</p>
BB	<p>High density polyethylene of stress crack resistant grade and suitable for chemical waste and corrosive lab waste systems; meeting PE100RC with Cell Class PE445584C (or better), wall thickness corresponding to PN10 (SDR11) or greater, with 2% carbon black UV inhibitor; meet or exceed ASTM F1412; and in conformance with CSA B181.3. 100% virgin material with no rework. Manufacturer to be ISO 9001 (or equivalent) and ISO 14001 or equivalent certified.</p>

Material-Type Designation	Pipe Material Specifications
CC	Stainless steel sanitary tube, Type 316L: ASTM A270, ASTM A450, ANSI B36.19M, 120–150 grit sanitary and electropolished interior. ASTM A269 tubing may also be used subject to equivalent interior finish. Tubing wall thickness shall be not less than 1.65 mm (0.065 in.) for sizes 1 in. and smaller, and not less than Schedule 10 (or Schedule 10 equivalent tubing wall thickness) for sizes larger than 25 mm (1 in.) interior diameter. Wall Thickness Exception: Not less than 0.889 mm (0.035 in.) wall thickness will be permitted for exposed ADW systems that are 0.5 in. diameter or less provided chlorine levels are $\leq 4$ mg/L, chlorides are $\leq 200$ mg/L, pH is $\geq 6.5$ , and sulfate is $\leq 250$ mg/L, with no other factors that would preclude use. Manufacturer to be ISO 9001 (or equivalent) and ISO 14001 or equivalent certified.
DD	Pigmented polypropylene pipe, ASTM D4101; 21 CFR 177.1520; ASTM D638; ASTM D2122; 100% virgin material with no rework; ISO 15494. Piping wall thickness not less than SDR 11 (PN10); working pressure rating not less than 1,034 kPa (150 psig) and subject to system maximum pressure (including surge) requirements. Pressure rating shall be in conformance with ASTM D2837 hydrostatic design basis (not less than 50 year) and DIN 8077. Pipe and fittings shall match and be by same manufacturer. 100% virgin material with no rework. Manufacturer to be ISO 9001 (or equivalent) and ISO 14001 or equivalent certified.
EE	Polyvinylidene fluoride (PVDF), 21 CFR 177.1520 or 177.2510, 100% virgin material with no rework. ASTM D3222, ASTM D638, ASTM D2122, and ISO 10931 compliant; piping wall thickness not less than SDR 33 (PN10); working pressure rating not less than 1,034 kPa (150 psig) and subject to system maximum pressure (including surge) requirements; factory clean and individually bagged and sealed for high purity service. SDR 21 (PN 16) 1,586 kPa (230 psi) working pressure material may be required for high pressure systems. Pressure rating shall be in conformance with ASTM D2837 hydrostatic design basis (not less than 50-year) and DIN 8077. Extractables/static leach of assembled piping/joints shall be per SEMI standard F57- F40. PVDF materials compliant with SEMI F57 standard is acceptable and PVDF listed to NSF-61 may also be used subject to conformance with these requirements. Manufacturer to be ISO 9001 (or equivalent) and ISO 14001 or equivalent certified.
FF	PVC, polypropylene, cross-linked PEX, PVDF, high density polyethylene (PE100RC or PE4710); or 316L, stainless steel tubing as required by application and compatible with required fire/smoke criteria. Manufacturer to be ISO 9001 (or equivalent) and ISO 14001 or equivalent certified.
GG	ASTM B819 copper tube, cleaned and degreased for oxygen service by the piping manufacturer; Type L hard, factory nitrogen charged and ends capped. Any piping contaminated or not under nitrogen charge at time of installation not accepted. Type K wall thickness is required for pipe size 4 in. and larger in compressed gas systems. Manufacturer to be ISO 9001 (or equivalent) and ISO 14001 or equivalent certified.
HH	ASTM B819 copper tube, cleaned and degreased for oxygen service by the piping manufacturer; Type K hard, factory nitrogen charged and ends capped. Any piping contaminated or not under nitrogen charge at time of installation not accepted. Provide continuous sleeve and encasement for underground medical gas piping. Underground installation requires justification and variance approval. Manufacturer to be ISO 9001 (or equivalent) and ISO 14001 or equivalent certified.

Material-Type Designation	Pipe Material Specifications
II	Carbon steel pipe, ASTM A53 or A106, Grade B, Type S seamless; or Type E high frequency ERW electric resistance welded (HFW) and full-body normalized after upset; full body post weld ultrasonic or radiography inspection (during manufacturer); Schedule 40, produced by an ISO 9001 or API Q1 certified manufacturing plant. Low frequency type ERW, spiral weld, continuous weld, and laser weld material is not acceptable. Mechanical hot stretch reduced or hot reduced piping (after full-body normalizing) is preferred. Piping shall be provided with a materials test report and be mill-traceable, ERW pipe shall be fully traceable to heat number and lot number. Manufacturer to be ISO 14001 or equivalent certified. Schedule 80 may be used where justified by application, but is not generally required.
JJ	Carbon steel pipe, ASTM A53 or A106; Grade B, Type S seamless Schedule 80, or Schedule 160, produced by an ISO 9001 or API Q1 certified manufacturing plant. Piping shall be provided with a materials test report and be fully traceable to heat number and lot number. Manufacturer to be ISO 14001 or equivalent certified.
KK	Carbon steel pipe, ASTM A106, ASME SA106, Grade B, Type S seamless, Schedule 40; produced by an ISO 9001 or API Q1 certified manufacturing plant. Piping shall be provided with a materials test report and be fully traceable to heat number and lot number. Manufacturer to be ISO 14001 or equivalent certified.
LL	Carbon steel pipe, ASTM A106, ASME SA106, Grade B, Type S seamless, Schedule 80 or Schedule 160, produced by an ISO 9001 or API Q1 certified manufacturing plant. Steel shall be mill-traceable. Piping shall be provided with a materials test report and shall be fully traceable to heat number and lot number. Manufacturer to be ISO 14001 or equivalent certified.
MM	Carbon steel pipe, API-5L Seamless or DSAW linear weld; Grade B (or “X” grades); PSL-2; not less than 12.7 mm (0.5 in.) wall thickness, produced by an ISO 9001 or API Q1 certified manufacturing plant and fully traceable per API 5L SR15.1 and SR15.2. Low frequency welded, spiral weld, continuous weld, and laser weld material is not acceptable. Provide post-weld stress relief (e.g., post weld heat treatment at least the weld seam and heat affected zone; ideally full-body normalized) product where welded (instead of seamless) pipe is used. Manufacturer to be ISO 14001 or equivalent certified.

Material-Type Designation	Pipe Material Specifications
NN	<p>High density polyethylene fuel gas pipe and tubing, stress crack resistant PE4710-PE100; cell classification of PE445574C or PE445576C (or better cell class), with bimodal resin. Thickness corresponding to SDR-11 or thicker as required, ASTM F2897; ASTM D2513; ASTM D3350, minimum hydrostatic design basis of 11,031 kPa (1,600 psi) at 22.8°C (73°F) and 6,894 kPa at 60°C (1,000 psi at 140°F) per ASTM D2837; 100% virgin material with no rework. Comply with stress crack, slow crack growth, rapid crack propagation and test provisions of ISO 13477 (S4), ISO 9080, and Part 192 of Title 49 CFR and meet PE-100RC. Piping to be black with multiple yellow stripes provided with carbon black UV stabilization for unprotected open storage for at least 10 years; and compatible for both natural gas and LPG (propane) application. Copper tube size (CTS) is not acceptable. Manufacturer to be ISO 9001 (or equivalent) and ISO 14001 or equivalent certified. ASTM F2830 compliant with these requirements is acceptable. Compliance with Pipeline and Hazardous Materials Safety Administration (PHMSA) requirements and advisories (including but not limited to shelf life) is mandatory. Materials with gouges or scratches deeper than 5% wall thickness or as otherwise prohibited shall not be used.</p> <p>Medium density polyethylene (MDPE, PE2708) with a cell classification of PE234373E (or better cell class); with a 8,618 kPa (1,250 psi) hydrostatic design basis at 22.8°C (73°F), and 6,894 kPa at 60°C (1,000 psi at 140°F) per ASTM D2837; bimodal resin only and otherwise compliant with the above, may be used for open-trench natural gas (not LPG) applications of sizes 75 mm (3 in.) and smaller (only), provided the material serves only single buildings; and provided natural gas maximum pressures do not exceed 413 kPa (60 psig). Piping shall be yellow in color and suitable for unprotected storage for at least 4 years.</p>
OO	<p>Steel fuel gas tubing, ASTM A539 electric resistance welded. Manufacturer to be ISO 9001 (or equivalent) and ISO 14001 or equivalent certified. Tubing wall thickness shall be not less than 0.65 in. for tubing sizes 0.75 in. to 0.5 in. outside diameter; and not less than 0.035 in. wall thickness for tubing smaller than 0.5 in. OD.</p>
PP	<p>Schedule 40 PVDF, ASTM F1673, ASTM D3222. Manufacturer to be ISO 9001 (or equivalent) and ISO 14001 or equivalent certified.</p>
QQ	<p>Perforated PVC ASTM D2665 or ASTM D1785 only. SDR 35 is not acceptable. Perforations shall be per ASTM C700 or ASTM F-758 and AASHTO M252 unless otherwise required by geotech or structural engineer. Piping manufacturer to be ISO 9001 (or equivalent) and ISO 14001 or equivalent certified.</p>
RR	<p>Sizes 40 mm (1.5 in.) and smaller: Type 316L fully annealed stainless steel tubing; ASTM A213 or ASTM A269 with hardness not to exceed Rockwell HRb 80 or as otherwise required by fitting manufacturer; or ASTM A312 Type 316L pipe of fitting manufacturer-approved hardness. Exterior surface shall be smooth and of surface quality in conformance with fitting manufacturers standard requirements. Interior surface finish, cleanliness and pipe wall selected for application; 25µ in Ra average (32µ in. Ra max.) or better for all clean, lab, and medical gasses (mil standard Grade 2D or better for non-corrosive vacuum). Minimum cleanliness for pressurized systems is ASTM G93 Level C. Tube/pipe wall thickness to outside diameter ratio shall in no case be less than 0.07. Factory passivated. Packaging, joint precautions, cleaning, and purging as appropriate to required service purity. Manufacturer to be ISO 9001 (or equivalent) certified.</p> <p>Sizes 50 mm and larger: As above, but ASTM A312 pipe only, with a wall thickness of Schedule 40S or Schedule 10S; except that ASTM A269 tubing as above may be used with wall thickness not less than Schedule 10S and within required system working pressure ratings.</p>



Material-Type Designation	Pipe Material Specifications
SS	Vitrified Clay Pipe, Perforated, ASTM C700, standard or extra-strength as required. Manufacturer to be ISO 9001 (or equivalent) and ISO 14001 or equivalent certified.
TT	Stainless steel pipe, Type 316L, ASTM A312, ASTM A240, ANSI/ASME B36.19. Schedule 10S is acceptable for sizes up to 100 mm (4 in.). Schedule 40S is required for sizes 150 mm (6 in.) and larger. AWWA C220 pipe that is ASTM A312 may be used. Piping interior surface finish shall in no case be less than ASTM A480 grade 2B smooth and reflective. Piping insulation shall be specified as chloride-free. Gaskets/elastomers shall be polymeric type, chloride and graphite-free (typically EPDM or perofluoroelastomer). Use synthetic elastomeric gaskets where possible. Manufacturer to be ISO 9001 (or equivalent) and ISO 14001 or equivalent certified.
UU	Pigmented polypropylene pipe, factory clean and oil-free for high purity service and individually bagged and sealed; ASTM D4101; 21 CFR 177.1520; ASTM D638; ASTM D2122; 100% virgin material with no rework; ISO 15494. Piping wall thickness not less than SDR 11 (PN10); working pressure rating not less than 1,034 kPa (150 psig) and subject to system maximum pressure (including surge) requirements, Pressure rating shall be in conformance with ASTM D2837 hydrostatic design basis (not less than 50 year) and DIN 8077. Only reputable manufacturers of high purity piping system products shall be specified and selected piping product shall not leach pigment or other contaminants into water system to such levels as to compromise required water quality. Natural (unpigmented) material is not permitted unless fitted with an approved jacket. Extractables/static leach values for TOC of assembled piping and joints shall not exceed 50,000 µg/m <sup>2</sup> based on high temperature (85°C) testing per SEMI standard F57-F40 (and should typically be below 40,000 µg/m <sup>2</sup> ). Pipe and fittings shall match and be by same manufacturer. Manufacturer to be ISO 9001 (or equivalent) and ISO 14001 or equivalent certified.
V-V	Perfluoroalkoxy (PFA) tubing, ultrapure type factory clean and packaged; ASTM D3307; not less than 0.062 in. wall thickness; ASTM D2837 and not less than 1,034 kPa (150 psig); virgin resin, 21 CFR 177.1550 or SEMI F57-0301. The use of PFA flare-thru hose design is also acceptable. Where suitable PFA tubing is not readily available and subject to avoidance of deadleg; the use of PVDF tubing may be accepted. Tubing shall be smooth inner bore, non-corrugated. Tubing length and connections quantity shall be absolutely minimized. Manufacturer to be ISO 9001 (or equivalent) and ISO 14001 or equivalent certified.
WW	Carbon steel pipe, ASTM A53 or A106, Grade B, Type S seamless; or Type E high frequency ERW electric resistance welded (HFW) and full-body normalized after upset; full body post weld ultrasonic or radiography inspection (during manufacturer); Schedule 80, XS, or extra heavy wall; produced by an ISO 9001 or API Q1 certified manufacturing plant. Low frequency type ERW, spiral weld, continuous weld, and laser weld material is not acceptable. Mechanical hot stretch reduced or hot reduced piping (after full-body normalizing) is preferred. Piping shall be provided with a materials test report and be mill-traceable, ERW pipe shall be fully traceable to heat number and lot number. Manufacturer to be ISO 14001 or equivalent certified. Schedule 80 may be used where justified by application, but is not generally required.

Material-Type Designation	Pipe Material Specifications
XX	<p>Flanged ductile iron pipe with factory-applied, 40 mils coal-tar free abrasion-resistant ceramapure epoxy interior lining; ANSI/AWWA C110/A21.10, or C153, AWWA C210; AWWA C115; not less than Special Thickness Class 53. Ductile iron flanges only (no cast iron flanges). If piping is installed outdoors, the exterior of fittings shall be provided with factory primed finish and painted white epoxy or polysiloxane or otherwise protected from substantial temperature variations between piping interior and exterior. Standard asphaltic or FBE exterior coating for indoor applications. Piping shall be manufacturer prepared prior to lining/coating in accordance with lining manufacturer recommendations by certified applicators and holiday tested. Manufacturer to be ISO 9001 (or equivalent) and ISO 14001 or equivalent certified.</p>
YY	<p>Hoses shall be ISO 10380 compliant corrugated stainless steel, annular closed pitch Type 316L hose with 304, 316, or 321 braid, heavy wall carrier tubing; with single layer stainless steel braid. Full penetration welds are required for the entire hose assembly, including at the hose to fitting connection; (or) ISO 10380 compliant corrugated bronze, annular closed pitch, with single layer bronze braid; (or) equivalent compatible hydrogenated nitrile (HNBR) or fluoropolymer hose (smooth bore or corrugated) with stainless steel braid and full radial factory applied hydraulic crimp hose to end fitting connection. In addition, all hoses shall be compatible with water, glycols, standard corrosion inhibitors and oils, including but not limited to mineral oil, paraffinic oil, general petroleum distillates, and trace ammonium and zinc chlorides; and resistant to UV and age deterioration. Working pressure rating of the braided hose shall be at least 5,515 kPa (800 psi); burst pressure not less than 5515 kPa (3,200 psi) based on the completed hose assembly (after any welding, brazing, or other processes during manufacture or installation that reduces pressure rating. Hoses for hot water systems shall meet required pressure rating at not less than 82°C (180°F). The use of non-braided hoses is unacceptable, however the hose shall be of sufficient thickness to provide a manufacturer recommended working pressure rating unrestrained and without braid of at least 552 kPa (80 psi). Hose shall be single layer metal braided, fully welded, with no elastomeric seals. The use of double braiding or extra-heavy braiding gauge to achieve required pressure rating (rather than increased carrier wall thickness with single standard braid) is unacceptable.</p> <p>End connections shall be permanent factory attached, SAE Flare type (e.g., JIC flare), flare-swivel, or hex NPT connection; except that bronze/copper hoses may be solder end. Hose live length shall not exceed 762 mm (30 in.). Hoses shall be installed with strict conformance with manufacturer bend radii requirements. Manufacturer to be ISO 9001 (or equivalent) certified.</p>
ZZ	<p>Carbon steel pipe, A106, Grade B, Type S seamless; or Type E high frequency ERW electric resistance welded (ERW) and full-body normalized after upset; full body post weld ultrasonic or radiography inspection (during manufacturer); Schedule 40, produced by an ISO 9001 or API Q1 certified manufacturing plant. Low frequency type ERW, spiral weld, continuous weld, and laser weld material is not acceptable. Mechanical hot stretch reduced or hot reduced piping (after full-body normalizing) is preferred. Piping shall be provided with a materials test report and be mill-traceable, ERW pipe shall be fully traceable to heat number and lot number. Manufacturer to be ISO 14001 or equivalent certified. Schedule 80 may be used where justified by application, but is not generally required.</p>

Material-Type Designation	Pipe Material Specifications
AAA	<p>Type 316L stainless steel, ASTM A269, ASTM A632 (for sizes over 15 mm (0.5 in.); seamless for sizes 25 mm (1 in.) OD and less; annealed; SEMATECH 91060573B; SEMATECH 90120403B, SEMATECH 90120401B; double melt VIM/VAR or AOD/VAR, 60 to 90 Rb, seamless or weld-bead cold-worked to finish condition, 7µ in. Ra average, 10 µ in. Ra max (or better) interior finish; electropolished and passivated with orbital weld square ends, tube wall thickness to outside diameter ratio shall in no case be less than 0.07. Sulfur range of 316L tube to be 0.005 to 0.012% for seamless and 0.005 to 0.017% for ERW. Post cleaning rinse water shall be 18 MΩ, 0.1 µm filters with maximum TOC=25 ppb and maximum &lt;6 CFU/100 mL; moisture &lt;0.5 ppm Particles shall not exceed 10 particles &gt; 0.01 µm per cubic foot or any particles over 0.3 micron. Purge gas for fabrication and drying shall be 0.005 micron or better filtered cryogenic argon or nitrogen, with less than 1 ppm moisture, oxygen, or hydrocarbons. Factory cleaned, sealed, and double bagged for UHP service in ISO Class 4 or better cleanroom. Tubing to be factory etched and include alloy and heat number or heat reference code as well as manufacturer and shall be traceable back to original mill test report. Include moisture, particulate and tube chemical analysis and chromium ratios from XPS analysis. Manufacturer to be ISO 9001 (or equivalent) and ISO 14001 or equivalent certified.</p>
BBB	<p>Vacuum jacketed, passive (static) type system by a reputable cryogenic vacuum jacketed piping systems manufacturer, selected as specific to each fluid application; with an engineered chemical gettering system (palladium oxide only) for the vacuum annulus including sufficient molecular sieve and hydrogen converter to maintain uncontaminated vacuum. All systems shall be clean for O<sub>2</sub> service, except that carbon dioxide need only be clean for cryogenic service. Type 304L stainless steel of at least Schedule 5 wall thickness with internal bellows shall be used for the inner pipe, with Type 304 stainless for the vacuum jacket. ASME Section IX certified welders, post-weld X-ray for at least 5% of factory welds and 100% of field welds, ASME B31.3 compliance required, and vacuum jacket shall be designed in accordance with ASME BPVC Section VIII, interior vacuum, exterior atmospheric at ambient temperature. 100% sensitive leak testing required for piping and vacuum annulus (helium 1 x 10<sup>-9</sup> cc/s). Systems 50 mm (2 in.) and smaller shall utilize field bayonet-type clamp-secured connections. Systems larger than 50 mm, or at pressure above 1,034 kPa (150 psi) shall utilize manufactured-approved ASME B31.3 butt weld with vacuum sealed joints only, and post weld pneumatic (at least 758 kPa) and sensitive leak test (helium 1 x 10<sup>-9</sup> cc/s. External bellows or Invar 36 carrier tube construction required for applications requiring &gt;1,034 kPa (not typically required). Bayonets shall utilize dissimilar metal sealing with an Invar 36 male bayonet. Nose-seal (PTFE tube) bayonets are unacceptable. No system may be less than 1,034 kPa (150 psi) working pressure. Engineered flexibility analysis required.</p>
CCC	<p>Reinforced concrete pipe, ASTM C76, Class IV or Class V as required, AASHTO M170; ASTM C150 Type II or Type V cement as required; with lifting anchors (not holes), ASTM C443 neoprene or isoprene o-ring compression gaskets. ASTM C361 as required.</p>
DDD	<p>AWWA C900 PVC with polyethylene encased cement lined ductile iron fittings, restrained joints designed for use with C900 PVC as required. Ductile fittings used for sanitary sewer service shall include ceramic epoxy lining.</p>
EEE	<p>Vitrified clay pipe (VCP) with gasketed joints, extra strength if greater than (12 ft.) deep. Where trenchless piping installations are provided, utilize VCP jacking piping.</p>

Material-Type Designation	Pipe Material Specifications
FFF	<p>Ductile iron pipe with factory-applied, 40 mils coal-tar free abrasion-resistant ceramapure epoxy interior lining; Ceramapure also applied to bells and pipe ends (including field cut); ANSI/AWWA C150, C151, AWWA C210; asphalt or fusion bonded epoxy exterior coating. AWWA C105 8-mil polyethylene encasement. Piping shall be manufacturer prepared prior to lining/coating in accordance with lining manufacturer recommendations by certified applicators and holiday tested. Manufacturer to be ISO 9001 (or equivalent) and ISO 14001 or equivalent certified.</p>
GGG	<p>ANSI B31.1 compliant preinsulated piping system for high temperature fluids utilizing an approved carrier pipe and fittings and a fully drainable, dryable, and air testable (to 35 kPa) jacket system that does not require cathodic protection. The system shall be suitable for direct burial with high groundwater applications, shall be installed in dry conditions, and shall consist of non-woven glass fiber reinforced hydrophobic silica aerogel insulation of approved thickness with stainless steel banding and centered with an annular support (spider) structure, an internal epoxy coated and holiday tested continuous welded steel conduit over the carrier pipe insulation/support system; a bonded and at least 90% closed cell foam, air-pocket free insulation, a polyethylene coated aluminum diffusion barrier, and exterior high density polyethylene thermal fused jacket of not less than 6.4 mm (0.25 in.) thick that is joined by electrofusion or butt fusion thermal welding with post-installation air pressure-tested joints. The exterior jacket shall be of anti-oxidant encompassed environmental stress crack resistant virgin HDPE, with an ASTM D3350 cell classification; and made from PE4710 (preferred) or other PE100 resin with carbon black, a hydrostatic design basis of <math>\geq 8620</math> kPa (1,250 psi) per ASTM D2837; and ASTM F1473 PENT test value of <math>\geq 500</math> hours. Soils compatibility and water table testing is required along the piping route and backfill shall be in accordance with Plastic Pipe Institute (PPI) and manufacturer guidelines. Fittings, directional changes, and branches shall be equivalent to the rest of the preinsulated piping. All ends seals, gland seals, expansion loops, and anchors shall be engineered and factory fabricated for full drainage and to prevent ingress of moisture and systems shall terminate inside the building. Avoid expansion joints. Visual inspection to confirm complete insulation coverage and void-free foam application prior to covering; or use infrared or radiography. Systems shall be produced by a reputable preinsulated piping system manufacturer, Special attention is required to end seal terminations at manholes, valve pits etc. Devices prone to seal relaxation, disbondment, elastomer degradation or corrosion-induced component seal failure should be avoided. Manufacturer ISO 9001 and ISO 14001 certified (or equivalent).</p> <p>Systems for steam and steam condensate shall include a replaceable, dryable, and reusable continuous leak detection system with pull ports and leak location capability. End joints shall be fully sealed; connected manholes for steam traps shall include automatic monitored municipal grade sump pumps and high water alarms to BAS to ensure maintenance of dry conditions. Fluid (carrier) pipe materials shall be as follows:</p> <p>Steam: Not less than Schedule 80 wall thickness seamless steel in full conformance with Pipe Type “LL”; fitting type “XXIX”; and ANSI B31.1 butt fusion joint type ‘r’.</p> <p>Steam Condensate: Not less than Schedule 160 wall thickness seamless steel in full conformance with Pipe Type “LL”; fitting type “XXIX”; and ANSI B31.1 butt fusion joint type ‘r’. A separate, dedicated conduit is required for steam piping. Shared/multi-pipe systems are not acceptable. Installation of a spare/second, independent blanked-off steam condensate full size (for future pipe failure mitigation) shall be considered and determined if required on a project specific basis.</p> <p>Heating Water: Not less than Schedule 80 wall thickness seamless steel in full conformance with Pipe Type “JJ”; fitting type “XXIX”; and ANSI B31.1 butt fusion joint type ‘r’.</p>

Material-Type Designation	Pipe Material Specifications
HHH	<p>ANSI B31.1 compliant preinsulated piping system for cold liquid fluids utilizing an approved carrier pipe and fittings, a bonded and at least 90% closed cell foam insulation system constructed to be air-pocket free, and an exterior high density polyethylene thermal fused jacket of not less than 5 mm (0.2 in.) thick that is joined by electrofusion thermal welding with post-installation air pressure-tested joints. The exterior jacket shall be of anti-oxidant encompassed environmental stress crack resistant virgin HDPE with an ASTM D3350 cell classification, and made from PE4710 (preferred) or other PE100 resin with carbon black, a hydrostatic design basis of <math>\geq 8,620</math> kPa (1,250 psi) per ASTM D2837; and ASTM F1473 PENT test value of <math>\geq 500</math> hours. Soils compatibility and water table testing is required along the piping route and backfill shall be in accordance with Plastic Pipe Institute (PPI) and manufacturer guidelines. Fittings, directional changes, and branches shall be equivalent to the rest of the preinsulated piping. All ends seals, gland seals, and components shall be engineered and factory fabricated to prevent ingress of moisture and systems shall terminate inside the building. Install in dry conditions. Visual inspection to confirm complete insulation coverage and void-free foam application prior to covering; or use infrared or radiography. Engineered flexibility analysis shall be submitted and reviewed. Systems shall be produced by a reputable preinsulated piping system manufacturer, Manufacturer ISO 9001 and ISO 14001 certified (or equivalent).</p> <p>Chilled Water: Not less than Schedule 80 Wall thickness seamless steel in full conformance with Pipe Type “LL”; fitting type “XXIX”; and ANSI B31.1 butt fusion joint type ‘r’; (or) Ductile Iron in full conformance with Pipe Type “X”, Fitting Type “XXI”, Joint type “t”; (or) Ductile Iron with Pipe Type “FFF”, Fitting Type “XLVIII”, and joint type “t”.</p>
III	<p>SDR 26 (PS 115) or AWWA C900 or AWWA C905, or PVC, virgin material; with gasket joints. SDR-35 is not acceptable. Plastic pipe is not acceptable for pipelines greater than 15 ft. deep, or less than 4 ft. deep.</p>
JJJ	<p>SDR 26 (PS 115) or AWWA C900 PVC; virgin material; with gasket joints. SDR 35 is not acceptable. ASTM D1785 Schedule 40 solid wall PVC (no cellular core or coextruded material) with 2-part solvent weld joints may also be used. Plastic pipe is not acceptable for pipelines greater than 15 ft. deep, or less than 4 ft. deep.</p>

Material-Type Designation	Pipe Material Specifications
KKK	<p>High density polyethylene piping specifically engineered and manufacturer approved for compressed air applications at working pressures of at least 1,103 kPa (160 psi) for a usable service life of not less than 50 years; compatible with standard compressed air system hydrocarbons (including conventional lubricants as could be present from oil-sealed compressors regardless if system is oil-free); rapid crack propagation and stress crack resistant; bimodal resin; PE4710 material; cell classification PE445584C or PE 445576C; (except that carbon black may be waived for underground installation where piping includes sufficient oxidation inhibitor and sufficient pigment for a resin-manufacturer approved outdoor UV exposure of at least 2 years, and also for above ground indoor installation with approved protective jacket, provided the product is cell class code “E”); ISO 13479 PENT &gt;10,000 hours. Rapid crack propagation tested and determined compatible for compressed air application as per ISO 13477 S4; wall thickness for pipe and fittings shall correspond to not thinner than DR 9; ASTM D3350 minimum hydrostatic design basis of 11,031 kPa (1,600 psi) at 22.8°C (73°F) and 6,894 kPa at 60°C (1,000 psi at 140°F) per ASTM D2837; 100% virgin material with no rework. Listed per PPI TR-4 as a PE 100 with a MRS (Minimum Required Strength) of 1,000 kPpa (1450 psi) at 20°C (68°F). Comply with stress crack, slow crack growth, rapid crack propagation and test provisions of ISO 13477, ISO 9080, and Part 192 of Title 49 CFR and meet PE-100RC. Copper tube size material is not acceptable. Fittings shall be ASTM D3261 or F2620 butt fusion type except ASTM D2683 socket fusion may be used for 50 mm (2 in.) and smaller. Socket fusion is acceptable for size 100 mm (4 in.) and smaller with DR 7 rated systems provided pipe sizes above 50 mm are inspected and approved by a certified weld inspector per AWS G1.6. Comply with ASTM F2897 and F3124. Pipe and fittings shall be compatible. Manufacturer to be ISO 9001 (or equivalent) and ISO 14001 or equivalent certified. Fusion shall be in conformance with PPI methods and manufacturer recommendations and welders shall be qualified per AWS B2.4 Product which has been exposed to UV (open packages or piping stored outdoors) or which has gouges or scratches deeper than 5% wall thickness (or as otherwise prohibited) shall not be used.</p>
LLL	<p>High density polyethylene, PE4710 with a cell classification of PE445574C (or better); ASTM F714, ASTM D3350; wall thickness corresponding to not thinner than DR 17 (except not thinner than DR 11 for any force main application); 11,031 kPa (1,600 psi) at 22.8°C (73°F) and 6,894 kPa at 60°C (1,000 psi at 140°F) per ASTM D2837; 100% virgin material with no rework; ASTM D3261 fittings, black pipe with green stripe. Butt heat fusion joints joined per manufacturer requirements and PPI recommended procedure. Smooth bore, solid wall. No piping with abrasion, cuts, or gouges beyond 5% of depth may be installed. Mechanical transition joint with Type 316 stainless steel stiffener. Plastic pipe is not acceptable for pipelines greater than 15 ft. deep or less than 4 ft. deep.</p>



## Fitting Type and Fitting Specifications

Fitting Type Designation	Pipe Fitting Specifications
I	Service cast iron hub and spigot, ASTM A74. Manufacturer to be ISO 9001 (or equivalent) and ISO 14001 or equivalent certified.
II	Extra-heavy cast iron hub and spigot, ASTM A74. Manufacturer to be ISO 9001 (or equivalent) and ISO 14001 or equivalent certified.
III	Ductile iron, ANSI/AWWA C110, ASTM A746, with AWWA C116 fusion bonded epoxy or 40 mil ceramic novolac epoxy, interior lining and fitting patterns consistent with drainage systems. Manufacturer to be ISO 9001 (or equivalent) and ISO 14001 or equivalent certified.
IV	Cast-iron hubless fittings, CISPI 301. Manufacturer to be ISO 9001 (or equivalent) and ISO 14001 or equivalent certified.
V	NOT USED
VI	Type 316/316L stainless steel, drainage pattern, ANSI A112.3.1. Manufacturer to be ISO 9001 (or equivalent) and ISO 14001 or equivalent certified.
VII	Type 304 stainless steel, drainage pattern, ANSI A112.3.1. Manufacturer to be ISO 9001 (or equivalent) and ISO 14001 or equivalent certified.
VIII	Wrought copper and bronze drainage pattern fittings, ANSI B16.23 or ANSI B16.29. Manufacturer to be ISO 9001 (or equivalent) and ISO 14001 or equivalent certified.
IX	Cast-iron, 'Durham' drainage pattern, ANSI B16.12, ASTM A126, ASTM A153. Manufacturer to be ISO 9001 (or equivalent) and ISO 14001 or equivalent certified.
X	Polypropylene drainage pattern, ASTM F1412, ASTM D4101, ASTM D618, ASTM D2447, ASTM D3311; virgin material with no rework. Manufacturer to be ISO 9001 (or equivalent) and ISO 14001 or equivalent certified.
XI	Borosilicate glass drainage pattern, ASTM C1053.
XII	Flame-retardant polypropylene drainage pattern, ASTM F1412, ASTM D4101, ASTM D618, ASTM D2843, ASTM D635, ASTM D2447, and ASTM D3311; virgin material with no rework. Manufacturer to be ISO 9001 (or equivalent) and ISO 14001 or equivalent certified.
XIII	Chemically resistant compatible with system pipe material and application, with pressure rating equivalent to at least that of the piping. Manufacturer to be ISO 9001 (or equivalent) and ISO 14001 or equivalent certified.
XIV	Polyvinyl chloride, drainage pattern, ASTM D2665, ASTM D3311. Manufacturer to be ISO 9001 (or equivalent) and ISO 14001 or equivalent certified.
XV	Type 316L (or CF3M) stainless steel of wall thickness not less than piping system and required working pressure. ASTM A403 Grade WP Class S or W for pipe systems; ASTM A269 or ASTM A270, ASTM A450, ASTM A479, ANSI B36.19M or ASME BPE weld fitting for tubing. Fittings factory faced for butt weld connections. Interior surface finish, cleanliness and pipe wall selected for application; 25 $\mu$ in Ra average (32 $\mu$ in. Ra max.) or better for all clean, lab, and medical gasses (mill standard Grade 2D, or better for non-corrosive vacuum and clean (but not USP) steam, not less than Grade 2B for any corrosive application. Minimum cleanliness for high cleanliness systems is ASTM G93 Level C. Wall thickness to outside diameter ratio shall in no case be less than 0.07. Factory passivated. Packaging, joint precautions, cleaning, and purging as appropriate to required service. Manufacturer to be ISO 9001 (or equivalent) and ISO 14001 or equivalent certified.

Fitting Type Designation	Pipe Fitting Specifications
XVI	Ductile iron, ANSI/AWWA C110, ASTM A746, with ANSI/AWW C104 cement mortar lining and sealcoat, fitting pattern consistent with drainage systems. Manufacturer to be ISO 9001 (or equivalent) and ISO 14001 or equivalent certified.
XVII	Porous concrete drainage fittings, ASTM C654, AASHTO M176.
XVIII	Wrought copper solder cup type fittings, ANSI/ASME B16.22 or B16.18. Manufacturer to be ISO 9001 (or equivalent) and ISO 14001 or equivalent certified.
XIX	Ductile iron Type 2 or Type 5 NSF-61 cement lined and with NSF-61 sealcoat, ANSI/AWWA C110/A21.10, or C153, AWWA C104/ANSI A21.4, Minimum Pressure Class 350. Flanged applications shall additionally be AWWA C115 and with ductile iron flanges only (no cast iron flanges). Sealcoat may be waived for locations where not required for chemical compatibility. Use Type 5 cement for applications with elevated sulfates. NSF-61 Fusion bonded epoxy interior also acceptable. Manufacturer to be ISO 9001 (or equivalent) and ISO 14001 or equivalent certified.
XX	Butt-weld Type 316L (or CF3M); ASTM A403 Class WP or AWWA C226 (that is also ASTM A403), and ASTM A182 (for forged fittings), Schedule 10, except that Schedule 40 is required for sizes 150 mm (6 in.) and larger. Fittings which have been welded (including during manufacture) shall be manufacturer descaled and passivated. Fitting interior surface finish shall in no case be less than ASTM A480 grade 2B smooth and reflective. Manufacturer to be ISO 9001 (or equivalent) and ISO 14001 or equivalent certified.
XXI	Ductile iron Type 2 or Type 5 double thickness NSF-61 cement lined and with NSF-61 sealcoat ANSI/AWWA C110/A21.10,; AWWA C104/ANSI A21.4 Minimum Pressure Class 350, all materials NSF-61 compliant, AWWA C105 8-mil polyethylene encasement. Use Type 5 cement for applications with elevated sulfates. NSF-61 Fusion bonded epoxy interior also acceptable. Manufacturer to be ISO 9001 (or equivalent) and ISO 14001 or equivalent certified.
XXII	Stainless steel mechanical groove, Type 316L, Schedule 10 is minimum acceptable for sizes up to 100 mm, Schedule 40 for sizes 150 mm (6 in.) and larger, ASTM A312, ASTM A403 WP or CR grade, or ASTM A774; or ASTM A778, ASTM A743, ASTM A744, subject to NSF-61 conformance. Plain-end fittings are not acceptable. Fittings shall be selected for 2758 kPa (400 psig) or greater pressure rating. ASTM A774/ASTM A778 fittings which have been welded (including during manufacture) shall be manufacturer descaled and passivated. Fitting interior surface finish shall in no case be less than ASTM A480 grade 2B smooth and reflective. Manufacturer to be ISO 9001 (or equivalent) and ISO 14001 or equivalent certified.
XXIII	Extra heavy domestic cast or forged, bronze; corrosion (including dezincification) resistant alloy; threaded pressure fittings; ANSI B16.15; ASTM B584; ANSI B20.1; AWWA C800. Provide with ASTM B456 chrome plating for finished locations. NSF-61 lead-free compliance required for water systems. Manufacturer identification shall be permanently factory-marked on fittings. Lead-free plating (in lieu of lead-free construction) is unacceptable. Fittings additionally compatible with ANSI B16.26 (flare type instead of NPT) may be used for accessible applications with Type K copper tubing (only) where identified as a satisfactory joint type. Manufacturer to be ISO 9001 (or equivalent) and ISO 14001 or equivalent certified.

Fitting Type Designation	Pipe Fitting Specifications
XXIV	<p>Polyvinylidene fluoride (PVDF) or pigmented stress crack resistant UV inhibited high density polyethylene in compliance with PE-100RC (e.g., cell classification PE445584C) or better HDPE with a PPI TN-44 chlorine rating of not less than CC3. 1034 kPa (150 psi) minimum working pressure rating; NSF-61 or 21 CFR 177.1520 or 177.2510 certified, 21 CFR 178.3297 (for pigmented products unless NSF-61); designed for either IR fusion, butt fusion, socket fusion, or sanitary style mechanical joint to match approved joint application as indicated. Pipe and fittings shall be same manufacturer. 100% virgin material with no rework. Manufacturer to be ISO 9001 (or equivalent) and ISO 14001 or equivalent certified.</p>
XXV	<p>Stainless steel sanitary fitting, Type 316L (or CF3M), not less than Schedule 5 equivalent wall thickness, sanitary 120–150 grit and electropolished interior finish, sanitary joint/clean joint design connections without pockets or crevices, ASTM A270, ASTM A450, ANSI B36.19M. ASTM A269 may also be used with equivalent interior finish. Manufacturer to be ISO 9001 (or equivalent) and ISO 14001 or equivalent certified.</p>
XXVI	<p>Pigmented polypropylene, infrared-butt fusion style, factory clean and oil-free for high purity service and individually bagged and sealed. ASTM D4101; 21 CFR 177.1520; ASTM D638; ASTM D2122; 100% virgin material with no rework; ISO 15494. Wall thickness not less than SDR 11 (PN10); working pressure rating not less than 1,034 kPa (150 psig) and subject to system maximum pressure (including surge) requirements. Pressure rating shall be in conformance with ASTM D2837 hydrostatic design basis (not less than 50-year) and DIN 8077. Extractables/static leach values for TOC of assembled piping and joints shall not exceed 50,000 µg/m<sup>2</sup> based on high temperature (85°C) testing per SEMI standard F57–F40 (and should typically be below 40,000 µg/m<sup>2</sup>). Only reputable manufacturers of high purity piping system products shall be specified and selected materials shall not leach pigment or other contaminants into water system to such levels as to compromise required water quality. Pipe and fittings shall match and be by same manufacturer. Manufacturer to be ISO 9001 (or equivalent) and ISO 14001 or equivalent certified.</p>
XXVII	<p>Wrought copper solder cup type fittings, ANSI/ASME B16.22, factory cleaned and degreased for oxygen service by the fitting manufacturer in accordance with ASTM G93 Level C or better, as well as CGA G4.1 and NFPA-99. Factory nitrogen charged and bagged maximum 20 fittings per bag. Manufacturer to be ISO 9001 (or equivalent) and ISO 14001 or equivalent certified.</p>
XXVIII	<p>Malleable iron threaded fittings, ANSI B16.3. Fittings shall be 57 kg (125 lb minimum) for pressures less than 517 kPa (75 psi) and 136 kg (300 lb) for over 517 kPa (75 psi). Steam condensate shall be 136 kg (300 lb) for all pressures. Manufacturer to be ISO 9001 (or equivalent) and ISO 14001 or equivalent certified.</p>
XXIX	<p>Steel butt weld fittings, ANSI B16.9, ASTM A234, Grade WPB, long turn ells, ANSI B16.5 weld-neck (preferred) or slip-on forged carbon steel ANSI B16.5 flanges, except slip-on not permitted for steam applications above 103 kPa (15 psi), Weld-o-lets and thread-o-lets permitted only if branch at least 2 pipe sizes smaller than main. Cast iron flanges are not acceptable. 136 kg (Class 300) flanges required for steam pressures above 100 kPa (15 psi), 68 kg (Class 150) below 100 kPa. Fittings in accordance with system maximum working pressure ratings, ANSI B31.1 or B31.9 (as applicable) and of wall thickness not less than system piping. Manufacturer to be ISO 9001 (or equivalent) and ISO 14001 or equivalent certified.</p>

Fitting Type Designation	Pipe Fitting Specifications
XXX	Comply with requirement for pipe designation NN, (polyethylene fuel gas pipe and tubing) and to match pipe. ASTM D3261 butt fusion type except ASTM D2683 socket fusion may be used for 50 mm (2 in.) and smaller building service lines. ASTM D2513 and ASTM F2897. Pipe and fittings shall be compatible. Manufacturer to be ISO 9001 (or equivalent) and ISO 14001 or equivalent certified.
XXXI	Type 316L stainless steel socket weld fittings, ASTM A182, ANSI B16.11, wall thickness to match pipe and required system pressure ratings, Class 3000 minimum. Type 304L may be used for clean (not USP) steam unless otherwise required by application. Minimum cleanliness for high cleanliness systems is ASTM G93 Level C. Manufacturer to be ISO 9001 (or equivalent) and ISO 14001 or equivalent certified.
XXXII	Polyvinylidene fluoride (PVDF), infrared butt-fusion style, 21 CFR 177.1520 or 177.2510, virgin resin, ASTM D3222, ASTM D2837, ASTM D638, ASTM D2122, and ISO 10931 compliant, fitting wall thickness shall be SDR 21 (PN 16) 1586 kPa (230 psi), except that SDR 33 (PN10) working pressure rating not less than 1034 kPa (150 psig) may be used subject to system maximum pressure (including surge) requirements. Pressure rating shall be in conformance with ASTM D2837 hydrostatic design basis (not less than 50 year) and DIN 8077. Fittings shall be factory clean for high purity service and individually bagged and sealed. Extractables/static leach values of assembled piping and joints shall be per SEMI standard F57- F40. PVDF materials compliant with SEMI F57 standard are acceptable and PVDF listed to NSF-61 may also be used subject to conformance with these requirements. Fittings shall be compatible with and by same manufacturer as piping. Manufacturer to be ISO 9001 (or equivalent) and ISO 14001 or equivalent certified.
XXXIII	Reserved / Not Used
XXXIV	Cast iron threaded fittings, ANSI B16.4. Fittings shall be 57 kg (125 lb. minimum) for less than 517 kPa (75 psi) and 113 kg (250 lb minimum) for pressures above 517 kPa (75 psi). Steam condensate shall be 113 kg (250 lb minimum) for all pressures. Cast iron flanges are not acceptable. Manufacturer to be ISO 9001 (or equivalent) and ISO 14001 or equivalent certified.
XXXV	Steel socket weld fittings, ASTM A105, ANSI B16.11, wall thickness to match pipe and required system pressure ratings, Class 3000 minimum. Manufacturer to be ISO 9001 (or equivalent) and ISO 14001 or equivalent certified.
XXXVI	Wrought copper solder cup type fittings, ANSI/ASME B16.22 or wrought copper braze cup fittings ANSI/ASME B16.50. Fittings shall be listed for a working pressure of at least 4,200 kPa (610 psi) at 65°C (140°F) based on the annealed (post-braze) condition. Manufacturer to be ISO 9001 (or equivalent) and ISO 14001 or equivalent certified.
XXXVII	Schedule 40 drainage pattern PVDF, ASTM F1673, ASTM D3222, ASTM F1412. Manufacturer to be ISO 9001 (or equivalent) and ISO 14001 or equivalent certified.

Fitting Type Designation	Pipe Fitting Specifications
XXXVIII	<p>Double-ferrule type mechanical joint fitting as compatible and manufacturer approved for the service application; Type 316L stainless steel or brass to match tubing system; manufactured from barstock/forged material by a reputable manufacturer for this specialty joint type. Packaging, joint precautions, cleaning, and purging as appropriate to required service purity; not less than factory cleaned, degreased, and packaged. Sizes larger than 0.75 in. connected tubing outside diameter and any fuel gas or non-inert fluid shall be stainless steel fittings only and used with stainless steel tubing only. Manufactured components using this tubing connection (e.g., pneumatic components) shall be with stainless steel (not copper) tubing only, and with required minimum tubing wall thickness. Stainless steel fittings shall be heat code traceable. Single-ferrule configurations and other standard ferrule compression type joints are unacceptable. Manufacturer to be ISO 9001 (or equivalent) and ISO 14001 or equivalent certified.</p>
XXXIX	<p>ASTM C425 vitrified clay, drainage pattern fittings. Manufacturer to be ISO 9001 (or equivalent) and ISO 14001 or equivalent certified.</p>
XL	<p>Manufactured press-joint fitting of single press or double press joint design for use with a manufacturer-approved electromechanical pressing tool and exterior fitting circumferential jaw assembly to create a mechanical interlock between pipe and fitting with an elastomeric seal. NSF-61 compliant Type 316L (or CF3M) ASTM A312/ASTM A403 stainless steel. Systems for stainless steel shall either utilize standard ASTM A312 Schedule 10S stainless piping or shall be suitable for both standard ASTM A312 Schedule 5S and Schedule 10S piping (regardless of schedule used with initial installation). Schedule 10 minimum fitting wall thickness is required for size 75–100 mm (3–4 in.) Fitting interior surface finish shall in no case be less than ASTM A480 grade 2B smooth and reflective. Elastomer for lab/potable water systems shall be EPDM. Systems requiring single-manufacturer/proprietary piping or tubing are NOT permitted. The joint system shall meet performance requirements of IAPMO PS117, ICC ES-LC-1002, or FM approval guide 1920 and NSF-61. Assembled systems/joints shall be manufacturer-rated for a working pressure of at least 2,068 kPa (300 psig) at a temperature to include the maximum working temperature; and shall not fail at pressures below 112 Bar (1,625 psig). Systems requiring proprietary piping are unacceptable. Manufacturer to be ISO 9001 (or equivalent) and ISO 14001 or equivalent certified.</p>
XLI	<p>Manufactured press-joint fitting of single press or double press joint design for use with a manufacturer-approved electromechanical pressing tool and exterior fitting circumferential jaw assembly to create a mechanical interlock between pipe and fitting with an elastomeric seal. ANSI B16.51 wrought copper or lead-free copper alloy for copper systems. Fittings for copper systems 40 mm (1.5 in.) and smaller shall be rated for working pressure of at least 1380 kPa (200 psig) at a temperature to include the system maximum working temperature; and shall not fail at pressures below 112 Bar (1,625 psig). Elastomer for lab/potable water systems shall be EPDM. Elastomer for hydronic HVAC applications shall be FKM or EPDM. Systems requiring single-manufacturer/proprietary piping are NOT permitted. The joint system shall meet performance requirements of IAPMO PS117, ICC ES-LC-1002, or FM approval guide 1920 and NSF-61. Manufacturer to be ISO 9001 (or equivalent) and ISO 14001 or equivalent certified.</p>
XLII	<p>Pigmented polypropylene, infrared-butt fusion style, butt fusion, or socket fusion, ASTM D4101; 21 CFR 177.1520; ASTM D638; ASTM D2122; 100% virgin material with no rework; ISO 15494. Wall thickness not less than SDR 11 (PN10); working pressure rating not less than 1,034 kPa (150 psig) and subject to system maximum pressure (including surge) requirements. Pressure rating shall be in conformance with ASTM D2837 hydrostatic design basis (not less than 50-year) and DIN 8077. Pipe and fittings shall match and be by same manufacturer. Manufacturer to be ISO 9001 (or equivalent) and ISO 14001 or equivalent certified.</p>



Fitting Type Designation	Pipe Fitting Specifications
XLIII	Schedule 80 PVC, ASTM D1784 Class 12454B, ASTM D2467 socket type solvent cement fitting. Manufacturer to be ISO 9001 (or equivalent) and ISO 14001 or equivalent certified.
XLIV	ASME BPE compliant; ASTM A269; Type 316L stainless steel, ASTM A479 for bar stock; seamless or weld-bead cold-worked to finish condition, ASME SF4 15 to 20 Ra (or better) interior finish and electropolished, Minimum wall thickness shall not be less than connected piping/tubing. Fabrication of subcomponents for tees shall be by pulling, drilling, or notching the joining surfaces and pulsed TIG welding or GTAW orbital welding per ASME Section IX, heat tint-free. Chemical composition per Table I of ASTM A269 or ASME BPE. Sulfur range of 316L tube to be 0.005 to 0.012% for seamless and 0.005 to 0.017% for ERW. Fittings factory faced and squared for automatic orbital welding. Factory cleaned, passivated, sealed, and double bagged for UHP service. Post cleaning rinse water shall be 18 MΩ, 0.1 μm filters with maximum TOC=25 ppb and maximum <6 CFU/100 mL. Purge gas for fabrication and drying shall be 0.005 micron or better filtered cryogenic argon or nitrogen, with less than 1 ppm moisture, oxygen, or hydrocarbons. Fittings to be factory etched to include alloy and heat number or heat reference code, manufacturer, and shall be traceable back to original mill test report. Manufacturer to be ISO 9001 (or equivalent) and ISO 14001 or equivalent certified.
XLV	Perfluoroalkoxy (PFA) fitting, ultra-pure type factory clean and packaged; sanitary heat flare with PFA or PVDF nut; or sanitary flare-thru fluoropolymer hose design; or sanitary tri-clamp style; or sanitary fusion style fitting design; ASTM D3307; ASTM D2837 and not less than 1034 kPa (150 psig); virgin resin, 21 CFR 177.1550 or SEMI F57-0301. Where suitable PFA fittings are not readily available and subject to avoidance of deadleg; the use of an equivalent PVDF fitting may be accepted. Manufacturer to be ISO 9001 (or equivalent) and ISO 14001 or equivalent certified.
XLVI	Low alloy/micro-alloyed carbon steel, LMS 92-10 or LMS 97-20, axially swage elastic strain pre-load type fitting, metal to metal seals, permanent non-separable type joint only. ANSI B31.1 pressure and fatigue design compliant. Repair couplings or other fittings without stops are unacceptable.
XLVII	Flanged ductile iron with 40 mils. Factory-applied, coal-tar free abrasion-resistant ceramapure epoxy interior lining; ANSI/AWWA C110/A21.10, or C153, AWWA C210; AWWA C115. Ductile iron flanges only (no cast iron flanges). If piping is installed outdoors, exterior of fittings shall be provided with factory primed finish and painted white epoxy or polysiloxane or otherwise protected from substantial temperature variations between piping interior and exterior. Standard asphaltic exterior coating for indoor applications. Fittings shall be manufacturer prepared prior to lining/coating in accordance with lining manufacturer recommendations by certified applicators and holiday tested. Manufacturer to be ISO 9001 (or equivalent) and ISO 14001 or equivalent certified.
XLVIII	Ductile iron ANSI/AWWA C110/A21.10; Minimum Pressure Class 350; with factory-applied, 40 mils coal-tar free abrasion-resistant ceramapure epoxy interior lining; ANSI/AWWA C150, C151, AWWA C210; asphalt or fusion bonded epoxy exterior coating. AWWA C105 8-mil polyethylene encasement. Piping shall be manufacturer prepared prior to lining/coating in accordance with lining manufacturer recommendations by certified applicators and holiday tested. Manufacturer to be ISO 9001 (or equivalent) and ISO 14001 or equivalent certified.
XLIX	Type 316L stainless steel, axially swage elastic strain pre-load type fitting, ASTM A276 or ASTM A479; metal to metal seals, permanent non-separable type joint only. ANSI B31.1 pressure and fatigue design compliant. Repair couplings or other fittings without stops are unacceptable. Copper systems are not acceptable. Fitting shall be factory cleaned and packaged for oxygen service to ASTM G93 Level C or better when used for any clean gas system application (including lab gasses), however ASTM G93 Level D is acceptable for Lab compressed air.



Fitting Type Designation	Pipe Fitting Specifications
L	Type 316L double melt, VIM/VAR or AOD/VAR, ASTM A276, ASTM A479 and match the referenced tubing requirements. Minimum wall thickness shall not be less than connected piping/tubing. Fabrication of subcomponents for tees shall be by pulling, drilling, or notching the joining surfaces and pulsed TIG welding or GTAW orbital welding per ASME Section IX, heat tint-free. All fitting welds shall be inboard helium leak tested to $<1 \times 10^{-9}$ atm cc/sec.
LI	High density polyethylene, ASTM D3311 drainage pattern; meet or exceed ASTM F1412; of stress crack resistant grade and suitable for chemical waste and corrosive lab waste systems; meeting PE100RC with Cell Class PE445584C (or better), wall thickness corresponding to PN10 (SDR11) or greater, with 2% carbon black UV inhibitor and in conformance with CSA B181.3. 100% virgin material with no rework. Manufacturer to be ISO 9001 (or equivalent) and ISO 14001 or equivalent certified.

## Pipe Joint Type Designation and Joint Specifications

Joint Type Designation	Pipe Joint Specifications
a	Premolded neoprene compression gasket to ASTM C564.
b	ASTM C111 compression gasketed joints Provide with restraining gasket or ductile iron manufactured restraint where required due to thrust loads EPDM gaskets required for sanitary wastewater application. Not approved for above-ground use.
c	Heavy-duty shielded couplings listed to ASTM C1540 and either FM 1680 Class 1 or IAPMO IGC 237, with type 304 or 316 stainless steel shield and neoprene or approved equivalent virgin elastomeric gasket, no adhesives. Couplings shall be a minimum of 4-band type, unless FM1680 approved otherwise. Lateral bracing and thrust restraint is required for non-buried drainage piping sizes 125 mm (5 in.) and larger. Hubless style couplings are not acceptable for pipe size change (reducer) applications, use manufactured pipe fitting.
d	CISPI 310 type 304 or 316 stainless steel shielded neoprene coupling (approved for vent applications only), no adhesives. Hubless style couplings are not acceptable for pipe size change (reducer) applications, use manufactured pipe fitting.
e	ASTM B828 lead-free soldered joints with ASTM B32 Grade HB, Grade HN, or, approved equal solder that is also listed in Section 1 of ASTM B32. ASTM B813 high temperature water soluble flux. Air cooled only, no quenching. System should be rinsed thoroughly as soon as possible after soldering to prevent on-going flux activity. External surface flux residue shall also be removed.
f	Solvent cemented ASTM 2564 NSF listed cement and ASTM F656 NSF listed primer to IAPMO installation standard 9-95. "Hot" cements or wet-type fast dry cements shall not be utilized. Solvent cement joints only in dry ambient conditions and cement type appropriate for ambient temperature and pipe size. No less than 24 hour cure time for pressurized systems, and no less than 4 hours cure time for non-pressurized systems, regardless of size or cement type.
g	Hub and spigot caulked type with acid resistant packing and molten lead or manufacturer approved lead substitute suitable for post installation caulking or otherwise capable of locking the packing in accordance with manufacturer requirements.
h	Mechanical joint type with Teflon seal, neoprene outer gasket, and stainless steel shield as provided by pipe and fitting manufacturer.
i	Elastomeric sealed socket type joint by pipe and fitting manufacturer. Provide with manufacturers joint clamps (restraints) or engineered restraints for all nonburied applications, all sizes. NBR (nitrile rubber) or Viton (FPM/FKM rubber) gasket as appropriate: typically, EPDM for general sanitary, FPM/FKM for high temperature or corrosive applications, including with oil/grease. FPM/FKM or NBR required where vegetable oils may be present. EPDM not permitted for applications exposed to grease/oils. Austenitic stainless steel not permitted for drainage applications (except exposed trap arms) and for vents only.
j	Mechanically pressed joint utilizing manufacturer approved powered tool and jaws only as specifically approved for the pipe fitting, material, and size.
k	Threaded using American Standard for Pipe Threads, ANSI B2.1 with thread sealant or Mil Spec 27730A AND AA58092 PTFE premium density tape. Thread sealants shall be especially listed compatible with system contents, pipe materials, and operating conditions. Thread sealant (compound) is not permitted for medical/veterinary medical, high purity water, lab compressed air or other "clean" systems;-use appropriate PTFE tape for such applications. Degreased type PTFE tape required for oxygen, medical gas, and high purity water systems.

Joint Type Designation	Pipe Joint Specifications
L	<p>BCuP 3, 4, or 5 brazed joints per Section IX ASME BPVC or ANSI/AWS B2.2. High silver soft soldering (alloys that melt below 449°C (840°F) in lieu of brazing is not acceptable. No flux permitted for copper to copper joints. AWS A5.8 Bag-5 may also be used for copper to brass or bronze. Flux for copper to brass or bronze should be AWS A5.31 Class FB3-A or FB3-C. Lead free copper alloy fittings and valves (including cast) that contain a component that melts below 327°C (620°F), bismuth, or over 15% zinc shall not be brazed. BCuP 9 or BAg-5 shall be used for threaded copper adapters to prevent annealing.</p>
m	<p>ASTM D2657 socket fusion to practice method 1 using compatible pipe and fittings. Welders and method shall be qualified, and procedure in conformance with AWS B2.4 “Specification for Welding Procedure and Performance Qualification for Thermoplastics”. Mechanical joints are not permitted in waste or vent systems except for exposed or readily accessible traps and tailpiece connections to plumbing fixtures. Intermixing of different plastics, including different resins of the same broad plastic is not permitted.</p>
n	<p>Mechanical joint type with Teflon seal, neoprene gasket, and stainless steel shield over bead-to-bead or bead-to-plain end where required.</p>
o	<p>ASTM F1290 electrofusion with stainless steel coil and compatible pipe and fittings. Welders and method shall be qualified, and procedure in conformance with AWS B2.4 “Specification for Welding Procedure and Performance Qualification for Thermoplastics”. Mechanical joints are not permitted in waste or vent systems except for exposed or readily accessible traps and tailpiece connections to plumbing fixtures. Intermixing of different plastics, including different resins of the same broad plastic is not permitted.</p>
p	<p>ASTM D2657 butt fusion method using compatible pipe and fittings. Internal bead to be removed for drainage applications. Welders and method shall be qualified, and procedure in conformance with AWS B2.4 “Specification for Welding Procedure and Performance Qualification for Thermoplastics”. Mechanical joints are not permitted in waste or vent systems except for exposed or readily accessible traps and tailpiece connections to plumbing fixtures. Intermixing of different plastics, including different resins of the same broad plastic is not permitted. Comply with ASTM F3124 and general procedure recommendations of the Plastic Pipe Institute as appropriate to the material.</p>
q	<p>To match pipe material. Joint shall maintain pressure rating at least equivalent to that of piping material, shall be in conformance with piping system manufacturer recommendations, and subject to DTR approval. Slip joints, temporary joints, and joints that are unsuitable for non-accessible application are not typically acceptable, except for unconcealed non-pressurized non-hazardous applications.</p>
r	<p>Butt weld to ANSI B31.1 including requirements for welding procedure specifications and qualifications records in accordance with ASME Section IX and weld inspection in conformance with ANSI B31.1.</p>
s	<p>Tongue and groove, mortar sealed. Mortar type as required per site soils compatibility.</p>

Joint Type Designation	Pipe Joint Specifications
t	<p>AWWA/ANSI C111/A21.11 compression gasketed joints or AWWA/ANSI C110/A21.10 Type MJ mechanical joint. Where restraint is required, provide corrosion resistant epoxy coated ductile iron wedge-action gland restraint except that restraining gasket may be used in place of wedge action gland restraint where each piping joint is fully extended to engage the thrust restraint, and following manufacturer/DIPRA, and AWWA C600 requirements. Restraint gaskets shall not be used in lieu of wedge-restraints for lines subject to bi-directional flow (e.g., dual fed lines) unless thrust has otherwise been accommodated (e.g., arrangement of thrust blocks). Thrust blocks are required for lines serving fire protection unless waived. All bolts, nuts, and accessories AWWA C111/ANSI A21.1 compliant grade and type, Cor-Blue fluorocarbon coated low alloy high strength steel bolts/nuts mildly cathodic to the pipe are required for underground applications. Restraint shall be listed for piping working pressure (not calculated restraint force) of at least 3,102 kPa (450 psig), comply with UL standard 194, ductile iron construction and shall not be flow-direction dependent. NFPA-24 conformance additionally required for lines serving fire protection.</p>
u	<p>AWWA C-606 shoulder joint or AWWA C-606 cut groove method, each with NSF-61 listed gasket (typically halogenated butyl) comply with AWWA C600. Grooved couplings are not approved for changing pipe sizes, use reducer fitting.</p>
v	<p>AWWA C110 or C115 flanged with AWWA C111 full face flange-type special gasket type EPDM, for water systems, with not less than ASTM A307 grade B low carbon bolts, hardened washers, and heavy nuts. Only ductile iron flanges (not cast iron) permitted. Manufacturer flanged or machine threaded and machine tightened threaded or weld flange only. Plain-end pipe style flanges approved only for final connections shall include any required lateral restraint. Comply with AWWA C600. FKM may additionally be used but must be NSF-61 grade where used for potable water applications. Strict compliance with tightening sequence and flange joint assembly instructions of manufacturer is mandatory.</p>
w	<p>Sanitary mechanical joint (clean joint) such as sanitary ferrule or sanitary flare joints of crevice-free design including manufactured proprietary sanitary/clean joint style connections, utilizing material to match piping. Sanitary TC (tri-clamp) style joints are acceptable. Only approved elastomers that are compatible with system disinfectants are permitted, refer to corresponding <i>DRM</i> chapter.</p>
x	<p>Mechanical groove joint, roll-groove method only (cut groove not permitted); with ductile iron, galvanized ductile iron, or stainless steel coupling with coupling manufacturers approved bolts/nuts, except Type 316 stainless steel couplings are required for high humidity areas including mechanical rooms and any exterior piping. Stainless steel bolt and Type 651 Silicon Bronze heavy hex nuts are required for stainless couplings (to prevent galling). NSF-61 (cold and commercial hot) listed EPDM gasket. Couplings shall be standard/heavy-duty (not light or quick-assembly) type, rigid style (not flexible) and rated for working pressures of 2,758 kPa (400 psig) or greater with the applied pipe wall thickness. Comply with AWWA C600. Grooved couplings are not approved for changing pipe sizes, use reducer fitting.</p>
y	<p>Autogenous orbital weld in conformance with ASME BPE standard; welders qualified per ASME Section IX. Provide post weld system passivation per ASTM A380 and ASTM A967, inclusive of passivation test method suitable for potable/pharmaceutical water systems (e.g., test methods B, C, or F as defined in ASTM A967 or water wetting and drying method per ASTM A380) performed by a biopharmaceutical or semiconductor grade passivator and certification of process and results compliance. Weld purge gas filtered and from a cryogenic source, .003 micron filtered argon if joining a UHP system. Heat tint free. Joint precautions and quality assurance records as appropriate to system purity. Post installation passivation not required for heat-tint free welds serving inert UHP gas.</p>

Joint Type Designation	Pipe Joint Specifications
z	Sanitary and crevice free orbital weld in conformance with ASME BPE standard; complete joint penetration. Provide post weld system passivation per ASTM A380 and ASTM A967, inclusive of passivation test method suitable for potable water systems (e.g., test methods B, C, or F as defined in ASTM A967 or water wetting and drying method per ASTM A380) and certification. Provide post weld heat treatment where necessary to maintain corrosion resistance as appropriate to alloy selection and method (e.g., where autogenous method with duplex alloy is used). Weld purge gas filtered and from cryogenic source. Post-weld heat tint shall not exceed color 3 on AWS D18.1/AWS D18.2 scale.
aa	Infrared (IR) non-contact fusion (DVS 2207-6) using piping and fitting manufacture-approved automatic fusion machine and compatible pipe and fittings. Welders and method shall be qualified and procedure in conformance with AWS B2.4 “Specification for Welding Procedure and Performance Qualification for Thermoplastics” and shall be performed only by persons competent in high purity systems installation and following proper procedures to maintain system cleanliness. Intermixing of different plastics, including different resins of the same broad plastic is not permitted. Comply with ASTM F3124.
bb	BCuP 3, 4, or 5 brazed joints without flux following not less than NFPA 99 Level 1 system standards and ASSE series 6000 installation procedure, including clean, dry filtered nitrogen (or argon) purge, oxygen analyzer, purge gas flow meter, and compliance with. Section IX ASME BPVC or ANSI/AWS B2.2 (as modified per NFPA-99). A high quality particle filter shall be provided for purge gas. The use of a cryogenic source of purge gas is recommended, but in no case may purge gas be less than NF grade. Lead free copper alloy fittings and valves (including cast) that contain a component that melts below 327°C (620°F), bismuth, or over 15% zinc shall not be brazed. BCuP 9 shall be used for threaded copper adapters to prevent annealing.
cc	VCR metal gasket face-seal joint of stainless steel 316L VAR single melt (acceptable for inert gas only) AOD/VAR or VIM/VAR and electropolished is otherwise required. VCO joints are not acceptable. SEMI F20-0305; with stainless steel sealing gasket and gland; maximum 10µ in. Ra; clean and packaged to specified tubing/fitting standards and as appropriate to application. Gaskets shall not be re-used. Side-load type retained gaskets for UHP applications. Entire assembly (gland, body, nuts and seal) by a single manufacturer. Approved joint for final connections to appurtenances and equipment only.
dd	Double ferrule type high pressure engineered compression fitting; permitted only for use with tubing sizes 40 mm (1.5 in.) and smaller. This connection type is permitted only at final connections to equipment and accessible appurtenances. Sizes larger than 25 mm (1 in.) shall be pre-swaged using manufacturer approved tools. Installers shall receive manufacturer authorized training for proper joint assembly. Sizes larger than 1 in. are not acceptable for clean fluid systems due to required use of lubricants during assembly. Refer to footnotes and manufacturer guidelines for additional tubing wall thickness restrictions. Fitting material and ferrule hardness as appropriate for system tubing.
ee	Reserved/Not Used

Joint Type Designation	Pipe Joint Specifications
ff	AWS A5.8 BAg-5 with AWS Class FB3-A or FB3-C flux, except Type BCuP 3, BCuP 4, or BCuP 5 may be used for copper to copper joints but with no flux. Comply with Section IX ASME BPVC or ANSI/AWS B2.2. High silver soft soldering (alloys that melt below 449°C [840°F]) in lieu of brazing is not acceptable. Flux for copper to brass or bronze should be AWS A5.31 Class FB3-A or FB3C. Clean, dry (purity grade 4) filtered nitrogen (or argon) purge required for refrigeration applications. Lead free copper alloy fittings and valves (including cast) that contain a component that melts below 327°C (620°F), bismuth, or over 15% zinc shall not be brazed. BCuP 9 shall be used for threaded copper adapters to prevent annealing.
gg	Reserved/Not used
hh	ASTM F2620 butt fusion only, except ASTM F2620 socket heat fusion may be used for building service lines 50 mm (2 in.) and smaller provided the joint method is piping and fitting manufacturer approved and qualified to 49 CFR Part 192.283. Mechanical joints not permitted. Joints shall be made in full compliance with 49 CFR Part 192. Static electricity shall be discharged. Fusion tools shall be as approved by manufacturer. Fusion joints shall not be made to any piping that has been liquid-hydrocarbon permeated. Electrofusion joints are not acceptable. Comply with ASTM F3124. Welders additionally qualified per AWS B2.4
ii	SAE 45-degree or AWWA C800 flare; joint made only with a tool providing automatic release to prevent over-swaging. Application for liquid systems in sizes larger than 15 mm (0.5 in.) copper tube size shall be AWWA C800. Single ferrule style standard compression joints are not acceptable, except that a single readily accessible joint of single ferrule style may be used as part of or downstream of the at-fixture stop valve for tubing sizes 15 mm (0.5 in.) OD and smaller.
jj	AWWA C111 Mechanical Joint for underground use. May also be used for final connections to valves/equipment if provided with manufactured AWWA restraint. Additional glands or manufactured restraint and lateral restraint is required where used above ground. EPDM or neoprene gaskets required for sanitary wastewater application. Comply with AWWA C-600.
kk	Pressure-tight pipe clamp with integral stainless steel grip restraint for metallic piping, 304 or 316 stainless steel band and trim, manufacturer approved for specific piping outside diameter and application, Viton/FPM/FKM gasket. ASTM F1476, AWWA C227
LL	Elastomeric compression gasketed joints are acceptable for exterior foundation and interior subsoil (underslab) groundwater drainage piping only. ASTM C425, ASTM C412 for clay, ASTM D3139 for PVC.
mm	Mechanically extruded branch outlet in copper tube, per ASTM F2014 and ANSI/ASME B31.9, using manufacturer approved tool and BCuP 3, BCuP 4 or BCuP 5 brazing alloy, for copper to copper tubing only.



Joint Type Designation	Pipe Joint Specifications
nn	<p>AWWA C220 complete joint penetration (CJP) full penetration circumferential butt welded stainless steel with GTAW or TIG method; and filtered inert gas purge from a cryogenic source during welding. Welds shall be free of heat tint, crevices, cracks, overlaps, or cold laps; absolute minimization of field welding required. Welds shall have a smooth interior contour (ASME BPE Type) and root bead crown (weld convexity) shall not exceed 1.58 mm (0.0625 in.). Undercut shall not exceed 0.0313 in. or 10% wall thickness (whichever is less). Each welder to demonstrate proper welds, heat-tint free and free of crevices. Matching (316L) filler metal alloy. Post weld descaling and passivation required per ASTM A380 and ASTM A967, inclusive of passivation test method suitable for potable water systems (e.g., test methods B, C, or F as defined in ASTM A967 or water wetting and drying method per ASTM A380) and certification. Comply with ASME Section IX and AWS B2.1, welds performed only by experienced stainless steel piping welders. 100% weld inspection by a qualified weld inspector required for field welds (radiographic or borescopic to ASTM A1015) and random inspection for other welds. Orbital welding may also be used in conformance with ASME BPE standards. Post-weld heat tint shall not exceed color 3 on AWS D18.1/AWS D18.2 scale.</p>
oo	<p>Sanitary heat-flare joint made with fitting manufacturer approved heat based flare tool designed for use with sanitary heat-flare joints. Alternatively tri-clamp style joints, mini-sanitary tri-clamp joints, sanitary flare-thru hose, or sanitary heat fusion joints made by a qualified thermoplastics welder using weld machines as approved by the fitting manufacturer for the piping and fitting materials and not less than 1,034 kPa (150 psig) working pressure rating. Connection/joint quantity shall be absolutely minimized. Compression style joints, push-connect joints (with or without retaining bite -ring), and other non-sanitary joints or joints subject to blowout are unacceptable.</p>
pp	<p>Butt weld to ANSI B31.1 or ANSI B31.9 as required by application; including requirements for welding procedure specifications and qualifications records and weld inspection in conformance with ANSI B31.9 or B31.1. ANSI B31.1 is required for all medium and high pressure steam.</p>
qq	<p>Axial swage elastic strain preload type permanent non-separable joint of carbon steel or stainless steel to match piping material and made by personnel certified in proper joint assembly. Copper/brass fittings are not acceptable. Use on annealed tubing is not permitted. Joint shall not be placed within 254 mm (10 in.) of a braze or weld or on any portion of annealed tubing except provide greater distance as required by manufacturer. Joints and prefabricated materials shall be protected from torsion. Tube wall thickness to outside diameter ratio shall in no case be less than 0.07. The use of sealant in preparing joint ends is unacceptable. Design and installation (including but not limited to support and thermal flexibility) to comply additionally with manufacturers ANSI/ASME B31 design guide as applicable.</p>
rr	<p>Socket weld to ANSI B31.9 or ANSI B31.1 as required by application: including requirements for welding procedure specifications and qualifications records and weld inspection in conformance with ANSI B31.9 or B31.1. ANSI B31.1 is required for all medium and high pressure steam. Maintain 1.6 mm (0.0625 in.) clearance between pipe end and socket shoulder. Socket welding is not acceptable for corrosive fluids, or applications susceptible to stress crack induced corrosion or excessive fatigue at joint sockets, or for any piping larger than 50 mm (2 in.).</p>

# Section 6.4

## Thermal Insulation Systems

---

### Contents

#### 6.4.0 Introduction

#### 6.4.1 General Insulation Requirements

##### 6.4.1.1 Systems Not Requiring Insulation

#### 6.4.2 Insulation Material for Piping

#### 6.4.3 Insulation Thickness for Piping & Hot/Cold Equipment

#### 6.4.4 Supply, Return, and Outdoor Air Ductwork Insulation

## 6.4.0 Introduction

Thermal insulation is primarily used to limit heat or loss from the surfaces operating at temperatures above or below ambient temperatures. Insulation is also used to provide personnel protection, maintain condensation control, moderate freeze protection, noise control, and fire safety. This section applies to all types of NIH facilities, unless noted otherwise.

## 6.4.1 General Insulation Requirements

**A. Standards:** Minimum insulation levels for ductwork and piping systems shall equal or exceed the ASHRAE 90.1 and 90.2 standards. Exceeding the minimum levels dictated by energy codes is often justified as it may be cost-effective from the life cycle cost analysis as well as provide condensation control and personnel protection.

**B. Fire Hazard Rating:** Insulation materials approved for use in NIH buildings shall have a fire hazard rating not to exceed 25 for flame spread and 50 for smoke developed. All materials shall be factory tested as an assembly. Fire ratings shall be determined by the standard method of testing for surface-burning characteristics of building materials, ASTM E84, or NFPA Standard 255.

**C. Material Certification:** Insulation approved for use shall have a UL label or a certified test report from an approved testing laboratory.

**D. Insulation Installation:** Insulation installation shall be in accordance with the National Commercial & Industrial Insulation Standards published by the Midwest Insulation Contractors Association. Installation of all insulation systems shall be installed by skilled mechanics with certification of successful apprenticeship program or another craft training program certified by the Department of Labor, Bureau of Apprenticeship and Training.

**E. Timing of Insulation:** The A/E shall include in the design documents instructions to the contractor not to insulate the specified systems until all necessary tests have been successfully conducted for each component and insulated surfaces have been thoroughly cleaned and are in a dry state.

**F. Material Compatibility:** All adhesives, sealers, vapor barrier coatings, etc., used in conjunction with insulation shall be compatible with the material to which they are applied. Any cement, sealer, or coating used shall be resistant to vermin and mold and shall comply with volatile organic compound limits mandated in the sustainability section.

**G. Condensation Control:** The surface temperature of insulation shall be kept above the dewpoint of the surrounding air. In order to prevent surface condensation at high relative humidity levels, insulation thickness must increase dramatically.

**H. Protected Surfaces:** All insulation surfaces shall be durable and where exposed, protected from damage due to maintenance operations, vandalism, weather, and normal wear and tear.

**I. Personnel Protection:** Provide insulation on hot equipment, piping, and valves to limit contact temperature to 60°C (140°F).

**J. Weather Exposure:** Insulation exposed to weather shall be covered with a metal jacket made from 0.1 mm (0.016 in.) aluminum roll or sheet or 0.25 mm (0.01 in.) Type 304 stainless steel rolls or sheets.

**K. Continuous Insulation Parameters:** Insulation shall be continuous at all hangers, hanger rods, supports, sleeves, and openings. Vapor seal shall be provided for all cold surfaces and shall be continuous. Where support occurs below the insulation surface, the thickness shall be maintained over the support and extend sufficiently beyond the support to prevent condensation. Insulation shall be sealed at all termination points.

**L. Expansion/Contraction:** All insulation shall be arranged to permit expansion and contraction of systems without causing damage to the insulation or surface.

**M. Pipe Saddles/Welded Standoff:** High-density pipe saddle or welded pipe standoff shall be provided at all points of pipe support.

**N. Valves:** Valves shall be insulated up to and including bonnet, except for cold water valves, which shall be insulated over packing nut so as to permit removal for adjustment and repacking.

**O. Distortion/Sagging:** On ductwork or equipment, accessories shall be provided as required to prevent distortion and sagging of insulation. Welded pins, adhesive clips, and wire ties shall be provided as recommended by the manufacturers and SMACNA.

**P. Standing Seams/Metal Surfaces:** Duct and equipment insulation shall cover all standing seams and metal surfaces with full-thickness insulation.

**Q. Preformed Insulation System:** Preformed insulation systems shall be provided at pumps, valves, strainers, and access doors.

**R. Custom-Made Jacket:** Valves and specialties that are 75 mm (3 in.) and larger shall be insulated with custom-made durable jacket with straps and buckles to allow frequent removal and reinstallation without damaging the jacket.

**S. Pump:** Cold-water pumps shall be insulated with removable and replaceable square or rectangular cover consisting of full 1.25 mm (50 mils) thick aluminum metal jacket, reinforced at corners and edges and lined with insulation. Pumps with split casings shall be constructed with an insulated housing in two or more sections with the upper section removable for access to the casing. Lube fittings and drain valves shall extend outside insulated cover.

**T. Containment Space:** Insulation in containment space must be sealed at each end and must have a smooth and cleanable jacket.

**U. Metallic Component:** Metallic components used for the installation of insulation system shall be suitable for the intended environment and shall not corrode.

**V. Insulated Ductwork:** Preinsulated access doors are required for insulated ductwork.

#### 6.4.1.1 Systems Not Requiring Insulation

Insulation shall be omitted on the following systems and items:

1. Brass or copper pipe specified to be chrome plated (typically applies to toilet rooms)
2. Steam trap, steam-powered pump, steam condensate pump, and concealed relief piping from safety valves
3. All fire protection piping and components
4. All fuel oil piping and components
5. Exposed duct in an air conditioned space if duct is not prone to condensation
6. ASME stamp
7. Access plate of fan housing
8. Cleanout or hand-hold
9. Manufacturer's nameplate
10. Vibration-isolating connection
11. Sensor and miscellaneous devices such as duct-mounted smoke detectors

## 6.4.2 Insulation Material for Piping

**Exhibit 6.4: Insulation Material, Thickness, and Specifications for Piping and Ductwork** provides the minimum insulation standards for NIH projects and is intended as a guide for the services listed and other similar services not indicated. The A/E shall select the most suitable product for each individual service.

*Rationale: These requirements are intended to minimize thermal energy transfer, enhance the reliability, ease of maintenance, serviceability, and longevity of the affected equipment and systems.*

## 6.4.3 Insulation Thickness for Piping & Hot/Cold Equipment

The A/E shall select the piping cold equipment, and hot equipment insulation thickness per ASHRAE 90.1 or per the specifications noted in **Exhibit 6.4: Insulation Material, Thickness, and Specifications for Piping and Ductwork**, whichever is more stringent.

## 6.4.4 Supply, Return, and Outdoor Air Ductwork Insulation

**A. Ductwork Insulation:** The A/E shall select the ductwork insulation thickness per the specifications noted in [Exhibit 6.4: Insulation Material, Thickness, and Specifications for Piping and Ductwork](#).

**B. Weather Exposure:** When duct is exposed to weather, the A/E shall evaluate impact to the HVAC loads and determine additional insulation needs and submit appropriate calculations.

**C. Exterior Ductwork:** Insulated exterior flat ductwork shall have a sloped top surface to prevent ponding of water. The insulation system shall be rated to accommodate snow load.

**D. Ductwork Protection:** Outdoor supply and return ductwork exposed to weather shall have a field-installed aluminum jacketing/self-adhering waterproof membrane system over insulation. Alternatively, double-wall factory-fabricated insulated ductwork may also be specified.

**E. Exhaust Ductwork:** Exhaust ductwork is generally not insulated unless the duct passes through unconditioned space where duct temperature is below the dew-point temperature of the unconditioned space and prone to condensation.

# Exhibit 6.4

## Insulation Material, Thickness, and Specifications for Piping and Ductwork



## Piping Insulation Material and Specifications

Service	Material (1, 6, 7, 8)	Specification	Type	Class	Minimum Jacket (2, 3)	Vapor Barrier Required (10)
Chilled Water Supply, Return and Dual Temperature Piping Nominal 4.44°C (40°F)	Mineral Fiber (Fiberglass and Mineral Wool)	ASTM C 547	1	1	ASJ	Yes
	Cellular Glass	ASTM C 552	II	2	ASJ/Fabric reinforced or metal	No
	Polyisocynurate	ASTM C 518	III	1	ASJ/Fabric reinforced or metal or metal	Yes
	Faced Phenolic Resin	ASTM C 1126	III	1	ASJ/Fabric reinforced or metal	Yes
Heating Hot Water Supply & Return Max 121°C (250°F)	Mineral Fiber (Fiberglass and Mineral Wool)	ASTM C 547	I	1	ASJ	No
	Cellular Glass	ASTM C 552	II	2	ASJ/Fabric reinforced or metal	No
	Polyisocynurate	ASTM C 518	III	1	ASJ/Fabric reinforced or metal or	No
	Faced Phenolic Resin	ASTM C 1126	III	1	ASJ/Fabric reinforced or metal	No
Cold Domestic, Non-potable, and Laboratory Water Piping	Mineral Fiber (Fiberglass and Mineral Wool)	ASTM C547	I	1	Factory Applied, ASJ	Yes
Hot Domestic, Non-Potable, Tempered, and Hot Water Circulation Piping, Max 93°C (200°F)	Mineral Fiber (Fiberglass and Mineral Wool)	ASTM C547	I	1	Factory Applied, ASJ	No
Refrigerant Suction Piping Nominal 1.67°C (35°F)	Flex Elastomeric Cell'r	ASTM C 534	I		None	No
Compressed Air Discharge	Mineral Fiber (Fiber glass and Mineral Wool)	ASTM C 547	I	1	ASJ	No

Service	Material (1, 6, 7, 8)	Specification	Type	Class	Minimum Jacket (2, 3)	Vapor Barrier Required (10)
Sanitary and Clear Water Waste Lines and Drain Receptors Receiving Cold Condensate, Ice Machine, and Similar Wastes from Drain Inlet Source to Vertical Waste Stack or Point of Adequate Temperature Dilution	Mineral Fiber (Fiberglass and Mineral Wool)	ASTM C547	I	1	ASJ	Yes
	Flex Elastomeric Cell'r	ASTM C 534	I		None	No
Above-ground Horizontal and Vertical Storm Drain Piping and Drain Receptor.	Mineral Fiber (Fiberglass and Mineral Wool)	ASTM C547	I	1	ASJ	Yes
	Flex Elastomeric Cell'r	ASTM C 534	I		None	No
Above-ground Horizontal Overflow Storm Drainage (Overflow Roof Drain) Piping and Drain Receptor. Vertical Piping Need Not be Insulated.	Mineral Fiber (Fiberglass and Mineral Wool)	ASTM C547	I	1	ASJ	Yes
	Flex Elastomeric Cell'r	ASTM C 534	I		None	No
A/C and Cold Condensate Drain Located Inside Bldg.	Mineral Fiber (Fiberglass and Mineral Wool)	ASTM C547	I	1	Factory Applied ASJ	Yes
	Flex Elastomeric Cell'r	ASTM C 534	I		None	No
Medium Temperature Hot Water, Low Pressure Steam and Condensate Steam Relief Vents 94°C (201°F) to 176°C (349°F)	Mineral Fiber (Fiberglass and Mineral Wool)	ASTM C 547	I	1	ASJ	No
High Temperature Hot Water and Medium and High Pressure Steam and Condensate 177°C (350°F) and Higher	Mineral Fiber (Mineral Wool Only)	ASTM C 547 high temp	II	1	Metal or ASJ dependent on temperature	No
	Calcium Silicate (4)	ASTM C 533	I, II		Fabric reinforced, 8 oz. min. over ASJ	No
	Perlite	ASTM C 610	I		Fabric reinforced, 8 oz. min. over ASJ	No
Diesel Engine Exhaust	Calcium Silicate	ASTM C 533	I, II		Fabric reinforced, 8 oz. min. over ASJ	No
	Mineral Fiber (Mineral Wool Only)	ASTM C 547 high temp	II	1	Metal or ASJ dependent on temperature	No

**Notes:**

1. *Other insulation material may be acceptable. The A/E shall submit substitutions for approval. Materials shall comply with required flames/smoke spread requirements for the installed location.*
2. *Piping exposed to weather, located in parking garages, exposed in materials handling or transport areas less than 2.5 m (8 ft.) above the floor, or located where otherwise susceptible to damage or abuse shall be insulated and jacketed as specified above and covered with a 0.41 mm (0.016 in.) aluminum or stainless steel jacket in conformance with ASTM B209.*
3. *Jacket indicated is for typical indoor building service. Piping located in mechanical rooms or exposed areas less than 2.5 m (8 ft.) above the floor shall be provided with 0.75 mm (30 mil) thick PVC, or suitable metal (aluminum or stainless steel) jacket. Steam PRVs and general valves of sizes 152 mm (6 in.) and larger shall be provided with an approved industrial grade removable thermal insulation jacket system suitable for system application. Steam and condensate piping and located in autoclave, cage wash service areas shall be provided with 0.75 mm (30 mil) thick PVC or suitable metal jacket.*
4. *Perlite conforming to ASTM C610 may also be utilized. Calcium silicate and perlite are typically for mechanical/utility areas and not recommended for areas sensitive to potential water.*
5. *Insulation Inserts: ASTM C1126 closed cell phenolic foam blocks, or high density, high compressive strength insulation, certified chloride free per ASTM C795 and ASTM C-692 if applied with stainless steel piping systems. High temperature systems typically use calcium silicate.*
6. *Insulation applied to stainless steel piping systems shall be certified chloride-free per ASTM C795 and ASTM C-692.*
7. *Insulation applied in areas subject to excessive moisture shall be moisture resistant and/or fitted with approved sealed jacket. Insulation subject to compressive loads (including areas where piping is likely to be walked or crawled upon) shall be of approved type, suitable for anticipated compressive forces.*
8. *Insulation located in areas considered clean, sterile, or otherwise requiring special cleanliness characteristics shall be certified for use in food processing areas and cleanroom areas and submitted for prior approval.*
9. *Pipes exposed to weather require heat trace. Heat trace shall have monitor/alarm and powered from emergency power source.*
10. *Vapor barrier shall have maximum permeance of 0.02 perm-in when tested according to ASTM E 96/E 96M.*

## Minimum Thickness of Piping Insulation

Service	Material (1, 2, 3,4)	Nominal Pipe Sizes, mm (in.)				
		13 to 19 (0.5 to 0.75)	25 to 32 (1 to 1.25)	38 to 75 (1.5 to 3)	100 to 150 (4 to 6)	200 (8) and larger
Chilled Water	Cellular Glass	25 (1)	38 (1.5)	50 (2)	50 (2)	62 (2.5)
Indoor Supply & Return Nominal 4°C (40°F)	Mineral Fiber Note 3	25 (1)	25 (1)	38 (1.5)	38 (1.5)	38 (1.5)
Chilled Water	Cellular Glass	25 (1)	75 (3)	75 (3)	75 (3)	100 (4)
Outdoor & Aboveground Supply & Return Nominal 4°C (40°F)	Polyisocyanurate  Faced Phenolic Foam	25 (1)	50 (2)	50 (2)	62 (2.5)	62 (2.5)
Chilled Water In Tunnels Supply & Return Nominal 4°C (40°F)	Cellular Glass	50 (2)	75 (3)	75 (3)	75 (3)	100 (4)
Heating Hot Water Indoor Supply & Return, Heated Oil Max 121°C (250°F)	Mineral Fiber Note 3	38 (1.5)	38 (1.5)	50 (2)	50 (2)	88 (3.5)
Heating Hot Water Outdoor Supply & Return Max 121°C (250°F)	Calcium Silicate Cellular Glass Polyisocyanurate Faced Phenolic Foam	75 (3)	75 (3)	100 (4)	100 (4)	N/A
Cold Domestic, Non- Potable, and Laboratory Water Piping – Indoor	Mineral Fiber Note 3	25 (1)	25 (1)	25 (1)	25 (1)	25 (1)
Indoor Cold Waste/ Storm/Clear Water Waste/Overflow/Cold Condensate Lines and Drain Receptor.	Mineral Fiber Note 3  Flex Elas Cell'r	13 (0.5)	25 (1)	25 (1)	25 (1)	25 (1)
Hot Domestic, Non- Potable, Tempered, and Hot Water Circulation Piping Max 60°C (140°F)	Mineral Fiber Note 3	25 (1)	25 (1)	25 (1)	38 (1.5)	38 (1.5)

Service	Material (1, 2, 3,4)	Nominal Pipe Sizes, mm (in.)				
		13 to 19 (0.5 to 0.75)	25 to 32 (1 to 1.25)	38 to 75 (1.5 to 3)	100 to 150 (4 to 6)	200 (8) and larger
Hot Domestic, Non-Potable, Tempered, and Hot Water Circulation Piping 61°C (142°F) to 93°C (200°F)	Mineral Fiber Note 3	25 (1)	25 (1)	38 (1.5)	38 (1.5)	38 (1.5)
Refrigerant Suction Piping 1°C (35°F)	Flex Elast Cell'r	25 (1)	38 (1.5)	38 (1.5)	38 (1.5)	N/A
Compressed Air Discharge, Steam, and Condensate Return 94°C (201°F) to 121°C (250°F)	Mineral Fiber Note 3	38 (1.5)	38 (1.5)	50 (2)	75 (3)	88 (3.5)
Steam – Indoors 122°C (251°F) to 176°C (349°F)	Mineral Fiber Note 3	38 (1.5)	62 (2.5)	75 (3)	100 (4)	100 (4)
Steam – Indoors 177°C (350°F) to 260°C (500°F)	Mineral Fiber (Mineral Wool Only)	62 (2.5)	75 (3)	75 (3)	100 (4)	100 (4)
	Calcium Silicate	N/A	100 (4)	100 (4)	150 (6)	150 (6)
Steam and Condensate – Outdoor & Tunnels	Calcium Silicate	N/A	100 (4)	100 (4)	150 (6)	150 (6)
Diesel Engine Exhaust	Calcium Silicate	N/A	N/A	N/A	100 (4)	100 (4)
	Cellular Glass	N/A	N/A	N/A	125 (5)	150 (6)

Notes:

1. Insulation thicknesses are minimum requirements. Comply with current energy conservation and code requirements, and as necessary to protect from unacceptable heat transfer, condensation, freezing, etc.
2. 13 mm (0.5 in.) thick insulation acceptable for domestic/lab plumbing water drops within interior partitions where necessary to maintain partition wall thickness.
3. Mineral Fiber represents Fiberglass and Mineral Wool. Steam vent piping below 2 m (6.56 ft.) shall be insulated for burn protection with 50 mm (2 in.) mineral fiber insulation.

## Insulation Thickness for Hot Equipment

Pressure and Temperature Range for Equipment Handling Steam or Other Media	Material <sup>a</sup>	Insulation Thickness mm (in.)
138 kPa (20 psi) 126°C (259°F)	Rigid mineral fiber	50 (2)
	Cellular glass	75 (3)
145–1,379 kPa (21–200 psi) 126–198°C (260–388°F)	Rigid mineral fiber	75 (3)
	Calcium silicate/perlite	100 (4)
	Cellular glass	100 (4)

<sup>a</sup>Other insulation materials may be acceptable. The A/E shall submit a variance request for approval.

## Insulation Thickness for Cold Equipment

System Temperature of Cold Equipment	Material <sup>a</sup>	Insulation Thickness mm (in.)
2–6°C (35–60°F)	Cellular glass	38 (1.5)
	Flexible elastomeric cellular	32 (1.25)
-18–1°C (0– 34°F)	Cellular glass	75 (3)
-34– -17°C (-29–1°F)	Cellular glass	88 (3.5)

<sup>a</sup>Other insulation materials may be acceptable. The A/E shall submit a variance request for approval.

## Insulation Minimum Thickness and Density for Supply, Return, and Outdoor Air Ductwork<sup>a</sup>

Insulation Type	Indoors & Concealed	Indoors & Exposed	Outdoors & Exposed to Weather
Blanket – Flexible mineral fiber/fiberglass ASTM C 1290, Type III, FSK faced	50 mm (2 in.) thick 24 kg/m <sup>3</sup> (1.50 lb/ft <sup>3</sup> )	N/A	N/A
Board – Rigid mineral fiber/fiberglass ASTM C 612, Type IA, and IB, FSK faced	40 mm (1.5 in.) thick 48 kg/m <sup>3</sup> (3 lb/ft <sup>3</sup> )	50 mm (2 in.) thick 48 kg/m <sup>3</sup> (3 lb/ft <sup>3</sup> )	75 mm (3 in.) thick 48 kg/m <sup>3</sup> (3 lb/ft <sup>3</sup> )

<sup>a</sup>Other insulation materials may be acceptable. The A/E shall submit a variance request for approval.



# Section 6.5

## Noise and Vibration

---

### Contents

6.5.0 Introduction

6.5.1 General Design Considerations

6.5.2 Room Noise Levels

6.5.2.1 Noise and Vibration In/Near Small Animal Rooms

6.5.3 Outdoor Noise Control

6.5.4 Ductwork and Fan Sound Control

6.5.5 Machinery Sound-Level Criteria

6.5.6 Piping and Ductwork Vibration-Isolation Criteria

6.5.7 Machinery Vibration Criteria

## 6.5.0 Introduction

The primary objective of the acoustical design of HVAC systems is to ensure that the spaces are not unacceptably affected by the HVAC system-related noise or vibration. This section applies to all types of NIH facilities, unless noted otherwise.

### 6.5.1 General Design Considerations

**A. Cooperation between Disciplines:** Proper acoustical design requires broad engineering cooperation in the areas of architecture, structural engineering, mechanical engineering, electrical engineering, and acoustics.

**B. Mechanical System/Equipment:** The design team shall work together to determine the mechanical system-type and preliminary mechanical equipment selection to allow for preliminary noise and vibration analysis. Mechanical room sizing is critical to ensure equipment is not squeezed into restricted space. Restricted space may also force a mechanical engineer into selecting small and inefficient equipment. Similar problems occur at duct shafts where small duct shafts result in under-sized ducts having excessive duct velocities.

**C. Space Planning:** Space planning is also critical to ensure noisy equipment is located as far as possible from critical noise and vibration sensitive areas and proper wall, slab construction, and insulation measures are provided.

**D. Noise and Vibration Control Design:** Noise and vibration control design shall begin early during the design process and be integrated into the overall building design.

*Rationale: Often HVAC acoustical design features such as duct silencers and vibration isolators are added late in the construction document phase after the mechanical engineer has completed the HVAC design and long after the architect has sited the equipment and the structural engineer has completed the structural system. This results in poor integrated design and problematic acoustics and vibrations.*

## 6.5.2 Room Noise Levels

**A. Acoustical/Sound Analysis:** Acoustical analysis shall be provided to ascertain compliance to the noise criterion (NC) levels listed in [Table 6.5.2](#). The sound analysis begins with the supply fan, return, or exhaust fan and includes ductwork, the terminal units, and diffusers.

**B. Background NC Noise Levels:** [Table 6.5.2](#) lists the maximum allowable background NC noise levels for a variety of spaces. NC levels are based on rooms not being occupied and with all user equipment off.

### 6.5.2.1 Noise and Vibration In/Near Small Animal Rooms

**A. Animal Distress:** Excessive noise is recognized as a source of distress in animals. Excessive or sudden high-frequency noise (ratio between background and peak levels is above 30 dB) due to construction or repair activity near small animal rooms should be avoided. Vibration from construction equipment such as the operation of a jackhammer should also be avoided. Utilities and certain scientific equipment generate noise outside of the human hearing and may also impact research.

*Rationale: Excessive noise interferes with and affects the auditory system, maternal and fetal health, and sleep levels and patterns of small animals, causing subclinical pathology that can change the outcome of research studies. Deleterious subclinical effects of noise on lab animals include stress response and immune system anomalies. Excessive vibration levels may cause more adverse effects in small animals because resonance frequencies of small animals may match closely those of certain types of equipment such as jackhammers. Rodents are nocturnal and thus sleep during the day when construction noise will affect them most.*

## 6.5.3 Outdoor Noise Control

**A. Compliance:** Outdoor and environmental noise shall comply with federal and county regulations, ordinances, municipal codes, and mandates on community noise.

**B. Outdoor Equipment:** Noise from cooling towers, exhaust fans, air-cooled chillers, water-cooled chillers, roof-top HVAC equipment, and similar equipment shall be evaluated to meet property boundary noise restrictions and determine if acoustical treatment is required.

## 6.5.4 Ductwork and Fan Sound Control

**A. HVAC Design:** The HVAC design shall include all systems necessary to control noise transmitted through the ductwork system. Proper equipment and device selection, lower duct velocities, in-duct attenuation, breakout attenuation, and self-noise generated from devices should be considered when selecting, sizing, and routing of ductwork systems.

*Rationale: Most HVAC noise complaints are associated with selecting and integrating fans properly with the air-distribution system.*

**B. Lined Ductwork:** Duct lining is not permitted at any NIH facility for either acoustical or insulation purposes.

*Rationale: Lined ductwork is prone to bacterial growth, which is impossible to sanitize once it is contaminated.*

**C. Silencers:** Silencers or sound attenuators shall not be used as a substitute for poor equipment selection or improper duct design. Dissipative or absorptive silencers with or without films are not allowed in HVAC systems at any NIH facility; reactive or packless silencers are however acceptable in air handling and ductwork systems. Additionally, cross-talk silencers for speech privacy fitted with non-fibrous material or film-lined dissipative type are permitted in noise-sensitive areas.

*Rationale: Dissipative silencers use absorptive media such as fiberglass, which is prone to bacterial growth. Film liners are ineffective over time because they degrade and expose the airstream to absorptive media. Cross-talk silencers are not subject to high velocities and therefore have a lower risk of liner degradation.*

**Table 6.5.2 Required Maximum Noise Levels**

Area	Maximum Noise Level NC
Auditoriums	20–25
Conference rooms, lecture rooms	25–35
Executive offices	30–35
Classrooms	30–35
Open-plan offices <sup>c</sup>	35–45
Dining rooms and lobbies	40
Central sterile food service/ serving	45
Kitchen, lockers, warehouse, and shops	50
Corridors and support areas	45
Operating rooms <sup>c</sup>	40–45
Research laboratories <sup>c</sup>	40–45
Research animal housing areas <sup>a,b,c,d</sup>	45

<sup>a</sup>When evaluating the noise levels in research animal housing areas, it is necessary to consider both the people and the animals in these spaces. A maximum noise level of NC-45 shall be maintained based on an empty room.

<sup>b</sup>The above NC values may be increased for ventilated cage racks or user equipment installed within occupied spaces as approved by the chief veterinarian. The acoustical consultant shall determine specific requirements for animal research areas on a per project basis with the chief veterinarian.

<sup>c</sup>For adequate speech intelligibility at a distance of 1.8 m (6 ft.), with normal voice effort, the operational background noise spectrum in the room shall be limited to NC-45. As the bulk of speech intelligibility is in the 500–4,000 Hz octave bands, sound levels shall also be lower in that same range.

<sup>d</sup>The above NC values may be increased for non-human primates, dogs, and other noisy animals as approved by the chief veterinarian. The acoustical consultant shall determine specific requirements for animal research areas on a per project basis with the chief veterinarian.

Silencer pressure drop shall not exceed 87 Pa (0.35 in. w.g.). Where required provide stainless steel silencers on ARFs, fume hoods, ducted BSCs, and biocontainment exhausts.

*Rationale: Silencer use adds to the capital cost of projects and increases energy consumption from the added pressure drop through the silencer. Placement of silencers in the proximity of the fans and duct fittings or excessive duct velocities may cause excessive self-noise and high-pressure drop.*

**D. Dampers:** Locate dampers to enable system balancing as far upstream as possible from spaces served by the system. Throttling dampers at diffusers may be used for small volume adjustments not requiring more than 25 Pa (0.1 in. w.g.).

*Rationale: A damper at the diffuser has the potential of adding 5–15 dB depending on the pressure drop.*

**E. Offsets:** Avoid offsetting flexible ductwork connection to diffusers. Offsets cause air turbulence that can increase the NC rating of the diffuser.

**F. Terminal Locations:** Terminals serving noise-sensitive spaces such as conference rooms, executive offices, etc., shall be located in corridors rather than above offices.

**G. Fan Efficiency:** In general, fans shall be selected close to the peak efficiency point on the fans curve, but away from the stall region. For fans operated by VFD at partial loads or when two fans are operated in parallel at 50% capacity, low-frequency noise problems could result in stall if the original fan selection is oversized.

*Rationale: If the fan operates to the right of the maximum efficiency curve, high-frequency noise is increased – to the left of the maximum efficiency curve, low frequency noise is increased.*

**H. Fan Airflow:** Airflow into and out of the fan shall avoid swirling and turbulence to minimize effects on the system.

**I. Airflow Obstructions:** Avoid placing duct fittings or other airflow obstructions close to the fan inlet or discharge.

**J. Terminal Unit Sound Attenuation:** Silencers used in terminal unit application shall be based on the estimated procedure in accordance with the ASHRAE Standard 885 (Procedure for Estimating Occupied Space Sound Levels in the Application of Air Terminals and Air Outlets).

## 6.5.5 Machinery Sound-Level Criteria

**A. Maximum Noise Level:** The maximum allowed noise levels from the mechanical system equipment shall not exceed 85 dBA – weighted scale, continuous, or intermittent.

**B. Acoustical Treatment:** Laboratory equipment such as compressed air, vacuum, and similar equipment located within laboratory spaces shall be considered for acoustical treatment if noise levels exceed 60 dBA. Dust-collection equipment located indoors shall also be considered for acoustical treatment.

*Rationale: Providing acoustical treatment on noisy equipment allows for speech intelligibility using a normal speaking voice.*

## 6.5.6 Piping and Ductwork Vibration-Isolation Criteria

Piping and ductwork vibration isolation requirements shall be edited by the A/E to accommodate project-specific requirements for piping and ductwork. Vibration-sensitive area requirements shall be based on specific equipment requirements.

**A. Vibration isolators shall be provided as follows:**

- 1. High Pressure Ductwork:** For greater than 1.494 kPa (6 in. w.g.) with a distance of 15 m (50 ft.) from fans, exhausters, and blowers

2. **Piping Connected to Vibration-Isolated Machinery:** For a distance of 15 m (50 ft.) or 50 pipe diameters, whichever is greater
3. **Steam Pressure-Reducing Valves:** For connected piping with a distance of 15 m (50 ft.) or 50 pipe diameters, whichever is greater
4. **Condenser Water:** For the full length of the piping. Implementation of this requirement is optional for condenser water for cold rooms, small computer room units, and small process chillers when motors are smaller than 7.5 kW (10 hp)
5. **Chilled and Hot Water Piping:** For risers from pumps and for the first 6 m (20 ft.) of the branch connection of the main supply and return piping at each floor. Implementation of this requirement is optional on systems coming from floor-mounted pumps on vibration isolators with flex connectors.

**B. Water and Steam Distribution Piping:** Resiliently support piping with combination spring and neoprene isolation hangers. Provide spring elements with 16 mm (0.625 in.) static deflection; install the hanger with spacing so that the first harmonic natural frequency is not less than 360 Hz. Provide double-deflection neoprene elements. Ensure a deflection equal to the equipment-isolation static deflection for the first two isolation hangers, from any rotating equipment, and for piping systems smaller than 100 mm (4 in.). For the first four piping isolation hanger supports, from rotating equipment, for piping systems 100 mm (4 in.) and larger use resilient hanger-rod isolators at a fixed elevation regardless of load changes. Incorporate an adjustable preloading device to transfer the load to the spring element within the hanger mounting after the piping system has been filled with water.

**C. Pipe Risers:** Provide pipe-riser supports with bearing plates and two layers of 6 mm (0.25 in.) thick ribbed or waffled neoprene pads which shall not be loaded more than 345 Pa (50 psi). Separate isolation pads with 6 mm (0.25 in.) steel plates. Weld pipe riser clamps at anchor points to anchor mountings, which shall be rigidly fastened to the steel framing.

**D. Duct Risers:** Provide duct-riser supports within shafts with suitable bearing plates and two layers of 6 mm (0.25 in.) thick ribbed or waffled neoprene pads

loaded to not more than 345 Pa (50 psi). Separate isolation pads with 6 mm (0.25 in.) steel plate.

**E. No Rigid Connections:** There shall be no rigid connections between the building and the vibration isolation system and its components.

**F. Misalignments Between Pipes:** Using vibration isolation to correct misalignments between pipes is not allowed.

**G. Thermal/Mechanical Movement:** Provide eye-bolts or swivel joints for pipe hangers to permit pipe thermal or mechanical movement without angular misalignment of a hanger vibration isolator.

**H. Pressure Fluctuation:** Provide isolating hangers and supports at modulating, pressure-reducing, or control valves that induce pressure fluctuation.

**I. Spring Thrust Restraint:** Provide spring thrust restraint on all duct flexible connectors where they may be subject to greater than 500 Pa (2 in.) static pressure.

**J. Vibration-Isolation Criteria:** All piping and ductwork should be vibration isolated including flexible connections where rigid elements cross from non-sensitive to vibration-sensitive spaces. Vibration-sensitive areas include electron microscope rooms, microsurgery, and certain imaging rooms.

---

## 6.5.7 Machinery Vibration Criteria

**A. Selection Criteria:** Selection of proper vibration isolation for machinery is critical for controlling structure-borne sound transmission. The design of proper vibration isolation types for each piece of equipment depends on the equipment type, nature of vibration, type of drive, rpm, horsepower, mass, location of equipment relative to vibration-sensitive areas, and mass of the building structure supporting the isolated equipment, etc.

**B.** Vibration isolator types and minimum static deflection shall follow the requirements listed in [Table 6.5.7 Vibration Isolator Types and Minimum Static Deflection for Machinery](#). The A/E shall edit these requirements to accommodate specific projects. Isolator deflections shall be equal to or greater than the static deflection of the vibration isolators provided for connected machinery.

**Table 6.5.7 Vibration Isolator Types and Minimum Static Deflection for Machinery**

Equipment	Column Spacing <sup>a</sup>					
	Slab on-grade and 0–9 meters (0–30 ft.)		9.1–12 meters (31–40 ft.)		12.1–15 meters (41–50 ft.)	
	Isolator Type <sup>c</sup>	MSD <sup>b</sup> mm (in.)	Isolator Type <sup>c</sup>	MSD <sup>b</sup> mm (in.)	Isolator Type <sup>c</sup>	MSD <sup>b</sup> mm (in.)
Absorption refrigeration machines	S-R	25 (1)	S-R	45 (1.75)	S-R	45 (1.75)
Centrifugal chillers or heat pumps						
Hermetic type	S-R	45 (1.75)	S-R	45 (1.75)	S-R	69 (2.75)
Open type	S-I	45 (1.75)	S-I	45 (1.75)	S-I	69 (2.75)
Reciprocating air/refrig compressors						
500–750 rpm	S-R	45 (1.75)	S-R	69 (2.75)	S-R	94 (3.75)
751 rpm and up	S-R	45 (1.75)	S-R	69 (2.75)	S-R	94 (3.75)
Reciprocating chillers or heat pumps						
500–750 rpm	S-R	45 (1.75)	S-R	62 (2.5)	S-R	88 (3.5)
751 rpm and up	S-R	38 (1.5)	S-R	62 (2.5)	S-R	88 (3.5)
Packaged boilers	S	25 (1)	S	45 (1.75)	S-R	69 (2.75)
Closed coupled pumps						
Up to 3.7 kW (5 hp)	S-I	25 (1)	S-I	45 (1.75)	S-I	45 (1.75)
5.6 kW (7.5 hp) and larger	S-I	45 (1.75)	S-I	45 (1.75)	S-I	69 (2.75)
Base mounted pumps						
Up to 44.7 kW (60 hp)	S-I	45 (1.75)	S-I	45 (1.75)	S-I	69 (2.75)
5.9 kW (75 hp) and larger	S-I	69 (2.75)	S-I	69 (2.75)	S-I	94 (3.75)
Cooling towers and evaporative condensers	S with deflections specified for centrifugal blowers when springs are supported on beams. Use deflection listed for column supported floors with up to 9 m (30 ft.) column spacing when springs are located on columns or bearing walls.					
Factory-assembled air handling equipment AH, AC, and HV units <sup>d</sup>						
Suspended units <sup>d</sup>						
Up to 3.7 kW (5 hp)	H	25 (1)	H	25 (1)	H	25 (1)
5.6 kW (7.5 hp) and up to 29.8 kW (40 hp) – Up to 400 rpm	H	45 (1.75)	H	45 (1.75)	H	45 (1.75)
5.6 kW (7.5 hp) and up to 29.8 kW (40 hp) – Over 400 rpm	H	25 (1)	H	45 (1.75)	H	69 (2.75)
37.3 kW (50 hp) and larger	H	45 (1.75)	H	69 (2.75)	H	88 (3.5)
Floor-mounted units <sup>d</sup>						
Up to 3.7 kW (5 hp)	S	25 (1)	S	25 (1)	S	25 (1)
5.6 kW (7.5 hp) and up to 29.8 kW (40 hp) - Up to 400 rpm	S-R	45 (1.75)	S-R	45 (1.75)	S-R	45 (1.75)
5.6 kW (7.5 hp) and up to 29.8 kW (40 hp) – Over 400 rpm	S-R	25 (1)	S-R	45 (1.75)	S-R	69 (2.75)
37.3 kW (50 hp) and larger	S-R	45 (1.75)	S-R	69 (2.75)	S-R	88 (3.5)



Equipment	Column Spacing <sup>a</sup>					
	Slab on-grade and 0–9 meters (0–30 ft.)		9.1–12 meters (31–40 ft.)		12.1–15 meters (41–50 ft.)	
	Isolator Type <sup>c</sup>	MSD <sup>b</sup> mm (in.)	Isolator Type <sup>c</sup>	MSD <sup>b</sup> mm (in.)	Isolator Type <sup>c</sup>	MSD <sup>b</sup> mm (in.)
Centrifugal blowers <sup>d</sup>						
175–224 rpm	S-R	119 (4.7)	S-R	119 (4.7)	S-R	119 (4.7)
225–299 rpm	S-R	94 (3.75)	S-R	94 (3.75)	S-R	94 (3.75)
300–374 rpm	S-R	69 (2.75)	S-R	94 (3.75)	S-R	94 (3.75)
75–499 rpm	S-R	69 (2.75)	S-R	88 (3.5)	S-R	94 (3.75)
500 rpm and higher	S-R	45 (1.75)	S-R	69 (2.75)	S-R	94 (3.75)
Utility fans <sup>d</sup>						
Suspended	H with deflections specified for centrifugal blowers, but not to exceed 69 mm (2.75 in.)					
Floor-mounted	S-R with deflections specified for centrifugal blowers, but not to exceed 69 mm (2.75 in.)					
Internal combustion engines and engine driven equipment – 750 rpm and over	S	38 (1.5)	S	62 (2.5)	S	88 (3.5)
Electrical transformers						
Suspended units	H	25 (1)	H	25 (1)	H	25 (1)
Floor-mounted units	NP	10 (0.35)	NP	10 (0.35)	NP	10 (0.35)

**Abbreviations:** MSD = Minimum Static Deflection; AH = Air Handling; AC = Air Conditioning; HV = Heating and Ventilating

<sup>a</sup>Table applies to 100–200 mm (4–8 in.) thick slab on-grade or column supported. This table applies to non-seismic zones.

<sup>b</sup>These are certifiable minimum static deflections, not manufacturer's nominal deflections.

<sup>c</sup>Equipment vibration isolation schedule designations. Hyphenated designations are combinations of the following:

H = Spring isolator hangers for suspended equipment and piping. Where required, provide with adjustable preloading devices.

I = Concrete inertia bases with steel forms

NP = Neoprene pads

R = Welded structural steel rail for equipment mounts

S = Freestanding spring isolators (floor-mounted equipment)

SX = Protected/housed freestanding spring isolators with adjustable cushioned vertical stops and

cushioned horizontal stops. Protected spring isolators SX may be substituted wherever S is specified and meets all requirements.

<sup>d</sup>Fans:

1. When fan motors are 44.7 kW (60 hp) or larger, use the deflection requirements for the next wider column spacing. Except for equipment slab on-grade, a minimum of 62 mm (2.5 in.) deflection shall be used unless larger deflections are specified in the centrifugal blower table.
2. Provide sway brace isolators for tubular centrifugal and axial fans when the fan pressure exceeds 1 kPa (4 in. w.g.).
3. Provide concrete inertia bases "I" in lieu of welded structural steel rails "R", when the fan pressure exceeds 1 kPa (4 in. w.g.).
4. Provide thrust restraints to eliminate the need for or reduce the magnitude of inertia mass when the mass is only used to reduce the displacement effects of the thrust. Provide thrust restraints for high-static pressure fans, over 1.5 kPa (6 in. w.g.) static pressure, and other thrust-producing machinery.

# Section 6.6

## BSL-3 & ABSL-3 Biocontainment

---

### Contents

- 6.6.0 Introduction
- 6.6.1 Design Requirements
- 6.6.2 Supply Air Systems
- 6.6.3 Ventilation Rates in BSL-3 Laboratories
- 6.6.4 Ventilation Rates in ABSL-3 Laboratories
- 6.6.5 Relative Room Pressurization
- 6.6.6 Anterooms
- 6.6.7 Exhaust Air Systems
- 6.6.8 Air Filtration
- 6.6.9 Isolation Dampers
- 6.6.10 Autoclaves
- 6.6.11 Service Access Panels and Mechanical Spaces
- 6.6.12 Variable Frequency Drives
- 6.6.13 Emergency Electrical Power
- 6.6.14 Equipment, Ductwork, and Piping Identification
- 6.6.15 Biosecurity
- 6.6.16 Seismic Accommodation
- 6.6.17 HVAC Plans
- 6.6.18 Inspection, Testing, Validation, and Certification

## 6.6.0 Introduction

The HVAC system plays an important role in control of airborne contaminants in biocontainment facilities. The ventilation system is central to biocontainment facilities' performance and operation. This section includes additional requirements to be included in biosafety level 3 (BSL-3) and animal biosafety level 3 (ABSL-3) facilities. Design of BSL-3 and ABSL-3 laboratories shall be reviewed and approved by the DTR and DOHS.

This section is not all-inclusive of *DRM* requirements and is to be used along with other sections of the *DRM* and the requirements of the risk assessment.

## 6.6.1 Design Requirements

**A. Facility Definition:** The term “BSL-3” or “ABSL-3” as used within the scope of this section, refers to laboratory and animal research facilities performing work at biosafety level 3 as defined in the HHS/CDC/NIH *Biosafety for Microbiological and Biomedical Laboratories (BMBL)* including facilities where work may include select agents. BSL-3 and ABSL-3 work may include manipulations with high-risk organisms within primary containment. Where work includes agricultural agents or select agents or pathogens of veterinary significance, additional enhancements in accordance with U.S. Department of Agriculture Animal and Plant Health Inspection Service/Agricultural Research Service (APHIS/ARS) standards may be required based on a site-specific risk analysis, including the housing/primary barrier configuration.

**B. Special Applications:** Special applications including but not limited to Good Large-Scale Practice (GLSP), recombinant DNA (as defined in the NIH Guidelines for Research Involving Recombinant or Synthetic Nucleic Acid Molecules, and work with special vectors (such as arthropods) or certain select agents and pathogens of veterinary significance which may be subject to additional requirements that are to be addressed on a project-specific basis. Conduct a pre-planning/pre-design review meeting with the DTR and DOHS.

**C. Ventilation System:** The ventilation system for BSL-3 and ABSL-3 facilities under normal operating systems shall maintain directional air movement from areas

less contaminated to areas that are progressively more contaminated inside the lab. The system shall also be designed so there is no reverse airflow of potentially contaminated air from inside to outside the containment zone during failures and recovery of failures of the ventilation system.

*Rationale: This is a fundamental requirement to protect the occupants and the environment outside the containment zone.*

**D. Redundancy Requirements:** BSL-3/ABSL-3 facilities shall be provided with N+1 redundancy for air handlers, exhaust fans, HEPA filters, pumps, chillers and boilers.

*Rationale: Redundancy of these elements allows for the maintenance of directional airflow and to allow safe continuation or shutdown of procedures in the event of loss of a primary HVAC system.*

**E. Equipment Performance:** All primary containment equipment, BSCs, glove boxes, aerosolization chambers, ventilated cage racks, downdraft tables, etc., should perform as prescribed in conjunction with the HVAC system. Negative pressure shall be maintained at all times, including when equipment is out of service or during equipment failure. Conflict between the primary containment equipment and the building's HVAC system must be avoided.

**F. Containment Equipment Placement:** Primary containment equipment such as BSCs and individual ventilated caging (IVC) shall be placed in the room so that containment is not impacted by supply diffusers or exhaust grilles or doors or traffic flow.

**G. Ductwork and Piping:** To the extent possible, ductwork and piping should be concealed. Where exposed ductwork and piping is required, surfaces shall be cleanable, compatible with fumigation, and free of sharps and hazards.

**H. Penetrations:** All penetrations shall be tested to meet the room-tightness criteria for BSL-3 laboratories.

**I. Sealant:** Penetrations shall be sealed with an approved non-shrink corrosion-resistant gastight

permanent sealant. Spray foam is not acceptable. Refer to [Appendix L: Sealant Table](#).

**J. Insulation:** Insulation shall terminate at the back face of the penetrated material prior to the containment barrier, unless rigid, easily cleanable, non-porous, and chemically compatible preapproved insulation systems are utilized.

*Rationale: Conventional piping system insulation does not meet stringent DRM requirements. Continuous insulation through barrier penetrations requires use of rigid insulation systems (such as pre-insulated piping systems utilizing solid plastic or metal encasement) to achieve a satisfactory durable seal.*

**K. Ductwork Leak Testing:** Ductwork on the exhaust side between containment zone/HEPA filter and the supply side between isolation damper and the room outlet shall be tested in accordance with ASME N510, Testing of Nuclear Air Treatment Acceptance criteria leakage rate of not greater than 0.1% of volume at 1,000 Pa (4 in. w.g.).

## 6.6.2 Supply Air Systems

**A. Dedicated Supply Air Systems:** BSL-3 laboratory and ABSL-3 spaces shall be provided with dedicated supply air systems, which do not serve any other laboratory spaces outside the containment laboratory. Refer to [Chapter 7: Building Automation Systems](#) for detailed control requirements and pressure control requirements.

**B. Supply Ductwork materials:** All supply ductwork downstream of the isolation damper shall be constructed of welded stainless steel to provide the duct leak tightness. Minimum gauge of stainless steel duct shall be 18G.

**C. Independent Supply Air Terminal:** To the extent possible, each room shall be served by an independent supply air terminal to maintain pressure differential within each room. Supply terminals shall be lab quality industrial grade. Terminals can be pressure-independent venturi type or ultra low leakage damper style shut-off boxes.

## 6.6.3 Ventilation Rates in BSL-3 Laboratories

BSL-3 laboratories shall be provided with a minimum of 6 air changes per hour (ACH). This minimum air flow shall be maintained at all times, including unoccupied periods. Air ventilation system shall be designed to remove all heat dissipated by all equipment within the lab space and all exhaust air requirements from fume hoods, BSCs, sterilizers, etc.

## 6.6.4 Ventilation Rates in ABSL-3 Laboratories

Ventilation rates in animal facilities are typically 10 to 15 outdoor ACH. Refer to [Section 6.1 Heating, Ventilation, and Air Conditioning Design](#) for additional requirements. Ventilation rates shall be reviewed and approved by the DTR and DOHS.

*Rationale: BSL-3 and ABSL-3 ventilation rates have been established to provide for the safe and effective removal of potential airborne contaminants from the laboratory air space, and for odor control and removal of animal dander.*

## 6.6.5 Relative Room Pressurization

Airflow in BSL-3 and ABSL-3 biocontainment facilities shall be designed based on a risk assessment to move from areas designated as less biohazardous to areas with a greater biohazard risk. The system shall be designed to maintain a negative pressure differential of 12.5 Pa (0.05 in. w.g.) between each pressure zone. Where multiple containment zones exist within the suite, sequentially more negative pressure must be established so that more contaminated rooms are placed at negative pressure to less contaminated rooms. Monitoring and control devices shall be provided to ensure that the pressure differential is maintained. Visual readout devices, such as magnehelic gauges or digital display monitors, and alarm devices shall be provided at the entry to the

containment space, in anterooms, and at entry to the individual rooms within the containment suite.

***Rationale:** An area that is less biohazardous is not necessarily clean. Materials being manipulated may be classified differentially but be just as hazardous. Minimum differential pressure creates an inward flow of air from outside of containment to inside of containment. Visual and alarm devices are designed to notify users of any loss in pressure and/or loss of containment.*

### 6.6.6 Anterooms

Anterooms shall be located between the BSL-3/ABSL-3 and the clean corridor outside the biocontainment space. These anterooms are typically negative to the clean corridor and positive to the BSL-3/ABSL-3 spaces keeping airborne contaminants in the biocontainment room.

***Rationale:** Anterooms provide a buffer between the clean corridor and the biocontainment room.*

### 6.6.7 Exhaust Air Systems

**A. Dedicated Exhaust Air Systems:** BSL-3 and ABSL-3 spaces shall be provided with dedicated exhaust air systems. BSL-3 and ABSL-3 may not be combined to a common system or any other system serving spaces outside the biocontainment space. This dedicated exhaust air system shall include pressure-independent constant-volume air terminal units, roof-mounted exhaust fans (number of fans to provide  $N + 1$  redundancy), VFD for filter loading and/or for multiple rooms applications, exhaust stacks, etc.

***Rationale:** Dedicated systems provide protection against cross-contamination to spaces outside of containment.*

**B. Exhaust Ductwork Materials:** All exhaust ductwork shall be welded stainless steel and gastight to allow for decontamination. Stainless steel shall be of a minimum 18 gauge.

**C. Independent Exhaust Air Terminal:** To the extent possible, each room shall be served by its independent exhaust air terminal. Exhaust terminals shall be lab quality industrial grade. They can be pressure-independent venturi type or ultra low leakage damper style shut-off boxes. All internal exposed areas of the exhaust terminals shall be stainless steel or epoxy coated to handle the vaporized decontaminated gases.

***Rationale:** Independent exhaust air terminals maintain pressure differential within each room.*

### 6.6.8 Air Filtration

**A. Supply Air:** Supply air serving BSL-3 laboratories and ABSL-3 animal facilities is not required to be HEPA filtered, unless specifically required per the program. If HEPA filtration is requested on supply air, it shall be reviewed by the DTR and the DOHS.

**B. Exhaust Air HEPA Filtration:** Exhaust air HEPA filtration is recommended and each particular system/application shall be reviewed with the user, the DTR, and the DOHS. If HEPA filtration is not required, the exhaust air system shall be designed with provisions for adding HEPA filtration in the future.

***Rationale:** Exhaust air HEPA filtration is recommended to eliminate the possibility of re-entrainment of BSL-3 or ABSL-3 exhaust air into the intake air and to filter highly infectious agents and pathogens that may cause risk to the environment.*

**C. HEPA Filter Location:** HEPA filters shall be located as close as possible to the containment barrier penetration. HEPA filters shall be rated for 99.99% efficiency at 0.3 microns. These filters shall include provisions for bag-in/bag-out filter replacement. HEPA filters shall be located with consideration to replacement and testing



procedures. HEPA filters shall be zoned so that shut downs can be coordinated. Provide redundant filter banks to allow replacement of filters during operation.

***Rationale:** Placement of HEPA filters close to the containment barrier penetration minimizes the amount of contaminated exhaust ductwork that is located outside of containment.*

**D. HEPA Filter Housings/Dampers:** The HEPA filter housings shall be welded stainless steel construction. Each HEPA filter shall be capable of in situ decontamination and full face scanning. Bubble-tight dampers shall be used for HEPA filter isolation. Bubble-tight dampers shall be of the positive seal type with zero leakage and rated for the pressure classification of the system. HEPA housings shall include sampling and injection ports to allow for appropriate leak testing. A separate inlet test section is recommended. Both magnehelic differential pressure gauges and BAS monitoring shall be provided for handling filter pressure drop. The housing shall be accessible and space provided for filter change-outs. Housings located on the roof shall have a protected cover over the unit to protect against weather.

**E. Specialized Equipment:** Equipment that generates aerosols, such as continuous flow centrifuges, shall be protected with HEPA filters before discharging the air into the room.

## 6.6.9 Isolation Dampers

**A. Design:** Bubble-tight isolation dampers isolate ducts or rooms from adjacent spaces. Gases that are used for decontamination such as formaldehyde, vaporized hydrogen peroxide (VHP) or chlorine dioxide, must be contained in the intended zones so as not to affect adjacent areas. The bubble-tight dampers shall be selected based on tightness of the body, leak performance, frequency of closure, static pressure, noise, maintenance requirements and speed of response on actuation. Isolation dampers shall be automatically activated to prevent positive pressurization of containment spaces. Typically, airflow control valves do not meet the required performance of the bubble-tight dampers and are not recommended to be used as isolation dampers.

**B. Isolation Damper Locations:** Bubble-tight isolation dampers shall be provided between the room supply air terminal, the room supply air diffuser, and between the room exhaust grille and room exhaust air terminal.

***Rationale:** These locations for isolation dampers allow isolation of the room and subsequent decontamination after an accidental spill or the release of a BSL-3 or ABSL-3 agent.*

**C. Access to Dampers:** Access to the bubble-tight dampers shall be from outside the laboratory suite.

## 6.6.10 Autoclaves

**A. Exhaust Canopy Hoods:** Autoclaves serving BSL-3 and ABSL-3 shall be provided with stainless steel exhaust canopy hoods over the door to capture steam and aerosols from the autoclave. In the case of double-sided or pass-through autoclaves, stainless steel canopy hoods shall be provided over both the “dirty” (loading) side and the “clean” (exit) side door. The dirty-side canopy exhaust will be tied into the containment exhaust while the clean-side exhaust may be tied into the non-containment exhaust.

***Rationale:** Canopy hoods allow the capture of steam and aerosolized contaminants during opening of the autoclave doors.*

**B. Autoclave Service:** Steam isolation valves, steam traps, and chilled water isolation valves shall be located outside the containment barrier. To the extent possible, service to the autoclave shall be performed from outside the containment. Autoclave service area shall be conditioned to maintain a maximum of 32°C (90°F) to keep the electronics and controls from over heating.

***Rationale:** These requirements are intended to enhance safety, reliability, ease of maintenance, serviceability, and longevity of the affected equipment and systems.*



### 6.6.11 Service Access Panels and Mechanical Spaces

Access panels through the containment barrier walls or ceilings shall be avoided. To the extent possible, piping, valves, dampers, and air terminals shall be located outside the containment barrier. Alternatively, the use of full stainless steel access cabinets with closed back and sides, gaskets, and stainless steel pipe inserts weld-sealed to the box can be utilized to provide a sealed box arrangement.

Major equipment serving the containment spaces shall be located in interstitial spaces or mechanical galleries or corridor.

*Rationale: Access doors and panels are a common source of leakage and even where gasketed, such devices are known to leak over time. Closed box arrangements can serve as an extension of the barrier and perform effectively. Separation of mechanical service equipment from containment areas allows proper function of the systems and allows for safe operability, maintenance, and reduces exposure of staff to biohazardous materials.*

### 6.6.12 Variable Frequency Drives

Following a power outage and the initiating of the emergency electrical power, all VFDs associated with supply and exhaust fans serving BSL-3 or ABSL-3 spaces, which are required to maintain biocontainment, shall be provided with the ability to restart into a coasting motor without delays and without damaging the motor. The drive shall be able to catch the motor on the fly. The drive shall be able to identify motor rotation and when the opposite rotation is detected, slow the motor down to zero speed, otherwise, smoothly accelerate the motor to the commanded speed with the correct direction without tripping on an overvoltage or overcurrent condition. Mechanical brakes or anti-ratcheting devices can be used to ensure that a fan does not rotate in the wrong direction.

### 6.6.13 Emergency Electrical Power

Supply air fans, exhaust air fans, control and BAS, and all devices and equipment serving and/or associated with BSL-3 and ABSL-3, which are required to maintain biocontainment of the space shall be connected to an emergency electrical power system. Emergency loads shall be able to supply standby power in 10 seconds or less.

### 6.6.14 Equipment, Ductwork, and Piping Identification

Equipment, ductwork, and piping systems shall be accurately identified and services specific to containment spaces shall clearly designate the specific function. Identification shall include the universal biohazard sign at ductwork, piping, and at equipment.

*Rationale: Adequate and specific identification of ductwork and piping systems is critical to avoid inadvertent cross-connections, service disruptions, and to provide identification for maintenance procedures.*

### 6.6.15 Biosecurity

Systems and equipment shall be located only in secured areas compliant with facility biosecurity requirements and the risk assessment. Suitable containment support spaces should be coordinated with the risk assessment. For specific security requirements, coordinate with DPSM through PO. See [Section 1.13](#).

### 6.6.16 Seismic Accommodation

In areas of seismic activity, accommodation shall be provided to preclude shearing of piping, ductwork, or critical equipment damage due to differential movements.

Fixed equipment shall be properly anchored to structure. Such analysis and accommodation shall be performed by qualified structural and mechanical engineers in coordination with the NIH and the DOHS.

### 6.6.17 HVAC Plans

All design phases of the construction documents shall be reviewed and approved by the DTR and the DOHS. Documents shall include room pressurization diagrams, leakage/pressure calculations, and location of exhaust equipment, air balance drawings, control drawings, sequences of operation including failure sequences, and commissioning and testing documentation.

### 6.6.18 Inspection, Testing, Validation, and Certification

Conformance with the requirements of this chapter shall be confirmed in the installation of HVAC systems serving BSL-3 and ABSL-3 containment. Systems shall be inspected throughout installation to ensure conformance with the requirements of the DRM. In addition, the following specific issues shall be addressed, inspected and reviewed as part of quality control, testing, and commissioning plans. The following items shall be reviewed and inspected within the HVAC discipline. The list is not intended to identify commissioning requirements or to be all inclusive.

1. Ensure all required standby power has been provided and proper response to integrated systems testing.
2. The testing of ventilation system and controls shall follow the American National Standard Institute (ANSI) Standard Z9.14 Testing and Performance Verification Methodologies for Ventilation Systems for Biosafety Level 3 (BSL-3) and Animal Biosafety Level 3 (ABSL-3) Facilities. These include supply and exhaust air systems, directional air flow, biological safety cabinet, air filtration, exhaust stacks, fan failure scenarios, canopy hoods and specific ABSL-3 requirements.
3. Refer to *DRM Chapter 7: Building Automation Systems* for information on BAS, controls, and failure testing scenarios for HVAC systems serving BSL-3 and ABSL-3 facilities.
4. NIH requires a thirty day endurance period after beneficial occupancy for BSL-3 and ABSL-3 facilities.

**Rationale:** *Once beneficial occupancy is received, laboratory moveable equipment (freezers, refrigerators, incubators, large centrifuges etc.) are moved into the facility. Laboratory drills, SOPs training, etc. is developed. During this period the mechanical and electrical systems should run without interruption.*

# Chapter 7

---

## Building Automation Systems

# Section 7.1

## Design Considerations

---

### Contents

- 7.1.0 Introduction
- 7.1.1 General Requirements
- 7.1.2 BAS Overview
- 7.1.3 BAS Growth
- 7.1.4 Renovation and Rehabilitation
- 7.1.5 Codes, Standards and References
- 7.1.6 Standardization
- 7.1.7 Access Requirements
- 7.1.8 Point-Naming Conventions
- 7.1.9 Design Planning and Coordination
- 7.1.10 Design Document Submittal
  - 7.1.10.1 Control System Design
  - 7.1.10.2 Design Specifications and Drawings
  - 7.1.10.3 Design Control Schematics
    - 7.1.10.3.1 Design Points List
    - 7.1.10.3.2 Detailed Written Sequence of Operations
    - 7.1.10.3.3 BAS Infrastructure Diagrams
    - 7.1.10.3.4 Valve Schedule
- 7.1.11 Shop Drawings and Record Document Submittals
  - 7.1.11.1 Control System Architecture
  - 7.1.11.2 Control Schematics
  - 7.1.11.3 Control Sequence of Operations
  - 7.1.11.4 Product Data
  - 7.1.11.5 Detailed Wiring Diagrams
  - 7.1.11.6 Valve Schedules
  - 7.1.11.7 Points List
  - 7.1.11.8 Zone Airflow Control Schedules
  - 7.1.11.9 Floor Plans
  - 7.1.11.10 Sample Graphics
  - 7.1.11.11 Response-Time Requirements
  - 7.1.11.12 Operation and Maintenance Manuals
  - 7.1.11.13 Damper Schedule
- 7.1.12 Documentation Format
  - 7.1.12.1 Hard Copy
  - 7.1.12.2 Electronic Copy

## 7.1.0 Introduction

This section describes the general building automation systems (BAS) design considerations, as well as the specific requirements for control sequence design and construction document submittals.

### 7.1.1 General Requirements

**A. BAS Objectives:** The following design requirements apply to all BAS. The intent is to provide uniformity of design, combine the best overall economy with suitability of design, and be compatible with all other building systems. NIH shall make provisions for future expansion and specific project/program-related requirements on a project-by-project basis.

**B. Network Configuration:** The BAS is configured as a network with control functions at multiple levels and with multiple points of operator control and supervision. The BAS includes central servers, local building engineers' workstations, data-transmission systems, field panels and controllers, and necessary interfacing controls, sensors, and actuators. The controller contains a microprocessor and other supporting electronics, performs local control functions and executes application programs without requiring communications with the central server or workstations. All new facilities and renovations shall use digital controls in accordance with the DRM. For small renovation projects, matching existing controls may be considered using the variance process. The A/E and the project officer (PO) shall meet with maintenance staff early in the project to coordinate new digital controls with existing systems.

### 7.1.2 BAS Overview

**A. Digital Control Systems:** The NIH requires fully automated, reliable, but cost-effective direct digital control systems for all building systems. The A/E shall:

1. Establish a level of quality for the control systems installed at the NIH
2. Promote and facilitate consistency among the numerous projects

3. Establish the extent of the control system that is required and cost-effective for the NIH, synthesizing the requirements of the design, management, and operations of the facility
4. Establish preferences relative to the BAS

*Exceptions: The DRM applies to BAS that control and/or monitor all systems in the building. The following are exceptions:*

1. *Central or stand-alone chilled water plants involving chillers and cooling towers, etc. The DRM covers building-level connections to a campus system or other chilled water plants.*
2. *Central or stand-alone hot water or steam plants including boilers. The DRM covers building-level connections to campus steam or hot water generating systems.*
3. *Scientific equipment monitoring systems*
4. *Laboratory information monitoring systems*
5. *Fire alarm systems and the communication between fire alarm system and the BAS*
6. *Elevators*
7. *Security*

*Rationale: Each institute is generally responsible for the operation and maintenance of its scientific equipment.*

### 7.1.3 BAS Growth

**A. Ample Capacity:** BAS requirements will change during the life cycle of a NIH facility that will undergo many alterations. Therefore, BAS must have ample capacity to meet future increased control demand and allow for modification in one area without disrupting another area of a facility.

**B. Growth Provisions:** BAS design shall include provisions for future system growth as determined by the NIH on a project-by-project basis.

## 7.1.4 Renovation and Rehabilitation

**A. BAS Capability in an Existing Facility:** Renovation and rehabilitation of existing facilities do not always allow for the adoption of the latest BAS industry standards. Sometimes, the existing BAS is antiquated or inadequate for the current need, or the newly planned function may be incompatible with the original building design criteria.

**B. Evaluating Use of Latest Standards:** The A/E shall evaluate early in the design stage the feasibility to implement the latest BAS standards. The A/E shall document the findings and submit recommendations to the PO. If a variance is required, see [Appendix K: DRM Variance Form](#).

## 7.1.5 Codes, Standards and References

The A/E shall comply, at a minimum, with the latest edition of the applicable codes and standards as listed in in this chapter as well as within [Chapter 1: Administration](#). In addition, the A/E shall comply with other safety guidelines received from the PO and other relevant guidelines as required by the program. The A/E shall refer to [Chapter 6](#) for additional BAS requirements.

## 7.1.6 Standardization

The A/E shall strive for standardization of BAS installation across buildings, institutes and operating organizations to maintain consistency and thereby increase reliability. It is the responsibility of the institute and/or operating organization to define and present those standards to the design and construction community. The *DRM* presents concepts for standardization that must be further defined based on the organizations requirements and the latest technology that is compatible with the existing facility systems.

## 7.1.7 Access Requirements

The BAS shall have the capability of granular assignment of rights to individual methods, areas, systems, information, etc. Individual users shall be given one account name and password; regardless of where they connect into the BAS, they will be granted access to only those functions they are authorized to use.

## 7.1.8 Point-Naming Conventions

All systems shall incorporate the point-naming convention specific to the institution where the work is being done. Coordinate with the operating organization and get approval on a point-naming convention if it is not already established. Point names shall be specific. Abbreviation of parts of the point name shall be delimited with a period. Campus, Building, System, and Point are typical elements of a point name, e.g., East.Bldg01.AHU4.SA\_Temp.

## 7.1.9 Design Planning and Coordination

**A. Telecommunications:** The A/E shall coordinate through the PO with the client institutes/operating organization and applicable safety organizations for required control parameters and condition tolerances of a building system telecommunication hub and required building support hardware system for Intranet/Internet connectivity.

**B. Control/IT Contractor:** The A/E shall develop a clear scope of work (including interface point of connectivity) for the control/information technology (IT) contractor as part of their design.

**C. IP Addresses:** Requirements for Internet protocol (IP) addresses shall be established and secured through the PO.

**D. Additional Requirements:** The design shall also include:



1. Point-naming conventions
  2. Equipment-numbering conventions
  3. Graphic formats and layouts
  4. Location of operator interfaces and required number of portable operator workstations
  5. Training requirements, etc.
  6. Required user accounts and levels of access
  7. Routing of alarms and notifications
  8. Compatibility issues between new and existing systems, and level of integration between existing and new systems
3. List of all points with summary counts. All physical I/O points shall be indicated in the documents diagrammatically or as tabular format.
  4. Detailed written sequences of operation that are closely coordinated with the control system I/O points
  5. BAS infrastructure schematics
  6. Valve schedules (provided by the controls contractor)
  7. Indicate control elements on the applicable discipline design floor plans (this refers to panel locations, operator interface locations, thermostats, temperature and humidity sensors whether in the room or in the return/exhaust duct, room differential-pressure monitors, duct static-pressure sensors, motor-operated dampers, automated valves, etc.).

---

## 7.1.10 Design Document Submittal

Because of the unique nature of BAS construction, the A/E should work closely with controls contractors and vendors to produce the design document at the design phase. Contractors shall produce site- and system-specific shop drawings and record documents during the construction phase. This section details the requirements at the design submittal phase. The requirements for the shop drawings and record documents submittal are addressed in [7.1.11 Shop Drawings and Record Document Submittals](#). Some of the requirements overlap with each other.

### 7.1.10.1 Control System Design

**A. Qualified Personnel:** Projects that involve a BAS shall include a detailed control system design. Properly qualified personnel knowledgeable in the applicable control systems shall perform the design.

**B. Documentation:** At a minimum, the design documents shall include:

1. Specifications detailing the BAS requirements
2. Schematic drawings indicating the systems/zones and all control system input and output (I/O) and an indication on these points if they are digital or analog data points

### 7.1.10.2 Design Specifications and Drawings

**A. Inclusions:** Specifications and drawings shall:

1. Detail the minimum quality of all hardware commensurate with the *DRM*.
2. Define the control system documentation required commensurate with the *DRM*.
3. Define the level of controller allowed for each specific control application on the project along with the stand-alone functionality required.
4. Specify all wiring and tubing requirements.

**B. System Responsibilities:** Clearly delineate limits of responsibility and/or dictate various requirements in the specific context of the systems commensurate with the *DRM* and coordinated between disciplines. For example:

1. The scope of laboratory control systems versus commercial control systems shall be clearly identified.
2. Responsibility for mounting of terminal controllers shall be indicated.

3. Responsibilities for furnishing, installing, calibrating, and commissioning valves and dampers, standard and laboratory-grade variable air volume (VAV) terminals, sash sensors and hood monitors, general field devices, etc., shall be defined.
4. Coordinate and define responsibilities for balancing/calibrating various BAS sensors (testing and balancing [TAB] versus control contractor) with the TAB specifications.
5. Coordinate the limits of work and for connection of the BAS to the existing supervisory network.

***Rationale:** Coordination between disciplines and contractors must be established so that the entirety of a project's scope of work is covered.*

**C. Graphic Interfaces:** Specify quality and quantity of graphic interfaces to be developed for the project.

**D. Security Permissions:** Detail the security permissions to be established for the project. This requires consultation with maintenance staff and the Office of Research Facilities (ORF) facilities network services CIT/ITB team.

**E. Trending Capabilities:** Detail both the trending capabilities required of the BAS as well as the project specific requirements for setting up trends and archiving data.

**F. Warranty Period/Maintenance Requirements:** Define the warranty period and maintenance requirements. See [Chapter 1](#) for additional warranty information.

**G. Training:** Define the training required. Training requirements shall be applicable to the project and coordinated with maintenance staff.

**H. Testing Protocols:** Reference applicable NIH testing protocols such as fume hood testing.

**I. Minimal Disruption:** Detail sequence of work for renovations in existing facilities to minimize disruption.

**J. Alarm Notification:** Define emergency notification and alarming requirements. Alarm thresholds shall be dictated by applicable values and level/means of alarm notification shall be specified.

**K. Graphic-user-interface Software:** Define graphic-user-interface (GUI) software functional requirements.

**L. Digital-Control Software:** Define direct digital-control software functional requirements.

**M. AAALAC Requirements:** Detail the Association for Assessment and Accreditation of Laboratory Animal Care (AAALAC) required monitoring and documentation requirements of the systems controlling an animal facility.

**N. System Interfaces:** Detail and coordinate interfaces to other systems such as lighting-control systems, energy systems, and power-monitoring systems.

**O. Point-Naming Convention:** Define a point-naming convention. Refer to [Section 7.1.8](#).

**P. Record Documentation:** Define the record documentation requirements. Refer to [7.1.10.1 Control System Design](#).

**Q. Network Point of Connection:** Define the point of connection to the existing network.

**R. Bandwidth Calculations/Analysis:** The controls contractor is required to submit bandwidth calculations and analysis to validate either the response time for deterministic networks or percent utilization for carrier sense multiple access with collision detection (CSMA/CD) networks under a fully loaded condition with specified trending.

**S. Units Nomenclature:** Coordinate with the operations and maintenance staff for required nomenclature on terminal units.

**T. Airflow-Tracking Boxes:** Where air-flow-tracking boxes serve a room or where multiple heating, ventilation, and air conditioning (HVAC) elements control the same zone, clearly indicate the pairing relationships in a table or by nomenclature. It is not acceptable to require the controls contractor to interpret the ductwork or piping drawings to assess pairings.

**U. Stand-alone Capability Requirements:** Clearly outline the requirements for stand-alone capability, including redundancy of critical control components, of controllers controlling multiple tracking boxes in containment and biosafety level 3 (BSL-3) suites, isolation suites and animal facilities, including emergency power

requirements to maintain full-control functions in the event of a main power outage.

**V. Control Panels:** Where the operation of two or more pieces of equipment must be coordinated, e.g., supply and exhaust fans in a BSL-3 lab, they should be controlled from the same panel. If this is not possible, hard-wired interlocks may be necessary. Communication between panels across the network is not always fast enough to provide adequate results.

**W. Standalone Controllers:** Clearly outline the requirements for the stand-alone capability for controllers as well as the method for coordinating several stand-alone controllers controlling a common function across controllers. For instance, the method for controlling the static airflow/static pressure of separate air handlers on a common header system shall be specifically detailed.

**X. Concurrent Access Client Software Licensing Requirements:** The A/E shall consider the construction and commissioning requirements that may require a higher quantity of concurrent sessions to the client/server software. Show on the drawings limits of stand-alone control requirements of containment and high containment suites as defined below.

**Y. Commissioning:** Provide commissioning requirements, including all associated activities and responsibilities.

### 7.1.10.3 Design Control Schematics

**A. Control Schematic:** Control schematics shall be used to graphically indicate the systems, show the schematic configuration of the systems and location of control devices, define the point names and addresses, and define the set points for control elements.

**B. Design Requirements:** At a minimum, the control schematics at the design stage shall include the following:

1. Point names (provided by the controls contractor)
2. Point type
3. Normal position of output devices
4. Device ranges
5. Initial design intent set points (to be modified as refined during construction for record submittals)

6. Bill of materials listing all devices (provided by the controls contractor)
7. Device symbols' definitions
8. Basic motor starter and interface wiring schematics

**C. Control Parameters:** The locations of flow meters shall be shown on the piping or duct drawings. Remote static-pressure sensors for capacity control of air and water systems shall also be shown on the design drawings. The A/E shall coordinate with the PO to establish the appropriate level of control parameters for each project during the early stages of the project.

#### 7.1.10.3.1 Design Points List

The A/E shall provide a listing of all physical I/O with relation to the system and controller listed. At a minimum, the points list shall include:

1. Point type (analog input [AI], binary input [BI], digital input [DI], analog output [AO], binary output [BO], digital output [DO], etc.)
2. Point quantity with summaries by point type, summed by controller and system
3. Listing for each point and associated alarms. The alarm parameters shall be the state the point is in to cause a particular alarm including whether the source system is also enabled.

#### 7.1.10.3.2 Detailed Written Sequence of Operations

The A/E shall provide a detailed written sequence of operation. This sequence shall provide at a minimum:

**A. Sequences in all modes of operation:** These shall include on, off, occupied, unoccupied, warm-up, cool down, summer, winter, economizer, emergency loss of power shutdown and startup, etc. Detailed steps during mode switches shall be provided.

**B. Details of operation during and after a power outage:** Prioritized restart sequences shall be specified by the A/E. Loss of status associated with power outages shall not be indicated as failures with a subsequent alarm.

**C. Failure Scenarios:** Provide specific direction on failure scenarios for loss of proof and all safety device trips.

**D. Set points, trip points, and ranges:** Initially, these shall be the A/E's intent. Ultimately, these shall be the actual setting at time of record submittal.

**E. Response and Tolerance:** Detail the requirements for loop response and tolerances for control.

***Rationale:** A detailed sequence of operations (including failure mode procedures) is important for the commissioning process as well as the operation, maintenance, and troubleshooting.*

#### 7.1.10.3.3 **BAS Infrastructure Diagrams**

The A/E shall include in the contract documents a diagram that depicts the intended architecture of the BAS infrastructure. Diagrams shall show all control and supervisory Local Area Network's (LANs), GUIs, alarm enunciators and printers, routers, gateways, controllers (terminal controllers can be grouped), etc. Each LAN shall be indicated with intended media and protocols. Location of GUIs shall be identified. Point of interface for institute-supplied LAN media shall be depicted. Also, depict point of connection for interfaces.

#### 7.1.10.3.4 **Valve Schedule**

Both A/E and the controls contractor shall select and schedule valves. Selection shall be made to facilitate smooth and stable control. Either with the control schematic or separately in contract documents, shop drawing submittal and record submittal shall provide a valve schedule listing the following:

1. Size
2. Valve type
3. Actuator type
4. Flow coefficient (Cv)
5. Design flow
6. Design pressure drop
7. Close-off rating
8. Normal positions

9. Valve characteristics (i.e., equal percentage, linear)
10. Manufacturer (basis of design [BOD])
11. Model number (BOD)
12. Valve turndown

## 7.1.11 **Shop Drawings and Record Document Submittals**

**A. Shop Drawing Definition:** Shop drawings are a set of drawings produced by the controls contractor or vendor for the installation and coordination between mechanical/electrical/plumbing (MEP) trades during the construction phase.

**B. Record Documentation:** Record documentation as indicated herein shall be maintained and submitted to reflect the final installed condition of the BAS. The record documents shall be kept up to date throughout the construction period and submitted as final at final acceptance.

### 7.1.11.1 **Control System Architecture**

**A. System Architecture One-Line Diagram:** A system architecture one-line diagram indicating schematic location of all control units, workstations, LAN interface devices, gateways, etc., shall be provided.

1. Indicate address and type for each control unit.
2. Indicate physical media, protocol, and type of each LAN.

**B. Control-System Architecture Speed:** The control vendor shall submit at the submittal stage, calculations estimating the speed of response for the reactions as dictated in [Section 7.2 Infrastructure](#) along with the control system architecture diagram. These calculations shall be made to the point at which the architecture is completely under the control of the contractor, which will not include the campus wide area network (WAN). The assumption shall be made that the operator workstation is connected to the primary controller LAN.

### 7.1.11.2 Control Schematics

Control schematics are required both as part of the contract documents (generated by the A/E), shop drawing submittals, and record document submittals. At a minimum, the following shall be included in the control schematics:

1. Point names (using convention dictated herein)
2. Point addresses (not applicable to the contract documents)
3. Point type
4. Normal position of output devices
5. Device ranges
6. Initial design intent set points modified as refined during construction for record submittals
7. Bill of materials listing all devices and manufacturer numbers (not applicable to the contract documents)
8. Device symbols' definitions

### 7.1.11.3 Control Sequence of Operations

All projects shall include a detailed sequence of operations. Sequences may be on the control schematics or in the specifications in the contract documents, and shall be included with the control schematics for the shop drawing and record submittal. Control sequences shall be highly detailed in the design phase and shall maintain this detail throughout the record submittal phase. The same requirements for the design document (7.1.10.3.2 Detailed Written Sequence of Operations) apply for shop drawings and record drawings.

### 7.1.11.4 Product Data

**A. Manufacturer's Technical Product Data:** Submit manufacturer's technical product data for each control device, panel, controller, and accessory furnished, indicating dimensions, capacities, performance and electrical characteristics, and material finishes.

**B. Installation/Startup Instructions:** All product and device installation and startup instructions shall be provided.

### 7.1.11.5 Detailed Wiring Diagrams

**A. Required Wiring Diagrams:** Shop drawings and record submittals shall include detailed wiring diagrams. Indicate all required electrical wiring.

**B. Diagram Types:** Wiring diagrams shall include both ladder-logic-type diagrams for motor starter, control, and safety circuits and detailed digital-interface panel point termination diagrams with all wire numbers and terminal block numbers identified.

1. Provide panel termination drawings on separate drawings.
2. Ladder diagrams shall appear on systems' schematics.

**C. Wiring Status:** Clearly differentiate between portions of wiring that are existing or new, and factory or field installed.

*Rationale: A clear and accurate wiring diagram is important for building operation, troubleshooting, and maintenance.*

### 7.1.11.6 Valve Schedules

Either with the control schematic or separately in a shop drawing and record submittal, provide a valve schedule listing the following including actuator information:

1. Size
2. Cv (Flow coefficient or flow capacity rating of valve)
3. Maximum flow
4. Pressure drop at maximum flow
5. Manufacturer
6. Model/product number
7. Close off rating
8. Normal positions
9. Valve characteristics
10. Design controlled circuit-pressure-differential range (coordinated with the submittals)

**7.1.11.7 Points List**

**A. Tabular Point List:** A detailed point list shall be provided in tabular form. Indicate all physical and virtual points and organize by system/subsystem.

**B. Additional Data:** At a minimum, include names, descriptors, addresses (when known), and point types with applicable range. These shall be provided electronically in either a database format or in a spreadsheet format.

**7.1.11.8 Zone Airflow Control Schedules**

**A. Airflow Schedules:** Details of all control settings shall be provided in a schedule including minimum and maximum airflow, supply air-temperature ranges, actuator types, ranges and fail positions, and terminal sizes and capacities.

**B. Pressure-Controlled Zone:** Where terminals are associated to form a pressure-controlled zone, zone-level minimum and maximum airflow shall also be indicated as well as the pairings of the boxes.

**7.1.11.9 Floor Plans**

A set of floor plans shall be provided locating and identifying all controllers, sensors, operator workstations, interface devices, etc.

**7.1.11.10 Sample Graphics**

The BAS vendor shall submit sample graphics for approval. The A/E and PO, after consultation with operating organization shall approve or disapprove the graphics.

**7.1.11.11 Response-Time Requirements**

The A/E shall include in the specifications that the contractor must submit guaranteed response times with shop drawings including calculations to support the guarantee.

***Rationale:** The communication speed between the controllers, LAN interface devices, and operator workstations shall be sufficient to ensure fast system response time under any loading condition.*

In no case shall delay times between an event, request, or command initiation and its completion be greater than the following:

1. 5 seconds between a high-priority (critical) alarm occurrence and alert at the operator workstation
2. 10 seconds between a low-priority alarm occurrence and alert at the operator workstation
3. 10 seconds between an operator command via the operator interface to change a set point and the subsequent change in the controller
4. 5 seconds between an operator command via the operator interface to start/stop a device and the subsequent command to be received at the controller.
5. 10 seconds between a change of value or state of an input and it being updated on the operator interface
6. 10 seconds between an operator selection of a graphic and it completely painting the screen and updating at least 20 points.

**7.1.11.12 Operation and Maintenance Manuals**

**A. Operation and Maintenance Manuals:** Operation and maintenance (O&M) manuals shall be provided in concert with training. Provide O&M Manuals in hard copy and text searchable (using standard Acrobat search feature) PDF electronic format.

**B. Inclusions:** O&M manuals shall include the following:

1. Maintenance instructions and spare parts list for each type of control device, control unit, and accessory
2. BAS user's guides (operating manuals) for each controller type and for all workstation hardware and software and workstation peripherals
3. BAS advanced-programming manuals for each controller type and for all workstation software



4. Record documents (product data, shop drawings, control logic documentation, hardware manuals, software manuals, installation guides or manuals, maintenance instructions, and spare parts lists)

### 7.1.11.13 Damper Schedule

The controls contractor shall provide the following information on the damper and the actuator:

1. Size
2. Damper type
3. Actuator type
4. Design flow
5. Design pressure drop
6. Damper leakage class
7. Normal positions
8. Manufacturer make
9. Actuator make
10. Actuator torque

## 7.1.12 Documentation Format

### 7.1.12.1 Hard Copy

Paper copies of the indicated deliverables as directed by the PO shall be provided. Quantities shall be enumerated in the contract documents.

### 7.1.12.2 Electronic Copy

**A. Electronic Format:** All submittal and record documents shall be provided electronically in any of the following formats:

1. Microsoft Office components
2. Adobe Acrobat portable document format (PDF)
3. HTML format
4. Format shall be as stated in [Appendix E](#)

**B. Directory:** Different components may be in different formats. However, one directory shall be provided in any of the first three formats with relative hyperlinks to all the documents.

**C. PDF + Hyperlinks:** One set of all submittals and electronic documents shall be provided in searchable portable document format. This electronic document shall be organized with either bookmarks or hyperlinks to allow navigation from an electronic table of contents directly to individual control drawings, product data, schedules, wiring diagrams, etc.

**D. AutoCAD:** Record control shop drawings shall be provided in a Format as stated in [Appendix E](#) and shall allow editing and modifications.

# Section 7.2

## Infrastructure

---

### Contents

**7.2.0 Introduction**

**7.2.1 General Requirements**

**7.2.1.1 Network Topology and Data Communication**

**7.2.2 Integration with Existing Systems**

**7.2.3 Integration with Newly Installed Systems**

**7.2.4 Controller Networks**

**7.2.4.1 General Controller Network**

**7.2.4.2 Primary Controller LAN**

**7.2.4.3 Secondary Controller LAN**

**7.2.4.4 Gateways, Switches, and Routers**

**7.2.4.5 Configuration of Control LANs**

**7.2.5 Servers**

**7.2.6 Operator Workstations**

**7.2.7 Remote Connections**

**7.2.8 Intranet Remote Connections**

## 7.2.0 Introduction

This section describes the general BAS network topology, data communication protocols, and the control network components such as the controllers, servers, and work stations.

### 7.2.1 General Requirements

**A. Integrated Digital Control System:** The BAS shall be an integrated digital control system composed of a tiered LAN architecture connecting supervisory servers/interfaces and distributed stand-alone multilevel controllers. Supervisory graphic software system configuration and backup software shall use a client/server architecture to store and serve the graphics, user databases, system configuration databases, site controller programming backup/upload/download configurations, etc.

*Exception:* Where the primary controlling LAN is a subnet or segment of the institute’s intranet, the LAN infrastructure may be provided by the institute’s data provider.

#### 7.2.1.1 Network Topology and Data Communication

**A. NIH Bethesda Campus Network:** As a simplified schematic drawing illustrated in Figure 7.2.1.2, the NIH Bethesda campus network consists of a management-level network and a building-level control network. At the Bethesda campus, NIH currently utilizes three database servers and management level networks (one for Siemens on the Bethesda main campus, one for Siemens at NIHAC Poolesville, and one for Johnson Controls and multiple switches).

**B. Building-Level Control Network:** The building-level control network consists of one or more supervisory control panels (SC panels) that communicate with the database servers. Each SC panel connects to

Figure 7.2.1.2 The NIH Bethesda Campus Building Automation System Network Layout

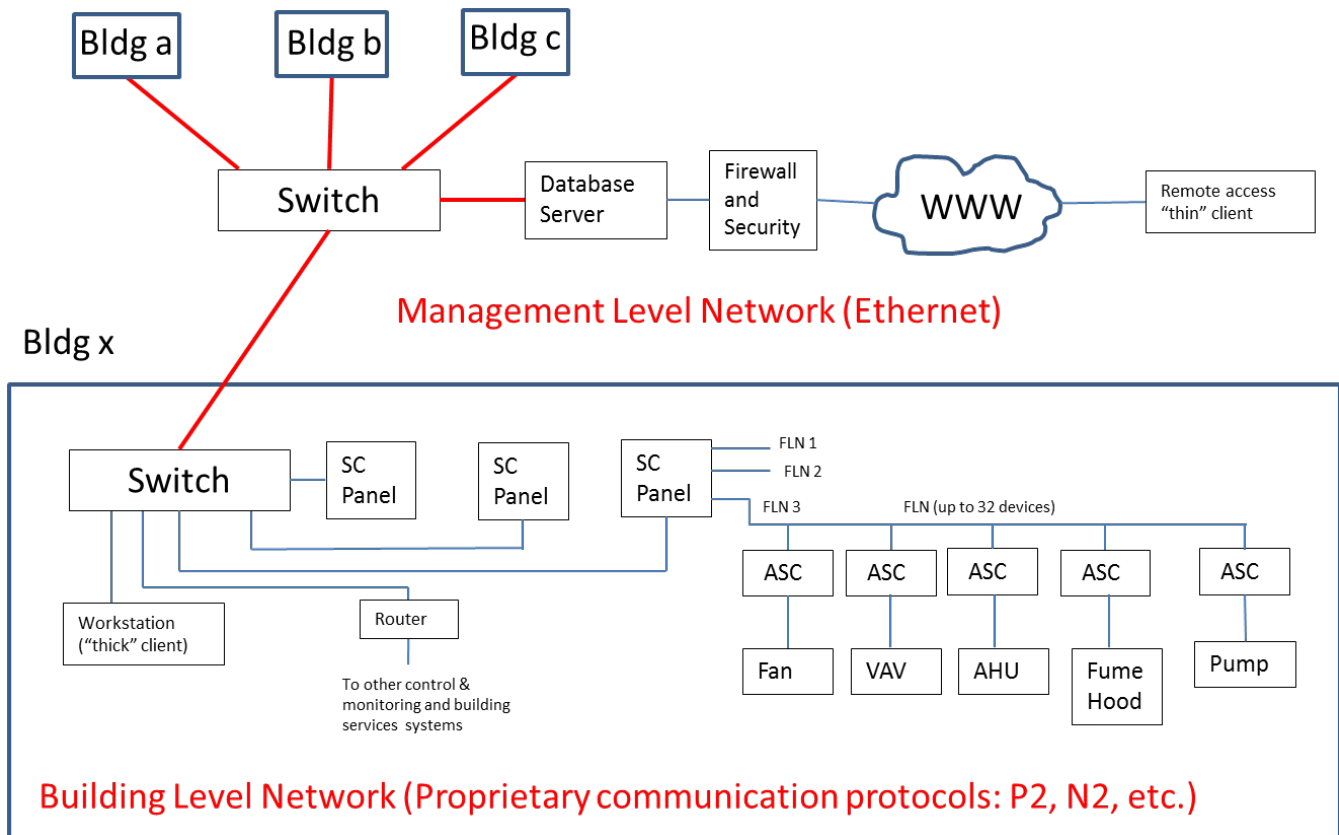

multiple application-specific controllers (ASCs), which are peripheral devices containing program and points used to control room temperature, pressurization, fan coil units, etc. Devices are daisy-chained along and only transmit data when polled and ASCs cannot initiate a communication. An ASC is self-contained and operates independently of the SC panel or the server, so it can operate on the network or as a stand-alone device. Programming and the set parameters are stored in non-volatile memory and will not be lost when power is lost and normal operation can resume as soon as power is restored.

**C. Redundancy:** Redundancy is provided by having all data stored locally at the SC panel as well as on the database servers. All data are synchronized between the remote panels and the servers so if one device suffers a power loss or other failure the data is stored elsewhere on the network.

**D. Protocols:** At the management level, the Ethernet is the communication protocol. At the building level, proprietary communication protocols (e.g., P2 for Siemens and N2 for Johnson Controls) are used after the switch or the media converter. The management-level supervisory LAN/WAN shall be provided by the applicable institute to the point dictated in the contract documents. Building field-level controlling LANs shall be provided by the contractor.

**E. Servers:** Servers act as domain controllers administering all of the communication traffic over the network. When the user commands a point from the Graphic Unit Interface of a front-end workstation, the workstation contacts the server, then the server hands the data down to the appropriate SC panel, which then commands the point. Once the point has changed state, the SC panel relays that information back to the server. Then, the server informs the workstation to change the state of the point on the graphical display.

**F. Client Workstations:** Operators can access the BAS from “thick” or “thin” client workstations. A “thick” client workstation has full access to the server and the control functions, whereas a “thin” client workstation accesses the server through an Internet browser with limited functions.

Proprietary communication protocols are P2 for Fujitsu Siemens and N2 for Johnson Controls. AHU = air handling unit; ASC = application-specific controller;

FLN = field level network; SC = supervisory control; VAV = variable air volume; WWW = worldwide web.

---

## 7.2.2 Integration with Existing Systems

Any new BAS system shall fully integrate with existing BAS installations. The PO shall facilitate a meeting between the A/E and maintenance staff early in the project to coordinate the new work with the existing digital controls. Fully integrate shall mean the following:

**A.** All physical and virtual input/output (I/O) shall be capable of being displayed on and modifiable (spawning a point-specific configuration menu from the graphic is acceptable) from a standard graphic on one of those systems.

**B.** Indicated points shall have capability to be overridden and/or put in test mode from the existing supervisory system. Digital controls’ manufacturers that do not have this capability can work around it by making the control point a virtual point referencing the physical point.

**C.** Security restrictions set on the existing system shall duly restrict access throughout the new system.

**D.** All alarm-routing functionality required herein shall be provided on the existing system when alarms occur on the new system.

**E.** Schedules on the new system shall be readable and modifiable from one of the existing GUIs.

**F.** Point-configuration databases shall be stored on one of the existing servers.

**G.** Site-specific controller programming shall be stored (backup) on one of the existing system’s servers and the controller programming shall be modifiable from the existing system and the programming stored on the server shall be uploadable/downloadable between the new field controllers and the existing servers.

**H.** Trends of points on the new system shall be able to be configured to accumulate in the buffer of the field controller and periodically uploaded to one of the existing servers for storage/archiving.

I. All points and tuning parameters on the new system shall be assessable and modifiable from any one of the existing workstations.

J. All alarms shall be displayed on all existing workstations.

K. All point databases shall be set-up to meet the existing point-naming conventions.

---

## 7.2.3 Integration with Newly Installed Systems

Multiple manufacturers may be integrated into one system; however, to keep the system simple and the parts interchangeable, the A/E is encouraged to use as few manufacturers as practical and preferably one manufacturer. When multiple control products are installed at NIH on a given project, they shall seamlessly integrate such that all information from the subordinate system shall be accessible and modifiable from the supervisory system. One supervisory system shall be provided for the entire system with full functionality. Using two independent systems to meet the requirements of the *DRM* is unacceptable. Examples of where these requirements apply and where the systems shall be integrated include:

1. The direct digital control (DDC) manufacturer uses another manufacturer's laboratory tracking control system.
2. The DDC manufacturer uses another manufacturer's variable-speed drive chip.
3. The DDC system manufacturer uses a project-specific local control system, such as with a self-contained computer room unit, a remote terminal unit (RTU), and process chillers.

---

## 7.2.4 Controller Networks

### 7.2.4.1 General Controller Network

Controller networks are LANs that connect various grades of controllers. The BAS consists of tiered

controller LANs in that a primary control network shall connect primary controllers and operator interfaces. Secondary networks shall connect secondary or terminal controllers. The secondary control networks communicate with the primary control network by a gateway that is either stand-alone or is packaged in a primary controller. The primary networks are defined as high-speed networks that incorporate peer-to-peer protocols. Secondary networks are slower networks that may depend on a single master device to control the communication on that network; thus, the communications are less reliable and only applicable to less-critical applications.

### 7.2.4.2 Primary Controller LAN

**A. Definition:** A primary controller LAN is defined as high-speed peer-peer LAN used to connect primary controllers which then control larger and more critical equipment and may form gateways to other LANs. These may either incorporate deterministic protocols such as ARCNET (Institute of Electrical and Electronics Engineers [IEEE] 802.4), proprietary Token Ring derivatives, or CSMA/CD protocols such as Ethernet (IEEE 802.3) or LonTalk. In any case, the failure of any one device shall not stop communication on that LAN.

**B. New Facilities:** Each new facility shall include a primary controller LAN provided by either the control vendor or by the institute's data provider. The A/E shall establish limits of responsibility in the design as indicated above.

### 7.2.4.3 Secondary Controller LAN

The Secondary Controller LAN may use polling and/or master-slave scenario because it is not intended to support critical information transport.

### 7.2.4.4 Gateways, Switches, and Routers

The control vendor shall define all necessary gateways, switches, and routers to efficiently segment/architect the LAN. Where controlling LANs are provided by the BAS contractor, the BAS contractor shall provide all devices. Where the controlling LANs are installed by the institute's data provider, the BAS contractor shall specifically define all requirements for segmenting, routing, reliability, etc. Gateways and routers shall be powered by uninterruptible power sources (UPS) and emergency

power to ensure seamless and continuous communication across the LAN.

#### 7.2.4.5 Configuration of Control LANs

**A. LAN Location:** Building architecture and its utility functions shall be adapted to the needs of the BAS. The network components shall be centrally located on each floor and co-located with LAN closets (where applicable) to share vertical and horizontal wire ways.

**B. Control Panel Location:** Control panels shall be located proximate to the equipment they serve to minimize the cost of I/O wiring and piping and make the system less vulnerable. Control panels shall be mounted in protected environments such that they are not subject to physical damage, vibration, or excessive temperature. The equipment rooms, where practical, shall have ambient conditions between 16°C (60°F) and 52°C (125°F) and 10–85% relative humidity. Control panels located in areas exceeding these ranges shall have enclosures with heating or cooling devices to provide the proper environmental conditions.

**C. Panel Access:** The facility engineer must have quick direct access to all control panels to maintain building integrity similar to that provided for fire emergencies without going through tenant spaces. Field panels shall be located out of tenant areas where practical. If field panels are located in tenant areas, they shall be in common areas with easy access. Protection and separation for tenant activities shall be provided.

### 7.2.5 Servers

**A. Description:** As the *DRM* requires client/server architecture, the BAS shall include a server computer to store all the information required by the BAS and manage client access to that server.

**B. Functional Requirement:** The server may be a single computer or a server farm; however, the database shall be common to the entire BAS and allow backup and recovery from one backup system.

**C. Server Criteria:** The server shall allow multiple-user access and manage user access and changes to the common BAS database. The server shall be selected

with reliability, fault tolerance, and processor speed necessary to support the expected number of clients and controllers on the system. The server shall have the disk storage capability to store all the graphics, database, third-party applications, system activity logging and trend archiving required for the application for the entire enterprise. The server will be responsible for meeting the response-time requirements for user access to graphics. The server shall be powered by an uninterruptible source with the capability to maintain the server through power transitions.

### 7.2.6 Operator Workstations

**A. Description:** Operator workstations are primarily passive; they are only used to facilitate human interaction with the control system and do not execute any automatic control. In some cases, the same computer used for the operator workstation may also be used as the gateway or router between the supervisory network and the primary controller LAN. Hardware requirements of the operator workstations are indicated in [Section 7.6 Installation](#).

**B. Placement/Connections:** The following shall be provided with regard to placement of or connections for operator workstations:

1. At least one graphic operator's workstation in the engineer's office of each facility
2. At least one graphic operator's workstation in the building manager's office of each facility
3. At least one connection for a portable graphic operator's workstation in each "major" (as dictated by the PO) mechanical room. The functional intent of these connections is to support maintenance activities from within the room. The connection point shall be clearly labeled.
4. At least one in the animal facility manager's office in the case where the animal facility monitoring is being provided by the client application of the BAS

**C. Functional Requirements:** Functional requirements of the operator workstations are indicated in [Section 7.6 Installation](#).



**D. Client Software:** The architecture of the BAS is to be set up as a client/server. Operator workstations shall either run client software or terminal sessions on the server. The client software may run as either a “thick” or “thin” client. A thick client shall be a software package that is stand-alone, but connects to the server backend databases to serve system information. A thin client is one that shall run through a browser such as Microsoft’s Internet Explorer. A terminal session is one in which the client directly accesses the server and runs an instance of the graphic interface software on the server from a remote computer. Any modifications done to the system via the thin client provided as an operator workstation shall modify the primary server information presuming the user has entered the appropriate password level. If for instance, separate graphics must be produced to support the browser-based interface, the browser-based software does not qualify as either a portable or stationary operator workstation.

**E. TAB Contractor:** For all projects that incorporate a balancing contractor, the control vendor shall provide the TAB contractor with a controls interface hardware and/or software (laptops or personal computers must be provided by the TAB) that facilitates balancing/calibrating flow-controlled systems like VAV terminals. Connections shall be provided from within the zone the terminal is controlling.

**F. Licensed GUI Software:** For all projects, the control vendor shall provide a client version of the GUI software, licensed for the entity that is performing the commissioning activity for the duration of the construction and warranty period. This shall be a license that is then transferred back to the applicable institute. The functional requirement here is to provide full functionality of the GUI software to the commissioning effort. If this can be done via a browser or a terminal session, these are also acceptable.

**G. Portable Operator Workstations:** The requirements shall be coordinated with maintenance staff on a project-by-project basis. A portable operator workstation refers to a laptop computer or a tablet that can fully run the client software, browser, or terminal session as applicable.

**H. Animal Research Facility (ARF) Monitoring Workstations:** The following shall be made available to the veterinarian staff:

1. Real-time GUI to floor plans with all relevant environmental parameters displayed or accessible
2. Real-time (maximum 20 minute lag) alarming of conditions of the relevant environmental parameters
3. Samples and records of the following parameters for each ARF room:
  - a. Temperature (15 minute intervals)
    - i. Animal holding rooms
    - ii. Cage wash
    - iii. Food prep
    - iv. Necropsy and support areas
    - v. Procedure rooms
    - vi. Supply Storage, Clean Cage/Storage, Feed
    - vii. Surgery, Post-op, Support
  - b. Humidity (15 minute intervals)
    - i. Animal holding rooms
  - c. Air change rate (ACR); (15 minute intervals)
    - i. Animal holding rooms
    - ii. Cage wash
    - iii. Food prep
    - iv. Necropsy and support areas
    - v. Procedure rooms
    - vi. Supply storage, Clean Cage/Storage, Feed
    - vii. Surgery, Post-op, Support
  - d. Lighting level (change of value)
4. Alarm information:
  - a. Maintain an alarm log of all parameters currently in alarm and when they went into alarm.

- b. Maintain a daily log recording when they went into alarm, the maximum excursion, and when the alarm condition was cleared.
5. The following reports shall be printed or displayed when manually initiated:
- a. Current alarm summary listing all points currently in alarm
  - b. Daily alarm summary listing all alarms for a selected day
  - c. Daily room summary providing average, high, and low values for temperature, humidity, and ACR
  - d. Lighting report giving on/off value trend
    - i. Animal holding rooms
  - e. Current poll data report for temperature, humidity, supply airflow, exhaust airflow, and ACR
  - f. Room graphs illustrating a 24 hour graph of a room's temperature, humidity, and ACR

---

## 7.2.7 Remote Connections

All BASs shall have the capability to be accessed remotely. The required remote connection might be via the institute's intranet or NIH FACnet. When remotely connected, users shall have the ability with the proper passwords to perform any function on the BAS that they can if locally connected.

## 7.2.8 Intranet Remote Connections

All BASs shall have the capability to be accessed via the applicable institute's Ethernet intranet given appropriate access credentials and rights configured by the data provider applicable to the project. Security requirements of the base system apply to intranet access, in that the server shall only allow a user access to information that has specifically been assigned as available to the user. Examples of acceptable access scenarios include:

1. User uses a browser-based thin client to access servers visible directly on the intranet. Credentials are entered by the user who is then granted access to the appropriate information.
2. User uses a thick client application from a client station on the intranet. The client application connects to the BAS server.
3. User uses a terminal session client to connect to the server and run an instance of the interface software on the server.

# Section 7.3

## Applications

---

### Contents

7.3.0 Introduction

7.3.1 Building-Level Requirements

7.3.2 Zone-Level Requirements

7.3.3 Laboratories

7.3.4 Animal Holding Rooms

7.3.5 General Pressure-Controlled Rooms

7.3.6 Principal Investigator (PI) Offices

7.3.7 Microscope Suites

7.3.8 Nuclear Magnetic Resonance and  
Magnetic Resonance Imaging Suites

7.3.9 Computer Rooms

7.3.10 Environmental Rooms

7.3.11 Electrical Vaults

7.3.12 Loading Docks/Shipping and  
Receiving Areas

7.3.13 Freezer Farms

7.3.14 Laboratory Corridors

7.3.15 Conference/Meeting Rooms

7.3.16 Enclosed Garages

## 7.3.0 Introduction

This section defines general physical input/output (I/O) requirements, sequences, and by inference, some degree of system requirements related to how the BAS is applied to building areas and systems. This section is organized by “element” of the building-service systems and presented from higher-level elements to lower level elements. The elements listed can be configured in various ways to obtain the various systems as dictated in [Chapter 6: Mechanical Design](#). Strict adherence to these requirements will inevitably result in duplicate I/O (i.e., the leaving air side of a coil will frequently be the same as the supply air). The intent is obviously not to provide redundant sensors. The A/E is to exercise professional judgment and common sense in the application of these requirements.

### 7.3.1 Building-Level Requirements

Monitoring at the building level shall consist of the following parameters (points). Coordinate monitoring between the BAS and the utility monitoring system. Not all parameters shall be applicable to all facilities. The A/E shall provide the points applicable.

#### A. Outside Environment:

1. Temperature
2. Relative humidity

#### B. Chilled Water Service:

1. Chilled water supply and return temperature
2. Chilled water supply and return pressure
3. Chilled water flow

#### C. Steam Service:

1. Steam use
2. Steam pressure
3. Condensate flow

4. Condensate temperature
5. Condensate receiver-level alarm

#### D. Electric Service:

1. Electricity use (amperage or meter pulse counter)
2. Supply voltage
3. Network protector status

#### E. Emergency Electric Service:

1. Generator status
2. Generator alarm
3. Generator run status
4. Transfer switch

#### F. Natural Gas Service:

1. Gas use
2. Gas pressure

#### G. Compressed Air:

1. Supply pressure
2. Compressed airflow

#### H. Domestic Water Service:

1. Water use
2. Water service pressure
3. Water load side pressure (after backflow preventer)

#### I. Sanitary Service:

1. Effluent pH level (when cage washing facilities are included)
2. Effluent temperature (where heat-source-effluent decontamination systems are used)

**J. Power Transfers:** When power returns from a power outage or transfer, the systems in the building shall be restarted in priority of criticality with a slight timing delay between starts to minimize the in-rush.

## 7.3.2 Zone-Level Requirements

### 7.3.2.1 General Occupied Zones

**A. Space-Temperature Sensor:** With few exceptions, all zones of control shall require a space-temperature sensor. Zoning shall be dictated by the system design. Most zones shall simply have a space-temperature sensor mounted in a representative location in the zone. Rooms with different thermodynamic characteristics, temperature, humidity, pressure, airflow, and HVAC scheduling requirements shall not be grouped into one zone.

**B. Space-Temperature Adjustment:** In areas that the HVAC systems are scheduled for an occupied/unoccupied cycle, at least one sensor per system shall be provided with an override button. Private offices may include space-temperature adjustment with the thermostat at the direction of the project officer (PO). Anywhere that space-temperature adjustment is provided, the BAS shall allow setting the limits of the occupant's range of allowable adjustment.

**C. Heating/Cooling:** In all cases, the heating and cooling within a zone shall be coordinated to avoid simultaneous heating and cooling. Exceptions include perimeter heat required to provide thermal comfort to occupants sitting near a window wall while the internal load in the space may still require heating or cooling, and dehumidification. If wall-mounted sensors are not practical and duct-mounted sensors are required, install off-the-shelf test ports.

**D. Fail Positions:** Fail positions on the systems that serve these standard environments shall fail to either last condition/position or heating where there is a perimeter wall or some need for heating. Where there is not a need for heating, such as in an internal zone, systems shall fail to either last position/condition or to cooling. Fail positions for animal rooms shall be coordinated with the veterinarian.

**E. Zone Controls:** Controls for a typical zone shall be indicated with the system that serves that zone. For instance, if a zone is served by a 100% outdoor-air VAV system, the temperature control for that zone shall be covered by the air handler and the VAV box. A zone served by a fan coil unit shall be covered by the fan coil

unit element and the chilled water system. Controllers serving terminal devices that serve these spaces shall be application-specific secondary (terminal) controllers fed from normal power.

**F. Electronic vs. Pneumatic Controls:** New non-critical zone-level controls, including sensors, controllers, and actuators shall be electronic. Pneumatic controls shall not be used except for critical applications that require fast response.

### 7.3.2.2 Tri-State Actuators

**A. Tri-State Actuators Requiring Periodic Recalibration:** Tri-state actuators that require periodic recalibration of the motor timing by stroking the actuator shall be used on valves and dampers controlling spaces that do not have tight temperature, humidity, and pressure requirements. These may be used in offices, corridors that are not an essential component of a critical laboratory pressure gradient, conference rooms, break rooms, and analogous types of rooms. They shall not be used on any other type of room without the approval of the PO. They shall specifically not be used in animal-care spaces or in support systems for animal-care areas unless it can be shown that recalibration will not result in temperature swings. Tri-state actuators may be used in the following applications:

1. Laboratory and animal holding room air dampers provided that stroking the damper is not necessary to recalibrate the actuator on a scheduled basis.
2. Animal holding room reheat valves where calibration will not cause excursion beyond acceptable ranges.

## 7.3.3 Laboratories

### 7.3.3.1 Common Laboratory Requirements

**A. Temperature Control/Pressure-Independent-Volume Control:** Laboratory zones shall have temperature control and pressure-independent-volume control. Pressure-independent-volume control shall mean that a set point volumetric flow rate of supply and exhaust into and out of the laboratory shall be automatically maintained

regardless of fluctuations in static pressure, i.e., flow rates shall be determined based on sensor readings and the positions of dampers in the supply and exhaust airstream adjusted automatically to maintain a set-point flow rate.

**B. Zone-Level Humidity Control:** Zone-level humidity control is optional and shall only be provided where required by the program occupying the space.

**C. Zone-Monitored Points:** The monitored points associated with the zone, except for zone-related equipment requirements (see the applicable equipment specification) shall be as follows:

1. Space temperature
2. Common alarms on hoods and/or biological safety cabinets (BSCs)
3. Humidity
4. Supply/exhaust velocity (total/static differential) pressure

**D. Separate Alarms for Fume Hoods/BSCs:** Note that institutes are required to have alarms on fume hoods and BSCs that are separate from the BAS.

**E. Exception:** Laboratories shall have pressure or directional airflow controlled zones. On existing constant volume systems where installation of pressure-independent terminals is not practical, and only with permission of the PO and DOHS, laboratory pressurization may be accomplished by balancing.

**F. Pressure-Independent VAV-Zone Control:** The requirement for pressure-independent VAV-zone control means that each zone shall have pressure-independent-terminal boxes on supply and exhaust. The terminal-box-control damper is controlled to achieve a set point flow rate. The set point flow rate will be automatically varied between a minimum and maximum as necessary to meet the airflow demand of the room. In some cases, an individual room on the system may require a constant flow. In these cases, the minimum and maximum flow rates shall be set to the same value resulting in a constant flow to the room so that any room on the system can be converted from variable to constant volume by changing the control parameters, i.e., the conversion is done from a workstation and not in the field. The air handler shall often serve a combination of variable and constant volume zones.

**G. Negative/Positive Zones:** On new VAV systems, laboratory zones shall be actively controlled by maintaining an offset between the total supply and exhaust flow to the room. On zones that are required to be negative, the supply flow shall track the exhaust flow. On zones required to be positive, the exhaust shall track the supply. Where feedback of the supply and exhaust flow is provided by a correlation to the damper position as in a venturi valve, an input to the system shall indicate when the duct static pressure is insufficient to validate this correlation. Refer to [7.3.5 General Pressure-Controlled Rooms](#).

**H. Less than 100% Redundancy:** When less than 100% redundancy is provided in either a failure mode or an emergency power mode and the pressure is controlled at the zone level, prioritized reset of the terminal flow set points is required to maintain the required room pressurization. When this is the case, the A/E shall dictate the priorities. Controls for laboratories, including control panels and modules, valves, and dampers, shall be fed from emergency power.

**I. Local Space Pressure:** Monitoring of space pressure with local indication is only required when the potential threat to occupant well-being or the research program from airborne contamination is significant and is required by the Centers for Disease Control's Biosafety in Microbiological and Biomedical Laboratories (BMBL) for BSL-3 and ABSL-3 facilities. This shall be discussed with the PO, the DOHS, and the researcher to establish this need.

### 7.3.3.2 Laboratories with VAV Hoods

**A. Laboratory Grade:** When laboratories contain VAV fume hoods, the controller and all devices shall be laboratory grade that can act with the speed of response required to meet the requirements of the NIH fume hood testing protocol as described in [Section 6.1.16.4](#). This will require fast-acting actuators and fast-responding controllers commensurate with laboratory-grade control systems. Conventional VAV terminals may be used for supply and general exhaust provided they are fitted with fast-acting actuators. Laboratory grade VAV terminals shall be used for fume hood exhaust. They can be blade-type, venturi-type or vortex shedding type. In the case of blade-type terminals and vortex shedding type terminals, the exhaust terminals shall be stainless



steel construction with ultra low leakage casing and dampers. Venturi valves shall be constructed of 16 G aluminum with two baked on coats of corrosion resistant coating. Blade-type terminals require minimum of three (3) duct diameter upstream of the sensor. Venturi valves require a minimum of 15 mm (0.6 in.) inlet pressure for the valves to operate properly.

**B. Terminal Box:** Each VAV fume hood laboratory shall have a pressure-independent terminal box on the fume hood exhaust as well as on the supply air duct. If a general exhaust box is required, it shall also be a pressure-independent terminal box.

1. Room temperature shall be maintained by increasing the total zone exhaust airflow set point on a rise in temperature and by decreasing its set point on a fall in temperature (the minimum zone flow set point shall be limited to that required for air exchange).
2. Room temperature shall be maintained by modulating the reheat coil to maintain the heating set point.
3. Room pressurization shall be maintained by varying the supply airflow set point to track the total zone exhaust air being measured (hood flow plus general exhaust as applicable).
4. Exhaust air through the fume hood shall be modulated to maintain an airflow that is required to maintain a face velocity set point. Airflow set point shall be determined by sash position.
5. The general exhaust airflow set point shall vary to maintain the total zone exhaust flow set point when the hood flow is less than that required for the cooling loop.
6. All box dampers shall modulate to maintain the established flow set point.
7. The use of proximity sensors shall not be used on VAV fume hoods. All VAV fume hoods shall be fitted with sash position indicators.

## 7.3.4 Animal Holding Rooms

**A. Animal Care Priority:** Animal care requirements shall always take precedence over system-component protection. Animal holding rooms shall be controlled to temperature, pressure or directional airflow, and humidity on a room-by-room basis as determined by the program.

**B. Monitored Points:** The monitored points associated with the room (for zone-related equipment requirements, see the applicable equipment) shall be as follows:

1. Space temperature
2. Space pressure with local indication (where space pressure is controlled)
3. Space humidity
4. Supply air humidity for high limit (if not done with a local limit) only when trim humidifiers are installed
5. Air change calculation either via terminal flow sensors or flow measuring stations
6. Light-level monitoring, unless not required in this system by PO and program and is monitored in a separate system, shall be considered, but may be part of a separate system as long as the required AAALAC data is stored.
7. Supply/exhaust (total/static differential) pressure
8. Supply and exhaust airflow

**C. Individual Room Humidity:** Humidity control must be stable. The control system shall maintain humidity within  $\pm 5\%$  of set point when the humidifier is being controlled within its limits.

**D. Individual Room-Air Changes:** On new systems, pressure-independent constant volume boxes shall be used to control supply and exhaust flow rates. The direct digital controller (DDC) system controls modulating dampers in the supply and exhaust to maintain flow rates. The BAS shall monitor both supply and exhaust flows.

**E. Airflow Rate into Individual Rooms:** For existing systems where installation of pressure-independent airflow terminals is not practical, the flow rate into

individual rooms shall be maintained by manual adjustments to balancing dampers. The BAS shall still monitor both supply and exhaust flows. An individual flow probe is required for each individual flow. If there is not sufficient room in the ductwork to measure room flow directly, install multiple sensors and determine flow indirectly by subtracting the resultant multiple flows. If the ductwork is not sufficiently accessible or the flow range is too low for accurate measurement, indirectly determine flow by accurately measuring a suite of rooms and prorating the total suite flow by the known air balance which shall be periodically verified.

**F. Individual Room Pressurization:** Individual room pressure shall be controlled by adjusting flow rate at pressure-independent terminal boxes. Supply airflow is modulated to either maintain a flow differential between supply and exhaust or to maintain a constant pressure at a room differential pressure sensor. See [Section 7.3.5 General Pressure-Controlled Rooms](#) for more details.

**G. Individual Room-Space Temperature:** Temperature shall be monitored by the DDC system. The location and protection of the sensor shall be coordinated with the animal program. The sensor shall be located in the exhaust duct unless the location is not representative of the macroenvironment. Provide a high-accuracy sensor. If the sensors must be in the room, the sensors shall be waterproof or in a waterproof enclosure and be protected from physical damage from racks. If in the exhaust duct, they shall be located away from direct cage exhaust so that the sensor is representative of the macroenvironment and not affected by the ventilated rack exhaust blowers.

---

### 7.3.5 General Pressure-Controlled Rooms

**A. Pressure-Controlled Zones:** Many types of occupancies shall require pressure control. Rooms ancillary to other rooms required to be pressure controlled shall need to be pressure controlled themselves to maintain the primary zone. Pressure controlled zones shall sense supply and exhaust airflow. Passive control (supply and exhausts are controlled to a flow set point, with one of the flows slaved to follow the other with an offset) shall be used. Either the supply shall track the exhaust,

(where pressure control seeks to keep the space negative), or the exhaust shall track the supply (where pressure control seeks to keep the space positive). This scenario inherently adjusts to potential failures in, or lack of capacity of the main systems. If the leading system begins struggling for any reason, the following system terminal box shall modulate to maintain the offset.

**B. Airflow Metering:** If airflow is not being sensed directly, as in the application of a metering venturi valve, where the flow is being inferred from valve position, a pressure sensor shall be provided on both supply and exhaust systems that alarms when air pressure across the valve is not great enough to maintain the valve in an appropriate range.

**C. Distress Mode:** For non-containment systems, if the lead system is in alarm for 2 minutes (enough time for an initial attempt at resetting set points) the system shall be put into a “distress mode” such that all pressure zone control set points are reduced to redistribute the lack of capacity in a prioritized fashion. Distress mode shall be alarmed and manually reset.

**D. Lack of Pressure Alarm:** For BSL-3 systems, the lack of pressure shall be alarmed immediately and the distress modes shall be initiated by the pressure sensors provided across the containment barrier.

---

### 7.3.6 Principal Investigator (PI) Offices

Principal investigator (PI) offices shall be controlled to temperature and pressure only when integral to the laboratory pressure control. PI offices shall include a space temperature sensor with local set point override, which shall allow limits applied to the degree of adjustment. These rooms may have a scheduled unoccupied period with local override capability.

---

### 7.3.7 Microscope Suites

**A. Application:** The following does not apply to all microscope suites. It may apply to electron, confocal, or other types of highly sensitive microscopes. Check with the users before designing.

**B. Sensitive Microscope Suites:** Sensitive microscope suites require very tight temperature and humidity control. The design of the controls shall be very closely coordinated with the mechanical system design and the space layout to minimize environmental condition fluctuation across the scope. Either laminar systems or curtains shall be used for this. The typical special microscope room shall require the following monitoring points:

1. Space temperature
2. Humidity
3. Air change calculation either via terminal flow sensors or flow measuring stations

**C. Humidity Requirements:** Humidity requirements shall be coordinated with the microscope manufacturer. If the microscope uses a gas that could potentially spill and displace oxygen or otherwise create a hazard, a sensor detecting either oxygen or the gas being used will be required to initiate a room-exhaust sequence.

**D. Electron Microscopy:** Controls serving the electron microscopy suite shall fail to last position or cooling. Proportional Integrated and Derivative (PID) controllers shall be used in conjunction with Class A, Resistance Temperature Detectors (RTDs) or Thermistors to control room temperature.

---

## 7.3.8 Nuclear Magnetic Resonance and Magnetic Resonance Imaging Suites

Nuclear magnetic resonance (NMR) and magnetic resonance imaging (MRI) suites require stable temperature control in the vicinity of the magnets. The design of the controls shall be very closely coordinated with the mechanical system design and the space layout to minimize environmental condition fluctuation across the magnets. The typical NMR room shall require the following monitoring points:

1. Space temperature
2. Humidity

3. Gas detection coordinated with the NMR/MRI manufacturer
4. An oxygen sensor to initiate a room exhaust if the magnet quenches

---

## 7.3.9 Computer Rooms

Temperature and humidity shall be controlled in computer rooms. When the primary control is provided by the BAS, the requirements are listed with the applicable systems and components. Whether completely controlled by the BAS or whether a combination of packaged controls (as would be provided on a computer room unit) and BAS, the ventilation system shall be coordinated with the computer-room conditioning system, and the various computer-room conditioning units shall be coordinated to not cause simultaneous heating and cooling (unless required for dehumidification). For instance, the discharge condition of a supplemental outdoor-air system for ventilation shall not impose unnecessary humidity (causing cooling and reheating for dehumidification of the computer room units). Humidification control systems shall be coordinated to avoid some systems humidifying while others are dehumidifying. The following at a minimum shall be monitored by the BAS:

1. Common alarm on the computer room unit
2. Space temperature
3. Space humidity
4. Under floor water if not included in the common alarm

---

## 7.3.10 Environmental Rooms

Environmental rooms shall be provided with packaged controls. These rooms shall be monitored by the laboratory equipment monitoring system.

### 7.3.11 Electrical Vaults

The BAS shall control ventilation in electrical vault rooms to maintain acceptable temperature in the spaces. The requirements are listed with the systems and components. The BAS shall include space temperature monitoring and alarming and liquid sensing and alarming.

### 7.3.12 Loading Docks/ Shipping and Receiving Areas

The BAS shall control the loading dock area to temperature as dictated by the system design. It shall also include a carbon monoxide (CO) sensor to alarm upon high levels of CO and initiate additional ventilation as required by the system design.

### 7.3.13 Freezer Farms

In addition to the points required for the HVAC control system, BAS shall monitor the oxygen level in freezer storage space and alarm when the level drops below a safe level as specified by the Occupational Safety and Health Administration (OSHA). When emergency exhaust is provided, the BAS shall energize the emergency exhaust when the critical level is reached. Refer to [Section 6.1.18](#).

### 7.3.14 Laboratory Corridors

**A. Protected Sensor Location:** Laboratory corridors are subject to high traffic; sensors in the space shall be protected and placed in a representative location.

**B. Sensor Location Alternatives:** Laboratory corridors are used to manage pressurization in adjacent laboratory zones, and as such, may not have exhaust or return air. The alternatives for locating the temperature sensor include:

1. In protected representative location, or
2. In the supply air of the terminal supplying this pressurization air. In the case of the sensor in the supply air, the zone would be set to supply approximately 19°C (66°F).

### 7.3.15 Conference/Meeting Rooms

Control shall be closely coordinated with system design and include temperature and ventilation control. Adequate ventilation shall be ensured by either occupancy sensing and indexing the ventilation to the ASHRAE 62 prescribed value upon occupancy or by active control of carbon dioxide (CO<sub>2</sub>) and modulating ventilation rates to maintain CO<sub>2</sub> rates below a prescribed value. Ventilation systems shall include controls, manual or automatic, that enable the fan system to operate whenever the spaces served are occupied while maintaining space temperature in the comfort zone as defined by ASHRAE.

### 7.3.16 Enclosed Garages

The BAS shall monitor and alarm high Carbon Monoxide (CO) levels in enclosed garages. When the BAS controls garage ventilation, it shall start/stop and sequence fans as required to maintain acceptable CO levels.

# Section 7.4

## Systems-Level Requirements

---

### Contents

- 7.4.0 Introduction
- 7.4.1 General Requirements
- 7.4.2 Air Handling Systems
- 7.4.3 Stairwell Pressurization Systems
- 7.4.4 Exhaust Air Systems
- 7.4.5 Building Steam Connections to Campus System
  - 7.4.5.1 Modulating Steam Valves
- 7.4.6 Clean Steam (Steam Source Boiler and Steam-to-Steam Generator) Systems
- 7.4.7 Hydronic Systems
  - 7.4.7.1 Steam-to-Water Hydronic Systems
  - 7.4.7.2 Chilled Water Hydronic Systems
- 7.4.8 Plumbing and Specialty Gas Systems
  - 7.4.8.1 Domestic/Laboratory Water Systems
  - 7.4.8.2 Drainage and Waste Systems
  - 7.4.8.3 Centrally Stored Laboratory Gas Systems
- 7.4.9 Fuel Oil Systems
- 7.4.10 Laboratory Air Systems
- 7.4.11 Control Compressed-Air Systems
- 7.4.12 Vacuum Systems
- 7.4.13 Desiccant Dehumidification Systems
- 7.4.14 Electrical Systems
  - 7.4.14.1 Emergency Power Systems
  - 7.4.14.2 Central Uninterruptible Power Supply Systems
  - 7.4.14.3 Lighting Control Systems
  - 7.4.14.4 Grounding Systems

## 7.4.0 Introduction

This section describes the control loops that form the system and how the separate loops work to form the overall system. Systems are composed of components. Many of the requirements of the systems are specified as a part of the component specification. This section provides the requirements of the composite system. The controller for system-level requirements shall be powered by the highest level of the power available to any of the components or devices it serves. Specific requirements of the controllers are listed with the system.

---

### 7.4.1 General Requirements

The A/E shall coordinate the reliability requirements (with regard to stand-alone capability, single sources of failures, and controller level) with the PO and clearly state the requirements in the documents.

---

### 7.4.2 Air Handling Systems

Section 7.4.2 refers to air systems that have airflows in excess of 1180 L/s (2500 cfm) or as directed by the project officer (PO). The requirements for terminal units such as fancoil units are indicated in [Section 7.5.16 Miscellaneous Terminal Units](#).

**A. Discharge Air Temperature:** All systems require discharge air-temperature sensors. Supply air systems serving multiple terminal units, particularly those that serve terminals that involve reheating shall include a supply air reset algorithm. Reset may be based on either outside air temperature or feedback from the terminals. Where control is based on feedback from the terminals, logic shall prevent a single box from controlling the entire system unless it is critical. The reset logic shall be designed to allow dehumidification demand to override heating and cooling demand and vice versa depending on which is greater.

**B. Interface to Fire Alarm System:** Systems shall be interfaced with the fire alarm system where required by code. When a fireman's override is required, the freeze safety shall be bypassed (although the basic sequence shall ensure that all coils have full flow in the event of

a potential freeze condition). The smoke safety shall remain in effect. The pressure safety shall also remain in effect unless it is unlikely that the extreme pressure could render the unit inoperable.

**C. Smoke Control Sequences:** Where an engineered smoke control sequence is applicable, BAS may be used to execute the sequences only if it maintains a UL 864 certification. Otherwise, the fire alarm system shall locally override all devices via addressable modules.

**D. Controller:** Individual air handling units (AHUs) shall be controlled by one single controller with stand-alone capability. All programming controlling the components on the air handler shall be contained in a single controller and be provided via one programming language. Only outside air conditions, emergency power indications, and as permitted by the PO, terminal-based reset parameters may be required across the network. For certified smoke control systems, smoke modes and zone alarms may be allowed over the network. Units serving research laboratory areas, ARFs, BSL-3 areas, aquatic laboratories, NMR suites, electron microscope suites, cleanrooms, manufacturing/process facilities, and other areas of commensurate criticality shall be controlled by a primary controller. The A/E shall coordinate the reliability requirements with the PO and clearly state the requirements in the documents.

**E. Humidity Control:** Air systems that include humidity control shall include a humidity control sensor and high limit humidity sensor in the supply air duct separated by an adequate distance from the humidifier. If jackets are used on the dispersion tubes of the humidifier, provide an automatic means of isolating the humidifier jacket when the dewpoint of the outside air is below the applicable set point.

**F. Interlock with Exhaust:** Supply air systems that work in concert with exhaust systems shall be interlocked with that system. Exhaust system status is required before the supply air system starts for 100% supply and exhaust systems serving areas that are required to be maintained negative to public spaces. Where the response must be quick, such as the shutdown of the supply fan for a BSL-3 lab when the exhaust system shuts down, the equipment should be controlled from the same BAS cabinet, or hard-wired interlocks may be necessary because communication across the network is not always fast enough to be effective.



**G. Startup and Staging:** The BAS shall provide for smooth and orderly startup and staging (where applicable) of the AHUs. The starting of the fan and the opening of associated dampers shall be carefully coordinated. For variable air volume (VAV) air handlers, the fans shall start at minimum capacity and ramp up to capacity at a controlled rate. When applicable, end switches on the dampers shall prove damper status before allowing the fan capacity to exceed an unsafe condition and/or exceed a pressure safety setting. Main air to normally open control valves shall not be dropped when the fan is off.

**H. Isolation and Security:** Air handlers with outside air capability shall have outside air dampers that shall close when the system is off. Supply isolation and smoke dampers shall be provided as required by National Fire Protection Agency's code standard 90 (NFPA 90). For specific security requirements, coordinate with DPSM. See [Section 1.13](#).

**I. Freeze Protection:** All air handling units (AHUs) shall have a two-pole freeze stat with manual reset. One is required for every 3.7 m<sup>2</sup> (40 ft.<sup>2</sup>) of coil surface. The freeze stat shall trip when any area of the preheat coil discharge drops below 6°C (42.8°F). One pole shall be hard wired to the motor starter or drive and the other shall be wired to the direct digital control (DDC) panel. When the freeze stat trips, the supply fan shall stop and dampers shall close (unless in fireman's override), and then preheat, chilled water, and reheat valves (for coils within the unit) shall open fully. The freeze stat shall have a time-delay relay in the circuit to delay the trip for an adjustable time up to 5 minutes and a manual reset, which is required to restart the fan and return the freeze stat point to the normal status. Where required, BAS shall include provision of leak detector around AHU to alert maintenance of a potential leak.

**J. Cabinet and Component Pressure Safety:** When the dead head of the fan is capable of damaging the wall, component, or duct associated with the system, upon closure of any isolation or fire damper, the air handler shall be protected with applicable high and/or low differential pressure safety switches with manual reset. Note that given free wheel of the fans, the static pressure safeties cannot absolutely guarantee damaging conditions. Therefore, the A/E shall provide for protection of system components in the event abnormal conditions develop (e.g., relief panels).

**K. Scheduling:** When feasible in areas that are not occupied at all times and where code permits, the control sequence shall incorporate scheduling and setback to minimize energy use.

**L. Supply Air Pressure Control:** A sensor that is at about two-thirds the length of the supply main or a location that is representative of the system pressure shall monitor supply air pressure. Supply pressure shall be controlled to maintain a set point that allows optimal control with minimum energy consumption.

**M. Headered Systems:** Headered systems are those that have multiple air handlers or fans feeding a common supply distribution system. Critical systems described below refer to systems serving fume hoods, BSCs, ARFs, and containment and high containment systems:

1. The BAS and/or a local controller shall be capable of selecting any of the headered fans as the lead fan and shall select one of the headered fans as the lead fan.
2. When starting a fan controlled by a variable frequency drive (VFD), the fan shall be started into a closed damper to equalize the pressure up- and downstream of the damper and prohibit backspin of the fan. When the speed of the fan crosses a threshold speed (indicating "fan running") and static pressure proves fan operation, isolation dampers shall be opened. End switches on isolation dampers shall limit the speed of the fan to a safe preset condition, but near the typical header operating pressure. When the damper end switches indicate an open damper, the VFD shall allow acceleration of the fan beyond the preset condition. The VFD shall command open and close of the motorized isolation damper.
3. The control system shall control all operating fans (of equal capacity) on a header to a common speed. The network can be used to coordinate the speed of the fans, however, the controller shall revert to a local control loop in the event of loss of network communication. Upon loss of communication, an operating fan shall continue to operate and revert to its local loop or maintain the last known command. If the fan is not operating at the point when communication is lost, it shall remain off until communication is restored and it is commanded to run.

4. The lead shall be rotated automatically.
5. The lead rotates automatically upon failure of the fan. On scheduled rotation, the lag shall start and prove status before the stopping fan is stopped.
6. Anytime a fan fails or a startup sequence fails, the BAS shall generate an alarm and the alarm status shall continue until manually reset even if subsequent attempts at startup succeed. When the fan fails or the start sequence fails, isolation dampers shall be commanded closed, and the BAS shall initiate one retry to start the fan. If the fan again fails to start, the BAS shall initiate a start sequence on a backup fan. If backup fails to start after two start tries, the BAS shall repeat attempting to start one fan and then the other until one starts or the fan sequence is manually overridden.
7. For critical systems, extra fans on a manifold/header shall be run continuously at a lower speed and when one fan fails, it shall be isolated, the BAS shall generate an alarm, and the other fans shall speed up to meet the system set-point pressure.
8. VFDs shall be controlled directly by the BAS controller via hard-wired interface, not across the control LAN through manufacturer-provided controllers that are integral to the VFD.
9. Status shall be proved by current switches. Switches sensing proof on critical systems shall be capable of sensing a loss of status due to a belt break, as well as any other loss of status in 10 seconds. The application shall be analyzed by the A/E to assess if the minimum operating current to exceed a no-load-motor amp draw at 60 Hz (broken belt scenario). If a reliable current switch amp setting cannot be determined based on the application, proof logic shall be supplemented with either pressure switches or drive logic.
10. On headered systems that may result in higher than design airflows during a condition like failure of another fan on the header, the BAS shall limit the operating fan speed to a safe volume that shall not result in excessive filter forces or water carryover from a condensing cooling coil.

**N. Airflow Monitoring:** Supply airflow shall be monitored by the BAS with an airflow monitoring station on all systems above 2360 L/s (5,000 cfm) or critical environment required by the program.

**O. Supply Air System to BSL-3 Labs:** Refer to [Section 7.7.5 BSL-3 Laboratories: Supply Systems](#).

---

### 7.4.3 Stairwell Pressurization Systems

When required by code or a performance-based fire protection design, building systems shall include a stairwell pressurization system. This shall be initiated by the fire alarm system whenever an alarm condition occurs. The BAS shall monitor the command and status of the fan and enunciate an alarm when status does not match command.

---

### 7.4.4 Exhaust Air Systems

The following is required for exhaust air systems that have airflows in excess of 1180 L/s (2500 cfm) or as directed by PO.

**A. Interface to Fire Alarm System:** Systems shall be interfaced with the fire alarm system as required by NFPA and the authority having jurisdiction (AHJ). As required, the operation of the fans and dampers shall be controllable by the fire alarm command center. If the building is not equipped with a fire command center, the manual controls for the fans and dampers shall be located per direction of the fire protection AHJ. Where the Division of the Fire Marshal (DFM) has jurisdiction, fume hood exhaust systems remain in operation during fire scenarios.

**B. Smoke-Control Sequences:** Where an engineered smoke-control sequence is applicable (typically these systems are not used in laboratories; however the DFM shall dictate their necessity), the BAS may be used to execute the sequences only if it maintains an Underwriters Laboratories UL 864 certification. Otherwise, the fire alarm system shall locally override all devices via addressable modules.

**C. Controller:** Exhaust systems shall be controlled by one single controller with stand-alone capability and all programming shall be provided via one programming language. Units serving research laboratory areas, ARFs, BSL-3 areas, aquatic laboratories, NMR suites, electron microscope suites, cleanrooms, manufacturing/process facilities, and other areas of commensurate criticality shall be controlled by a primary controller preferably the same as controls the supply (this shall be limited by size).

**D. Interlock with Supply:** Exhaust air systems that work in concert with supply systems shall be interlocked with that system. Exhaust system status shall be required before the supply air system starts for 100% supply and exhaust systems serving areas that are required to be maintained negative to public spaces. Exhaust systems shall be required to have their output limited until supply system status is indicated so as not to create an excessive negative pressure. This shall be done where possible at the terminal level.

**E. Startup and Staging:** The BAS shall provide for smooth and orderly startup and staging (where applicable) of the exhaust fans. The starting of the fan and the opening of associated dampers shall be carefully coordinated. For VAV exhaust systems, the fans shall start at minimum capacity and ramp up to capacity at a controlled rate.

**F. Isolation:** Exhaust systems shall be provided with automatic dampers to close and isolate the system when the system is off.

**G. Component Pressure Safety:** When the dead head of the fan is capable of damaging one of the components, or duct associated with the system, upon closure of any isolation or fire damper, the system shall be protected with applicable high and/or low differential pressure safety switches hard wired to the starter circuit. Note that given free wheel of the fans, the static pressure safeties cannot absolutely guarantee damaging conditions. Therefore, the A/E shall provide for protection of system components in the event abnormal conditions develop (e.g., relief panels).

**H. Scheduling:** When feasible in areas that are not occupied at all times and where the code permits, the control sequence shall incorporate scheduling and set-back to minimize energy use.

**I. Headered Systems:** Headered systems include multiple air handlers or fans that feed a common supply distribution system. Refer to [Section 7.4.2 Air Handling Systems](#). The same applies to the exhaust system.

**J. Airflow Monitoring:** Exhaust airflow shall be monitored by the BAS on all systems above 2360 L/s (5000 cfm) or critical equipment required by program.

**K. Security:** A/E shall include design provisions to meet IT security requirements. Refer to [Chapter 11](#).

**L. Fume Hood and BSC Exhaust Air Systems:** Systems that exhaust fumes from laboratory fume hoods shall be designed and controlled to maintain transport velocity in the ductwork. This shall be coordinated with the system design. See also [7.5.11 Exhaust Air Stacks \(Contaminated Systems\)](#). Sensors for fume hood systems shall be selected for corrosion resistance and for the appropriate hazard in the duct. Control sequences shall start these systems first when restarting after failures and power transfers. Dampers in these systems shall fail open.

**M. Exhaust Systems Serving BSL-3 Laboratories:** Refer to [Section 7.7.6 BSL-3 Laboratories: Exhaust Systems](#).

**N. Laboratory Exhaust System:** The velocity of the exhaust air in the exhaust stacks shall be controlled to maintain adequate dispersion to prevent re-entrainment in air intakes. When systems are constant volume, no monitoring is necessary. When systems are VAV, and bypass air is used to maintain the stacks at constant volume, no monitoring is necessary. If the minimum velocity is maintained by staging fans systems or by a combination of bypass and staging of fans, airflow velocity and flow shall be required. Sensors for laboratory exhaust system shall be corrosion resistant for the appropriate hazard level in the duct.

---

## 7.4.5 Building Steam Connections to Campus System

This section refers to extensions of the plant steam into various facilities. See [Section 7.3.1 Building-Level Requirements](#) for the steam service metering and main condensate system requirements. The BAS shall

monitor each pressure stage at the header and have alarms set for them.

### 7.4.5.1 Modulating Steam Valves

**A. Modulating Control Valves:** Modulating control valves selected for steam heating shall be sized for proper control. They shall have an equal percentage or linear characteristic and be sized for a pressure drop of approximately 75% of the supply steam pressure.

**B. Steam Modulation:** If steam modulation is used as the only means of capacity control, two valves shall be provided in a 1/3 to 2/3 arrangement to improve controllability. One BAS output may be used for both valves provided ranges on valves are carefully coordinated. Control loops shall be tuned at light load and checked under heavy load.

***Rationale:** Both equal percentage or linear inherent characteristic valves may work for this application. The A/E shall evaluate the system and select the right control valve to achieve overall linear install system characteristics. Equal percentage valves are typically used for control applications where wide-load variations can occur. Linear valves are typically used for a linear application, such as the relatively small systems without large load variation.*

## 7.4.6 Clean Steam (Steam Source Boiler and Steam-to-Steam Generator) Systems

**A. Monitor/Alarm Pressure:** The BAS shall monitor and alarm (high and low) the pressure produced by the boiler and steam-to-steam generator. The BAS shall also alarm on both high- and low-water-level conditions in the steam drum/vessel.

**B. Packaged Controls:** When packaged controls are provided, the BAS shall also monitor an overall alarm condition point from the packaged controls. When the BAS controls the systems, the requirements shall be specified with the components.

**C. Makeup Water:** Makeup water shall be preheated for these systems to improve level control. When this is the case and the preheaters are controlled by the BAS, the status of flow to the system shall be monitored by the BAS to enable/disable feed-water control based on water flow. Modulating makeup controls shall provide a more stable system and are recommended.

**D. Clean Steam Systems:** Clean steam systems shall control an automatic surface blow down to purge the system of solids. Control may either be timed or be continuous and controlled by a conductivity controller. Controls shall be provided to cool down the water below 60°C (140°F) before drainage.

## 7.4.7 Hydronic Systems

**A. Static Pressure:** At least one key point of static pressure shall be monitored and a low alarm shall be set at the point when any valve will be struggling to maintain its required flow.

**B. Supply/Return Temperatures:** The supply and return temperatures shall be monitored on all systems.

**C. Flow Monitoring:** Flow shall be monitored on most systems; however, exceptions may be granted by the PO in conjunction with the DTR where there is no value to diagnostic monitoring or measurement and verification.

**D. Control Sequence:** The control sequence for the hydronic loops shall control the source component(s) to maintain a supply temperature that is reset when this is feasible for the system being served. Guidance on reset strategies is included with specific systems.

**E. Heat Exchangers:** If redundant heat exchangers on cooling systems are provided, they may simply remain active all the time. On steam-source heating components, however, the minimum-required heat-exchange surface shall be active at any time. This shall require automatic isolation of the various converters.

**F. Redundant/Staged Pumps:** When hydronic systems include redundant or staged pumps, the sequence shall provide for automatic start of the backup pump on failure, stopping the backup pump when it is no longer needed, rotation of the lead device, as well as maintenance lock out.

**G. Primary Controller:** Systems that require control by a primary controller shall be designated. Typical systems that shall require primary controllers will be systems that serve critical spaces or many spaces such that the expense is justified.

**H. Water Detection Monitoring:** Water detection of drip pans under hydronic piping over electrical switchgear and electrical rooms shall be monitored.

#### 7.4.7.1 Steam-to-Water Hydronic Systems

**A. Isolating Flow from the Converter(s):** Controls shall facilitate automatically isolating flow from the converter(s) that are not needed for capacity. This shall mean a single two-position valve shall be provided on the water circuit to each converter when one is redundant. Automatic sequencing of the backup component, as well as rotation of the lead and maintenance lockout shall be included in the sequence.

***Rationale:** Isolation flow from the converters that are not used can reduce the control loop gain and make the system easier to tune.*

**B. Reset Strategies:** Reset strategies for heating systems shall be as follows:

1. Reset shall be based on terminal requirements when the terminals are controlled by the BAS, the quantity is manageable, and the terminals are dedicated to one secondary controller LAN or primary controller.
2. Reset of perimeter systems that do not incorporate terminal reset shall be based on outside air temperature.
3. Reset for dedicated glycol preheat systems shall be based on outside air temperature.

#### 7.4.7.2 Chilled Water Hydronic Systems

**A. Campus Chilled Water Connections:** The control of the plant chilled water connection for new facilities shall be carefully coordinated with the design and site utility requirements through the PO. The connection and controls shall be designed to maximize the facility's temperature differential and reliability and avoid adverse impact on the distribution system pressures and

temperatures. Regardless of the connection configuration, the building chilled water control valve shall be selected for high turn-down ratios and proper control across significant plant-pressure differentials. The A/E shall specifically present an analysis predicting the valve flow versus percent stroke on the specified valve at various plant differentials. The building valve shall be normally open. Multiple staged valves may also be used to improve control.

**B. Monitoring:** On the system (campus) side, the following shall be monitored:

1. Supply temperature
2. Return temperature
3. Supply pressure
4. Return pressure
5. Flow rate
6. Control-valve position

On the load side (building side of bridge), the following shall be monitored and where appropriate, controlled:

1. Supply temperature
2. Return temperature
3. Pump speed
4. Flow rate
5. System differential pressure

**C. Building-Supply Temperature:** The building supply temperature shall be controlled based on a reset offset from campus supply temperature (for instance, campus plus two in warm weather reset to campus plus five in cool weather) to maximize differential temperature on the campus side while meeting critical cooling and dehumidification load requirements on the building side.

**D. Stand-Alone Chilled Water Plant:** In facilities where a chilled water plant is provided, control coordinating the operation of the overall plant shall be done with a primary controller. The details of the control of a stand-alone plant are not covered by the *DRM*.

**E. Process-Cooling Water Systems:** Process-cooling systems shall be controlled by a primary controller. Upon plant-chilled water failure, the BAS shall sound an



alarm and automatically shift the systems to the alternate cooling source (i.e., domestic water or dedicated cooling tower). The backup cooling source shall also be controlled to maintain process cooling supply temperature. For precision temperature controls requirements refer to [Section 6.3](#). To revert back to plant chilled water requires manual acknowledgment.

**F. Isolation Valves:** The A/E shall carefully select the domestic water and chilled water isolation valves to ensure adequate close-off pressures.

**G. Run-Around Heat Recovery Systems:** Run-around heat recovery systems shall be designed and controlled to maximize the energy-efficiency of the system. Heat-recovery-system controls shall be powered from the same source as the systems that contain them. Run-around heat recovery should be separated from the pre-heat coil. Four modes of operation shall be used:

1. **Winter Mode:** Winter mode shall be used when the outside-air temperature is below the supply air set point minus 3°C (37.4°F). Pump shall run and flow shall be modulated to maintain the supply air temperature leaving the heat recovery coil at a set point coordinated with the other loops in the supply system.
2. **Intermediate Mode:** Intermediate Mode is used when the outside-air temperature is above the supply air set point and below the return/exhaust air temperature plus an offset to adjust for the cost of running the pump versus the recovered heat. In this mode, the pumps shall be off.
3. **Summer Mode:** When the outside air temperature (or enthalpy) is above that indicated for the high side of the intermediate range, the pumps shall run at maximum capacity and the flow shall be maximum.
4. **Exhaust Freeze Protection:** BAS shall modulate the bypass valve to maintain the return temperature (glycol entering the exhaust coil) above 0°C (32°F).

**H. Steam to Hot Water Converter:** If a steam-to-hot water converter is used to inject heat into a heat-recovery loop to form a combination heat recovery and pre-heat system, the converter leaving temperature shall be controlled to maintain the preheat air temperature at

an offset of slightly below the preheat air temperature set point such that one valve shall be fully open and its loop shall be lacking before heat is added to the loop. Refer to [Section 6.1.23](#), as combination preheat and heat recovery should be avoided.

***Rationale:** Combined run-around heat recovery and preheat coil generally have a higher failure rate because of the system complexity. Run-around heat recovery should be separated from the preheat coil. Careful coordination is required for the existing combination heat recovery and preheat system.*

**I. Preheating Set Point:** When preheating load falls and recovered heat is sufficient, the preheating set point shall be lowered to avoid unnecessarily adding heat into the loop.

## 7.4.8 Plumbing and Specialty Gas Systems

**A. Local Alarms/Packaged Alarms to BAS:** Except where individual, specifically identified alarm signals are sent to BAS, alarms from local monitoring panels or other sources shall alert to the BAS in a manner that provides indication of the fault criticality, (e.g., General Fault, Critical/Plant Emergency, etc.). All annunciators to BAS shall be configured to provide alert even under failure conditions (such as loss of power).

### 7.4.8.1 Domestic/Laboratory Water Systems

Refer to [Chapter 8: Plumbing Design](#) and [Chapter 12: Special Process Piping Systems](#) for additional requirements. When systems include booster pumps and packages, the BAS shall monitor the supply pressure and temperature as well as a common alarm on the booster pump package (the assumption being that the booster system includes packaged control). The requirements stated in this section identify general requirements. Additional items and monitoring shall be provided in conformance with the requirements of individual systems as identified in other chapters of the *DRM*.



### 7.4.8.2 Drainage and Waste Systems

**A. Sump Pumps/Lift Stations:** Where the drainage system includes sump pumps or lift stations, the BAS shall, at a minimum, include level switches to monitor the high sump/basin level. Where the BAS controls the systems (when they are not furnished with packaged controls), the BAS shall control the components of the systems. Comply with additional requirements of [Section 8.4 Drainage Systems](#).

**B. Neutralization System:** Where the drainage system includes a neutralization system with packaged controls, the BAS shall, at a minimum, monitor a common alarm from the packaged controls. pH levels shall be alarmed as part of the complete application. If the packaged system alarms on pH excursions, the BAS monitoring of the common alarm will suffice. Where no alarm is provided on the packaged system for pH excursions, the BAS shall include an analog pH sensor and alarm upon excursions beyond the ranges dictated by the Division of Environmental Protection (DEP), for example below pH 6 or above pH 10.

### 7.4.8.3 Centrally Stored Laboratory Gas Systems

The BAS may monitor packaged controls on these systems for common system alarms if requested by the institute and agreed to by NIH in writing. These alarms shall be enunciated on the BAS. In some cases, laboratory gas systems are owned and operated by a scientific program and are not part of the BAS.

### 7.4.9 Fuel Oil Systems

The BAS shall monitor the level in any primary storage tanks (not day tanks). The BAS shall alarm in the case of a spill or any containment breach. The BAS shall alarm in the case of transfer pump failure and or over temperature. Frequently these alarms can come from an interface to packaged transfer pumping or level and leak-monitoring systems specified with the equipment. When the transfer pumping is controlled by the BAS, the requirements are specified with the components.

### 7.4.10 Laboratory Air Systems

The BAS shall monitor and alarm the air supply pressure to the system as well as the dewpoint. The BAS shall also monitor the common alarm from the packaged sequencing controls. See [Section 12.3 Compressed Gas and Cryogenic Systems](#) for additional requirements. The BAS shall also include a high-differential-pressure-switch alarm on the main supply air filter (the physical differential pressure (DP) sensor may be included with the system package, but the alarm shall be indicated on the BAS).

### 7.4.11 Control Compressed-Air Systems

**A. Pressure Sensors:** Control air systems shall include a pressure sensor to monitor supplied control-air pressure. Alarms shall be established for low-pressure conditions that will have an impact on BAS control.

**B. Packaged Control System:** Where a packaged control system is used, the BAS shall monitor a common alarm from the compressed air skid. The BAS shall also monitor a common alarm from the air dryers.

### 7.4.12 Vacuum Systems

The BAS shall monitor and alarm the main vacuum system. The BAS shall also monitor the common alarm from the packaged sequencing controls. Where high-efficiency particulate absorption (HEPA) filters are in place for containment and high containment applications, the BAS shall monitor and alarm the differential pressure across the filter. See [Section 12.4 Laboratory Vacuum Systems](#), for additional requirements.

### 7.4.13 Desiccant Dehumidification Systems

Desiccant dehumidifiers for specialty laboratories may come under the jurisdiction of the ORF or the institute. The BAS shall monitor at a minimum the

discharge temperature, discharge humidity of conditioned air, entering and leaving process air temperature, space humidity that is the primary control variable for the system, and common alarm on packaged control systems. High and low alarms shall be configured for discharge temperature, discharge humidity of conditioned air, and space humidity. In cases where desiccant dehumidifier is dedicated to a program, it shall not be monitored by the BAS.

---

## 7.4.14 Electrical Systems

### 7.4.14.1 Emergency Power Systems

**A. Emergency-Position Status Monitor:** See [Chapter 10: Electrical Design](#) for the emergency-service-monitoring requirements. The status of the emergency-power feed on the transfer switches shall be monitored and indicated on a graphic in the BAS (at a minimum the transfer switches that serve mechanical equipment shall be monitored). This emergency-position status monitor shall be provided directly to a primary controller. Careful consideration shall be given to the propagation of that information to controllers as they reboot from a power interruption. This may require certain critical controllers to be powered from uninterruptible power to ensure rapid propagation of the emergency status.

**B. Controlled Stop Power Transfers:** Consideration shall also be given to anticipating power transfers to allow systems to be commanded to a controlled stop before transfer to avoid the potential of unpredictable behavior on short-duration outages. Monitoring of transfer switches in the emergency position will not suffice for this. The A/E shall carefully coordinate the interface between the transfer switch or supervisory control and data acquisition (SCADA) system controlling the emergency power system and the BAS.

### 7.4.14.2 Central Uninterruptible Power Supply Systems

The BAS shall monitor Central Uninterruptible Power Supply Systems. Monitoring shall include basic status, common alarm, and battery voltage. In cases where uninterruptible power systems are dedicated to a program, it shall not be monitored by the BAS.

### 7.4.14.3 Lighting Control Systems

Lighting control systems shall be both automatic and manual. Automatic lighting control systems shall be programmable and provide user interface with the BAS when required by the program.

### 7.4.14.4 Grounding Systems

Provide an active ground monitoring system connected to the BAS system to continuously monitor the integrity of the grounding system. Refer to [Section 10.6.4 Grounding](#) for detailed electrical requirements.

# Section 7.5

## Component-Level Requirements

---

### Contents

7.5.0 Introduction

7.5.1 General Requirements

7.5.2 Fans

7.5.2.1 Fans Controlled by Starters (With Associated Isolation Dampers)

7.5.2.2 Fans Controlled by Variable Frequency Drives (with Associated Isolation Dampers)

7.5.3 Variable Frequency Drives

7.5.3.1 VFDs in Critical Applications

7.5.4 Pumps

7.5.5 Coils (in AHUs over 1,500 L/s [3,180 cfm])

7.5.5.1 Preheat Coils

7.5.5.2 Chilled Water Coils

7.5.5.3 Reheat Coils

7.5.6 Converters

7.5.7 Heat Exchangers: Fluid to Fluid

7.5.8 Humidifiers

7.5.9 Exhaust Air Ducts

7.5.10 Filter Racks (Including Pre-, Final, and HEPA)

7.5.11 Exhaust Air Stacks (Contaminated Systems)

7.5.12 Heat-Recovery Wheels

7.5.13 Variable Air Volume/Constant Volume Terminals

7.5.13.1 Serving Zones with VAV Fume Hoods

7.5.13.2 Reheat Control Valves

7.5.13.3 Floating Control Damper and Valve Actuators

7.5.13.4 Recalibration of Airflow Pressure Transducers

7.5.14 Fume Hoods

7.5.15 Ducted Biological Safety Cabinets

7.5.16 Miscellaneous Terminal Units

7.5.17 Active Chilled-Beam Terminal Units

7.5.18 Glycol Run Around Heat Recovery Coils

## 7.5.0 Introduction

This section lists BAS requirements by component.

### 7.5.1 General Requirements

BAS devices are not to be duplicated if two requirements indicate the same application.

### 7.5.2 Fans

#### 7.5.2.1 Fans Controlled by Starters (With Associated Isolation Dampers)

**A. Hand-Off-Auto Switch:** A hand-off-auto (HOA) switch shall be provided in the starter of the fans. Any applicable fireman's override shall override any HOA switch function. Otherwise, the HOA shall control the fan as follows:

1. In the hand position, the fan shall start and run continuously unless a safety device trips.
2. In the off position, the fan shall stop.
3. In the auto position, the BAS shall control the fan as indicated below.

**B. Isolation Damper:** The BAS shall control starting and stopping of the fans. Fan starting shall be coordinated with any associated isolation damper, only starting (or accelerating beyond a safe speed in the case of headered systems) after the damper is open far enough to not damage the system or trip a pressure safety. If at any time during the fan operation the damper open indication is lost, the fan shall be de-energized. On headered systems, the isolation damper opening shall be coordinated to prevent back-flow to the extent practical.

**C. Fan Alarms:** Status shall be monitored via the appropriate type of current switch and the BAS shall prove operation. The BAS shall enunciate a "fan failure" alarm whenever the fan is commanded to run and status is not proved within an adjustable debounce time. The BAS shall enunciate a "hand operation" alarm when the fan is commanded Off and On status is indicated. In the "fan failure" mode, the on command shall remain

except on headered systems where it will be switched to stop and isolation dampers closed to prevent backflow. In no case shall a loss of status coincident with a loss in power be alarmed as a failure.

**D. Fan Capacity Modulation:** BAS shall modulate the capacity device in response to the system static pressure sensed at a location(s) remote from the fan. The location of the remote-sensing device shall be indicated by the A/E on the design documents and the final location shall be identified on the record control drawings. The set point shall be reset based on terminal requirements when practical (this will not be practical when serving variable air volume (VAV) fume hoods, for instance, because the terminal requirements vary too rapidly). Programming shall be in place to avoid one terminal device driving the entire system unless it is critical.

**E. Control Points:** Control points required for fans and dampers are (as applicable):

1. System start/stop, binary output (BO)
2. Fan status, binary input (BI)
3. Remote static pressure, analog input (AI)
4. Damper end switch (BI) when required to avoid system damage
5. Capacity device modulation, analog output (AO)
6. Differential pressure (local switch) (when required)

#### 7.5.2.2 Fans Controlled by Variable Frequency Drives (with Associated Isolation Dampers)

**A. HOA Control:** See the Variable Frequency Drive (VFD) Component for more requirements relative to drives. An HOA switch shall be provided on the VFD. Any applicable fireman's override shall override any HOA switch function. Otherwise, the HOA shall control the fan as follows:

1. In the hand position, the fan shall start and run continuously at a speed manually set on the drive unless a safety device trips. A mechanism shall be provided to open the dampers when the HOA is in the hand position.

2. In the Off position, the fan shall stop and dampers shut.

**B. BAS Fan Control:** In the auto position, the BAS shall control the fan as indicated below.

1. The drive may have a drive bypass. The bypass position shall be monitored and enunciated as an alarm on the BAS. When the drive is in bypass position, the isolation damper end switches shall be in the safety circuit. That contact shall be shunted when the drive is in the drive position. The application in bypass must include appropriate consideration of the operation in bypass mode such as operating point, ductwork pressurization, and noise. When bypass mode is applied on direct drive fans, fans shall not be allowed to operate above its rated class RPM. Consideration shall be given for adding a backup VFD to operate the direct drive motors in bypass mode. It is required for the backup VFD to meet the harmonic requirements of the primary VFD.
2. The BAS shall control starting and stopping of the fans. Fans shall start at minimum speed and ramp up under a controlled rate to the required capacity. When fans stop, they shall ramp down from control speed to minimum at a controlled rate prior to stopping.
3. The starting and ramp up shall be coordinated with the opening of any isolation dampers when there is a potential for damage or a pressure safety trip. This coordination shall be one of the following:
  - a. **Stand Alone:** Only energize the fan when the damper end switch indicates that the damper is open far enough to not cause physical damage or trip a pressure safety. If at any time during the operation of the fan the damper open indication is lost, the fan shall stop immediately (not under the controlled rate).
  - b. **Headered:** Energize the fan to a preset minimum speed that will not do any damage to the system and equalize the pressure in the common duct. Upon indication that the damper is open far enough not to do

damage, the fan shall be allowed to accelerate to required speed. If at any time during fan operation the damper open status indication is lost, the fan shall decelerate to the preset speed under the control of the drive.

**C. Fan Status:** Fan status shall be monitored via the appropriate type of current switch (either provided separately or within the drive) and the BAS shall prove operation. The BAS shall enunciate a “fan failure” alarm whenever the fan is commanded to run and on status is not proved within an adjustable debounce time. BAS shall enunciate a “hand operation” alarm when the fan is commanded off and status is indicated. In the failure mode, the Run command shall remain except on headered systems for which the Run command shall be removed requiring manual acknowledgment before restart.

**D. Drives Configuration:** Drives configuration shall include the following:

1. Automatic restart on power interruption
2. Acceleration and deceleration rates appropriate to the application
3. On critical applications, the drive shall start into a freewheeling fan and accelerate or decelerate to the required control frequency without stopping or going to a minimum speed first.

**E. Drive Modulation:** The BAS shall modulate the drive in response to the system static pressure.

**F. Speed Feedback:** When the speed feedback does not match the command with an adjustable tolerance for more than an adjustable time delay, the BAS shall alarm a “drive override” alarm.

**G. Minimum Required Points:** Points required for fans and dampers are:

1. System start/stop (BO)
2. Fan status (BI)
3. Pressure sensor (AI)
4. Common drive alarm
5. Drive in bypass (BI)
6. HOA position (BIs)

7. Damper end switch (BI) when required to avoid system damage.
8. Speed control (AO)
9. Speed feedback (AI)

---

## 7.5.3 Variable Frequency Drives

**A. Seamless Integration:** The BAS shall provide for seamless integration with the control of variable frequency drives (VFDs) and associated systems. The interface may be either hardwired (point by point wiring to an applicable terminations on the drives interface board), or through digital communications via a controller network (i.e., a Siemens P1 chip included with the drive or a Modbus interface to the drive), or a combination of both.

**B. Communication Failures:** When the communications option is provided, appropriate protections shall be programmed for communication failures. For instance, if communication is lost from the drive controller, the BAS shall assume the unit has failed and respond accordingly. In such a case, the damper end switches and safeties shall be wired to the drive for safe local operation. If the drive controller loses communication with the unit controller, the drive shall shutdown the fan.

**C. Air System Applications:** For air system applications, all safety indications shall be appropriately wired to facilitate seamless operation. The control system shall in all cases recognize when the drive is operating, even if the drive is in hand operation via the drive panel and execute the programmed sequence of temperature control.

### 7.5.3.1 VFDs in Critical Applications

**A. Critical Areas:** Room pressure critical areas include BSL-3 and any others identified as critical during the planning. The following applies to these areas:

1. Interface between the BAS controller and VFD shall be hard wired directly, point by point from the BAS to the VFD interface board.

2. Interface shall not be done through digital communications except as provided supplementary to the hard-wired interface.

---

## 7.5.4 Pumps

**A. HOA Switch:** A HOA switch shall be provided on either the starter or the VFD. The HOA shall control the pump as follows:

1. In the hand position, the pump shall start and run continuously.
2. In the off position, the pump shall stop.
3. In the auto position, the BAS shall control the pump as indicated below.

**B. BAS Control:** The BAS shall control starting and stopping of the pump. The pump shall start at minimum speed and ramp up under a controlled rate to the required capacity where variable flow is used. When the pump stops, it shall ramp down from control speed to minimum at a controlled rate prior to stopping.

**C. Pump Status:** Status shall be monitored via the appropriate type of current switch (either provided separately or within an associated drive) and the BAS shall prove operation. Status must be valid whether the drive is normal or in bypass. The BAS shall enunciate a “pump failure” alarm whenever the pump is commanded to run and status is not proved within an adjustable debounce time. The BAS shall enunciate a “hand operation” alarm when the pump is commanded off and on status is indicated. In no case shall a loss of status coincident with a loss in power be alarmed as a failure. Drives shall have an automatic restart programmed.

*Rationale: A clear alarm message is required to provide accurate information for operation and trouble-shooting.*

**D. Pump-Capacity Modulation:** Where pump capacity is modulated by a speed drive, the BAS shall modulate the drive in response to the system static pressure sensed at a location(s) remote from the pump. The set point shall be reset based on terminal requirements when practical. Programming shall be in place to avoid one



terminal device driving the entire system unless it is critical. When the speed feedback does not match the command with an adjustable tolerance for more than an adjustable time delay, the BAS shall alarm a “drive override” alarm.

**E. Minimum Required Points:** Points required for pumps are:

1. Pump start/stop (BO)
2. Pump status (BI)

For pumps with VFDs, the additional required points are:

1. Speed control (AO)
2. Speed feedback (AI)
3. Common drive alarm
4. HOA “not in auto”
5. Drive in bypass

## 7.5.5 Coils (in AHUs over 1,500 L/s [3,180 cfm])

**A. Coil Control:** Coils shall be controlled by a modulating valve and include a temperature sensor immediately downstream of the coil before any other coil or heat-transfer element. Coil selection shall be coordinated with the control design and valve selection to ensure stable control particularly at light-loading conditions.

**B. Points Required:** The minimum number of points shall be:

1. Capacity control valve (AO)
2. Leaving air temperature (AI)
3. Entering air temperatures (AI)

**C. Heating and Cooling Coils:** When heating and cooling coils are included in one supply system, programming shall prohibit simultaneous heating and cooling operation (unless required for dehumidification) and smoothly sequence as loading changes.

***Rationale:** Coil control programming shall be coordinated with all other elements that affect temperature of the supply air to minimize the energy use.*

**D. Air Handler Sensors:** Refer to [Section 7.6 Installation](#) for valves and sensor requirements. Sensors within an air handler shall be averaging unless they are after a well-mixed condition like downstream of a fan.

***Rationale:** Air may not be well mixed in a large AHU due to temperature stratification or local airflow distribution, so averaging temperature from multiple points is required. Coordinate with the AHU manufacturer and select the right temperature sensor.*

### 7.5.5.1 Preheat Coils

**A. General:** All preheat coils shall be controlled from the coil leaving temperature (the set point of which shall be dynamically adjusted to coordinate with other loops). Preheat control valves shall be normally open when used for general heating and shall be normally closed when serving systems such as animal facility. Preheat control shall remain active when the unit is de-energized; therefore, it cannot be fed from the same control compressed air that powers the pneumatic damper actuators. In addition to the minimum points required for all coils, preheat coils shall have a low limit temperature sensor.

**B. Steam Preheat Coils:** Steam preheat coils that are the only means of modulating capacity are not recommended; however, if they are used, the steam input shall be controlled by two valves with a 1/3 to 2/3 arrangement. Control valves shall be sized for a pressure drop of 75% of inlet pressure.

**C. Dampers:** Where face and bypass dampers are used, provide at least one valve sized for modulating service above 5°C (41°F). The sequence shall include opening the face damper to full face and modulating the referenced valve above 5°C (41°F) to minimize wipe-off overheating. Below 5°C (41°F), the steam valves shall be full open and the face and bypass dampers shall be modulated for control. Ensure sensors and freeze stats are adequately downstream of the face and bypass dampers to get a good mixed condition.

**D. Glycol Preheat Coils:** Valves shall be sized for good control across the range. Glycol supply temperature to the coil shall be reset with outside air such that the required flow shall stay in the turbulent region on the coil. Alternatively, a coil recirculating pump may be provided that shall maintain flow in the turbulent region at low loads and based on outside air to ensure freeze protection. Coordinate with the AHU manufacturer and select the right temperature sensor.

### 7.5.5.2 Chilled Water Coils

**A. Coil Selection:** Chilled water coil selection shall be coordinated with the control design to ensure smooth operation and stable control at low load, particularly with 100% outdoor air units. If feasible, reset the chilled water temperature to keep the flow in the turbulent region. As this may not be feasible if some units are dedicated to internal zones, provide an alternate means of ensuring adequate flow at low load. Chilled water valves shall fail in a position based on the application:

1. Chilled water valves serving 100% outdoor air units shall fail open.
2. Chilled water valves serving computer rooms or other spaces that primarily need cooling shall fail open.
3. Chilled water valves serving recirculating systems, which in turn serve standard occupied zones shall be normally closed.
4. An automated isolation valve may be required on chilled water supply pipe to coils serving 100% OA units. This prevents flooding the mechanical rooms and the causing major damage to occupied floors below. A/E shall review this requirement with NIH early in the design process.

***Rationale:** All coil performance testing is based on “turbulent” conditions. When the water travels too slowly through the tube, the coil is in a “laminar flow” condition, and generally causes great unpredictability in coil performance as the coil doesn’t operate as designed condition.*

### 7.5.5.3 Reheat Coils

**A. Reheat Coil Valves:** Reheat coil valves shall be sized for smooth and stable control. Reheat valves on reheat coils provided with the supply air handler shall close when the system is off. Actuators on the reheat shall fail in a position as is applicable for the space it serves. For specialty rooms, consult with the researcher as to the potential for harm in either case. Examples are:

1. General space reheat valves shall fail in the last position or open.
2. Animal holding room reheat valves shall fail in the last position or closed (and room shall have high temperature alarm).
3. Computer room reheat valves shall fail closed.

**B. Floating-Type Electric Actuator:** For most terminal applications, a floating-type electric actuator will be acceptable such that timed recalibrations are required. These shall not be permitted in critical applications unless it can be demonstrated that the recalibration will not result in temperature swings beyond the space-temperature tolerance. The following occupancies shall not include floating reheats without approval of the PO and the DTR:

1. Animal holding rooms
2. Containment and high containment laboratories
3. NMR suites
4. EM suites
5. Procedure rooms
6. Isolation rooms
7. Any other application requiring tight temperature tolerances

## 7.5.6 Converters

**A. General:** Steam converters shall be controlled by properly sized steam valves in a 1/3 to 2/3 (or other sufficient turndown ratios determined by the A/E) arrangement. When redundant converters are provided,

provide automatic ability to isolate the redundant converter. Control shall be based on leaving heating water temperature, reset when feasible with systems served as indicated for hydronic systems.

**B. Required Points:** Control points required for a typical converter are (note that return temperatures are required at the system level):

1. Enable (BO) when multiple converters are provided
2. Capacity control (AO) to staged valves
3. Discharge temperature (AI)

**C. Converter:** Steam valves for the converter shall fail closed. In some cases, the converter may be part of scientific equipment and any connection to the BAS shall be at the request of the institute.

---

## 7.5.7 Heat Exchangers: Fluid to Fluid

**A. Properly Sized Valve:** The heat exchanger shall include a modulating control via a properly sized valve and control of heat exchanger shall maintain system supply temperature.

**B. Required Points:** Control points required for a typical heat exchanger are (note that return temperatures are required at the system level):

1. Enable (BO) when multiple heat exchangers are provided and automatic isolation is required
2. Capacity control (AO) to staged valves
3. Discharge temperature (AI)

---

## 7.5.8 Humidifiers

**A. Control:** Humidifiers shall be controlled to maintain the space or exhaust/return duct humidity, and/or a maximum supply duct relative humidity of 85%. As such, the BAS shall include space or exhaust/return duct humidity, supply duct humidity, and capacity control

(coordinated with the designed humidifiers however modulating). All humidifiers shall be provided with high limits sensors and cutout.

**B. Jacketed Humidifiers:** For jacketed humidifiers that keep the dispersion tubes heated, the BAS shall include a two-position isolation valve on the humidifier steam that is opened below an applicable outside air dewpoint temperature and closed above it with an acceptable dead band.

**C. Placing Sensors:** Exercise care in placing sensors and other components downstream of humidifiers to make sure they are well past the absorption distance.

**D. Packaged System:** When the humidifier is a packaged system such as a reboiler, the BAS shall monitor a common alarm. Care shall be taken in applying local packaged reboilers with regards to the continuity of steam pressure during fill cycles.

***Rationale:** Fill cycles with cold water can depress steam pressure in the dispersion header and cause the control loop to wind up resulting in overshoot when the fill cycle stops. This can cause saturation of downstream surfaces and potential tripping of downstream smoke detectors. Coordinate with the mechanical design to ensure this situation is avoided.*

---

## 7.5.9 Exhaust Air Ducts

**A. General:** Sensors in exhaust ducts shall be able to withstand the exhaust environment and be rated for any applicable hazard. Exhaust air ducts shall include the following as appropriate:

1. Exhaust air temperature (AI) only for systems that include general exhaust
2. Exhaust air humidity (AI) when system-level humidity is controlled or the zone requires humidity monitoring
3. Smoke detector (local device) as required by NIH and NFPA
4. Pressure sensors when required by the system

### 7.5.10 Filter Racks (Including Pre-, Final, and HEPA)

**A. Differential Pressure Status:** The BAS shall monitor the differential pressure status of the filter bank. A differential pressure switch shall provide an indication when the differential pressure across each bank of filters exceeds the loaded condition associated with the rated flow on the unit. A differential pressure gauge shall also be mounted in parallel with each switch.

**B. Pressure Sensor:** A pressure sensor (AI) shall be used in lieu of a pressure switch on all HEPA filter banks. Care shall be taken to filter the contaminants in the dirty sensing line to keep the sensor clean. Provisions shall also be made to decontaminate and remove the sensing-line HEPA filter.

### 7.5.11 Exhaust Air Stacks (Contaminated Systems)

The velocity of the exhaust air in exhaust stacks shall be controlled to maintain adequate dispersion and to prevent entrainment in outside-air systems. When systems are constant volume, no monitoring is necessary. When systems are VAV, bypass air is used to maintain the stacks at constant volume, no monitoring is necessary. However, if the minimum velocity is maintained by staging systems or any means where the velocity in the stack varies, airflow velocity sensor shall be provided if the velocity cannot be calculated from measured airflow. Single point sensors positioned and calibrated shall be adequate for this.

### 7.5.12 Heat-Recovery Wheels

**A. BAS Control:** The BAS shall fully control heat-recovery wheels including sensing the temperature of all four air streams around the wheel, and the speed of the wheel via the speed drive furnished with the wheel.

**B. Monitoring, Maintenance, and Mixing:** The BAS shall also monitor the rotation sensor and alarm when rotation is expected and not proven. The heat-recovery sequence shall be coordinated with all other thermal and humidity loops in the air systems. Mechanical design and the controls shall be provided to enable the wheel to be isolated from any air stream for maintenance. Averaging temperature sensors shall be used downstream of the wheel where space is not provided to allow adequate mixing as is typical on the supply side. Adequate mixing distance shall be provided before a single point sensor to ensure thorough mixing.

**C. Sequence Modes:** Heat wheel sequence shall include the following modes:

1. **Winter Mode:** Winter mode shall be specified when the outside-air temperature is below the supply air set point minus 3°C (37.4°F). The speed of the drive shall be modulated to maintain the supply temperature leaving the heat-recovery coil at a set point coordinated with the other loops in the supply system.
2. **Intermediate Mode:** Intermediate Mode mode is used when the outside-air temperature is above the supply air set point and below the return/exhaust air temperature (or enthalpy when desiccant technology and a total energy sequence is employed). In this mode, the wheel shall rotate at a minimum speed.
3. **Summer Mode:** When the outside air temperature (or enthalpy) is above that indicated for the high side of the intermediate range, the wheel shall rotate at maximum speed.
4. **Antifrost:** When the air temperature leaving the exhaust coil falls below 0°C (32°F), the speed of the wheel shall be reduced to maintain that temperature at 0°C.

*Rationale: Careful control strategies are required to operate a heat-recovery wheel and ensure maximum recovery effectiveness of the entire ventilation system.*

## 7.5.13 Variable Air Volume/ Constant Volume Terminals

**A. Components:** The VAV control shall be pressure-independent and shall be fully DDC on secondary controllers.

*Exception: critical applications shall be controlled by primary controllers as indicated below).*

The damper fail position shall apply to the space/component it is serving. Where there are no specific requirements for the fail position, it may be a cost-effective floating (tri-state) actuator that fails in the last position. Commercial electronic actuators shall be provided unless indicated otherwise. Specialty applications are listed below.

**B. Airflow Set Point:** The BAS shall modulate the air valve to maintain the airflow set point. Set point shall depend on the application. Examples are as follows:

1. For temperature control when the primary air is below that required to maintain the room-temperature set point, the airflow set point shall be reset between its minimum and maximum limits as the space temperature rises above the cooling set point. When a zone requires heating, the heating minimum limit shall be as dictated in the design.
2. In constant volume (CV) systems, the airflow set point shall be dictated by the schedule. Occupied and unoccupied set points shall be as dictated in the design.

### 7.5.13.1 Serving Zones with VAV Fume Hoods

**A. Integral with Zone Level:** The control of the terminals shall be integral with the overall zone-tracking logic as indicated under the zone level. Actuators shall be fast acting (full stroke < 2 second) electronic actuators. The fume hood controls shall be required to meet the aggressive control requirements mandated by the NIH/ASHRAE 110 Modified Fume Hood Testing Protocol as described in [Section 6.1.16.4](#). Therefore, consider having the control manufacturer provide the fume hood exhaust terminal.

**B. Fast-Acting Actuators:** Supply- and general-exhaust terminals associated with that zone may be commercial

grade as long as they are fitted with fast-acting actuators and the control contractor accepts responsibility for overall zone performance in writing. Dampers on fume hoods shall fail open.

**C. Monitor/Alarm:** Where airflow is not measured and it is inferred from a valve position as in a venturi valve application, the BAS shall monitor and alarm the condition where the pressure in the duct is inadequate to maintain the correlation.

*Rationale: Coordinate VAV and fume hood control dampers (air valves) to ensure accurate airflow control.*

### 7.5.13.2 Reheat Control Valves

Single-duct boxes require a reheat-coil-valve analog output. This actuator shall be modulating. Either a cost-effective floating actuator that fails in the last position or a normally open or closed valve as dictated by the application and the zone it serves may be used. The A/E shall coordinate with the researcher to determine the best fail-safe position. Examples include:

1. Valves serving animal holding rooms shall fail in the last position or closed.
2. Fly rooms shall fail closed.
3. Valves serving computer rooms shall fail in the last position or closed.
4. Valves serving standard occupied zones that have exterior walls shall fail in the last position or fail open. Those serving interior spaces shall fail in last position or closed.

### 7.5.13.3 Floating Control Damper and Valve Actuators

**A. Non-critical Applications:** Floating control applications shall only be used in non-critical applications. Examples of where floating actuators may be used include:

1. Animal facility reheat valves where it can be shown that they never present a temperature variation that is outside acceptable ranges



2. Offices that are not part of adjacent critical laboratory space-pressure control
  3. Corridors that are not part of adjacent critical laboratory space pressure control
  4. Miscellaneous terminal units serving support spaces like mechanical and electrical rooms
  5. Laboratory airflow and reheat control where hoods are not part of the zone
3. Miscellaneous terminal units serving support spaces like mechanical and electrical rooms

***Rationale:** For the non-critical areas, the automatic recalibration of the airflow pressure sensor can take place during off-hours with a minor and momentary interruption of the HVAC system when stroking the dampers.*

**B.** Examples of where floating actuators shall not be used include:

1. Fume hoods, BSCs, and canopy-hood air-control dampers
2. Animal facility reheat valves (where short-duration temperature swings can impact research)
3. Containment and high containment spaces

***Rationale:** Floating control damper and valve actuators may require periodic stroke recalibration that can cause upsets in pressure balance and short-duration swings in temperature. Floating actuators also require recalibration on restoration of power that can delay returning to a steady state after a power outage.*

#### 7.5.13.4 Recalibration of Airflow Pressure Transducers

**A. Re-Zeroing of Pressure Sensor:** Where pressure sensing in airflow applications requires periodic zeroing of the pressure transducer to maintain its accuracy, VAV terminal boxes serving laboratories shall include devices to allow re-zeroing of the pressure sensor without stroking the dampers. Spaces where these are not required include:

1. Offices that are not part of or adjacent to a laboratory space-pressure control
2. Corridors that are not part of adjacent laboratory space-pressure control

### 7.5.14 Fume Hoods

**A. Flow Monitors:** Fume hoods shall have flow monitors either provided by the control manufacturer (applicable to VAV hoods) or by the hood manufacturer (applicable to constant volume hoods). These monitors shall include indication of safe airflow, suppressible audible and visual alarms, that activate when face velocity is out of range ( $< 80$  fpm or  $> 120$  fpm), and an emergency ventilation switch or button. At a minimum, the BAS shall monitor the alarm condition and the emergency ventilation position and enunciate an alarm on the operator workstation when either condition exists. The BAS shall also initiate any emergency ventilation sequences.

**B. Packaged Control System:** VAV fume hoods shall be controlled by a laboratory-grade packaged control system that can meet the requirements of the NIH Fume Hood Testing Protocol as described in [Section 6.1.16.4 Fume Hoods](#). This shall require a full and stable response to a full sash movement within 3 seconds. The VAV terminal used to control the airflow through the hood is addressed under the VAV Terminals section. The controller for the fume hood shall use sash sensors on the horizontal and or vertical sashes to determine the face area. Adjustments for hood leakage shall be possible. Based on the sash position and leakage, which shall include the airfoil area, the controller shall modulate the damper in the VAV terminal to achieve the calculated airflow.

**C. Independent Hood Monitoring and Alarming:** Any independent hood monitoring and alarming device provided by the institute shall not be tied into the BAS.



## 7.5.15 Ducted Biological Safety Cabinets

**A. Ducted BSC Exhaust:** Ducted BSCs (Type B) shall be exhausted by dedicated exhaust system, which shall be controlled by the BAS. The exhaust flow from the cabinet shall be constant volume and can be controlled by a commercial-grade terminal with a secondary controller unless the BSC is in a critical zone, in which case it shall be controlled by the primary controller that is serving that zone. The cabinet shall be part of a flow-tracking zone. Where ducted BSCs have an isolating damper on the exhaust to allow for decontamination, the closed position of this damper shall be monitored by the BAS. The system and BAS design shall maintain suite pressurization when the BSC is isolated for decontamination. Refer to [Section 6.1.16.3 Biological Safety Cabinets](#).

**B. Interlock Provision:** An interlock must be provided for a type B2 cabinet to shutdown the cabinet fan if there is a loss of building exhaust.

*Rationale: Ducted BSCs have similar requirements to fume hoods as they are part of the flow-tracking system.*

## 7.5.16 Miscellaneous Terminal Units

Fan coil units, unit heaters, etc., shall be fully DDC controlled by application-specific secondary controllers. Sensors indicated for larger units do not apply. Status on fans does not apply. Where terminal units are provided supplementary to the house system, the two systems shall be coordinated to ensure they do not “fight” (heat and cool simultaneously). FCUs with secondary drain pan sensors shall be alarmed to BAS.

## 7.5.17 Active Chilled-Beam Terminal Units

**A. System Type:** The four-pipe (with both reheat water valve and chilled water valve) active chilled beam terminal units are typically used in lab spaces to provide accurate temperature control. The two-pipe active chilled beam (cooling only) could be used for supplemental cooling spaces. Chilled beams only provide sensible cooling to the space. The latent load is handled by a dedicated outside-air system. Chilled beam is not recommended for the spaces with high latent loads, high ceiling height, spaces exposed to humid conditions, or spaces that require large quantities of unconditioned outside air.

**B. Four-Pipe Chilled Beam:** The following control requirements are used for the four-pipe active chilled beam in the lab:

1. Each active, four-pipe chilled beam unit shall be provided with induction air connection, cooling coil section, and reheat coil section. Total space cooling load will be met by the supply air and the terminal cooling capacity provided by the chilled beam coil. Temperature control for each space will be provided by modulating the two-way control valves in the chilled beam cooling coils and reheat coils in sequence.
2. Under the normal mode, the reheat coil control valve and the chilled water coil control valve serving the chilled beam unit modulate to respond to the temperature change in the space.
3. On a rise in space temperature above set point in the space, the reheat coil control valve serving the chilled beam unit will modulate closed and the chilled water coil control valve serving the chilled beam unit will modulate open. On a drop in space temperature below set point in the space, the chilled water coil control valve serving the chilled beam unit will modulate closed and the reheat coil control valve serving the chilled beam unit will modulate open.

4. Actuators on supply and exhaust air terminal units shall modulate between scheduled maximum and minimum supply and exhaust air volumes to each pressure control zone, thus maintaining tracking differential and directional airflow control.
5. During the emergency or distress mode operation, the chilled beam air supply duct branch-isolation damper shall be closed automatically, and the reheat coil control valve and the chilled water coil control valve serving the chilled beam unit modulate to respond to the temperature change in the space. Actuators on supply and exhaust air terminal units shall modulate to maintain emergency mode (distress mode) supply and exhaust air volumes to each pressure control zone, thus maintaining tracking differential and directional airflow control. The A/E shall coordinate with the end user to determine the emergency-mode airflow (e.g., half of the normal operating airflow).
6. Because a chilled-beam cannot remove latent load, the A/E shall provide an instrumentation and control strategy to avoid condensation in two stages:
  - a. Chilled-beam water-temperature control based on room air dewpoint calculation for critical locations
  - b. Locally in the room, using condensate detection to shut the chilled water valve

**C. Humidity/Condensation:** A relative humidity sensor shall be provided, and the BAS shall calculate space dewpoint temperature based on measure space temperature and relative humidity. The chilled beam supply water temperature must be actively maintained to at least 1°C (2°F) to 1.7°C (4°F) above the room air dewpoint temperature. Each temperature control zone shall be provided with a condensation sensor. Upon sensing condensation, the BAS shall close the chilled water control valve to chilled beams in the room and generate a critical alarm.

**D. Chilled Beam Insulation/Installation:** Chilled beam insulation and installation details, specification, and sequence of operation are required for review.

---

## 7.5.18 Glycol Run Around Heat Recovery Coils

**E.** BAS shall fully control the glycol heat recovery coil system. BAS shall control start/stop of the circulating pump and monitor status of the pump and alarm upon failure. In addition, the BAS shall monitor temperature the air stream on the exhaust coils.

# Section 7.6

## Installation

---

### Contents

- 7.6.0 Introduction
- 7.6.1 System Controller Configuration: General Requirements
  - 7.6.1.1 Primary Controllers
  - 7.6.1.2 Secondary Controllers
  - 7.6.1.3 Wire Lines
  - 7.6.1.4 Power to Controllers
- 7.6.2 Temperature Sensors
  - 7.6.2.1 Temperature Transmitters
- 7.6.3 Humidity Sensors
- 7.6.4 Pressure Sensors
  - 7.6.4.1 Air Static and Velocity Transmitters
  - 7.6.4.2 Liquid Differential Pressure Transmitters
- 7.6.5 Flow Sensors
  - 7.6.5.1 Current Switches
  - 7.6.5.2 Control Valves
  - 7.6.5.3 Control Dampers
  - 7.6.5.4 Actuators
  - 7.6.5.5 CO<sub>2</sub> Sensors
- 7.6.6 Compressed Air Systems
- 7.6.7 Control Tubing
- 7.6.8 Control Wiring
- 7.6.9 Wall Penetrations
- 7.6.10 Protection from Transients
- 7.6.11 Software and Software Set-Up Requirements
- 7.6.12 Operator Workstations Hardware
- 7.6.13 Commissioning

## 7.6.0 Introduction

This section defines requirements for the controllers, sensors, computers, software, and the components that make up the system and the means and methods in which they are installed.

### 7.6.1 System Controller Configuration: General Requirements

**A. Overview:** The control system shall consist of primary controllers (which may include expander boards or remote point modules) and secondary controllers, which may include universal programmable controllers and terminal controllers. Each controller shall be located in the vicinity of the equipment or spaces monitored and controlled by the BAS, and communicate with the operator workstations and central servers as indicated under the BAS infrastructure. The following is an overview of the controller terminology.

**B. Primary Controller:** The primary controller is a high powered flexible, programmable controller that communicates on a peer-to-peer local area network (LAN) with other primary controller and operator workstations. It has a real-time clock and high analog to digital (A/D) precision and significant memory requirement. In some cases, it will supervise the communications between the secondary controllers (universal programmable controllers and the terminal controllers) on a sub-LAN.

**C. Secondary Controllers:** The following secondary controllers are connected to a secondary control LAN:

1. **Universal Programmable Controller:** This is similar to the primary controller, but it may reside on a polling sub-LAN. It is fully programmable, but it is usually more restricted as to the point capacity and memory.
2. **Terminal Controller:** This is an application specific controller that is cost-effective for small, standard control sequences as is typical for a variable air volume (VAV) box or fan coil unit.

**D. Controllers and Control Functions:** The intent in identifying these categories of controllers is so that control functions can be provided by a controller of that type. It is the A/E's responsibility to assign control functions to these controller categories according to the DRM and in consultation with ORF where specific direction is not provided.

*Rationale: High-end controllers are more robust, reliable, and flexible, and can handle more trending, but cost more. Where the cost is not justified for a non-critical application, control functions can be provided by the cheaper controllers. Stand-alone functionality is another critical issue that the A/E shall dictate.*

**E. Loss of Communication:** It shall be made clear what control functions must be provided if a controller loses all communication.

**F. Stand-Alone Functionality:** Various degrees of stand-alone functionality shall be specified for each system as the project budget dictates. Controllers shall be provided so that all points associated with and common to one system shall reside within a single controller.

**G. The Processor:** The boundaries of a stand-alone system shall be dictated in the contract documents. Stand-alone functionality requirements are made with reference to the processor. Where stand-alone functions are required, one processor shall execute all the related input/output (I/O) control logic via one operating system that uses a common programming and configuration tool. This shall not be violated without specific approval of the project officer (PO).

*Rationale: This functional intent is to allow cost-effective application of manufacturers' standard products while maintaining the integrity and reliability of the control functions commensurate with their application.*

#### 7.6.1.1 Primary Controllers

**A. Components:** A primary controller shall contain a microprocessor, memory, real-time clock, communication interface, digital and analog I/O, controls, indicators, and power supply. The primary controller shall

communicate with other primary controllers over a primary controller LAN that is high speed and peer to peer. They shall also communicate with the central servers and operator workstations that provides a mechanism for operator interaction, global parameter updates, and information requests and accepts information for alarm reporting, logging of events, generation of reports, and display. The primary controller shall function in an independent mode performing the monitoring and control routines using applications software programs and operating parameters stored in the primary controller's memory.

**B. Capabilities:** The primary controller's capabilities shall include control of all physical parameters such as space temperature, space humidity, and supply-water temperature without requiring data or operating parameters from the central server, workstation, or other controller.

**C. Stand-Alone Functionality:** Primary controllers shall be capable of operating independently in stand-alone fashion with no communication to other devices on the network. All points and functions that make up a functional system (shown on one control schematic) shall be included in one controller to qualify for this stand-alone functionality. Where control sequences depend on global variables such as outside air temperature, the panel shall have the capability of either using the last value or a default value.

**D. Point Groupings:** The A/E shall specifically indicate point groupings for stand-alone capability. Examples of required functional point groupings are:

1. All points and functions required to control an air handler with all directly associated supply, return, and exhaust fans. This excludes the terminals that may be associated with that air handler. Values that may be received across the network include:
  - a. Outside air temperature and humidity sensors
  - b. Emergency power-source indication except in critical applications
  - c. Terminal-based-reset parameters
  - d. Emergency power source indication

e. Terminal-based-reset parameters

2. All points associated with the supply side of a hydronic system: pumps, flow meters, temperature and pressure sensors, proof indications, valves, etc. This excludes the terminals on that hydronic system.
3. All points and functions required to control one terminal system including dampers, valves, flow meters, temperature and humidity sensors, etc. This does not include the scheduling period or any outside conditions that may be necessary for control.

*Exception: Where a variable speed drive is part of the controlled function, when approved, the drive may include a separate field-panel controller. All aspects of failure and loss of communication shall be considered, enumerated in the sequence, and thoroughly tested.*

**E. Memory:** The primary controller shall include sufficient memory to contain the operating system, applications software, the database, control sequences for all required operation, and all required trending when trending is buffered in the controller. Where control-system operation is hindered by a shortage of memory, the contractor shall at no cost to NIH either upgrade the memory or provide multiple controllers.

**F. Ethernet Communication:** Primary controllers shall communicate with other primary controllers and operator workstations via Ethernet.

**G. Converter Precision:** Primary controllers shall provide an input A/D converter precision of at least 12 bit.

**H. Resumption of Power:** Resumption of power after an outage shall cause the primary controller to automatically restart and establish communications with the central server. If the primary controller is unable to establish communications, it shall still perform all required functions while saving certain data for later uplink to the central server. Primary controller shut-down based on a self-diagnosed failure in the power supply, hardware, or software shall set each piece of controlled equipment to a predetermined failure mode.

**I. Uninterruptible Power System:** Controllers shall be powered from the most reliable source that powers any of the systems it serves. In the situation where the

primary controller shall be required to continuously collect data to be transmitted to the workstation, or where it monitors critical recovery information such as the presence of emergency power, it may be necessary to provide an uninterruptible power system (UPS) for the entire primary controller as well as any sensor and controller power required. Where panels are provided with a different power source as the equipment (such as when the panel is on a UPS), the panel shall be provided with a means of monitoring the power source to the controlled equipment. This can be a dedicated monitor as an input or an input coming from transfer switch contacts.

**J. Status Indicator:** Binary Output (BO) points on primary motor controllers, critical valves or dampers shall be provided with hands-off auto (HOA) functionality. Where the controlled device is not provided with a separate status indicator, an input shall be provided to monitor the hand position. Where the hand condition is determined through an independent status monitor such as a fan or pump with a current switch or a valve or damper with an end switch, this input is not required.

**K. Remote Point Modules:** Remote point modules serve as I/O devices for primary controllers and functionally are an extension of the primary controller. Remote point modules transmit their data to the primary controller over a data transmission circuit. This communications circuit shall not be shared with secondary controllers. Failure of a remote point module shall set each piece of controlled equipment to a predetermined failure mode. Remote point modules shall have a UPS where their associated primary controllers also require a UPS.

**L. Built-Up Primary Controllers:** Where a manufacturer's product line does not include a primary controller, they may meet the intent of the primary controller requirement by packaging a network communications controller module with a universal programmable controller (UPC). This "controller secondary LAN" shall be dedicated to the functions directly required by the primary controller and the UPCs shall not compete with any other traffic on the secondary LAN than what is required for the controller operations. One programming language shall be used for all sequencing.

### 7.6.1.2 Secondary Controllers

**A. Universal Programmable Controllers:** UPCs shall be field programmable stand-alone controllers with flexible I/O configuration. The UPC will contain a 7 day calendar and a real-time clock so that its scheduled operations are maintained independent of communication with the primary controller or network communication control module. Because of the potential cost benefits of UPCs, the A/E shall consider their use in less critical applications than would require a primary controller. UPCs may obtain secondary control variables (such as set-point resets, outside-air temperature, emergency power status) from a primary controller, network communications controller module, or other UPC. In the event of loss of communication, the UPC shall control to either the last known network variable or to a set default condition defined at configuration. UPCs shall have A/D conversion of at least 10 bit.

**B. Input:** BO points controlling motors or critical valves or dampers shall be provided with HOA functionality. Where BO function is not provided with a separate status indicator, an input shall be provided to monitor the hand position. Where the hand condition is determined through an independent status monitor such as a fan or pump with a current switch or a valve or damper with an end switch, this input is not required.

**C. Terminal Controllers:** Terminal controllers are application-specific controllers with a fixed complement of I/O functions and fixed (or minimally configurable) applications programs. Their program will accommodate specific operating requirements of utility system equipment by the selection of a small number of set points and operating parameters.

**D. Controller Input/Output:** Electronic circuits shall enable the BAS controllers to interface with the system I/O devices. The BAS controller shall directly support analog, binary, and pulse accumulator electrical input signals as well as analog and binary electric and pneumatic output control signals. Analog data to and from building systems shall be conditioned to ensure signal level and type compatibility.

### 7.6.1.3 Wire Lines

**A. Wiring:** Use physical media for controller to controller or controller to I/O device communications. Wiring shall be twisted pairs that consist of two solid copper



insulated conductors twisted and shielded together to minimize interference by unwanted signals.

**B. Twisted Shielded Pairs:** Select twisted shielded pairs to carry information with highest speed possible depending on the in-place characteristics of the existing field panel or field equipment communications. Select twisted shield pairs to obtain the highest field equipment communications.

**C. Control Wiring:** Control wiring shall be run to avoid electromagnetic interference from other equipment. Control wiring shall be run in its own raceway. Control wiring shall not be run through a variable frequency drive (VFD) cabinet.

#### 7.6.1.4 Power to Controllers

**A. Reliable Power Source:** At a minimum, power to controllers shall be the most reliable source that powers equipment controlled by that controller. For instance, if the controller serves a fan that is on emergency power, the controller shall at least be fed from an emergency circuit. On critical applications, controllers shall be powered from the UPS to maintain continuous operation throughout power outages and transfers. Where the controller power is a different source than that which feeds the equipment, then some form of monitoring shall be provided to inform the controller of the state of the power to the served equipment. For instance, three-phase monitors may be used as inputs to the controller. Positions of transfer switches may also be monitored.

**B. Critical Applications:** In critical applications, where power transfers from emergency power back to normal power shall result in open transitions that may cause controls or equipment to stop or fail, consider requiring the BAS to monitor the point that indicates that a transfer is imminent so that the controller can execute a controlled stop and restart.

### 7.6.2 Temperature Sensors

**A. Sensor Range:** When matched with the A/D converter of the controller, the sensor range shall provide a resolution of no worse than 0.17°C (0.29°F) (unless noted otherwise). Where thermistors are used, the stability shall be better than 0.15°C (0.27°F) over 5 years.

More precise instrumentation may be necessary for specific applications where higher temperature or humidity tolerances and resolutions are required.

**B. Matched Sensor Pairs:** Matched sensor pairs are tested by the manufacturer and certified to indicate within 0.5°C (1°F). The following applications shall require matched sensor pairs:

- 1. Building Loop Connections:** Provide matched loop and building-supply sensors where control sequence requires controlling to a temperature rise.
- 2. Hydronic Temperature-Difference Calculations:** Provide matched-supply and return-temperature sensors where the pair is used for calculating temperature difference for use in load calculations or sequencing.

**C. Room-Temperature Sensors:** A room-temperature sensor shall be an element contained within a ventilated cover, suitable for wall mounting. Provide an insulated base. The following sensing elements are acceptable:

- The sensing element shall be a platinum resistant temperature device (RTD), thermistor, or integrated circuit,  $\pm 0.5^\circ\text{C}$  ( $\pm 1^\circ\text{F}$ ) accuracy at the calibration point.
- Provide set-point adjustment where approved by the PO. The set-point adjustment shall be a warmer/cooler indication that shall be scalable via the direct digital control (DDC) system.
- Provide an occupancy override button on the room-sensor enclosure where occupied/unoccupied sequences are used. This shall be a momentary contact closure.

**D. Multiple Thermal Zones:** When one temperature sensor is used to control multiple thermal zones intended for occupancy by different people in the various zones, sensors shall not have space-temperature adjustment.

**E. Single Point Duct Temperature Sensors:** These shall consist of a sensing element, a junction box for wiring connections, and a gasket to prevent air leakage or vibration noise. The temperature range as required for resolution is indicated as above. The sensor probe shall be type 316 stainless steel.

1. The sensing element shall be a platinum RTD, thermistor, or integrated circuit,  $\pm 0.12^{\circ}\text{C}$  ( $\pm 0.22^{\circ}\text{F}$ ) accuracy at the calibration point.

**F. Low-Limit Duct Temperature Sensors (Freeze Stats):** Low-limit preheat temperature sensor consist of low-limit element, junction box for wiring connections, and a gasket to prevent leakage or vibration noise. The sensing element shall be one linear meter for each one square meter of coil face area. The sensor shall read the lowest temperature on any 0.3 m (1 ft.) section of sensing element. The sensing element shall be evenly placed in serpentine configuration on the downstream side of the preheat coil between coil and next heat transfer component.

**G. Averaging Duct Temperature Sensors:** These shall consist of an averaging element, a junction box for wiring connections, and a gasket to prevent air leakage. Provide sensor lengths and quantities to result in one linear meter (3.28 linear ft.) of sensing element for each 3 square meters (32 ft.<sup>2</sup>) of coil/duct face area. The temperature range as required for resolution is as indicated above.

1. The sensing element shall be a platinum RTD,  $\pm 0.12^{\circ}\text{C}$  ( $\pm 0.22^{\circ}\text{F}$ ) accuracy at the calibration point.

**H. Liquid Immersion Pipe Temperature Sensors:** These shall include a brass or stainless steel thermowell, a sensor, and connection head for wiring connections:

1. The sensing element (chilled water) shall be a platinum RTD  $\pm 0.2^{\circ}\text{C}$  ( $\pm 0.36^{\circ}\text{F}$ ) accuracy at calibration point. Temperature range shall be as required for resolution of  $\pm 0.15^{\circ}\text{C}$  ( $\pm 0.27^{\circ}\text{F}$ ).
2. The sensing element (other systems) shall be a platinum RTD, thermistor, or integrated circuit,  $\pm 0.23^{\circ}\text{C}$  ( $\pm 0.41^{\circ}\text{F}$ ) accuracy at the calibration point. The temperature range shall be as required for a resolution of  $0.17^{\circ}\text{C}$  ( $0.31^{\circ}\text{F}$ ).

**I. Pipe Surface-Temperature Sensors:** These shall include metal junction box and clamps and shall be suitable for sensing pipe-surface temperature and installation under insulation. Provide thermally conductive paste at pipe contact point. The temperature range shall be as required for resolution as indicated above. These shall not be used without specific permission of the PO.

1. The sensing element shall be a platinum RTD, thermistor, or integrated circuit,  $\pm 0.23^{\circ}\text{C}$  ( $\pm 0.41^{\circ}\text{F}$ ) accuracy at calibration point.

**J. Outside-Air-Temperature Sensors:** These shall consist of a sensor, sun shield, utility box, and a water-tight gasket to prevent water seepage. The temperature range shall be as required for resolution as indicated above.

1. The sensing element shall be a platinum RTD, thermistor, or integrated circuit,  $\pm 0.23^{\circ}\text{C}$  ( $\pm 0.41^{\circ}\text{F}$ ) accuracy at the calibration point.

### 7.6.2.1 Temperature Transmitters

Where required by the controller, the sensors as specified above may be matched with transmitters outputting 4–20 mA linearly across the specified temperature range. Transmitters shall have zero and span adjustments, an accuracy of  $0.06^{\circ}\text{C}$  ( $0.11^{\circ}\text{F}$ ) when applied to the sensor range.

## 7.6.3 Humidity Sensors

Unit shall produce linear continuous output of 4–20 mA for percent relative humidity (% RH). Sensors shall have the following minimum performance and application criteria:

1. Input Range: 0–100% RH
2. Accuracy (% RH):  $\pm 2\%$  (when used for enthalpy calculation, dewpoint calculation or humidifier control) or  $\pm 3\%$  (monitoring only) between 20–90% RH at  $25^{\circ}\text{C}$  ( $77^{\circ}\text{F}$ ), including hysteresis, linearity, and repeatability
3. Sensor Operating Range: As required by application
4. Long-Term Stability: Less than 1% drifts per year

## 7.6.4 Pressure Sensors

Pressure sensors shall be provided with a range commensurate with the application. Accuracy shall be specified to be commensurate with the requirement.

### 7.6.4.1 Air Static and Velocity Transmitters

**A. Applications:** Transmitters include static pressure or differential static pressure and velocity pressure. Provide the smallest range feasible for the application. Auto-zero modules shall be used on air-flow transmitters to periodically re-zero the transmitter. Zero and span adjustments' accuracy shall be  $\pm 1\%$  of full scale for static and 0.25% for air velocity.

### 7.6.4.2 Liquid Differential Pressure Transmitters

Pressure transmitters shall gauge pressure in the form of a linear 4–20 mA signal. All components shall be hermetically sealed in a type 316 stainless steel case. Provide a wall-mounted 5 valve cabinet for mounting the transmitter. Pressure transmitters shall meet the following performance criteria:

1. 0.5% accuracy over the entire span
2. Repeatability:  $\pm 0.1\%$  at maximum span
3. Stability:  $\pm 0.25\%$  of upper range for a period of 6 months

## 7.6.5 Flow Sensors

Flow sensors shall be carefully placed to ensure flow profiles that are required for accurate flow sensing. Designs shall specifically indicate the location of the sensors and indicate the length of unobstructed duct or pipe. For flow meters, temperature and pressure sensors, all manufacturers requirements for piping free run (required upstream and downstream diameters), distance from obstructions, devices or valves, and piping geometry requirements (i.e., elbows in/out of plane) shall be carefully considered. Strict attention shall also be paid to minimum and maximum velocity requirements. Piping-size reductions in metering section may be required to maintain reasonable minimum velocities for majority of annual conditions. Refer to [Section 6.3](#) for additional requirements on flow meters.

**A. Water and Steam Less than 2:1 Turndown:** Use an in-line venturi flow meter with a differential pressure transmitter as specified above. Differential pressure may

be linearized in the transmitter or by the BAS. Accuracy in a properly located meter shall be better than 5%.

**B. Water and Steam Greater than 2:1 Turndown:** Provide either a turbine flow meter, vortex shedding meter, magnetic meter or, when measuring water, an ultrasonic flow meter.

1. **Turbine Flow Meter:** Turbine flow meters may be used for measuring flow of chilled water and steam with a high turn down ratio unless prohibited by pipe size. The turbine flow meters shall be installed so that they may be immersed and removed for maintenance and calibration without disrupting flow. "Hot tap" methods shall be used to install turbine flow meters in existing line under pressure. Accuracy in a properly located meter shall be better than 5%.
2. **Ultrasonic Flow Meter:** Ultrasonic flow meters may be used for measuring flow of water systems with a high turn down ratio. Accuracy in a properly located meter shall be better than 5%.
3. **Vortex Shedding Flow Meter:** Vortex shedding flow meters may be used for measuring flow of steam systems with a high turn down ratio. Accuracy in a properly located meter shall be better than 5%.
4. **Magnetic Flow Meter:** Magnetic flow meters may be used for measuring flow of water or steam systems with a high turn-down ratio. Accuracy in a properly located meter shall be better than 5%.

**C. Air Flow Greater Than 5 m/s (1000 cfm):** Use a Pitot tube averaging grid of a material compatible with the environment. The use of fan inlet grids are preferable where possible to measure fan flow. Fan inlet grids shall be provided by fan manufacturer and shall not block or affect fan efficiency. The transducer shall have an accuracy of  $\pm 0.25\%$  and stability of  $\pm 0.5\%$  of full scale per year.

**D. Air Flow Less Than 5 m/s (1000 cfm):** Use hot-wire anemometer grid or vortex-shedding grid stations rated for the environment they are applied in. Both types shall have sensing elements distributed throughout the cross section of the duct. If used in outside air ducts, ensure the sensor element is rated for the conditions of its duty.

### 7.6.5.1 Current Switches

**A. For Constant Speed Motors:** Current switches shall be provided for status indication of constant speed motors. Switch shall indicate loss of status when current falls below an adjustable trip point. Current switches shall include light-emitting diode (LED) indication of status.

**B. Variable Speed Motors:** Current switches shall be provided for status indication of variable speed motors. In applications where minimum operating amp draw is less than no load motor amp draw at 60 Hz, switch shall be self-calibrating based on VA memory associated with frequency. This shall form a curve to determine the trip point based on speed such that it shall detect a belt break with subsequent increase of control output to 60 Hz. Current switches shall include LED indication of status. In a critical application, proof or loss of proof shall consistently indicate within 10 seconds of event.

### 7.6.5.2 Control Valves

**A. General:** Valves shall be applicable for the rated pressure and temperature service. Close-off pressures, determined in concert with the actuators and valves shall be specified to close off against extreme anticipated conditions. Valves shall be selected such that they are not oversized.

**B. Modulating Valves:** Modulating valves shall be carefully selected to control in a smooth and stable fashion across the range of anticipated conditions. General requirements are indicated below.

**C. Flow Characteristic Analyses:** Flow characteristic analyses shall be submitted when the selection criteria indicated below does not match with the correlation between stroke and flow.

**D. Valves:** All valves over 25 mm (1 in.) shall have a position indicator. The BAS output to modulating valves shall be analog with the following exceptions:

1. Terminal reheat valves may be floating or pulse-width-modulated (PWM) when not serving critical spaces.
2. Fan coil and unit heater and similar terminal device valves may be floating or PWM.

**E. Steam Control Valves:** Steam control valves shall be cage-guided globe or plug valves with a linear or equal percentage characteristic. Modulating valves shall be sized for in excess of 75% of the rated steam supply temperature. Fail positions shall be as follows:

1. **Primary Heating:** As dictated for occupancy or application but normally open as a default
2. **Clean Steam:** Normally closed
3. **Humidifiers:** Normally closed

**F. Water Valves:** Modulating water valves may be globe, ball, or butterfly valves with an equal percentage or linear characteristic (building chilled water valve controlling flow from the loop which shall be linear). A modulating water valve shall be sized for greater than 50% of the controlled circuit pressure drop. Refer to [Chapter 6](#) for high-performance type control valves for chilled water and electron microscope applications. Fail positions shall be as follows:

1. **Primary Heating:** As dictated for occupancy or application but normally open as a default
2. **Primary Cooling:** Normally open serving a 100% outdoor air units and or cooling only applications. Otherwise, they shall be normally closed.
3. **Building Chilled Water Valve:** Normally open
4. **Terminal Reheat:** Last position or as dictated by the zone served

**G. Water Pressure-Independent:** Modulating water valves may be pressure-independent such that they maintain a given flow at a given stroke within required pressure range. The valves shall require no maintenance and shall not include replaceable cartridges. Flow accuracy shall be +/- 5% due to system pressure fluctuations. Pressure-independent valves are not preferred.

### 7.6.5.3 Control Dampers

**A. General:** Dampers shall be applicable for the rated pressure and velocity service. Damper structural rating shall exceed extreme anticipated conditions like fan dead head. Modulating dampers shall be carefully selected to control in a smooth and stable fashion across the range of anticipated conditions, except where associated

with a mixed-air sections, used for promoting mixing, and where sizes dictate single blade. Dampers shall be opposed blade.

**B. Outside Air-Control:** Outside air-control dampers shall be low leakage dampers with damper seals.

**C. Analog Output:** Output to modulating control dampers shall be analog with the following exceptions:

1. Terminal reheat valves may be floating or PWM when not serving critical spaces.
2. Fan coil and unit heater and similar terminal device valves may be floating or PWM.

**D. Standard VAV Terminal Dampers:** Standard VAV terminal dampers may be floating or PWM when not serving critical applications.

#### 7.6.5.4 Actuators

**A. General:** Size actuators and linkages to operate their appropriate dampers or valves with sufficient reserve torque or force to provide smooth modulating action or two-position action and adequate close-off rating as required. For actuator used on chilled water bridge control return valves, refer to the requirements in [Chapter 6](#). Actuators shall be electronic unless there is a compelling case for pneumatic. High torque damper actuators used for containment applications shall be pneumatic.

**B. Standard Electronic Actuators:** Standard Electronic Actuators shall be designed for a minimum of 60,000 full cycles at full torque and be UL-873 listed. Provide a stroke indicator. Actuators shall have positive positioning circuit and selectable inputs. Full stroke shall be within 90 seconds. Where fail positions are required, provide spring return on the valve with adequate close-off force.

**C. Fast-Acting Electronic Actuators:** Provide fast-acting electronic actuators for VAV terminals on the fume hood and associated tracking-zone dampers. Also, provide fast-acting actuators on all critical applications such as containment laboratories. These actuators shall move full stroke in less than 2 seconds.

**D. Pneumatic Actuators:** Provide heavy-duty actuators with stroke indication and spring return. When so indicated and where more than two actuators are to be operated in sequence with each other, provide position feedback-positive positioners with adjustable start point

and operating range. Additionally, provide positive positioners on all modulating pneumatic valves larger than 50 mm (2 in.) and as shown on drawings.

#### 7.6.5.5 CO<sub>2</sub> Sensors

CO<sub>2</sub> sensors shall be provided for demand control ventilation of high density occupancy spaces such as auditoriums, classrooms, lecture halls and conference rooms.

### 7.6.6 Compressed Air Systems

**A. General:** Where compressed air systems are used, they shall meet the following requirements. Note that compressed-air applications for controls shall be limited to special cases where very large torque is required.

**B. The Oil-Free/Size:** The air compressor shall be oil free. Use duplex-air compressors sized for less than one-third duty cycle. Size storage is to prohibit more than six starts an hour on any compressor.

**C. Backup:** Where the building system is a backup to the campus system, connect the new systems as a backup to the plant air and to provide control air when the plant air pressure drops below the needed pressure.

**D. Air Dryers/Filtration:** Air drying and filtration in buildings shall be provided when only plant air is being used. The instrumentation air supply shall have an air dryer, a refrigerated dryer will suffice. When continuous air consumption is required on a device or through a pipe that is exposed to outside conditions, a desiccant dryer shall be provided. Filtration shall be provided before and after the air dryer. Air filters shall be installed with bypass and isolation valves to permit filter replacement without instrument air supply disruption.

**E. Compressed Air:** Compressed air shall be distributed at high pressure with zoned pressure-reducing stations.

**F. Critical Controls:** Where the controls are serving critical facilities, an alternate source of compressed air shall be provided. A campus air source and a local installation shall meet this requirement. A control air skid backed up by a laboratory air compressor shall also meet this requirement.



**G. Control Air under High Pressure:** Control air shall be pressurized to a high pressure for supply and storage. This pressure shall be adequate to meet the requirements of the system. Pressure-reducing stations shall then be provided to reduce and trim the pressure to a consistent pressure. Pressure-reducing valve (PRV) stations shall include redundant PRVs and a manual bypass. Each compressed air supply shall include a filter dryer, which again shall be redundant to allow uninterrupted operation.

---

## 7.6.7 Control Tubing

**A. Type L Copper Tubing:** All copper tubing in mechanical equipment rooms shall be hard-drawn Type L copper.

**B. Non-Plenum Return Ceilings:** All tubing installed above non-plenum return lift-out ceilings shall be Type FR self-extinguishing polyethylene.

**C. Plenum Return Ceilings:** All tubing installed in plenum return ceilings shall be soft copper Type L.

**D. Vertical Chases:** All control tubing installed in vertical chases shall be hard copper. Drip legs on vertical risers and shut-off valves shall be located in an accessible location where the main leaves the riser.

**E. Non-Accessible Walls or Ceilings:** All control tubing installed in non-accessible walls or ceilings shall be soft copper.

**F. Outdoor/Indoor Tubing:** All control tubing installed outside shall be jacketed hard copper for single lines and sheathed polyethylene for multiple lines. All lines outdoors shall be heat traced.

**G. Control Panels:** All tubing in control panels shall be Type FR polyethylene.

**H. Air Hangers:** All control air hangers shall be clamp type and shall not be attached to other trades.

**I. Sweated Fittings:** All connections shall be sweated fittings.

**J. Line Installation:** All air lines shall be installed in straight lines in conjunction with building construction. No control lines shall be run exposed in occupied spaces.

## 7.6.8 Control Wiring

**A. Electrical Metal Tubing:** All control wiring in mechanical equipment rooms or other spaces in which it is readily accessible shall be installed in electrical metal tubing (EMT) with compression fittings.

**B. Interstitial Spaces:** All control wiring run in interstitial spaces shall either be run in EMT with compression fittings or a cable tray or raceway.

**C. Rigid Conduit:** All control wiring installed outdoors or any area subject to moisture shall be installed in rigid conduit.

**D. Vertical Chases:** All control wiring installed in vertical chases shall be installed in EMT with compression fittings.

**E. Non-Accessible Ceilings:** All control wiring above non-accessible ceilings shall be installed in EMT with compression fittings.

**F. Non-Lab/ARF Accessible Ceiling Spaces:** All control wiring installed above accessible ceiling spaces that are not located above laboratories or animal holding areas shall be plenum type, not installed in conduit, but neatly run with generous use of rings or ties.

**G. Control Functions/Wire Color:** Similar control functions shall have a similar wire color.

**H. Controller to the Sensor:** Wire shall not be spliced from the controller to the sensor.

**I. Terminal Strips:** All terminations shall be on terminal strips.

**J. Raceways/Junction Boxes Color Code:** Color code all raceways and junction boxes with color directed by the design engineering group.

**K. Separate Control from Power Wiring:** Control wiring shall not be routed in the same raceway as power wiring.

---

## 7.6.9 Wall Penetrations

Wall penetrations for the BAS shall be prepared and sleeved. Wall penetrations through fire-rated walls should be avoided. Where necessary, penetrations shall



be in accordance with NFPA and NIH regulations. All fire-rated features of the contract design must be approved by the Division of the Fire Marshal (DFM).

## 7.6.10 Protection from Transients

The BAS electrical power supply, data transmission system, and input/output functions shall be protected against electrical load transients.

## 7.6.11 Software and Software Set-Up Requirements

**A. Controllers:** Controllers shall be provided with a real-time operating system resident in read-only memory (ROM). This software shall execute independently from any other devices in the system. It shall support all specified functions. It shall provide a command prioritization scheme to allow functional override of control functions. At a minimum, the following shall be provided:

1. Real-time operating system software
2. Real-time clock/calendar and network time synchronization (except terminal controllers)
3. CPU diagnostic software
4. LAN communication software
5. DDC software
6. Alarm processing and buffering software
7. Energy-management software
8. Data trending, reporting, and buffering software
9. I/O (physical and virtual) database. Inputs and outputs shall have the capability to be overridden for emergency modes and testing. If the design documentation does not specifically indicate the required I/O points, the control vendor shall request in writing which I/O points shall

have this capability. If they do not request this in writing, they shall reprogram or reconfigure the systems as required during testing.

### 10. Remote communication software

**B. Password Protection:** The BAS software shall provide for restricted access to the system parameters based on user rights assigned by the administrator. The control vendor shall coordinate with maintenance staff for assignment. Each new facility shall include at least 10 new user set-ups with rights customized as dictated by maintenance staff. Where the project incorporates a balancing contractor and or commissioning agent, the control vendor shall provide them with appropriate passwords.

1. Password protection shall be granular with the capability to provide rights by group of point, by type of task, by level of security, etc.

**C. Access Restrictions:** On containment applications, access restriction capability shall include the ability to require supervisory confirmation of additions and changes to the BAS and have all steps tracked in an auditing log.

**D. Containment Validations:** In containment applications, the BAS software shall conform to Title 21 CFR 11, Electronic Signatures, to provide a secure audit trail of performance and system additions and changes.

**E. Alarming and Message Routing:** BAS shall provide for alarming, alarm management, and alarm routing. Each controller shall perform distributed, independent alarm analysis, and filtering to minimize operator interruptions due to non-critical alarms, minimize network traffic, and prevent alarms from being lost. At no time shall a controller's ability to report alarms be affected by operator activity at an operator workstation or local handheld device, or by communications with other panels on the network. BAS shall provide for a prioritization scheme that allows associated routing and alarm management. Upon receipt of an alarm at a graphic workstation, the alarm condition shall be enunciated regardless of any other part of the graphic software being open. Alarm management features shall include:

1. The ability to acknowledge and silence an alarm based on appropriate user-password level
2. Automatic notification on return to normal

3. Storing the alarms in a database that shall allow various queries by system, point, etc., and by status and priority level
4. BAS shall have the capability to e-mail or send phone alarms to a central call-in desk or to designated people
5. Each new system or extension of the BAS shall include the configuration of alarm routing as required by maintenance staff.

**F. Trending:** To support commissioning and building data mining, the BAS shall be capable of trending and archiving all points on primary and universal programmable controllers at a minimum of 15 minute intervals. The BAS shall also have the capability of trending at least 3 points on each terminal controller at an interval of 30 minutes. Controller memory capability and control bandwidth shall be designed to account for this trending. Control trends shall be established by the control vendor during startup and prior to functional performance testing of the systems. When the native trend store is not in a commonly acceptable format, reports shall be scheduled to output the data to a common format. Comma separated text, Microsoft formats such as Excel and Access, and a portable database format are considered common formats.

**G. Trend Graphs:** Software shall provide for displaying line graphs or graphic plots of the trended values. Software shall support multiple scales. The control vendor shall configure these graphs in a logical manner for each system.

**H. Dynamic Graphs:** Software shall provide for real-time plotting/graphing of multiple values. The control vendor shall configure these graphs in a logical manner for each system.

#### **I. Graphic Screens:**

1. **Floor Plan Screens:** Provide graphic floor plan screens for each floor and or section of the building. Indicate the location of all equipment that is not located on the equipment-room screens. Indicate the location of temperature sensors associated with each temperature-controlled zone (i.e., VAV terminals, fan coils, single-zone AHUs, etc.) on the floor-plan screens. Display the space temperature point adjacent to each

temperature-sensor symbol. Indicate room numbers as provided by the NIH. Provide a graphic link from each zone and/or equipment symbol shown on the graphic floor plan screens to each corresponding equipment-schematic graphic screen.

- a. Provide graphic floor plan screens for each mechanical equipment room and a plan screen of the roof. Indicate the location of each item of mechanical equipment. Provide a drawing link from each equipment symbol shown on the graphic plan view screen to each corresponding mechanical system schematic-graphic screen.
  - b. If multiple floor plans are necessary to show all areas, provide a graphic building key plan. Use elevation views and/or plan views as necessary to graphically indicate the location of all of the larger scale floor plans. Link the graphic building key plan to larger-scale partial floor plans. Provide links from each larger-scale graphic floor-plan screen to the building key plan and to each of the other graphic floor-plan screens.
  - c. Provide a graphic site plan with links to and from each building graphic.
2. **System Schematic Screens:** Provide a graphic system-schematic screen for each HVAC subsystem controlled with each I/O point in the project appearing on at least one graphic screen. System graphics shall include flow diagrams with status, set points, current analog I/O values, operator commands, etc. The general layout of the system shall be schematically correct. I/O devices shall be shown in their schematically correct locations. Include appropriate engineering units for each displayed point value. English-language descriptors shall be included for each point on all graphics; this may be accomplished by the use of a pop-up window accessed by selecting the displayed point with the mouse. Indicate all adjustable set points on the applicable system schematic graphic screen, or if space does not allow, on a supplemental linked set-point screen. All outputs shall be represented in terms of percent open:

- a. Provide graphic screens for each air handling system. Indicate all control-point values (see application requirements for required points) and mode of operation as applicable (i.e., occupied, unoccupied, warm-up, cool-down). Link screens for air handlers to the heating-system and cooling-system graphics. Link screens for supply and exhaust systems if they are not combined onto one screen.
- b. Provide a graphic screen for each hydronic system.
- c. Provide a graphic screen for each terminal unit. In addition to points associated with the unit, indicate mode of operation as applicable (i.e., normal occupied, unoccupied, warm-up, maximum heating, and maximum cooling). Provide links between the applicable floor plan screen and this screen. Also, provide links to the graphics representing the parent systems.
- d. Link screens for heating and cooling system graphics to utility history reports showing current and monthly electric usage, demands, peak values, etc.

#### J. Reporting:

1. **General:** The BAS shall support automatic report generation and storage of report output in some form of database. Software shall have the capability to sort and tabulate based on point, time, point value, alarm status, etc.
2. **Building Utility Reporting:** For each new facility, the control vendor shall configure utility reports as indicated in [Section 7.3.1 Building-Level Requirements](#).
3. **Animal Facility Reporting:** Refer to [Section 7.2.6 Operator Workstations](#).

## 7.6.12 Operator Workstations Hardware

**A. General:** This section covers the hardware requirements of the operator workstation. Graphic-operator workstations shall be provided as indicated under [Section 7.2 Infrastructure](#). The software requirements are covered above in [Section 7.6.11 Software and Software Set-Up Requirements](#).

**B. Inclusions:** Below are general requirements for operator workstation computers. The A/E shall refine these requirements to keep current and be commensurate with user need. All computers provided as stationary operator workstations shall include the following:

1. Processor speed, disk-storage capacity, memory, color printer, and monitor shall be of at least what is available at the time of installation at midrange offerings from major computer retailers. The A/E shall develop full specifications from the *DRM* requirements.
2. The operating system shall be Microsoft Windows.
3. 1024 × 768 resolution (at the minimum) 432 mm (17 in.) (at the minimum) monitor
4. UPS for at least 30 minutes of operation

---

## 7.6.13 Commissioning

The BAS shall be commissioned. All testing, demonstration, documentation, and training shall be included. Refer to [Section 1.10](#) for commissioning requirements.

# Section 7.7

## BSL-3 and ABSL-3 Biocontainment

---

### Contents

- 7.7.0 Introduction
- 7.7.1 BSL-3 Laboratory: General Requirements
- 7.7.2 BSL-3 Laboratory: Additional Requirements
- 7.7.3 ABSL-3 Laboratory: General Requirements
- 7.7.4 General Pressure-Controlled Rooms
- 7.7.5 BSL-3 Laboratories: Supply Systems
- 7.7.6 BSL-3 Laboratories: Exhaust Systems
- 7.7.7 BSL-3 Laboratories: Drainage and Waste Systems
- 7.7.8 Exhaust Air Stacks (Contaminated Systems)
- 7.7.9 Variable Frequency Drives in Critical Applications
- 7.7.10 Installation Requirements
  - 7.7.10.1 Wall Penetrations
- 7.7.11 Performance and Verification

## 7.7.0 Introduction

BSL-3/ABSL-3 facilities shall meet all the requirements of the preceding sections and meet additional requirements as outlined in this section. These additional requirements provide a greater level of safety and reliability of operation. Refer to [Section 6.6](#) for additional mechanical requirements and controls related to this chapter.

### 7.7.1 BSL-3 Laboratory: General Requirements

**A. Critical Zone and Support Systems:** This section includes the requirements for the critical zones and their support systems. In BSL-3 laboratories the ventilation system must provide sustained directional airflow by drawing air into the room from “clean” areas toward “potentially contaminated areas.” These rooms shall be designed such that under failure conditions the airflow will not be reversed.

**B. Exhaust/Supply Interlock:** The interlock between the exhaust and supply shall be designed to keep negative pressure to the adjacent rooms at all times. Components shall be selected so that in any realistic failure scenario, the supply airflow rate will decrease more quickly than the exhaust for negative containment spaces or vice versa for positive spaces. This requires that the A/E consider the control sequence and actual/required responses of all drives, sensors, fans, dampers, and damper actuators. Based on this, the A/E shall confirm that all practical measures have been implemented to ensure maintenance of required pressure at all times. Specifically implement the following where applicable:

1. Provide a hard-wired interlock (between the supply controller and the exhaust controller) indicating exhaust system status and supply system status such that the lagging system can confirm operation of the leading system in the absence of the controller local area network (LAN) communication. NIH requires this interlock for less-critical laboratory spaces; however, it does not restrict the use of the control network to transmit the status information. Where multiple controllers are controlling the exhaust system, status outputs shall be wired in parallel.

*Rationale: Hard-wired interlocks are more reliable than software interlocks.*

2. Zone terminal-unit controllers shall be on uninterruptible and emergency power so they can continue to control through power interruptions.
3. Supply and exhaust systems shall be controlled by one single controller with stand-alone capability and all programming shall be provided via one programming language. Units serving BSL-3 areas shall be controlled by a primary controller, preferably the same controller which manages the supply (this shall be limited by size). Refer to [Sections 6.6.2](#) and [6.6.7](#) for requirements for supply and exhaust terminals.
4. Isolation damper closing rates shall be tuned to isolate the lagging system quicker than the leading system to ensure airflow in the correct direction.
5. Differential pressure monitors on critical containment zones shall be provided to indicate the room differential pressure (visual read-out) and shall alarm when the pressure goes beyond adjustable thresholds and time durations established in concert with the DOHS and the researcher.
6. Controllers shall have the capability to automatically restore their volatile memory upon loss of current.
7. Damper actuators shall be able to stroke the dampers within 2 seconds for both main systems and terminal systems. Damper fail positions shall be selected to fail in the direction that would maintain pressurization. Fail-in-last position actuators shall only be used with specific permission. The A/E shall submit a variance to the DTR early in the design process to request permission. See [Appendix K](#).
8. Where fireman’s override controls are used, the A/E shall consult with the DFM to determine the damper positions when the override mode is activated. They shall continue normal operating positions, but this shall be evaluated on a case-by-case basis. The fireman’s override shall not be

able to stop an air system serving a containment barrier or enclosure.

See [Chapter 6: Mechanical Design](#) for VFD requirements.

---

## 7.7.2 BSL-3 Laboratory: Additional Requirements

All requirements indicated in [Section 7.7.1](#) apply to the BSL-3 laboratory except as modified below. The BAS shall provide room-pressure monitoring and enunciate alarms when conditions are not normal.

**A. Isolation Dampers for Decontamination with Key Switch:** The mechanical systems shall include isolation dampers for decontamination. Where actuators are controlled via the BAS (a decision that shall be made with the PO and program), provide a key switch to set the position of the dampers from within the suite.

**B. Automatic Dampers:** Automatic dampers in the exhaust shall fail open. Automatic dampers in the supply shall fail closed if another means is not provided to prohibit reverse pressurization in the time specified below in the event of applicable failures. If the supply automatic damper is not providing this reverse pressure protection, it shall fail open. The position of automated isolation dampers shall be monitored (make on close). Refer to [Section 6.6.9](#) on specification requirements for the isolation dampers.

**C. Anteroom:** The BSL-3 laboratory shall have an anteroom, which shall be passively pressure-controlled (controlled to a fixed airflow offset) to create a pressure differential of between -12.5 Pa (-0.05 in. w.g.) and of -2.5 Pa (-0.01 in. w.g.) and shall also have a room-pressure monitor. The exhaust volume shall lead and the supply shall track the exhaust.

**D. Multiple Levels of Room Pressurization:** BSL-3 facilities require multiple levels of room pressurization. Digital differential pressure monitors shall be provided for each pressure-controlled zone and shall monitor pressure between each zone and its adjacent reference zone (typically at the entry side of the door to the room per *BMBL*). Pressures shall be maintained to ensure proper directional airflow between zones.

**E. Controllers:** All controllers in a BSL-3 lab area shall provide stand-alone capability at the suite level. The A/E shall clearly indicate both tracking relationships between airflow terminals and clearly indicate the biocontainment boundaries of a collection of rooms (suite) that shall be controlled by the same controller.

**F. Loss of Containment:** The A/E shall work with the researcher to analyze the potential for loss of containment due to a controller failure or a controller LAN communication failure and design the controller configuration to minimize risk. Fail positions of the air valves shall be such that containment shall be maintained in the event of failures.

**G. HEPA Filters:** The BAS shall monitor HEPA filters when they are provided.

**H. HVAC Controllers:** Controllers monitoring and adjusting the HVAC in BSL-3 areas shall be primary controllers.

**I. Cross-Limiting Loop:** In BSL-3 spaces, as the spaces are constructed to have minimal leakage, a cross-limiting loop shall be provided (the control sequence shall automatically reset the flow-rate set point in the lead terminal box upon detection of excessive flow differential) to restrict the leading system from exceeding the lagging system by a specified value that shall be set to prohibit excessive door-opening forces. Values shall be set such that the control loops do not interact under normal operation. Cross limiting does not apply to chemical fume hoods, biological safety cabinets (BSCs), canopy hoods, or other safety equipment. As an example, if the normal offset is to have the exhaust volume 75 L/s (160 cfm) higher than the supply, another control loop shall restrict the exhaust to no more than 150 L/s (320 cfm) above the supply, otherwise it could be difficult to open the lab door.

**J. Airflow Tracking:** Airflow tracking control shall maintain differential pressures of -12.5 Pa (-0.05 in. w.g.) and of -2.5 Pa (-0.01 in. w.g.) between adjacent spaces. There shall never be a condition in which the control system goes outside this range for more than 2 minutes and directional airflow must be sustained by drawing air into the laboratory from “clean” areas toward “potentially contaminated areas.” The laboratory shall be designed such that under failure conditions the airflow will not be reversed. This has significant implications for the central systems serving the BSL-3



area concerning starting, power outage, rotation, and proof logic and hardware. The monitoring requirements of a BSL-3 space include:

1. Space temperature
2. Space differential pressure with local indication
3. Alarm conditions and strobe in associated rooms, outside of all entry doors
4. Humidity (where zone-level humidity is required only)
5. Supply/exhaust velocity (total/static differential) pressure.
6. HEPA-filter pressure (refer to component) (when provided)

**K. Visual Strobe:** A visual strobe shall alarm whenever any given space pressure becomes the reverse of its intended pressure for more than 20 seconds (i.e., when a negative pressure space becomes positive) or whenever the HVAC system fails.

---

### 7.7.3 ABSL-3 Laboratory: General Requirements

**A. Animal Holding Rooms:** Where animal holding rooms are classified as ABSL-3, requirements of BSL-3 laboratories apply. This shall include events such as:

1. Power outages/transfers
2. Single component failures
3. Maintenance functions
4. Multiple simultaneous component failures that are reasonably probable (for instance, fed from a common motor control center that does not also feed other systems affecting pressurizations)

**B. Animal Procedure Rooms:** Procedure rooms shall be controlled to temperature and pressure. Procedure rooms shall be controlled much the same as indicated for laboratories with the exception that the room shall have a BSC and space differential-pressure monitoring

shall be standard. If the BSC is ducted, it may at times be isolated for decontamination. Controls must maintain suite pressurization while the BSC is being decontaminated. Either provision for an alternate path for the airflow shall be made, or adjustments to adjacent offsets shall be made when the BSC isolation damper is sensed as closed.

**C. Cage and Rack Wash Suites:** These areas shall be temperature and pressure controlled. The pressurization shall be controlled passively to maintain contaminant flow from clean to dirty areas. Only the space temperature must be monitored.

---

### 7.7.4 General Pressure-Controlled Rooms

Monitoring of space pressure with local indication is only required when the potential threat to human well-being or the research program from airborne contamination is significant and is required by the *BMBL* for BSL-3 and ABSL-3 facilities. This shall be discussed with the PO, the DOHS, and the researcher to establish this need.

---

### 7.7.5 BSL-3 Laboratories: Supply Systems

**A. Status Indication:** The status indication to be used in failure and restart logic shall consistently indicate change in status within 10 seconds. Status indications shall further be capable of distinguishing belt breaks from normal operation at minimal load. Either current switches with the intelligence required and speed of response, standard current switches applied to systems where the minimum operating amp draw shall exceed that of the no load motor at 60 Hz, or differential pressure switches are acceptable. Upon a supply fan failure, either a redundant supply fan shall start, or if the redundant fan is running, then it shall ramp up. If ramp up is not achieved or there is not a redundant fan, the exhaust fans shall be ramped down to maintain a differential pressure -12.5 to -25 Pa (-0.05 to -0.1 in. w.g.), or shutdown.

**B. UPS and Emergency Power:** Central system controllers shall also be on uninterruptible power supply (UPS) and emergency power, and must detect power interruptions and take appropriate action locally. This in effect means providing a three-phase monitor as an input to the controller.

**C. Isolation Damper Closing Rates:** Isolation damper closing rates shall be tuned to isolate the lagging system quicker than the leading systems to ensure airflow in the correct direction.

**D. Pressure Cutout Switches:** Pressure cutout switches shall be tuned to trip the unit when extended beyond normal pressure, but shall have adequate delay to avoid nuisance trips due to short transient excursions. Trips from excessive pressure shall be manually reset.

**E. Controllers Restore Volatile Memory:** Controllers shall have the capability to automatically restore their volatile memory upon loss of current.

**F. Damper Actuators:** Damper actuators shall be “fast-acting” able to stroke the dampers within 2 seconds. Damper fail positions shall be selected to fail in the direction that would maintain pressurization. Fail in last-position actuators shall only be used with specific permission.

**G. Firemen’s Override Controls:** Where firemen’s override controls are used, the A/E shall consult with the DFM to determine the damper positions when the override mode is activated. They shall continue normal operating positions, but this shall be evaluated on a case-by-case basis. Firemen’s override shall not be able to stop an air-system serving a containment barrier or enclosure. The laboratory ventilation system must continue to provide directional airflow.

---

## 7.7.6 BSL-3 Laboratories: Exhaust Systems

See [Section 7.7.5 BSL-3 Laboratories: Supply Systems](#) for requirements that apply to the exhaust system.

## 7.7.7 BSL-3 Laboratories: Drainage and Waste Systems

Refer to [Section 8.4 Drainage Systems](#) for general requirements.

For containment and high containment applications, the BAS shall monitor a common alarm from any effluent decontamination system. The BAS shall monitor the effluent temperature and alarm upon effluent temperatures above 60°C (140°F) when the effluent decontamination is done with heat.

---

## 7.7.8 Exhaust Air Stacks (Contaminated Systems)

The velocity of the exhaust air in exhaust stacks shall be controlled to maintain adequate dispersion and to prevent entrainment in outside-air systems. When systems are constant volume, no monitoring is necessary. When systems are variable air volume (VAV), bypass air is used to maintain the stacks at constant volume, no monitoring is necessary. However, if the minimum velocity is maintained by staging systems or any means where the velocity in the stack varies, an airflow velocity sensor shall be provided if the velocity cannot be calculated from measured airflow. Single point sensors positioned and calibrated shall be adequate for this.

---

## 7.7.9 Variable Frequency Drives in Critical Applications

Room pressure critical areas include BSL-3/ABSL-3 and any others identified as critical during the planning and as determined by a risk assessment. The following applies to these areas:

**A. Interface:** Interface between the BAS controller and VFD shall be hard-wired directly, point-by-point from the BAS to the VFD interface board. Interface shall not be done through digital communications except as provided supplementary to the hard-wired interface.

## **7.7.10 Installation Requirements**

### **7.7.10.1 Wall Penetrations**

Where controls penetrate biocontainment barriers, penetration shall be in accordance with the BSL-3 and ABSL-3 sealing requirements. See [Section Appendix L: Sealant Table](#).

---

## **7.7.11 Performance and Verification**

Methodologies for Ventilation system for BSL-3 and ABSL-3 shall comply with ANSI Z9.14. Testing procedures shall include function failures for actual verification of systems' performance/operation.

# Chapter 8

---

## Plumbing Design

# Section 8.1

## Plumbing General Requirements

---

### Contents

- 8.1.0 Introduction
- 8.1.1 Design Conformance
- 8.1.2 Applicable Codes and Standards
- 8.1.3 General Planning Requirements
  - 8.1.3.1 Preservation of Service and Operational Safety
  - 8.1.3.2 Centralized Services
  - 8.1.3.3 System Performance and Design Planning
  - 8.1.3.4 Energy-Efficiency and Water Conservation
- 8.1.4 System Materials
- 8.1.5 Common Technical Requirements
  - 8.1.5.1 Piping Distribution
  - 8.1.5.2 Redundancy of Critical Service Risers and Mains
  - 8.1.5.3 Valving
  - 8.1.5.4 Noise, Vibration, Supports, and Stress/Flexibility Accommodation
  - 8.1.5.5 Service Access
  - 8.1.5.6 Future Connections/Maintenance Provisions/Dead Ends
- 8.1.6 Additional Requirements for Animal Research Facilities
  - 8.1.6.1 Barrier and Quarantine Facilities
- 8.1.7 Pressure-Relief Devices
- 8.1.8 Sanitary Process Systems and Clean Spaces
- 8.1.9 Shared Lab/Clinical Crossover Spaces
- 8.1.10 Additional General Technical Requirements
- 8.1.11 Requirements for Plumbing Document Submissions
- 8.1.12 Specification of Contractor Qualifications
- 8.1.13 Testing and Commissioning
- 8.1.14 Utility Metering
  - 8.3.4.1 Pressure and Flow
  - 8.3.4.2 Pressure Boosting

## 8.1.0 Introduction

This section addresses common requirements for all plumbing and process piping systems within the scope of [Chapter 8: Plumbing Design](#) and [Chapter 12: Special Process Piping Systems](#) and provides general guidance to be used for specialty systems that are addressed on a project-specific basis. Additional requirements may be found throughout the *DRM*. Refer to [Chapter 1: Administration](#) for general requirements. Piping systems not covered within the scope of the *DRM* may be subject to additional requirements that shall be addressed on a project-specific basis. Where such systems are encountered, a clarification request shall be made to the Project Officer (PO).

---

## 8.1.1 Design Conformance

The A/E shall coordinate requirements of specialty equipment and work of specialty vendors to ensure conformance with [Chapter 8](#) and [Chapter 12](#), regardless of what discipline the work is specified under.

---

## 8.1.2 Applicable Codes and Standards

**A. Codes and Standards:** The following codes and standards are generally applicable. Refer to [Section 1.2 Referenced Codes, Standards, and Organizations](#).

1. **Plumbing Code:** Plumbing systems shall meet the requirements of either International Plumbing Code by the International Code Council or the Uniform Plumbing Code by the International Association of Plumbing and Mechanical Officials. It is acceptable to follow provisions of either code (subject to *DRM* compliance); however, requirements within the same system shall not be blended between codes.
2. **Plumbing Fixture Count:** Plumbing fixture count shall comply with the requirements of the building code applied for the design and construction of the facility. In the case of Bethesda and Poolesville campuses, the International Building Code (IBC) and International Plumbing Code (IPC) shall be used to establish plumbing fixture count.
3. **Fuel Gas Code:** Fuel gas piping (including natural gas) shall meet the requirements of the most current edition of the American National Standards Institute's (ANSI's) ANSI-Z223.1 and the National Fire Protection Association's (NFPA's) NFPA-54. Where alternative fuel gas systems are permitted (other than natural gas), compliance with the associated NFPA standard, International Fire Code (IFC), IBC, and NIH Division of the Fire Marshal (DFM) requirements are mandatory.
4. **Waste Water Discharge:** The NIH campus sewer systems are federal infrastructure, and compliance with the *DRM* is required. The NIH campus in Bethesda, MD, discharges effluent to the Washington Suburban Sanitary Commission (WSSC) municipal sanitary sewer system; therefore, effluent from the campus shall conform to the industrial waste water discharge parameters of the latest WSSC Plumbing Code in addition to the requirements of the Code of Federal Regulations (CFR) including the Environmental Protection Agency's (EPA's) Clean Water Act, National Environmental Policy Act (NEPA), National Pollution Discharge Elimination System (NPDES), and requirements of the *DRM*. Waste water discharges not connected to WSSC systems shall be in conformance with the requirements of the serving utility purveyor or regulatory agency, requirements of local health departments, the CFR including the EPA Clean Water Act.
5. **Process and Specialty Piping Systems:** Process and specialty piping plumbing systems at a minimum, shall comply with the requirements of ANSI/ASME B31.3 and ANSI/ASME B31.9, the CFR, non-conflicting published industry consensus documents, and regulatory standards. Requirements of the IFC and NFPA standards are applicable. Biopharmaceutical systems shall comply with the requirements of the U.S. Food and Drug Administration (FDA), current Good Manufacturing Practices (cGMP), and guidelines of the International Society of Pharmaceutical Engineers (ISPE) and ASME Bioprocessing



Equipment Standard. Systems serving Animal Research Facilities (ARFs) shall be in conformance with NIH Public Health Service Policy on Humane Care and Use of Laboratory Animals, requirements of the Office of Laboratory Animal Welfare (OLAW), and shall meet or exceed requirements of the American Veterinary Medical Association (AVMA) recommendations.

## 8.1.3 General Planning Requirements

Refer to [1.15.1 Common Engineering Requirements](#), and additionally comply with the following:

**A. Basic Principles:** The arrangement of plumbing systems shall be designed to promote reliability, operational flexibility, service, and capacity for renovation without affecting other areas or interfering with research.

**B. Location:** Equipment and piping for building services (especially liquids) shall not be located in spaces subject to freezing or below 4.44°C (40°F), except as specifically approved by the Office Research Facilities (ORF). Avoid locating equipment and piping near air intake louvers or similar environmental control hazards.

**C. Sizing for Equipment and Other High or Constant Demand Loads:** Demand loads of equipment and other constant or high-flow demands shall be considered separately and independent of diversities applied to general fixtures and outlets to ensure adequate capacity.

### 8.1.3.1 Preservation of Service and Operational Safety

Refer to [Section 1.15.2 Preservation of Service](#), and additionally comply with the following:

**A. Backfeed Plans:** Backfeeds shall be provided where necessary to maintain services. Tap plans shall be appropriately coordinated to mitigate potential disruptions, risks to fluid quality, impact to research, safety and facility damage. Backfeeds are not permitted in hazardous services or where the arrangement could induce any safety hazard. Where hot taps are required in non-flammable gas and vacuum systems, and lab

or domestic water systems, the use of approved titanium nickel alloy cryogenic shape memory taps may be provided.

### 8.1.3.2 Centralized Services

**A. Centralized vs. Local Services and Equipment:** Provision of centralized utility services and their appropriate distribution shall be utilized wherever possible. Core services should be available at or near to all research areas. Provision of multiple, local dedicated services and localized equipment is not acceptable in lieu of central services for routine, non-hazardous fluid system applications. This provision should not preclude local equipment which may be required to serve a specific and specialized program area that is not required in other areas of the facility; or for other reasons as approved by DTR.

**B. Limited Utility Service Demand:** Where a specialized utility service demand is limited and would only be beneficial to serve the demands of a specific or very limited program area, the use of localized services shall be evaluated and applied as appropriate.

**C. Utility Sizing:** If a major utility service is required for a project but is not present (e.g., water, compressed gas etc.), the utility sizing/capacity shall be approved by DTR. In many cases this may require upsizing of services beyond those required for an individual project.

*Rationale: Central services help to ensure the intended reliability, maintenance, quality, facility risk control and economy of each utility. Distribution of mains (or available distribution from risers) of common services ensure that laboratories may be flexible for a broad range of research.*

### 8.1.3.3 System Performance and Design Planning

**A. Adequacy of Distribution Systems and Components:** Adequate fluid temperature, pressure, and volume shall be delivered to each function through conservatively sized distribution systems designed to maintain full control of fluids through careful review of programming, equipment, operational requirements, and codes.

**B. Equipment Variability/Flexibility:** Systems shall be designed with appropriate consideration of variables between manufacturers and equipment options so as to maintain flexibility for changes during and after the design.

**C. Cleanliness and Integrity:** System design and materials shall not compromise the required purity levels or cleanliness of the systems and shall be sufficient to maintain long-term integrity and safety.

**D. Systems Capacity:** Operational throughput and usage profiles (including potential of simultaneous use) shall be evaluated for all equipment and systems shall be sized to accommodate worst case operational conditions. Use profiles of major equipment shall be coordinated with other building loads to prevent over sizing.

#### 8.1.3.4 Energy-Efficiency and Water Conservation

**A. Best Practices:** Systems shall be designed and equipment selected using best practices to achieve optimal energy-efficiency and water conservation without compromising the research program, safety, or reliability.

**B. Life Cycle Cost Analysis:** Approaches must be cost-effective, durable, holistically considered, and present a reasonable payback based upon a properly performed, comprehensive life cycle analysis. A project with a payback of 10 years or less is generally favorable.

**C. Water-Powered Equipment:** The use of once-through water-powered equipment is not acceptable.

*Rationale: Energy and water conservation are federal mandates that require responsible design. However, design approaches to achieve water and energy conservation must focus on maintaining the safe and reliable operations of the facility and consider ultimate long-term sustainability of all resources.*

### 8.1.4 System Materials

**A. Approved Materials:** Piping, fittings, and joint materials and methods shall be compatible with

system application and shall be specified in accordance with [Section Exhibit 6.3 Piping Designation, Material, Fittings, and Joints](#) in [Chapter 6: Mechanical Design](#) and any additional requirements within individual sections. Only new, unstressed and uncontaminated materials may be utilized.

**B. Labeling and Identification on Contract Documents and Installed Piping Systems:** All piping systems shall be identified using system-nomenclature-specific pipe labels. Piping shall be identified in a clear and unambiguous manner. Labeling of piping and systems shall follow NIH standards to provide consistent and uniform identification. See [Exhibit 6.3](#).

**C. Special Requirements:** In laboratory, clinical, and ARF projects, the selection of materials and installation methods shall incorporate unique program requirements (e.g., magnetic fields, special material restrictions, shielding requirements, washability, moisture, biosafety, chemical exposure etc.). Manufacturer equipment site planning guides shall be reviewed for scientific equipment and coordinated with the most stringent requirements.

**D. Buried Piping Systems:** All non-electrically conductive buried piping systems outside of buildings shall be provided with proper identification. See [Section 3.3 Site Utilities](#).

**E. Electrical:** Motors for centrifugal pumps should not exceed 1,800 RPM. Refer to [Section 10.2](#) for additional motor and VFD requirements.

### 8.1.5 Common Technical Requirements

Refer to [Section 1.15.3 Technical Requirements of Systems' Planning](#), and additionally comply with the following:

**A. Systems Capacity:** Separate from any known expansion, primary equipment, building service mains, distribution mains and risers shall be sized to provide 20% future capacity beyond actual peak design loads to allow for increased future demands and density compression. When sizing and selecting connected equipment, the A/E shall utilize an efficient capacity split and controls

arrangement to provide required redundancy and overage while still maintaining efficient operation for the normal-operating load profile. Provisions for known future expansions are made on a project-by-project basis. With prior approval of ORF, future capacity may be reduced to 10% for office and non-critical spaces.

**B. Existing Systems:** Whenever connections are made into existing systems serving new equipment, additions, or renovated areas, the A/E shall ensure the existing system will not be adversely affected or fall below the standards of codes or *DRM* requirements. The A/E may be required to study existing infrastructure and systems capacity well beyond the actual planned point of connection to ensure adequacy.

**C. Monitoring and Alarms:** At a minimum, primary equipment supply systems and other items deemed critical shall be monitored and alarm to local equipment display panels and/or other NIH approved locations. Alarms shall indicate alarm cause with multiple levels of alarm response criticality (not less than a general fault and where applicable a critical and/or emergency fault) to the building automation system (BAS). Alarms monitoring program areas of one user group shall be located such that an annunciation provides indication immediately to the responsible and affected party and personnel designated by NIH to receive and respond to such alarm condition. Alarms shall be self-monitoring to ensure alert in the event of a power or other alarm failure. Refer to [Chapter 7: Building Automation Systems](#) for additional requirements.

**D. Fail-Safe Condition and Restoration of Service:** Upon unplanned loss of energy, systems and their associated control devices shall fail only to a normally safe condition that prevents injury to persons or animals and minimizes potential damage to the structure or loss of research. Upon power failure and subsequent restoration of power, all devices required for proper system operation shall automatically restart without requiring manual intervention unless it is otherwise unsafe to do so.

**E. Equipment Redundancy:** All primary system equipment, as well as devices requiring frequent maintenance or performing major control functions (e.g., master thermostatic control valves, primary filters and primary regulators) shall be provided with not less than  $N + 1$  redundancy (in parallel), appropriately sized and selected for efficient operation and durability. The  $N + 1$  arrangement shall include equipment and components

as to avoid common, plausible failures and to minimize risks. Individual variable frequency drives (VFDs) shall be provided except that failure to an automatic across the line mode may be used (e.g., lead equipment VFD) where such would not compromise proper operation or safe system control. Separate electrical disconnects are required at control panels serving redundant equipment. Failure of programmable logic controller (PLC) conditions shall provide critical alert notification. Where an item is critically dependent on services of another discipline, the A/E shall coordinate with that discipline to minimize risks.

1. Any equipment item whose failure or routine maintenance would result in substantial loss of building operations, could impact research, or scientific equipment shall be provided with *DRM*-required redundancy. All such systems and their respective monitoring devices shall be provided with standby power. See [Chapter 10: Electrical Design](#).
2.  $N + 1$  arrangements shall be online and operational (such as automatic alternating/lead-lag), reduced load operation, or otherwise configured to ensure equal wear time, reliability, availability of the redundant source, as well as to preclude stagnation or deterioration of fluid quality.
3. Equipment which may operate suitably in an automatic (but not PLC controlled) mode may be utilized, as to avoid disruptions. Arrangements may include constant pressure bypass control arrangements (e.g., arrangements that automatically revert upon PLC failure to sequence with automatic control valves such as pressure regulators as opposed to electronic controls).
4. The design capacity split and equipment quantities shall be provided with regard to maintaining proper system operation in an energy and cost-efficient manner (e.g., providing three equipment items at 50% load may be preferable to two at 100%, or alternative capacity splits). This is particularly important if peak demand is low during much of the operating time. Devices such as major pressure control stations (PRVs) may be staged as appropriate to ensure efficient operation while maintaining capacity for essential building function.

5. Where approved by ORF, N + 1 redundancy is not required for dedicated office or other non-critical spaces; such systems shall be arranged to minimize likely failures or extended disruption. Redundancy is required for equipment providing water supply and hot water to central commercial food service, regardless of facility application.

### 8.1.5.1 Piping Distribution

**A. Routing:** Piping shall not be routed above or buried under the slab below major or critical building infrastructure, major scientific or medical equipment, electrical or data storage spaces. Piping shall not be located above surgical areas, aquatic housing or infrastructure, cleanrooms, high containment, food service or medical equipment storage, or other sensitive spaces unless directly required to serve those spaces and arranged to mitigate flood, contamination, and service access risks. Piping branches may be extended to serve equipment (including drains as required). At a minimum, mains shall not be located under infrastructure, major equipment items or sensitive spaces.

Where these provisions cannot be met and there is no feasible alternative for rerouting, ORF shall review and approve the A/E's recommended mitigation measures. Double contained piping is typically required for such piping (sewage, lab waste, hazardous waste, etc.) and when required shall include leak detection. The use of drip pans, drywall shields, and similar approaches are not typically acceptable.

**B. Access and Interdisciplinary Coordination:** Valves and components shall be accessible. Piping systems shall be coordinated with other disciplines to maintain piping access, required slopes, minimized offsets, cleanouts, and preclude blockage of access to piping by cable tray, ductwork and similar construction.

**C. Vertical Riser Distribution:** Vertical riser distribution arrangements shall comply as follows:

1. The distribution arrangement shall consist of main system vertical risers that are located in permanent mechanical shafts or at building structural columns so as to serve a complete building wing or major floor zone. In the case of utility corridor building concepts, risers may be located in the utility corridor, provided risers are

adequately sized and intertied for operational flexibility.

2. A single riser (or single set of remotely distributed primary and redundant risers for critical services) shall serve entire building wings. Multiple individual risers for individual stacked areas (with the exception of core toilet rooms) is generally not acceptable.
3. Vertical primary system risers with horizontal distribution mains shall be used to serve demands of entire floors, wings, or significant program areas.
4. Vertical risers traversing multiple floors shall be located outside the laboratory program areas wherever possible, and shall not be located behind individual fixtures, within partitions, behind casework, or in any other manner that increases floor penetrations within program space. Primary risers of non-hazardous services shall be located ideally within common areas serving multiple wings or, where serving dedicated wings, within the wing served.
5. Risers shall not be located in different wings or buildings than the area served, with the exception of risers located in common areas serving adjoining wings. Where it is necessary to locate risers within the program area, risers shall be located at permanent building columns or fixed continuous shafts, shall be full size to serve entire program areas, and shall be used only to provide supplies to horizontal above ceiling or interstitial distribution mains. Risers shall not be used as the distribution approach to serve individual fixtures.
6. Where utility corridors are utilized, vertical primary risers located in stacked utility corridors shall be provided to serve the accessible horizontal on-floor distribution of utilities located behind the laboratories. See [Section 2.3.2.8](#).
7. Systems shall be arranged such that all pressurized piping within the program area of a single lab or room may be deactivated without affecting other areas or necessitate the operation of numerous valves per system to independently isolate a complete lab, floor, or building wing.

8. Systems distribution shall be arranged so that in the event of system failure, backfeeding of individual floors or single risers serving floors will address all associated use points. Isolation of individual wings shall be possible at least on an individual floor level; therefore, it is not acceptable for adjacent wings or floors to be affected if an individual floor or group of floors within one wing, or any combination of individual floors within a wing must be taken out of service to accomplish a shutdown, renovation, or repair.

***Rationale:** Placement of risers within lab areas severely limits future flexibility and renovation independence. By locating risers at construction elements that are permanently unaffected by interior fit-out arrangements, maximum flexibility for future connections and future modifications is maintained.*

**D. Horizontal Distribution Mains:** Horizontal distribution concepts independently serving individual floors within individual wings are required. Horizontal distribution mains shall comply as follows:

1. Horizontal distribution mains serving each floor shall be independently connected to main and (where provided redundant) supply risers, and shall not serve fixtures or equipment on other floors through branch lines upfed or downfed through a floor slab. The distribution arrangement shall ensure an entire floor may be shutdown without affecting fixtures or equipment on other floors. Horizontal on-floor and interstitial floor mains may serve multiple wings only where each individual wing (or individual floor of the each individual wing) may be independently shut off without disrupting other areas.
2. Horizontal distribution mains for pressurized services shall be utilized and located on the same floor level or within the interstitial space serving the floor where equipment or fixtures are located.
3. Where pressurized services are looped or arranged as double-fed mains to maximize reliability (including use of ring main concepts), sectionalizing valves shall be provided such that a

branch or portion of the piping serving individual labs and individual floors may be shutdown without disrupting the service to the entire floor, other floors, or building areas.

4. Serpentine distribution of services from one floor to another, one building to another, one wing to another, or one ARF program area to another or in a different part of the building, is unacceptable whether or not bypass arrangements are provided.
5. Piping and valving arrangements shall allow for single point shutdown of entire individual laboratories, as well as independent isolation of each floor and building wing without affecting other areas.
6. To minimize risks of failure, leakage, maintenance access, and to minimize disruption, mains should be located outside of program areas to the extent possible (ideally above interstitial spaces or corridor ceilings). See [Section 2.3.2.8](#).

**E. Drainage Riser/Stack Locations:**

1. Vertical drainage and vent stacks (risers) shall be located at permanent building columns. Stacks may also be located in vertical chases serving stacked public toilet rooms, mechanical rooms, and within stacked utility corridors serving lab areas as part of the multifloor repetitive floor plate. Drainage and vent stacks shall not be located behind individual fixtures or lab benches traversing multiple floors.
2. Waste and vent stack and storm drain leader locations that transverse multiple floors and horizontal distribution of piping shall be independent for each building wing. Horizontal offsets shall be avoided in as much as possible in main stacks and risers.

***Rationale:** By locating drainage and vent stacks at permanent construction elements that will remain unaffected by interior fit-out arrangements, maximum flexibility for future connections and future modifications is maintained and engineering issues associated with offsets are avoided.*



### 8.1.5.2 Redundancy of Critical Service Risers and Mains

**A. Critical Service Risers:** Redundancy shall be provided for critical service risers for major facilities or as required by ORF, or per the program requirements. Critical services include: water (domestic and lab, hot and cold), high-pressure compressed air, control air, and carbon dioxide. Additional services deemed critical shall be determined on a project-specific basis in consultation with the PO, ORF, and the program. New multistory facilities and other large facilities and major renovations shall include redundancy of distribution system risers for critical services. Ring mains or double-fed mains shall be utilized for major facilities or as required by the ORF to maintain service continuity. In general, systems shall be arranged to maintain continuous service to each floor and minimize potential for single point failures or loss of service.

**B. Hot Water Returns and High Purity Water:** Redundancy is not required for hot water returns and high purity water.

**C. Utility Corridor Concept, Intertie of Risers:** In the case of distribution concepts utilizing common utility corridors, intertie of risers at top and bottom to a common main shall be provided unless more stringent requirements are mandated by the program. It is not required to intertie risers for such arrangements on each floor.

**D. Redundant Risers:** Redundant risers shall not be located in the same shaft or immediate area. Similarly, ring mains shall be arranged as perimeter or at least opposing corridor configurations and *not* placed immediately adjacent to each other.

*Rationale: Basis for redundancy is to facilitate a safe shutdown without loss of research and to minimize impacts from systems most likely subject to disruption or facility damage. Redundancy does not necessarily provide continuation of work in times of failure.*

### 8.1.5.3 Valving

**A. Isolation Valves:** Isolation valves shall be provided to facilitate independent service shutdown at each building, floor, wing, individual laboratory, suite, group of

toilet rooms, program area, and other points as required such that service and modifications may be performed without affecting other areas. Shut-off valves are required for each major corridor/main line and on all recirculation/return lines to correspond with each main or branch line supply valve.

**B. Valving Independence:** Where redundant equipment is provided, valving shall permit independent isolation and replacement of components while systems are maintained in operation.

**C. Individual Isolation:** Each fixture and piece of equipment shall be provided with an individual isolation valve or fixture stop (with the exception of individual turrets, gas or vacuum gas outlets that are not part of equipment).

**D. Riser Drain Valves:** Drains shall be provided at the base of all water risers and include National Pipe Thread (NPT) threads, valve, cap, backflow preventer (for potable and lab water), and hose cap. Additionally, they shall be arranged to preclude unacceptable dead-legs.

**E. Secure Locations:** Valves shall be located in appropriately secure locations and/or monitored in consideration of the service application, tampering risk, and result of accidental operation.

**F. Identification:** All valves, including safety valves, shall be clearly and properly identified (labeled/tagged) in a clear and unambiguous manner, correspond to the facility valve numbering and identification system, and keyed to submitted charts and electronic records. Valve identification should include the normal operating position.

### 8.1.5.4 Noise, Vibration, Supports, and Stress/Flexibility Accommodation

**A. Noise and Vibration Transfer:** Equipment and piping installations shall be designed to preclude noise and vibration transfer beyond acceptable limits, including but not limited to use of resilient supports, vibration-isolating equipment bases, flexible connectors or braided hoses.

**B. Stress Analysis/Flexibility Analysis:** Appropriate stress analysis/flexibility analysis shall be conducted for all piping systems and properly accommodated in the arrangement of piping, selection of supports, methods and application of attachment, guides, and anchorage. Forces shall be properly controlled to preclude damage



or any risks to system integrity or safety. Submit calculations/analysis to ORF for review. The use of manufactured, double-braided U-bend flex loops or flexible piping layouts is the preferred method of accommodating thermal movement. Piping systems handling hot water shall allow operation from start-up conditions, including with cold water and up to 60°C (140°F) or system service temperature, whichever is higher, without negatively affecting system piping support.

**C. Hazardous Fluids:** The A/E shall avoid use of bellows-type expansion joints for any fluid deemed hazardous. The use of appropriate loops, guides, and anchorage should be provided for such systems.

***Rationale:** Bellows joints are subject to failure, especially if under torsional or lateral movement conditions. In all cases, appropriate guides must be provided and joints must be applied with good engineering practice.*

**D. Expansion Joint Locations:** The location of all expansion joints shall be recorded in Operation & Maintenance (O&M) manuals and noted for routine inspection.

**E. Noise and Vibration Criteria:** The A/E shall consider maximum acceptable noise and vibration criteria in all equipment selection, its location, and system design relative to the application criteria.

**F. Compatibility:** Where flexible connection devices are utilized, the selected device shall be specifically compatible for use with the fluid system contents, including cleanliness, purity, elastomer selection, maximum temperature, and pressures. Internal corrugations should not be used on sanitary services.

**G. Control Units and Guides:** The A/E shall ensure appropriate application of control units with flexible connectors and proper system guides and anchorage. Refer to [Chapter 4: Architectural Design, Section 4.6 Furnishings and Equipment](#) and [Chapter 6: Mechanical Design](#) for additional details related to specific noise and vibration limits. All expansion/contraction devices shall be provided in the appropriate orientation, operating position, accommodation of movement and with all required anchorage, guides, loops, dimensional length etc. Application and installation must be inspected.

**H. Piping Systems and Support:** Piping systems shall be independently and properly supported in accordance with referenced standards and manufacturers' recommendations, utilizing approved materials, methods, and sufficient safety factors for all components and anchorage. Equipment and appurtenances shall be independently supported so as not to impose stresses and to facilitate ready repair, disassembly, and replacement without inducing any need to provide additional support and to preclude displacement of the piping system or equipment. Alignment of equipment and appurtenances shall not be forced and misalignment tolerances shall be in full conformance with requirements of referenced standards and manufacturer requirements. Piping, fixtures, and appurtenances shall be mounted and secured only to building structure or suitable supports; anchorage to drywall is unacceptable. The A/E shall specify provision of blocking, including for any surface mount piping.

**I. Pipe Supports In Special Areas:** Piping supports in ARF areas, cleanrooms, and areas subject to moisture or special cleaning concerns shall be of an approved, non-corrosive type which stands-off from finished surfaces not less than 25 mm (1 in.) and is free of sharp edges and concealed spaces susceptible to dirt accumulation or harborage of insects. All pipe supports, including those for surface mounted piping shall be secured to structure. The A/E shall specify provision of blocking plates as required. The use of toggle bolts and similar hollow wall anchors is not acceptable for mounting of piping or appurtenances.

#### 8.1.5.5 Service Access

Refer to [1.15.1 Common Engineering Requirements](#).

#### 8.1.5.6 Future Connections/Maintenance Provisions/Dead Ends

**A. Application:** Where provisions for future connections are provided, they shall be arranged to minimize length and quantity of dead ends. Capped stub-out including isolation valve shall be provided and terminated directly at active mains or risers. Where services are renovated, dead ends shall be removed to the point of connection with active mains.

**B. Valved and Capped Connections:** A valved and capped connection shall be provided from each riser serving pressurized fluid and vacuum systems at each floor level, along with a full-sized valved and capped connection at the top and bottom of each riser where necessary or deemed beneficial for future expansion.

**C. Future Connections/Renovations:** Runouts should be sized the same size as the branch serving the floor. Where future connections are made, a new valved and capped connection shall be maintained.

**D. Dead Ends:** Dead ends shall not be made in potable water systems, high purity water systems, animal drinking water systems, or any hazardous process system. Where valved and/or capped provisions are required in water systems, lengths shall be minimized (and typically should not exceed 6 pipe diameters in length), but do not require zero-static valves.

**E. Documentation:** The intended use of capped/valved connections shall be documented, at a minimum, in project Basis of Design (BOD) and valve charts and drawings shall be marked to indicate intent (e.g., capped for future, drain, etc.).

## 8.1.6 Additional Requirements for Animal Research Facilities

Refer to [1.15.4 Supplemental Technical Requirements for Animal Research Facilities](#) and [Section 12.2 Animal Drinking Water Systems](#) for drinking water, [Section 12.5 Veterinary Medical Gas Systems for Animal Research Facilities](#) for compressed gas, vacuum, and anesthetic scavenging systems. Additional requirements related to water, drainage systems, and specialty equipment may be found in the respective sections of the *DRM*.

### 8.1.6.1 Barrier and Quarantine Facilities

**A.** Special care is needed in the design of barrier facilities to minimize potential for cross-contamination and to maintain the sanitary environment. Considerations such as quality and source of animal drinking water, protecting services from contamination, sealing and

cleanability of penetrations and exposed materials, and maintaining spatial functionality independent of adjoining non-barrier spaces shall be addressed. Comply as follows:

1. Boundaries of barrier facility areas shall be designed according to program requirements and shall be clearly designated on drawings.
2. Penetrations shall be rigid, gas- and water-tight, and visible for inspection and maintenance.
3. Utility services shall be provided in sufficient quantity and locations to permit required program functions to serve both barrier and non-barrier animal spaces with minimal risk of cross-contamination.
4. Equipment and service access shall be arranged to occur from outside the space where possible and shall be approved by the program use group.
5. Piping systems shall not circulate or serpentine between barrier and non-barrier spaces.
6. Segregation arrangements shall be reviewed with the program and approved by the NIH with regard to potential cross-contamination concerns and project-specific limitations.
7. Hand washing sinks shall be provided and be hands-free (equipped with electronic sensor or off-the floor mounted foot pedal) fixtures with laminar flow (non-aerating) outlets.
8. Animal drinking water shall be addressed as required in [Section 12.2 Animal Drinking Water Systems](#) for barrier facilities.
9. Water serving washing and sterilizing equipment shall conform to the requirements of the program. At minimum, potable water is required for these applications, with local backflow protection per plumbing code.
10. Floor drains are typically not provided in barrier small animal (e.g., rodent/rabbit) suites. In applications where floor drains are required, drains and grates shall be constructed of 316 stainless steel, readily cleanable and free of concealed fouling spaces, and shall be furnished with automatic electronic time-clock-actuated

trap seal primers. Where drains are required by the program, they shall be capable of being sealed gas-tight. Clean outs and other maintenance items shall be located outside the barrier.

11. Avoid access doors and openings into walls or ceilings in these spaces.
12. Avoid routing of piping and equipment serving other areas, or not required directly to serve barrier spaces, within the barrier space.

---

## 8.1.7 Pressure-Relief Devices

**A. Location:** Discharge shall be to approved safe locations where discharge will not cause damage to facilities or hazards to occupants and appropriately arranged to address potential built-up or superimposed backpressures.

**B. Rupture Disks:** Where rupture disks are provided ahead of pressure-relief valves (such as for sanitary, contaminated, or hazardous applications), interspace pressure monitoring is required to indicate a pressure buildup or burst disk. Disks shall be provided with manufactured disk holder and an appropriate torque nut. Provide dual type (pressure/vacuum) disks as required. Disks in high purity systems shall be appropriate sanitary type. The A/E shall consider the disk safety and sensitivity margins and shall make selections to minimize required maintenance and replacement frequency.

**C. Two-Phase Flow:** The potential for two-phase flow (gas/liquid) shall be evaluated for relief-valve and rupture disk installations and adequately sized.

**D. Relief Valves:** Relief valve arrangements shall be designed so as to be protected from blockage, including trapping of water/liquids, condensate, or other impediments to proper and safe discharge. For clean systems, relief valve piping shall be arranged to protect from inducing contamination to the process. Relief valve discharges shall not be interconnected with piping or systems used for any purpose other than to adequately convey relief valve discharge. Connection to any contaminated system or plumbing venting system is unacceptable.

***Rationale:** Rupture disk control and monitoring is required as it allows for safe control of the process, alert to burst disk failure, and to prevent an unsafe pressure buildup on the back side of the disk which could ultimately result in excessive pressure buildup prior to tripping due to the trapped space between the relief valve and the back of the disk. With the general exception of compressed air and general plumbing water systems at safe temperatures, discharge from all piping systems (even inert gases such as nitrogen and CO<sub>2</sub>) should be considered hazardous and discharged only to safe exterior locations unless appropriate safety measures and engineering has been provided to ensure a safe discharge of maximum potential quantity/rate.*

---

## 8.1.8 Sanitary Process Systems and Clean Spaces

**A. Sanitary Standards:** Provision of sanitary process systems, including but not limited to validated systems, sterile systems, cleanrooms, current good manufacturing processes (cGMP, etc.), shall be provided in accordance with Food and Drug Administration (FDA) regulations, ISO practices, approved sanitary standards (such as ASME BPE and ASME B31.3 Chapter X) and NIH project-specific requirements. Systems shall be arranged to ensure reliability and to maintain protection from contamination hazards.

**B. Penetrations:** Penetrations in cleanroom spaces shall be visible with the penetrating item braced to structure so as to maintain penetration integrity and with an exposed, visible, readily cleanable seal.

**C. Fluids Quality:** Water supply to cleanrooms and similar spaces shall be not less than potable quality (isolated potable water as required). Compressed gas services shall be independent as required to maintain fluid quality. Cleanroom service source and distribution for high purity services shall not be shared with lower purity, non-validated functions.

**D. Quality-Control Plan:** A suitable quality-control plan shall be developed and followed to ensure proper design and installation. The A/E shall provide comprehensive

specifications and documentation to ensure proper installation by qualified personnel. See [Section 8.1.12 Specification of Contractor Qualifications](#).

**E. Validation:** Validation steps, where applicable, shall be fully incorporated, and where not applicable, at a minimum systems shall be subject to commissioning, verification, and design review. Independent and comprehensive quality assurance shall be provided for systems with a significant potential safety concern or other critical consequence.

**F. Control:** Strict control shall be maintained over all aspects of design and materials. This shall include verification of materials provided to the project site and proper installation, cleaning, and validation.

---

## 8.1.9 Shared Lab/Clinical Crossover Spaces

**A. Restrictive Clinical Use:** Where a space is utilized in a manner that involves clinical (human) use, spaces shall be designed for the most-restrictive clinical function.

**B. Water Supply:** Water supplies shall be direct from potable water with point of use (local) dedicated backflow protection in accordance with plumbing code.

**C. Medical Gas:** Medical gases for human medical and other uses shall not be shared with other functions. It is recommended that services be provided based upon the dominant need and application of the facility, with the remaining application provided as a portable, temporary service. In all cases, outlet types and equipment shall be distinctively keyed and labeled to protect from misuse or cross-contamination.

---

## 8.1.10 Additional General Technical Requirements

Refer to [Section 1.15](#) and additionally comply with the following:

**A. Drainage Provisions Required:** Outlets and openings into water piping systems shall be provided with

a drain receptor or be located only in areas where discharge under normal or malfunctioning conditions will not cause flooding, damage, or accumulation of water. Examples include but are not limited to faucet taps, bottle fillers, plumbing fixtures, and appurtenances.

**B. Valve Groupings:** To the extent possible emergency shutdown valves shall be grouped/co-located.

**C. Equipment Location:** Equipment such as pumps, water heaters, thermostatic control valves, backflow preventers, compressors, trap primers, drains, standpipe receptors, and indirect wastes shall not be located above ceilings, inaccessibly concealed within walls or any otherwise concealed space. Additionally, equipment shall not be located where subject to tampering or unauthorized access. Local trap primers and local (point of use) thermostatic valves may be located within casework where required. Pressure regulators and routine shut-off valves may be located above accessible ceilings as appropriate.

**D. Valve and Appurtenance Sizing:** Control valves (e.g., check valves, thermostatic, balancing, etc.) shall be sized based upon engineering calculations for the fluid and application. This includes Cv, flow, pressure drop and effective control range. Sizing merely on pipe line size is not acceptable. Where pipe size changes are required, they shall be made immediately adjacent to the component.

**E. Liquids and Steam Discharge:** Devices which may discharge liquids, waste, or steam (e.g., backflow preventers, relief valves, etc.) shall not be located above gypsum ceilings, plywood interstitial walk ways, or other areas where damage may result from discharge.

**F. Instrumentation and Controls:** Instrumentation shall be provided to directly monitor all key parameters of each system and shall be selected so as to be appropriate for the specific application and fluid quality. Instrumentation and controls shall be of a quality type, hard-wired (not wireless), and with appropriate accuracy and repeatability, calibrated National Institute of Standards and Technology (NIST) traceable, and properly configured and accessible for reading, maintenance, replacement, and selected so as to be direct reading/automatically calibrated to the specific process fluid application. Instruments shall be provided with wells, isolating diaphragms, or other appropriate manufactured instrument fittings and shall be located

at effective points in the system. Unless otherwise specifically approved by the PO, PLC's shall maintain an open system architecture so as to be compatible with other manufacturer's products.

**G. Systems Integrity:** All systems shall be properly flushed, purged, tested, and maintained to protect system quality and integrity throughout construction and prior to installation of equipment, instrumentation, and controls.

**H. System Construction, Cleaning, and Pre-use Maintenance:** Systems shall be appropriately cleaned and constructed for the required fluid quality. Corrosion-resistant properties of all systems shall be maintained throughout construction.

**I. Pre-Turnover Verification:** After systems are cleaned and prior to turnover, the A/E shall specify for verification that all required filters and appurtenances are in place, appropriately validated (as applicable), of proper type, and that all required controls and devices have been properly adjusted.

**J. Passivation:** Where passivation derouging, and electropolishing is required (whether on-site or as part of component construction), such work shall be specified to be provided by qualified firms specializing in biopharmaceutical-type high purity passivation applications who are ISO 9001 certified with full documentation of quality control procedures. Services shall be provided in accordance with both ASTM A380 and ASTM A967, along with certification of passivation, testing, and certification of complete and proper rinsing, drying, and protection from post-treatment contamination.

**K. Double Containment and Annular Space Leak Detection:** Where double containment piping is provided, piping support, thermal flexibility, and transitions shall be detailed. The use of low point automatic leak detection is typically preferred over cable-type leak detection systems for drainage. Where cable-type systems are utilized, systems shall be designed to facilitate replacement of the cable and shall include pull ropes. Products shall be selected and designed to facilitate in-place drying and reuse.

## 8.1.11 Requirements for Plumbing Document Submissions

**A. Plan Information and Location:** Sufficient detail shall be provided in drawings and schedules to clearly indicate system requirements. In general, system detailing shall not be so generic as to require contractor or vendors to perform professional design tasks. With the exception of very small renovation projects, dedicated plans for plumbing systems shall be provided (independent from HVAC or other system plans).

**B. Legend Sheet:** A detailed legend sheet shall be provided for all plumbing line types, abbreviations, symbols, and instrumentation utilized.

**C. Piping Documentation, Flow, and Nomenclature:** All pressurized piping systems shall be provided with flow arrows on drawings to indicate direction of process flow. Each piping system and component shall be provided with distinct and sufficient nomenclature on each drawing to promote legibility and clarity. The nomenclature should correspond with piping tagging and identification text, and with system identification nomenclature requirements. All gravity-drainage piping drawings shall be provided with indication of the required installed slope and sufficient notations of piping invert elevation.

- 1. Underground Plan:** A separate plan shall be provided to indicate buried plumbing systems. Piping systems and components installed above the floor shall not be shown on the underground plan. All underground plans shall show foundation footings, respective grade beams, the overlying floor plan, partition layout, room names/type, and significant equipment and furnishings to be installed on the floor located on-grade. Waste lines shall indicate slopes and invert elevations.
- 2. Typical Plumbing Floor Plans:** Plans shall indicate partitions, room names/type, room numbers, and significant equipment/furnishings for the same floor on which the piping is located. All plans shall include structural column/grid lines. Mechanical/electrical/plumbing (MEP) equipment room plans shall clearly indicate service access and traffic aisle space as well as locations or outline of significant equipment for other



disciplines (which can be shown as background). All piping, including sanitary and lab waste lines, shall be indicated on the plan of the floor for which the piping is actually to be located. The use of notes to designate that piping is installed below the floor or on the floor above is not acceptable. Floor drains and buried structures for the lowest on-grade slab shall be shown and called out on the underground plan; additionally, drain tops shall be shown on the respective floor plan such that the position of floor drains may be clearly spotted in relation to the plan/furnishing attributes.

3. **Schedules:** At a minimum, schedules shall specifically identify equipment and fixture connection requirements, equipment/appurtenance design capacities and correct adjustment of significant normal operating parameters, unless such information is clearly indicated elsewhere.
4. **Operating Criteria:** The required pressure adjustments and flow rates for devices such as balancing valves, flow controls, pressure-reducing valves, booster pump controls, and other items requiring field adjustments shall be indicated on the drawings, or within drawing schedules. Where complex operating criteria is involved (such as in certain process systems), such criteria may be contained in accompanying Process and Instrumentation Diagrams (P&IDs) and operation sequences as appropriate.
5. **System Riser Diagrams:** Riser diagrams shall be provided for all plumbing/piping systems for buildings over one story in height, for all facilities operating at BSL-3 or above, for all process piping systems, and where otherwise required to clearly communicate design intent and necessary detail. Fixtures/equipment callouts shall be indicated on riser diagrams. Room numbers, reference lines, or other means to permit rapid interpretation of the riser to the corresponding plan area shall be provided. Riser diagrams may be orthographic (elevation) or isometric; however, particular attention is required to ensure accuracy of the representation of fittings, appurtenances, sizes, and order of branches.
6. **Drawing Scale:** Plumbing plans for above-ground systems in lab, ARF, kitchen, and mechanical room spaces shall generally be shown at a scale of not less than 1:50 (0.25 in. = 1 ft.) and underground systems at a scale not less than 1:100 (0.125 in. = 1 ft.). Plans depicting process fluid systems (including medical gases) shall be shown on separate plans from the conventional plans such as water, waste, fuel gas and storm, except that shared plans are acceptable with an appropriate scale of not less than 1:50 (¼ in. = 1 ft.).
7. **Equipment Connections:** Plumbing connections to laboratory, medical, food service, ARF, high purity water, and other specialty equipment shall be fully detailed on drawings. The A/E shall not rely on space and equipment consultant planners alone to ensure appropriate engineering systems or proper system connections.
8. **Process Diagrams:** Where specialty process systems are provided, the design shall include Process Flow Diagrams (PFDs) and P&IDs for prior review by the NIH. Preliminary operational and key control sequence descriptions shall be provided along with appropriate PFD diagrams as depending on system complexity and necessity to adequately convey key information and salient features for design review and construction. P&IDs shall include a full written sequence identifying key operational, control, and safety elements along with instrumentation detailed in accordance with International Society of Automation (ISA) standards. In some cases it is understood final P&ID's may not be generated until after the contract is awarded. In such cases, final P&ID's and sequence of operations shall be submitted for review and approval prior to procurement and consistent with PFD concepts and sequences as approved by the NIH. Written sequences of operation are required for all high purity fluid, hazardous fluid, and process systems or plumbing systems with two or more automated control devices.
9. **Packaged Systems and Vendor Designs:** The design documents shall thoroughly communicate system engineering requirements. In general, the A/E shall not leave engineering activities up to the discretion of contractors and



vendors. This is not intended to preclude the assembly of primary manufacturer-engineered and assembled equipment; however, the design documents must be provided with sufficient detail so that the NIH may confirm acceptability of the proposed arrangement during design document reviews. In certain cases the PO may require additional submission of detailed drawings of vendor-arranged systems for concurrence prior to procurement. The use of packaged systems, packaged equipment, and system arrangements that incorporate vendor design activities may be subject to additional review by the NIH prior to approval. Regardless, the A/E shall indicate requirements to comply with the *DRM* and provide sufficient guidance to ensure successful submissions that avoid the delay of projects.

10. **Specifications:** The A/E shall include in the project specifications that all systems shall be tested and inspected for conformance with the contract documents and the *DRM*. Specifications shall require that each plumbing installation be inspected, signed off, and thoroughly tested prior to concealment. Plumbing work shall be reviewed for proper slope, joints, layout, materials, and installation. Testing shall be provided for all systems and witnessed prior to backfill, concealment in walls, and again at final completion. All installations shall be tested and inspected by qualified inspectors to at least the same degree as would be required for an off campus installation. Final inspection tests shall confirm proper installation and adjustment, code compliance, completeness, omission of cross-connections, leakage, and protection and preservation of systems until project turnover.
1. All plumbing installations (water, drainage, and gas) shall be provided by personnel with a current U.S. (state) or jurisdictional licensure, at not less than journeyman level, with responsible master plumber oversight.
  2. Process piping systems shall be installed by pipefitters/process piping fitters of not less than unrestricted journeyman level, and qualified in accordance with standards of the industry or greater as required. High purity and hazardous systems shall be installed by personnel appropriately trained and for such installations specific to the system type, fluid, and purity grade, who shall be licensed and experienced for the activity, and trained as a pipefitter.
  3. All welding and brazing shall be carried out by qualified welders and brazers (respectively) in accordance with ASME Code and American Welding Society (AWS) standards for the material, method, personnel qualifications, and size range utilized. Where medical/veterinary medical gas systems are utilized, pipefitters/plumbers with ASSE series 6010 medical gas installer certification is additionally required.
  4. Weld inspection and other non-destructive testers as may be required shall be appropriately qualified. Non-destructive testers shall be in accordance with ASME B31.3 or B31.9 as applicable, and shall be minimum Non-Destructive Testing (NDT) Level 2 or NDT Level 3 personnel for the test method per SNT-TC-1A of the American Society for Non-Destructive Testing or approved equivalent. 100% testing is required for hazardous fluid systems. The use of various NDT test methods (e.g., radiographic testing) shall be pre-approved by the NIH in consideration of potential impact to science. All instruments shall include current, National Institute of Standards and Technology (NIST) traceable calibration. All laboratories utilized in testing/analysis shall be accredited in accordance with ISO 17025.
  5. Minimum qualifications for third party system verifiers for high purity systems, veterinary medical gas, process, and ultra-high purity gas systems shall be as approved by the NIH. Refer to other sections specific to the application.

---

## 8.1.12 Specification of Contractor Qualifications

**A. Qualified Personnel:** Specifications by the A/E shall require use of appropriately qualified, licensed personnel, properly trained, experienced to perform installations, and in compliance with federal regulations.

6. All support contractors (system cleaners, test agencies, verifiers, cross-connection control device testers, etc.) shall be appropriately qualified, and shall be specified in accordance with project requirements.

### 8.1.13 Testing and Commissioning

**A.** All systems and equipment shall be cleaned, purged free of contaminants, and tested and adjusted for proper operation and leak integrity. Systems shall be fully commissioned, including performance of integrated systems testing, comprehensive functional performance tests, and complete commissioning of the source equipment and distribution to point of delivery. Systems deemed hazardous, of critical purity or sterility, or necessary for life-support shall be properly verified and, where applicable validated. Refer to [Section 1.10](#).

**B.** Systems operational training shall be provided.

**C.** Testing and system cleanings shall be conducted under supervised conditions. Systems under test pressures, unsafe temperature, and systems filled with cleaning or sanitization chemicals shall not be left unsupervised. All appropriate safety precautions shall be maintained to protect facility and occupants.

**D.** Test methods and equipment shall not induce contamination, over-pressurization, or damage.

**E.** Proper bleeding of air is required prior to hydrostatic testing.

***Rationale:** Failure to bleed air prior to hydrostatic testing can result in safety issues, excessive stresses, or failure to adequately test.*

### 8.1.14 Utility Metering

**A. General Requirements:** Utility metering shall be provided for primary utility services serving each building from the central plant or campus underground infrastructure, and shall be capable of automatically registering peak flow and totalization to the NIH building automation utility monitoring systems. A normally closed and lockable bypass shall be provided to facilitate continued service. Meters shall be located indoors near the point of entry of the serving utility or prior to branch take-offs, and ideally should be located in mechanical rooms or in similar above-ground accessible utility spaces. At the NIH Bethesda Campus, meters are not provided for natural gas or fire service or for the portion of any combined water service that supplies fire sprinklers or hydrants. The following meter types and application areas are required:

1. **General Water Systems:** General water systems shall be American Water Works Association (AWWA) C701 compliant. Meter size of 3 in. and larger shall be in-line electromagnetic type, capable of recording flow rate as well as consumption. Consider flow direction potential and totalization requirements in meter system selection as may be affected by dual feeds. In such cases, electromagnetic metering with meters selected for unidirectional flow is suggested. Flow tubes shall be properly grounded in accordance with manufacturer directions. In-line ultrasonic units may be approved with sufficient independent documentation of accuracy and reliability. AWWA compliant compound and turbine meters may also be used where capable of accurately recording both peak flow rate and consumption data, and compatible with flow characteristics.
2. **Cage Wash Equipment:** Metering shall be provided for the makeup water supplies serving central cage wash areas, or an arrangement that provides for recordation of demands from central cage wash equipment provided.
3. **Compressed Air:** Metering shall be provided for compressed air from the central plant in accordance with [Section 12.3 Compressed Gas and Cryogenic Systems](#).

**B. Submetering:** Submetering shall be provided at additional plumbing utilities and system makeups only where required by the program or requested by NIH.

**C. Metering of Off-Site Projects:** For off-campus and extramural projects, provisions of meters shall be in accordance with the facility standards or administrative authority requirements at the project site; however, the arrangement shall provide for continuous (undisrupted) service.

*Rationale: Metering of incoming water utilities provides data to allow NIH to track consumption in individual facilities and systems, and can help promote energy-efficient strategies and to monitor and promote sustainable performance.*

# Section 8.2

## Plumbing Fixtures and Equipment

---

### Contents

- 8.2.0 Introduction
- 8.2.1 General Requirements
- 8.2.2 Special Requirements for Stainless Steel Products
- 8.2.3 Water Closets
- 8.2.4 Urinals
- 8.2.5 Lavatories/Sinks/Hand Sinks
- 8.2.6 Faucets and Spouts
- 8.2.7 Foot Pedal and Dual Actuation Valves
- 8.2.8 Battery-Powered and Self-Sustaining Automatic Faucets and Flushometers
- 8.2.9 Showers
- 8.2.10 Emergency Showers and Eyewash
  - 8.2.10.1 Emergency Fixture Location
  - 8.2.10.2 Emergency Fixture Equipment Requirements
- 8.2.11 Janitor Sinks/Mop Sinks/Janitor Closets
- 8.2.12 Drinking Fountains and Bottle Fillers
- 8.2.13 Hose Bibb/Hydrants
- 8.2.14 Waste Disposers
- 8.2.15 Dishwashers
- 8.2.16 Lab and Animal Research Facility Equipment
- 8.2.17 Lab Sinks
- 8.2.18 Labware Washers and Autoclaves
- 8.2.19 Incubators
- 8.2.20 Fume Hoods and Biological Safety Cabinets
- 8.2.21 Lab Gas Turrets
- 8.2.22 Downdraft/Backdraft/Necropsy/Tables, Dissection/Grossing Stations, and Equipment Served from Lab Water
- 8.2.23 Hose Stations
- 8.2.24 Lab Equipment Water/Waste Outlet Box
- 8.2.25 Fixture Trim Requirements
- 8.2.26 Floor Drain and Floor Sinks: General Requirements
  - 8.2.26.1 Floor Drain and Floor Sink Materials of Construction
  - 8.2.26.2 Floor Drains in Laboratories: Additional Requirements
  - 8.2.26.3 Floor Drains in Animal Research Facilities, Additional Requirements
  - 8.2.26.4 Floor Drains, Trench Drains, and Troughs in Large Animal Spaces
- 8.2.27 Roof and Overflow Drains

## 8.2.0 Introduction

This section addresses requirements for plumbing fixtures, fittings, trim in all NIH facilities including items that may be unique or specifically designed for use in a laboratory, animal research facilities (ARF), and other specialized program areas.

The requirements of this section are applicable to all plumbing fixtures and equipment, including those items specified as part of laboratory, ARF, food service, or other specialty equipment.

## 8.2.1 General Requirements

**A. Standards and Performance:** Plumbing fixtures shall be selected to provide appropriate function, durability, and quality recognizing sanitation requirements, reliability, corrosion resistance and potential for cross-contamination.

**B. Compatibility:** Plumbing fixtures and equipment shall be non-corrosive and suitable for the ambient conditions of the area where the fixture is located. Fixtures within an ARF or other moist/wet areas shall be stainless steel or other approved materials. Galvanized material is not acceptable (including for exposed piping and emergency showers).

## 8.2.2 Special Requirements for Stainless Steel Products

**A. Corrosion/Contamination:** Stainless steel products shall be specified to be suitable for the process sanitary condition and to resist corrosion commensurate with the application. The following shall be addressed where stainless steel is utilized: Weld quality, post-weld passivation, sufficiently smooth surface profile, and care during fabrication, construction and cleaning to prevent surface contamination especially from carbon steel, graphite, and chlorides.

**B. Required Alloy:** The appropriate alloy shall be selected for the process fluid, chemical exposure, and internal and external environmental conditions. Typically, the minimum grade alloy shall be American

Iron and Steel Institute (AISI) type 304. Not less than AISI type 316 shall be used in the following areas: spaces exposed to chemicals, frequent cleaning or washdown requirements, ARF wet areas, items cast in concrete or buried, items carrying fluids of high purity or carrying water which has been chlorinated, any surfaces exposed to substantial or repeated contact with exterior environment, chemicals, or repeated surface staining materials, items connected to the lab waste system, and items located in cage wash. The use of AISI 316, 316L and 316Ti alloys shall each be selected as appropriate and where the *DRM* indicates provision of type 316 alloy.

### C. Appropriate Surface Finish:

1. All plumbing fixtures or finished exposed components must have a finish that is no less than a surface smoothness of 36 microinch Ra. The use of #4A sanitary finish (24–40 microinch) or better is required for applications in ABSL-2 and above and for sanitary/high cleanliness spaces, except where a more sanitary finish is required. Sinks not exposed to chemicals or of other concern unique to the program may be manufacturer's standard polished finished consistent with the product's listings.
2. The minimum finish for stainless steel utilized for any area susceptible to chemical use or other enhanced risk of corrosion shall have a maximum surface roughness of 0.5 microns (values below 20 Ra).
3. All welded areas shall be smooth and blended to the surface finish and free of crevices.
4. Stainless steel shall be protected from construction chemicals and cleaners, muriatic acid, chlorides, etc., and from contact with ferrous material throughout the fabrication, handling, and construction process or from other stagnant conditions, chloride exposure, or other conditions that may induce corrosion. Fabricated components and any components that have been welded in the field or by the contractor, which are in contact with a process fluid (including water and waste) or where required shall be passivated, rinsed, and dried by qualified passivators in accordance with ASTM A967 and ASTM A380.

**D. Chlorides:** Where chlorides may be present in concentrations corrosive to 316 grades of stainless steel, alternative materials or alloy grades shall be proposed for NIH approval.

*Rationale: Substantial expense and delays can result from failure to address factors which may result in corrosion of stainless steel or other materials.*

### 8.2.3 Water Closets

**A. Water Closet and Flushometer Type:** Water closets shall be wall-mounted, flushometer-valve type, with an electronic hands-free flushometer, hard wired, and on standby power. The use of manual flushometers is discouraged, but may be approved on a case-by-case basis for non-public, non-food service areas. Where standby power to flushometers is not available, units with non-hold open mechanical manual flush override are acceptable. All flushometers shall include an override to permit manual flush. Water closet flush volume shall be either dual flush volume 4.2/6.0 liters (1.1/1.6 gallons) per flush, or 4.28 liters (1.28 gallons) per flush. All fixtures shall be designed for full ANSI/ASME A112.19.2 compliance at the lower flush volume. All dual flush water closets shall be designed for dual flush operation and the dual flush activation shall be hands free.

**B. Water Closet Construction and Performance Requirements:** All water closets shall be designed for heavy commercial/institutional use and have a maximum performance report (MaP) flush performance rating of at least 1,000 grams. The water closet trapway shall provide not less than a 2 in. ball pass.

**C. Higher Flush-Volume Water Closets:** Higher flush-volume water closets may be used subject to any of the following conditions:

1. 13.2 liters per flush (lpf); 3.5 gallons per flush (gpf) or 6.0 lpf (1.6 gpf) fixtures are acceptable where the use of reclaimed water has been approved and provided for flushing, including use of blow-out flush action fixtures.
2. 6.0 lpf (1.6 gpf) closets may be utilized for applications in existing facilities where the plumbing

system arrangement, piping size, or slope are likely to contribute to excessive blockages when used with lower flow fixtures. Other flush volumes shall be subject to justification of need.

3. Where required in the DRM (e.g., BSL-3 to clear deep traps).

**D. Closet Carriers and Trim:** Water closets shall be provided with commercial-/institutional-grade closet carriers with dual feet plus an auxiliary anchor support secured to structure with appropriate manufacturer recommended hardware, and institutional weight open front seats furnished without covers and with heavy-duty stainless steel check hinges. The use of neoprene or felt gasket seals shall be provided for wall mount water closets and where recommended by the manufacturer.

*Rationale: Carrier configuration and seats are to ensure durability and sanitation. Wax seals are incompatible with some low flow closet designs and may block fixture outlets.*

### 8.2.4 Urinals

Waterless urinals are not permitted. Urinals shall be one of the following:

1. **Wall-mount Type:** Siphon jet, or preferably blow-out action type with a flush volume of 2.0 to 3.8 lpf (0.5 to 1.0 gpf) in conformance with ANSI/ASME A119.19.2, with individual electronic hands-free sensor-operated flushometer, hard wired, and on standby power. The use of manual flushometers is discouraged, and may be approved only on a case-by-case basis for non-public, non-food service areas. Where standby power to flushometers is not available, units with non-hold open mechanical manual flush override are acceptable. Urinals shall be selected with not less than a 25 mm (1 in.) diameter trapway. The use of conical or funnel shape urinals with an integral rim may be used (including units of wash-out type) subject to conformance with these requirements. All flushometers shall include an override to permit a manual flush.



2. **Flush in-floor, Stall Type:** In-floor urinals shall have a washout flush action with an integral rim wash and a flush volume of 3.8 lpf (1.0 gpf). These urinals shall be flushed by an electronic timer-actuated flushometer, set for automatic flushing on an approved regular interval. Stall urinals shall be utilized only with impervious waterproof floor construction (such as tile floors on concrete) and with epoxy grout. The finished urinal lip shall be flush to 3.2 mm (0.125 in.) below the floor with floor at the lip area sloped or slightly dished toward urinal. The urinal drain shall incorporate a dome (beehive) type strainer, with a 50 mm (2 in.) diameter outlet and 50 mm (2 in.) diameter p-trap of same material as building drainage system. The outlet connection shall be threaded or caulked type. The A/E shall specify that slip-joint type connections are not utilized.

## 8.2.5 Lavatories/Sinks/ Hand Sinks

For lab sinks, refer to additional requirements in [8.2.17 Lab Sinks](#).

- A. Wall-Mounted Lavatories:** Wall-mounted lavatories shall be vitreous china or stainless steel with an integral backsplash and provided with concealed carriers. Where carriers cannot be provided due to type of fixture, the fixture (not just a hanger) shall be bolted to the building structure with durable, non-corrosive hardware (typically stainless steel).
- B. Counter-Set Lavatories:** Counter-set lavatories shall be enameled cast iron or stainless steel except where integral to the countertop.
- C. Stainless Steel Construction:** Lavatories and hand wash sinks in ARF and all process areas, including food service and lab support spaces shall be constructed of stainless steel.
- D. Basin Dimensions:** The dimensional size of the basin shall in all cases be suitable for the intended purpose and to effectively capture water from use. The minimum

dimension of the open bowl area of any hand wash sink or lavatory shall not be less than 279 mm (11 in.) in length or width, with an opposing dimension of not less than 305 mm (12 in.) in length or width. The minimum vertical depth of any sink shall be at least 178 mm (7 in.) deep below the flood-level rim, except as required for barrier-free compliance. The minimum vertical depth for lavatories and dedicated hand wash sinks shall be at least 125 mm (5 in.) below the flood level rim.

**E. Design Mounting Configuration and Sealing Requirement:** Basins set in countertops/casework shall be either integral with the casework top, undermount type, or self-rimming/drop-in type. Self-rimming/drop-in type is not acceptable for areas ABSL-2 and above or for commercial food service preparation areas. Self-rimming/drop-in sinks and undermount lavatories shall be bedded in sealant before the fixture is set, and caulked again with an appropriate chemical- and mildew-resistant silicone.

**F. General Sink Requirements:** Stainless steel sinks used in cage wash areas, laboratories, and rooms subject to chemical decontamination shall be of type 316 material. Stainless steel sinks in ARFs, cage wash areas, food service wash sinks, scullery sinks and similar free-standing sinks, and wherever subject to impact shall be not less than 16 gauge; all other sinks shall be a minimum of 18 gauge. Food service sinks, including 3 and 4 compartment wash sinks and other sinks where sanitation requirements are paramount shall utilize radiused corners and shall be NSF certified or approved equivalent. Where sinks are of a free standing type and placed against building walls or partitions, they shall be appropriately fastened to structure and sealed. The use of toggle bolts and similar anchors is unacceptable. See [Section 8.2.2 Special Requirements for Stainless Steel Products](#).

**G. Counter Top Fixture Fastening Design:** Specifications for self-rimming/drop-in sinks shall require fixtures that can be securely fastened to the countertop with mechanical-type fasteners that secure the fixture basin to the deck with a screw-type clamp fastener through a channel or similar arrangement. Spring type fasteners or other fasteners relying on elasticity or use of nails are not acceptable.

***Rationale:** Screw-clamp anchorage (as opposed to self-sealing and mechanical snap clips or snap rim designs) is required to ensure water-tight seals are maintained for sanitation and to preclude damage to casework. Spring-type clips or similar elastic designs and their associated fastener arrangements have been shown to loosen and not maintain tight seals.*

**H. Sink Overflows:** Sinks for sanitary applications shall be provided without overflows, including but not limited to food service sinks, sanitizing sinks for equipment, as well as sinks otherwise subject to enhanced risk of fouling or sanitation concern.

**I. Scullery Sinks, Large Item Wash Sinks, and Similar Large Sinks and Dump Sinks:** Sinks shall be of stainless steel construction and in accordance with the following provisions:

1. **Cage Wash Areas:** Single, double, or triple compartment is acceptable. Hot and cold water is required.
2. **Food Service Areas Food Prep Sink:** A dedicated food prep/work sink, of at least 450 x 450 x 300 mm (18 x 18 x 12 in.) deep is required for food prep areas, including where beverages are prepared (except break rooms); where food is prepared, and produce is washed or food products thawed or otherwise handled in any manner requiring running water. Freestanding and scullery type sinks shall be National Sanitation Foundation (NSF) (or approved equivalent) certified. Where food prep sinks have multiple compartments, each compartment shall have a separate indirect waste to an approved receptor.
3. **Food Service Warewashing, 3-Compartment/4-Compartment and Pre-Rinse/Utility Sink:** A dedicated 3- or 4-compartment sink (wash-rinse-sanitize) or (pre-rinse/dump/scrap, wash-rinse-sanitize) with two integral drain boards is required to serve all food prep warewashing spaces, including those with a dishwasher. Where 3-compartment sinks are utilized for warewashing, an additional, adequately sized suitable utility sink of at least 250 x 350 x 250 mm (10 x 14 x 10 in.) deep is required for dumping liquids and pre-rinsing, or provision

of an approved scrapping sink arrangement is required, including where dishwashers are provided. A separate indirect waste is required for the end sanitize compartment, independent of other compartments. The wash, rinse, and sanitize compartments shall each be large enough for complete immersion of the largest equipment or utensil, but no less than 450 x 450 x 300 mm (18 x 18 x 12 in.) deep. Refer to [Section 8.4 Drainage Systems](#).

4. **Dump Sink for Utility, Food Service, Autoclave, and other General Dump Sink Applications:** Utility sinks for dumping of liquids (including beverages and blended goods) are required and shall be at least 250 x 350 x 250 mm (10 x 14 x 10 in.) deep. In food service applications, the dump sink shall be independent of 3-compartment sinks, hand wash sinks, sanitizing sinks and food service prep sinks. The utility or pre-scrap compartment of an available 4-compartment sink may be utilized in lieu of a separate utility/dump sink.

***Rationale:** A 3-compartment sink is required to ensure adequate warewashing capabilities are continuously maintained, including in the event of a malfunction of automatic warewasher and to facilitate washing of large items where required. The indirect waste of the sanitization compartment is separated to protect from cross-contamination. A dedicated pre-scrap/dump/pre-rinse arrangement is required to facilitate proper and effective washing and maintain detergent efficacy. Indirect waste of food prep sinks, including individual compartments is to protect from cross-contamination.*

***Exception:** Areas serving only food that has been pre-packaged and is served in original, unopened, sealed containers do not require provision of a 3- or 4-compartment sink.*

*This requirement does not apply to break rooms. Staff break rooms provided with a dishwasher or otherwise requiring a sink for conventional, non-food service use need only be provided with a single compartment sink of at least 450 x 450 mm (18 x 18 in.) basin dimension, with or without a disposer, and a directly connected waste.*

## 8.2.6 Faucets and Spouts

**A. Water Flow:** Laboratory and hand wash sink faucets shall provide a water flow between 5.7 and 8.3 lpm (1.5–2.2 gpm) laminar flow or aerating stream.

**B. Outlet Type:** Aerating stream faucets shall not be used for faucets in clinical areas including within the ARF. Laminar flow outlets providing a water flow of 5.7–8.3 lpm (1.5–2.2 gpm) shall be provided. Serrated tips may be furnished where necessary or requested by the program users.

***Rationale:** Laminar flow outlets provide for reduced splashing, can improve water conservation, and are appropriate to conform to health care standards for similar clinical spaces. Minimum flow is indicated to provide for efficient usage for lab operations, hand washing, and to promote effective flushing.*

**C. Faucet Actuation Types, General Requirement:** Faucets shall be actuated as appropriate for the application and to prevent cross-contamination. Water flow shall be discharged at appropriate temperature to a single (common) spout. Knob-type handles shall not be utilized.

Where only a single sink is provided in a room, faucet actuation shall be program driven and include the most stringent infection control and use requirement for the room/function served. Where only a single sink is provided to serve multiple purposes the use of wrist-blade handles along with foot pedal or sensor operation to facilitate the hands-free activation may be utilized. Where multiple sinks are located within the same space, other fixtures may be permitted to meet lesser criteria (not less than that approved for general areas of that type), provided such configuration is deemed acceptable by the Division of Occupational Health and Safety (DOHS).

The following describes faucet actuation types as required for specific space types. The term “critical” as used herein refers to spaces of elevated infection control or cross-contamination concern:

### 1. General Building Usage/General Non-Critical Hand Wash:

- a. Faucet actuation shall be wrist-blade, extended lever single control, slow-close foot pedal, or electronic sensor type as appropriate.
- b. Short lever type handles may be utilized for mechanical, janitorial, warewashing, and similar service spaces. Short lever, knob, and x-handles are not acceptable for toilet rooms or food handling areas.
- c. Where sensor faucets are utilized, they shall provide a run-time which is continuous while hands are under the faucet, or provide a cycle time of at least 15 seconds, but not greater than 60 seconds. A 15–20 second run time shall be programmed for timed faucets unless otherwise requested by the program. Listed sensor faucet run-time requirements shall be applied to all applicable fixtures.

### 2. General Lab Areas (Non-Critical Hand Wash):

- a. Wrist-blade actuation except that for cases where single-handle controls are utilized, an extended actuation lever (operable by wrist) shall be provided.
- b. Foot pedal actuation may be utilized where requested or as appropriate. Off-the floor type is preferred. On-floor mounted foot pedals are not acceptable in ABSL-2 or higher areas.
- c. Combined faucet arrangements providing a dual means of actuation (including foot pedal/wrist blade, sensor/foot pedal, and sensor/wrist-blade type dual actuation control) may also be used. In the case of sensor units, the sensor shall be arranged to preclude unintentional activation.
- d. Hands-free operation (or dual control) is preferred, but not required for ABSL-2 spaces.

### 3. Procedure, Necropsy, Tissue Culture, and Similar Critical Applications:

- a. Hands-free faucets shall be utilized (typically foot pedal type).

- b. Electronic sensor-type, hard-wired faucets are an acceptable means of actuation, but shall only be used in hand washing applications.
- c. For applications where only a single sink is provided in the room, combined faucet arrangements that provide a dual means of actuation (as indicated above) may be used with DOHS approval.

**Rationale:** In some facilities (especially existing), provision of multiple hand wash sinks may not be feasible. In such cases the most stringent actuation requirements commensurate with the cross infection control requirements for the space must be accommodated (which may be hands-free). As temperature control is necessary for other sink functions, dual means of actuation control may be required.

#### 4. Surgical Prep/Scrub Spaces:

- a. Hands-free faucets shall be utilized, knee panel actuated air-valves (preferred) or electronic sensor faucets hard wired, and fitted with either rose spray or non-aerating laminar flow outlets of at least 9.5 lpm (2.5 gpm).
- b. Wall mount (off the floor) foot pedal valves may also be utilized as requested by the program users.

#### 5. Other Critical Hand Wash Applications:

- a. Hands-free faucets (electronic sensor or slow-closing foot pedal) actuation may be utilized. The use of wrist-blade handles, including extended elbow wrist blades are not acceptable where hands-free control is mandated.
- b. Faucets with manual overrides are not acceptable. Faucets with dual means of actuation may be utilized provided all means are hands-free (i.e., foot pedal/sensor) configuration.
- c. Sensor faucet with sensor type temperature control may be used provided the faucet meets all other requirements of this section.

Where a constant, user controlled flow is required, utilize pedal valves.

- d. Where pedal valves are utilized, the mounting configuration shall be appropriate to the cleanliness and infection-control requirements of the space.

**Rationale:** Wrist-blade controls are susceptible to cross-contamination. Wrist-blade overrides are not acceptable for areas where hands-free only operation is mandated by DOHS or otherwise necessary to ensure adequate cross-infection control (such as BSL-3 and surgical areas). Knob, X-handles, etc. are undesirable due to requirements to grasp handles after cleaning hands.

**D. Spout Type, Height, and Vacuum Breaker:** Faucets in laboratory and ARF areas shall be provided with gooseneck or high-rise-type spouts with an integral atmospheric vacuum breaker. Hand wash sinks shall be provided with gooseneck or high-rise spouts and shall include an integral atmospheric vacuum breaker wherever such fixtures are located in labs, animal holding rooms, or where otherwise subject to plausible use that may induce backflow. The spout outlet shall in all cases be at least 130 mm (5 in.) above the fixture flood rim. Vacuum breakers are required to protect the integrity of the serving water supply, which even in the case of isolated lab water systems must be protected.

**Rationale:** Gooseneck/high-rise spouts provide for a substantial air gap to clear tall items, maximize usability of the sink, and to minimize potential contact or submergence with the faucet outlet with in-sink vessels. Vacuum breakers are required to protect the integrity of the serving water supply from backflow through presence of point of use high hazard level backflow protection.

**E. Faucet Spout Configuration and Reach:** The A/E shall coordinate faucet and sink selections to ensure that appropriately sized spouts are provided for each sink. Faucet spout reach shall be appropriate to sink size and function. The spout shall be swing or rigid type as suited to the application. Spouts shall extend into the basin past the back wall of the sink to provide



a clearance of at least 125 mm (5 in.) from the sink back wall to the center of the flow stream, but shall not extend more than approximately 1/2 to 2/3 of the width (front to back) of the sink basin, and shall maintain at least 150 mm (6 in.) from the front edge of the basin to the flow stream. Spouts for general labs shall be convertible between rigid and swing spout configuration and installed per the requirements of the program. Spouts on small sinks (such as small hand wash fixtures and lavatories) should typically be fixed (rigid) type.

**F. Serrated Tips:** The A/E shall coordinate with the program to determine which faucets shall be fitted with serrated tips. Hand wash faucets shall not utilize serrated tips but shall instead be fitted with laminar flow outlets.

*Rationale: Serrated tips are not required at all faucets and are not suitable for faucets that are used for hand washing due to excessive splashing.*

**G. Temperature Control:** Water supply to sensor-activated faucets shall be tempered at the point of use, with a thermostatic valve provided at the fixture-supply connection, and individual to the fixture being served. Circulation of tempered water remote from the use point is unacceptable. The set point of faucets for hand wash purposes providing single temperature water shall be 40°C (104°F), except where otherwise approved. Refer to [Section 8.3 Water Systems](#) for additional criteria. In lieu of provision of tempered water at the use point, provision of hands-free temperature control is acceptable by one of the following methods:

1. Use of dual (hot/cold) foot pedal valves integrated with the sensor faucet (or)
2. Provision of an approved hands-free-type electronic sensing mixer arrangement (such as an infrared sensor); provided the sensor automatically defaults to a safe tempered position after each use, has been properly calibrated to activate only upon proximity detection placed directly in front, and not to exceed a distance of 150 mm (6 in.) from the sensor(s), is compatible with room lighting, includes a suitable and clear visual and intuitive display of temperature condition and sensor operation, and is controlled by a thermostatic mixing valve. The set tempered position shall be of a secure (pass code) or mechanical

fixed position lockable type to prevent inadvertent or unauthorized adjustment.

**H. Electronic Sensor Faucets:** Where electronic sensor faucets are utilized, they shall be hard wired and on standby power, except as noted in this section. The A/E shall specify all sensor faucets to be adjusted for proper operation to avoid false activation, and ensure cycle times are in conformance with requirements of this section. Sensor faucets with manual controls allowing the user to manually touch the temperature adjustment control (whether or not a temperature adjustment is anticipated) shall not be considered as “hands-free.”

**I. Ceramic Valving:** Where two-handle manually activated faucets are utilized, ceramic-type faucet valving with brass or stainless steel internal components shall be provided.

*Rationale: Ceramic valve faucets ensure consistent positive shut-off and are less prone to eventual leakage and maintenance issues.*

**J. Restroom Lavatory Faucets:** Electronic hands-free faucets with high-arc, medium-arc, or gooseneck spouts (provided bottom of outlet is at least 100 mm (4 in.) above sink flood rim, and hard wired power shall be provided for lavatories in restrooms serving public and staff areas. Automatic faucets serving restroom lavatories shall be rated for a water flow rate of 3.8–5.7 lpm (1.0–1.5 gpm), and the cycle time shall maintain water conservation at not more than 1 liter (0.25 gallons) per cycle or to run only while hands are continuously present under the spout, but not greater than 60 seconds. Faucets shall have a time-out feature to preclude continuous running in the event of a blocked sensor. In applications where manual-faucet operation is accepted on a case-by-case basis (non-sanitary, non-food service areas, and not for toilet rooms serving food service areas), wrist-blade actuation is required with a flow rate of 1.9 lpm (0.5 gpm).

**K. Food Service Hand Wash:** Electronic hands-free faucets with high-arc or gooseneck spouts (outlet at least 125 mm [5 in.] above sink flood rim) and hard wired shall be provided for dedicated hand wash sinks and lavatories in restrooms serving food service areas. Faucets for hand washing in food services shall provide a flow rate of at least 5.7 lpm (1.5 gpm), shall be set to provide a delivery temperature of 40°C (104°F) and shall run for at least 15 seconds (not more than 60 seconds) per

cycle unless knee-valve/foot pedal actuation is provided or determined unacceptable by the health/food safety official. Knee valve and foot pedal hand wash sinks may be utilized in lieu of sensor faucets in food prep areas where fitted with a thermostatic mixing valve to deliver single temperature water in accordance with requirements of this section unless precluded by barrier free requirements.

## 8.2.7 Foot Pedal and Dual Actuation Valves

**A. Arrangement and Coordination With Construction and Casework:** Where foot pedal valves are required, they shall be arranged to mount above the floor in casework or above the floor on anchorage brackets attached to the building wall structure and in the case of wall mounting, shall be provided with extended (long) fold-up pedals. On-floor mounting is generally not desirable, but may be accepted for BSL-2 or less (not ABSL-2) areas. All pedals shall flip up for cleaning. Where pedals mount within casework, the A/E shall coordinate specifications to ensure the casework manufacturer prepares cabinets for proper mounting, reinforcement, and cut-out for the foot pedal operation and to facilitate flip-up of valve pedals. In all cases, pedals shall be arranged as to allow servicing of the pedal valve and to maintain pest control requirements. The arrangement of the valve and associated piping shall present a finished installation free of sharps hazards. The mounting surface shall be sufficiently reinforced or provided with an anchorage assembly and backing plate for receipt of the foot pedal valve and to prevent displacement. Valves shall be anchored to structure with stainless steel hardware and metal anchors, or to the cabinet base with stainless bolts and nuts.

***Rationale:** Mounting above floor promotes cleanability; while preferred, it is not automatically required for BSL-2 laboratories.*

**B. Pipe Connections:** Piping connections into and out of foot pedal valves shall be flared, threaded, soldered, or double ferrule (Swagelok) type. Compression joints shall not be utilized as tubing connections into and out of foot pedal valves.

***Rationale:** Connections must be resistant to abuse and vibration typical of foot pedals without leakage or ongoing maintenance issues.*

**C. Penetrations in Casework:** Penetrations through casework shall be factory cut and finished, or otherwise arranged to ensure smooth, sealable surfaces, free of sharp edges.

**D. Dual Actuation, Separate Isolation Valves:** Where faucets include multiple means of actuation (such as both hand and foot pedal operation), separate isolation valves shall be provided for the foot pedal valve to facilitate maintenance.

**E. Location:** Foot pedal valves shall be located so as not to pose a trip/fall hazard.

## 8.2.8 Battery-Powered and Self-Sustaining Automatic Faucets and Flushometers

**A. Acceptance Criteria:** The use of hard-wired fixtures is preferred over battery-powered fixtures. Battery-powered fixtures will only be accepted subject to conformance with the following:

1. The application is only for a conventional public toilet room or non-critical application. It shall not be used for hand wash sink(s) in a laboratory, ARF, biocontainment area, clinical area, safety fixture, food service, or other critical application.
2. The installation is made as a replacement/renovation where walls/ceilings are not opened or it would be impractical to provide electric hard-wiring.
3. The fixture power supply shall be either a hydropower- (turbine) type self-sustaining unit, lithium-type battery, or both. The use of solar-charged batteries with lenses integrated locally with the faucet or flushometer, or any battery configuration that will not achieve at least a 2 year service life under demand conditions of not less than 4,000 cycles per month are not equivalent.



4. Failure of a battery shall only result in failure of a single served fixture. The use of ganged battery supply in lieu of hard-wire AC power is not acceptable.
5. In the case of water closet and urinals, the flushometer shall include a manual flush bypass configuration that operates without battery power to allow for continued flushing in the event of loss of the power supply.

## 8.2.9 Showers

**A. Control Valve Type:** Shower control valves shall be ASSE 1016 thermostatic or combination thermostatic and pressure-balance type. Shower controls that are of the pressure-balance only type will be permitted for applications where the upstream hot water supply includes duplex ASSE 1017 master thermostatic mixing-valve assemblies (arranged in parallel) to provide continuous thermostatic protection throughout the flow range.

*Rationale: These arrangements provide scald protection for users.*

**B. Temperature Limits:** Maximum outlet temperature at showers shall be limited to 45°C (112°F) at the individual fixture limit stop. Shower valves shall be institutional grade, rotating through cold to hot with an Architectural Barriers Act Accessibility Standard (ABAAS) compliant lever handle. Faucet trim, levers, and escutcheons shall be constructed of stainless steel or chrome-plated brass, and all shower valves shall include check stops.

**C. Flow Rate:** Showers shall be rated for a water flow of 10 lpm (2.5 gpm). Ultra-low flow showers of at least 8 lpm (2.0 gpm) flow-rate type will be permitted only where the water heating source and control valves incorporate adequate control valves (such as ASSE 1016 combination type T/P) rated for the reduced flow rate.

*Rationale: Many ultra-low flow showers result in increased shower times, decreased throughput, and may increase scald hazards.*

**D. Shower Base, Safing, and Drains:** All showers shall be provided with a floor (base) that includes a positive slope toward the drain. Where showers are built in-place (unless epoxy coating system over masonry construction), provide an ANSI A118.10 polyethylene/chlorinated polyethylene (CPE) sheet membrane min. 0.8 mm (0.03 in.) thick with integral plastic bonding fleece over pre-sloped masonry and per ANSI A108.13, thin-set method. Avoid and minimize seams. All built-in place applications shall be provided with commercial grade ASME A112.6.3 drain that includes a membrane flange clamping device and weepholes for positive drainage below the floor, and an arrangement to maintain membrane slope and unblocked weepholes. Bonding flange drains that do not use both clamping collars and weepholes are unacceptable. Curbless shower installations require the use of a waterproof membrane for the entire floor. Lead shower pans and plastic shower bases are unacceptable. A 24 hour membrane flood test to curb height (prior to finished surface installation) is required.

*Rationale: CPE membrane material is for long-term durability. Plastic shower bases do not maintain durability and have been subject to premature failure. For long-term reliability, membranes should allow for positive drainage, not just evaporation of moisture through the finish surface (which can be impeded by sealers, some grouts, and grouting failures). Thin-set surface membranes minimize fouling within the bed; however, the unbonded thick-set approach may be advantageous where subject to potential cracking.*

**E. Shower Base Floor Penetration Sealing:** The A/E shall ensure that the drain penetration through the floor slab is appropriately detailed in drawings to be properly sealed, and not reliant just upon caulking around the external fixture base.

**F. Shower Trim:** Where hand showers are provided trim shall be for institutional use and all hangers and slide bars shall be securely anchored to the building structure. The inlet hose serving hand showers shall include an ASSE 1014 backflow preventer or vacuum breaker mounted to the wall.

*Rationale: Slide bars and attachments may be utilized as grab bars or otherwise subject to abuse. These provisions ensure sufficient durability.*

**G. Shower Wall and Base Materials:** Shower walls and bases shall be constructed of durable, impervious materials. Unless constructed of multipart epoxy over masonry construction, the use of ANSI A137.1 impervious class porcelain tile floors with epoxy or sanded, mildew resistant grout is recommended, and floor finish shall have a wet coefficient of friction greater than 0.75. Stainless steel and epoxy-coated cement non-slip bases may also be used. Unless epoxy coating systems are used, walls shall be provided with an ANSI A118.10 sheet applied, non-woven, plastic fabric reinforced polyethylene or liquid applied membrane system just below the finish surface.

*Rationale: Impervious grade heavy duty tile is used for durability and epoxy grout is preferred due to imperviousness, mold, and chemical resistance.*

## 8.2.10 Emergency Showers and Eyewash

**A. Water Supply:** For requirements regarding the arrangement of water supply systems serving emergency fixtures see Section 8.3 Water Systems.

### 8.2.10.1 Emergency Fixture Location

**A. Availability:** At least one emergency shower and eyewash shall be available to serve each laboratory space/area where hazardous materials are handled (such as a chemical fume hood, chemical storage, and other similar activities), corrosives, and other areas in accordance with 29 CFR 1910.151 and ANSI Z358.1. Eyewash/facewash fixtures shall not be located where likely to be contaminated (e.g., adjacent to animals). Locations should be determined during lab planning phase and are subject to approval of DOHS.

**B. Required Emergency Fixture Locations:** Emergency shower and/or emergency eyewash fixtures shall be provided in cage wash areas nearest to the location where chemicals are handled and dispensed, medical/pathological waste areas, effluent/pH treatment rooms, and shall be available to serve laboratories where chemical

or biological materials are handled, hazardous material and chemical storage areas, at each animal holding room and mechanical space where a hazard may be reasonably anticipated, and at other areas where hazardous chemicals biological hazards, or airborne particle risks may be present. Emergency fixtures for spaces operating at BSL-3 and above shall be in accordance with that section of the *DRM*.

**C. Quantity in Labs:** The A/E shall, in consultation with the program staff, consider the need to provide an eyewash fixture at each lab sink or multiple lab sinks or locations versus placement at only a main sink in each lab as deemed appropriate for the application and potential risk.

**D. Activation Flow Alarm:** In spaces where a significant hazard exists and it is likely a user may be present without supervision, a flow alarm shall be provided to indicate emergency shower operation. The alarm shall provide local audible alert and remote alert. Locations where this may be necessary shall be determined through discussions with the NIH users and DOHS, and should generally include areas such as chemical storage and pH treatment system rooms.

**E. Electrical Hazards:** Emergency fixtures shall be located so as to be clear of electrical hazards, including spray patterns while in operation.

### 8.2.10.2 Emergency Fixture Equipment Requirements

**A. Fixture Type:** All laboratory safety equipment shall meet the requirements of ANSI Z358.1 and OSHA safety and health standards. Emergency shower and eyewash fixtures shall be of the on-off type, operable with a single hand under partially distorted vision.

**B. Emergency Showers Additional Provisions:** Emergency Showers shall comply with the following additional provisions:

1. Where concentrated corrosives and large volumes of chemicals are utilized (such as showers serving chemical storage rooms, pH effluent treatment areas, and other high hazard areas), high-flushing 114 lpm (30 gpm) emergency showers shall be provided. Flow rates of 76 lpm (20 gpm) are acceptable for conventional applications.

Fixture activation in lab areas and serving lab areas shall be recessed type (such as recessed-wall actuating handles) or arranged such that control activation rods are clear of traffic areas and not subject to accidental activation.

Pressure-compensating flow-rate controls shall be provided to limit flow to not exceed within 120% of the required fixture flow rate.

**Rationale:** This is to both minimize flooding and risk of a single unit “starving” the system, including supplies to other emergency fixtures that could be required in simultaneous use under certain accident scenarios.

Wherever possible, floor drains shall be provided to serve emergency shower fixtures (including fixtures in corridors, mechanical rooms, etc.) except as follows:

- a. Floor drains are not permitted in conventional lab areas. Floor drains shall not be provided for emergency showers that must be located within conventional labs.
  - b. In existing construction where drains cannot be physically installed at a location where an emergency shower is required, a variance shall be submitted for the Division of Technical Resources (DTR) review, documenting reasons that adequate drainage cannot be appropriately installed or located effectively nearby.
2. Floor drains shall be fitted with automatic electric trap seal primers.

**Rationale:** Floor drain use is not justified for fixtures not subject to frequent use such as in emergency showers in research areas of biomedical laboratories. Shower testing may be carried out with portable testing apparatus. In areas where potential for usage is elevated (such as cage wash and areas where substantial corrosives are routinely handled), provision of floor drains may be justified to facilitate clean-up and minimize water damage.

**C. Emergency Eyewash Additional Provisions:** Screens/filters and flow regulator arrangements shall be provided and should ideally be serviceable at the fixture heads (above the deck) and shall not require piping system disassembly or routine replacement. Such components shall be configured to permit quick servicing. Pressure-reducing valves shall be provided only where necessary. All eyewash (and facewash) fixtures shall be provided with a means to collect water spilled during use and testing and to channel such water in a code-approved manner into the drainage system without inducing damage to the facility or spread of water beyond the immediate fixture use area. The minimum flow rate of eyewash or eye/face wash fixtures shall be 9.46 lpm (2.5 gpm) per fixture.

1. Where eyewash fixtures are provided at sinks, they shall comply with ANSI Z358.1 position requirements and usability in a hands-free mode for users of varying height and they should be selected and arranged so as not to conflict with sink operating controls or usable lab bench space.
2. In selecting and locating emergency eyewash fixtures, the A/E shall consider the required mounting and operating position of fixtures to ensure effective capture of the flow stream during operation and testing.
3. Eyewash fixtures shall not be built into or attached to laboratory faucets. Where such devices are encountered in renovation projects, they shall be removed and emergency fixtures provided per the DRM.

**Rationale:** Spout end-mounted fixtures are not ANSI Z358.1 compliant hands-free fixtures that are operable with single-step activation, allow proper temperature control, and would not be subject to supply from lab water system or potential of contamination on the downstream side of the backflow preventer (BFP).

The following additional requirements, specific to individual eyewash type shall be met:

- i. **Vertical Pull-Down, Sink/Casework Type (Preferred Type for In-Lab Use):**
  - Unit location and configuration shall

be coordinated with sink-basin size and faucet handle position to ensure proper operation and that streams are contained within the sink basin. Offset-type units or single head-dual stream units may be required to clear faucet wrist blades and accessories and ensure capture of flow streams.

- Unit shall turn on and shut off by single action pull-down/rise-up motion of the fixture, with the water flow to start on descent and stop on ascent at no more than a 30 degree angle from the horizontal (full open) position.

**Rationale:** These units are preferable for in-lab use as they ensure that water flow during routine testing and operation may be contained within the sink basin and not spray or excessively drip onto casework. This type unit is cost-effective, minimizes maintenance, does not impede on deck space, and avoids backflow preventer issues.

ii. **Horizontal Swing-Away Sink/  
Casework Type:**

- Unit shall turn on and shut off entirely over sink basin. Swing-over, single-motion automatic operation (turns on when swung horizontally over basin, turns-off when swung away) are preferred; however, paddle-actuation may be used.
- Swing-away type units shall be selected with approval of the program users to confirm acceptance of placement.

iii. **In-Wall, Recessed Pull-Down Panel-Type Units:**

- Unit shall include an adequately sized catch-pan.
- The catch-pan shall be piped to spill indirectly to an automatic electric

trap primed floor drain, and is therefore not located within the lab. The configuration of the piping and outlet connection for the pan shall be such as to minimize exposed piping.

a. **Drench-Hose Type**

- Drench-hose-type units, if provided, must meet all additional requirements of this subsection.

**Rationale:** Drench hose units can offer flexibility including the capability to spray water on body areas where an emergency shower may not be present. However, a number of plumbing code issues, ANSI standard issues, usability and fixture position issues restrict their cost-effective installation in full compliance with all legal requirements. Significant on-going maintenance is necessary to maintain and replace required point of use backflow preventers on a routine basis that are otherwise not required with other fixture selections.

- Placement must allow for users of varying height to properly operate the fixture in a hands-free mode, and should also preserve lab bench space. Units placed in the far back of the casework may not comply with these requirements.

Deck-mount units must be positioned to facilitate fixed eyewash usage, with spray directed toward the basin. Wall-mount units must be located at a suitable ANSI Z358.1 compliant height and to adequately stand-off from the wall to permit hands-free use, and be positioned in a manner that use is not blocked by casework or other impediment.

- Emergency fixtures shall not be planned as a means for routine or intermittent hose-supplied water. Such fixtures shall be for emergency usage only.

The unit shall incorporate appropriate backflow prevention at the point of use, be fully compliant with code and the listing requirements of the backflow prevention device for the pressure condition, valve position, and hazard potential served. Compliance with one of the following is required:

- The unit shall be a paddle-type actuated unit, which includes an ASSE 1001 atmospheric vacuum breaker mounted with the critical level at least 150 mm (6 in.) above the deck (or on the wall) and on the discharge side of the actuator, but on the inlet side of the hose. This is the preferred approach where drench hoses are used due to minimal maintenance, (or)
- The unit shall incorporate a spill-resistant pressure vacuum breaker (ASSE 1056) as part of the individual fixture or individual fixture installation, upstream or downstream of the actuating valve, which must be accessibly located and installed per the device listing, (or)
- The unit includes an ASSE 1011, ASSE 1012, ASSE 1019, ASSE 1035, ASSE 1052, or CSA B64.3 backflow preventer that is located on the discharge side of the actuating valve, but at the inlet side of the fixture hose, and is positioned such that any spillage will go into the sink or other area where damage will not occur should routine spillage occur, and is accessible for service/replacement, (or)
- The unit includes an ASSE or FCCHR listed backflow preventer, installed in accordance with its listing, which has been certified by the manufacturer to be suitable for continuous-pressure application on the upstream side of the actuating valve, including for use with high hazard back siphonage applications, is located on the inlet side of the fixture hose, and is further certified to be spill-resistant

(not require placement over a sink or drain), and is accessible for service/replacement.

*Rationale: Drench hose fixtures can be subject to backflow cross-connections and submergence of the spray head. The backflow preventer approaches provided with many drench hose units do not meet the requirements of plumbing codes or the listing requirements of the backflow prevention devices (including allowable pressure condition) and are typically left to local authorities to identify the compliance issues and associated risks.*

#### b. Alternative Eyewash/Facewash Types:

- i. Fixed basin units that are hard plumbed with electric trap seal primers, freeze-proof units, and other ANSI Z358.1 and plumbing code compliant fixtures may be utilized outside lab areas subject to NIH approval. Where approved, stainless steel fixed-basin type units may be used in labs or to serve lab areas, provided they include an electric trap seal primer (e.g., no sink near to where the fixture would be required and the basin is securely attached to the structure).

## 8.2.11 Janitor Sinks/Mop Sinks/Janitor Closets

**A. Mop/Service Sinks:** Janitor mop sinks shall be constructed of enameled cast iron, terrazzo, or stainless steel and shall be fitted with drains and traps of at least 75 mm (3 in.) diameter. The faucet shall be provided with a vacuum breaker. Sinks rims not over 300 mm (12 in.) high are preferred where mop buckets will be emptied.

*Rationale: Plastic units do not maintain durability and are subject to cracking, leakage, and displacement.*



**B. Drain Penetration Through Floor:** The A/E shall ensure that the drain penetration through the floor slab is appropriately detailed in drawings to be properly sealed, and not reliant just upon caulking around the fixture.

**C. Wet Area Penetrations:** The A/E shall coordinate among disciplines to ensure appropriate sealing of penetrations and integrity for wet areas as will occur routinely in janitor closet spaces.

**D. Floor Drains:** Floor drains are not required in janitor mop sink closets and should only be used if justified.

*Rationale: The drain penetration to mop sinks through the floor is completely concealed once the fixture is set, and often is not well sealed. Water damage and disruption to program areas below may occur due to routine wetting of floors that occurs at these locations.*

## 8.2.12 Drinking Fountains and Bottle Fillers

**A. Fixtures:** Provide drinking fountains accessible to all occupants as required by code, on each occupied floor. Bottle dispensers and fillers shall not substitute. Drinking fountains and bottle fillers shall not be located in lab areas.

**B. Water Dispensers:** The A/E shall consider provision of arrangements for the filling of water bottles for public and staff. Water dispensers shall not be a substitute for code-required accessible-drinking fountains and shall not require reliance upon a container or an available supply of drinking cups. Restaurant style glass/pitcher fillers may be used. Regardless of type, water dispensers shall spill over a receiving drain capable of catching any drips and overflows while filling or in the event of leakage.

**C. No Additional Filtration:** Drinking water fountains, water coolers, and water dispensers shall be provided without filtration arrangements and shall dispense only untreated potable water.

**D. Electric Chilling:** Units may be provided with non-centralized electric chilling located at or immediately

adjacent to the point of use.

**E. Construction and Mounting:** Units shall be constructed of stainless steel, and shall be of the wall-mounted type with durable, in-wall carriers, mounting frames, or other durable means of attachment direct to the building structure and capable of withstanding leaning, pulling, and standard misuse of such fixtures.

*Rationale: Water dispensers assist with sustainability targets by reducing waste associated with plastic bottles. The use of taste/odor filtration imposes a maintenance burden which can potentially result in compromised water quality. Individual users may more appropriately supply and maintain their own bottles with integral filters.*

## 8.2.13 Hose Bibb/Hydrants

**A. Required Locations:** Hose bibb/hydrants shall be provided within mechanical equipment rooms, kitchens, loading dock areas, accessible/flat roof tops, within or adjacent to planters for watering, and where necessary for maintenance and cleaning. Hose bibbs in public areas shall utilize common loose key enclosure boxes or loose key operators.

**B. Wall/Yard Hydrants:** Wall or yard hydrants shall be provided outside the building to accommodate landscape watering, pavement/sidewalk cleaning, and loading dock clean-up.

**C. Freeze-Proof Design:** All exterior hydrants shall be of a freeze-proof design with the valve seat located inside the heated building, on the heated side of building insulation.

**D. Backflow Protection:** All hose bibbs/hydrants shall be provided with integral, repairable, or replaceable hose bibb vacuum breakers, and shall be self-draining type where subject to freezing. Compliance with ASSE 1019 (Type B) is required for exterior units. Interior units shall meet ASSE 1019 or ASSE 1011. The use of externally applied hose bibb vacuum breakers that upon removal would leave hose threads, or from which removal would damage the device (e.g., lock screw type) is unacceptable. Only integral-type devices (whereas



removal would render the device inoperable or preclude hose attachment) may be used.

## 8.2.14 Waste Disposers

**A. Construction:** Waste disposers shall utilize stainless steel grind chambers (except that cast iron or cast aluminum commercial grade grind chambers may be used in non-lab areas); shall be continuous feed type with appropriate-size chamber, rotor, and motor for the application; have a cast (not forged) nickel-chrome sizing ring; be jam-resistant design with stainless steel or ductile iron rotor; and have a reversing motor of at least  $\frac{3}{4}$  horsepower (HP).

**B. Grade Units:** Where used with conventional sinks (90–100 mm [3.5–4 in.] outlet hole) for light-duty applications (such as break rooms), the use of light duty commercial  $\frac{1}{2}$  HP models meeting these requirements, or  $\frac{3}{4}$  to 1 HP premium residential-grade units of stainless steel construction with automatic reversing design may be utilized. Residential-grade disposers are not acceptable for lab areas.

**C. Restricted Use:** The use of disposers in any lab area shall be subject to review and approval of the the Office of Research Facilities (ORF) and DOHS. Such disposers may be permitted for specialized program needs such as aquatics or animal food prep areas and shall not be used for disposal of infectious waste. The use of disposers in commercial food service shall conform to requirements in [Section 8.4 Drainage Systems](#). Disposers shall not be installed in the wash compartment of 3-compartment sinks; an additional compartment, additional sink or waste cone is required.

**D. Staff Break Rooms:** A disposer shall be provided where a refrigerator, microwave, or similar equipment are located unless otherwise directed.

## 8.2.15 Dishwashers

**A. Community Kitchen/Semi-public and Break Room Type:** Dishwashers for limited or small-group use which are not intended as part of central food service or for a

commercially defined food service establishment shall be NSF/ANSI 3 approved or specially designed for such use without chemical sanitant. They shall have a sanitizing final rinse at a temperature of at least 74°C (165°F). NSF/ANSI 184 dishwashers may be utilized for non-public applications where the use of the sanitize cycle may be ensured, provided such dishwashers are not serving the public or highly susceptible populations. In no case shall dishwashers be selected which cannot maintain a wash temperature of 60°C (140°F) and a sanitizing rinse cycle of at least 66°C (150°F). NSF-184 dishwashers are not acceptable for highly susceptible populations as defined in the FDA Food Code, e.g., daycare, elderly, and immuno-compromised applications. Semi-commercial/employee break-room type dishwashers are available from some manufacturers for light commercial, office, and communal kitchen applications, including models with conventional, residential-style wash racks. An above-counter air gap fitting shall be provided on dishwasher drains unless served by an unconcealed floor sink.

**B. Commercial-Type:** Commercial dishwashers shall be listed to NSF/ANSI 3 and shall be hot water sanitizing type. Refer to [Section 8.4 Drainage Systems](#) for requirements related to drain tempering and drainage configuration. The use of commercial dishwashers is mandatory for all applications as required in the FDA Food Code.

**C. Sanitization:** The use of hot water sanitization from local booster heaters is generally preferred over chemical sanitization, and shall be used for all applications where feasible and for all new construction projects. Chemical wash equipment shall not be located in areas where chemicals may be accessible to public.

***Rationale:** Residential dishwashers which meet ANSI 184 depend upon application, proper use, and uninterrupted operation of the sanitization cycle for effective dish sanitization. For commercial dishwashers (including rack and undercounter type), the use of hot water is preferred to avoid on-going chemical monitoring and maintenance of chemical supplies, operating cost and cleaning efficacy.*

## 8.2.16 Lab and Animal Research Facility Equipment

**A. Lab Equipment (Regardless of Whether Specified as Plumbing Items or as Lab Equipment):** shall meet the requirements of [Chapter 8: Plumbing Design](#) and [Chapter 12: Special Process Piping Systems](#). The A/E shall coordinate internally to ensure conformance. Lab fittings and fixtures shall meet or exceed the SEFA-7 standard, except where any provision conflicts with DRM requirements.

## 8.2.17 Lab Sinks

**A. Materials and General Requirements:** Sink materials shall be corrosion resistant, smooth, and impervious and shall be integrated flush or below the the bench top with epoxy or equivalent sealed seam-minimized sanitary arrangements and to avoid exposed, unfinished surfaces. Basins of epoxy resin, phenolic resin, or (where appropriate) stainless steel of not less than 316L grade may be utilized. Materials selection shall be made in consideration of required chemical resistance. Stainless steel is required for aseptic spaces. Where wall-hung sinks are used in wet ABSL areas (including clean and dirty cage wash areas), they shall be 316 stainless steel. Refer to additional requirements for sinks/handsinks/lavatories and [Section 8.2.6 Faucets and Spouts](#). Refer to [12.1.6 Distribution Systems: Common Requirements](#) for requirements for high purity water outlets.

**B. Drains and Trim:** Drains and trim shall be of approved corrosion-resistant material. The A/E shall coordinate the specification of trim (faucets and drains) serving lab sinks with the requirements of this section.

**C. Accessible Shut-Off Valves:** The A/E shall coordinate the rough-in requirements of water supplies such that shut-off valves are accessible.

**D. Lab Sink Depth, Plumbing Location, and Casework Coordination:** Sink depth and casework shall allow for installation of a vertical sanitary tee- (T-) or wye- (Y-) fitting into the tailpiece to serve indirect waste as required for current or future conditions. In general, there shall be a minimum clearance below the bottom of the sink of at least 406 mm (16 in.) and preferably at

least 457 mm (18 in.) to the shelf, casework bottom, or other horizontal surface that would limit clear space.

**E. Sink Drain Type:** Refer to [Section 8.2.25 Fixture Trim Requirements](#).

**F. Lab Sink/Lab Warewasher Coordination:** The A/E shall coordinate the drain rough-in requirement to include the installation of a Y-fitting in the tailpiece to serve an adjacent undercounter labware washer where either such items are provided, or to provide for other indirect waste connection for bench top equipment where required. The arrangement must allow for the T/Y fitting to be vertically installed on the drain tailpiece, along with the necessary sink drain adapter, all at the inlet of the P-trap, and to clear any lab shelving and depth of the lab sink.

*Rationale: Laboratory undercounter washers require indirect waste connection to sink tailpieces, whose rough-in (in-wall plumbing) must be at the proper height and properly detailed. Other configurations, including provision of dedicated traps have been problematic and are generally unacceptable.*

## 8.2.18 Labware Washers and Autoclaves

**A. Break Tank and Integral Air Gap Backflow Protection:** Where labware washers and similar equipment require a high purity water rinse, the preferred approach for connection of the purified water is to specify units that include a built-in air gap (such as units constructed in full conformance with ASSE 1006) or alternatively with a break tank option with suitable overflow protection rather than direct connection to the building purified water system. These approaches are also preferred for the hot and cold water supplies to labware washers as they preclude need for additional point of use backflow protection.

*Rationale: Break tanks and air gaps avoid potential backflow issues and dead-legs which degrade quality water systems.*

1. **High Purity Water Break Tank Configuration:** Break tank arrangements are normally manually filled for each batch and routinely cleaned or replaced. If automated, the arrangement must include suitable overflow protection.
2. **High Purity Water Direct Connection:** Where the break tank or integral air gap option is not available, a BFP and arrangement to minimize dead-leg is required. Refer to [Section 12.1 High Purity Water Systems](#).

**B. Warewasher Waste:** The drain of undercounter-type labware wash units shall be routed to the inlet tailpiece of an adjacent lab sink P-trap. Where an adjacent lab sink is not provided a stainless steel in-wall drainage outlet box with a 50 mm (2 in.) outlet to receive the labware washer waste and an automatic electric trap seal device shall spill with a visible air gap through the waste-outlet box. The height of the box shall be coordinated with manufacturer requirements and located in the open room where the equipment is located (not concealed within casework).

**C. Drainage Configuration:** Equipment outside of laboratories may spill to floor sinks or funnel-type floor drains connected to the lab waste system, except that autoclaves may connect to the sanitary system in some conditions. Refer to [Section 8.4 Drainage Systems](#). The drain hose from the warewasher shall loop and be fastened high to the undersurface of the bench top, unless not required (such as for gravity-discharge units spilling to a floor sink).

**D. Water Hammer Arrestor(s):** Properly sized water hammer arrestor(s) shall be provided and appropriately located on the supply to the unit upstream of the quick-closing valves, but after any backflow preventers.

**E. Autoclaves/Sterilizers:** Additional requirements specific to autoclaves/sterilizers are addressed in [Chapter 4: Architectural Design](#); [Section 8.3 Water Systems](#); [Section 8.4 Drainage Systems](#); and [Section 8.6 BSL-3 and ABSL-3 Biocontainment](#).

---

## 8.2.19 Incubators

**A. Manual vs. Automatic Type Filling:** Where high purity water is required for incubators, manual filling of tanks or trays is preferred.

**B. Break Tank Arrangements:** See [Section 8.2.18 Labware Washers and Autoclaves](#) for requirements.

**C. Point of Connection Filter:** Specification to include the manufacturer's recommended in-line gas filter should be provided at the point of connection.

---

## 8.2.20 Fume Hoods and Biological Safety Cabinets

**A. Fume Hood Vacuum Breakers:** Fume hoods with water connections shall include an ASSE 1001 atmospheric vacuum breaker mounted high, exposed on the exterior of the hood. This shall be coordinated with the hood manufacturer. Faucets with internal backflow preventers or internal hood vacuum breakers are unacceptable.

**B. Internal Equipment Piping Materials:** Piping materials used within the lab equipment shall be suitable for the grade of service. Threaded iron is required for fuel gas. Copper or stainless steel is required for other services, which shall be brazed, welded, or double-ferrule-type (e.g., Swagelock) connections only. Soldered joints and mechanically pressed joint connections may be used for water. Compression joints are not acceptable for any service.

**C. BSC's Utility Restrictions:** Generally, only lab vacuum is permitted to be piped to biological safety cabinets (BSCs). CO<sub>2</sub> is acceptable for limited applications subject to DOHS approval.

**D. Utility Turrets:** Comply with requirements for Lab Gas Turrets.

---

## 8.2.21 Lab Gas Turrets

**A. Turret Identification:** Turret types shall be clearly indexed for the service.

**B. Backer Plate:** A backer plate or other suitable arrangement should be provided to protect wall construction that may be subject to damage associated with pipe movement or stresses (i.e., drywall). The backer plate should be preferably of stainless steel or other

substantial, cleanable, corrosion and moisture resistant material, and with smooth, rounded edges properly sealed to construction.

**C. Natural Gas/Fuel Gas Turrets:** Turrets for natural gas shall be listed to appropriate standards for the application and for the type of fuel gas.

**D. Vacuum Service Turrets:** Turrets shall be ¼-turn ball type, designed for vacuum service, except where the use of needle style valves are requested by the program. Turrets shall be of suitable type for the system vacuum level and designed to seal tight with the level of system vacuum (typically in the range of 610 to 700 Torr [24 to 27.5 in. Hg {gauge}] pressure).

**E. Threaded Serrated Outlet:** All turrets shall include a removable-type serrated tip. Serrated tips that are integrated with the service cock/turret and cannot be unscrewed (even with tools) without removing the entire valve are unacceptable. Standard threads (such as NPT type) are required.

***Rationale:** Needle valves may not open sufficiently or easily for common use, and should therefore only be used where precise regulation is required or specifically requested by users. Regulators and needle valving can be applied downstream of quarter turn turrets at specific connections as necessary, and is preferable to restricting all users to tedious opening and closing of multi-turn needle valves for routine applications. Flow meters and appurtenances must sometimes be installed in turret outlets.*

**F. Compressed Gas Turrets:** Turrets shall be ¼-turn ball type, designed for the specific gas service, except where the use of needle style valves are requested by the program or where necessary to accommodate special gas applications (e.g., oxidizers, high value gases). Where needle valves are requested, valves which open fully with the minimum number of turns are desirable unless precise regulation must be provided at the turret.

**G. Clean for O<sub>2</sub> Service:** Turrets shall be specified of appropriate cleanliness grade for the application. With the exception of fuel gas and vacuum, the turret should typically be factory cleaned to standards for oxygen service.

**H. Turret Use Restriction:** Turrets with serrated tips shall not be used for connection of laboratory equipment, dispense of veterinary medical gas, or for any permanent connection. Turrets, regardless of connection type shall not be used to dispense oxygen, surgical vacuum, or anesthetic scavenging vacuum.

**I. Final Connections to Piping Systems:** Final connections to turrets shall be made with a threaded, brazed, or double-ferrule-type connection applied in accordance with the approved connection type for the type of utility. Compressions joints are not acceptable.

## 8.2.22 Downdraft/Backdraft/Necropsy/Tables, Dissection/Grossing Stations, and Equipment Served from Lab Water

The A/E shall coordinate the specifications of equipment and installation to comply as follows:

1. Faucet and water supply arrangements shall ensure that an ASSE 1001 atmospheric vacuum breaker is provided on the discharge side of any valves, with the critical level of the backflow preventer permanently fixed at least 152 mm (6 in.) above the highest elevation of any flood rim or the highest elevation a hose outlet may be used (whichever is higher).
2. Where the faucet or other water dispense provisions do not meet the above requirement, or where a valve or actuator is located downstream of the device or the backflow preventer would otherwise be susceptible to continuous pressure, an ASSE 1056 spill-resistant pressure vacuum breaker shall be provided on the individual water supply(s) to the equipment. Water supplies are roughed in high with the device critical level at least 152 mm (6 in.) above the flood rim or the highest elevation a hose may be used (whichever is higher), and routed through an exposed ASSE 1056 spill resistant pressure vacuum breaker, and then down with supply stops to connect to the equipment.

3. No water supply to the unit, whether to a faucet, a table rinse feature, or other function shall be provided without provision of point of use backflow protection provided in accordance with the ASSE or FCCHR listing of the backflow prevention device and as described above. If the unit arrangement could in anyway induce back pressure (such as if the unit includes a pump), an ASSE 1013 device is required along with drainage to serve the device. The faucet shall have not less than wrist-blade or extended single-lever handle actuation. The spout shall be goose-neck or high-rise type, spilling not less than 125 mm (5 in.) above the fixture flood level rim with a non-splash laminar flow outlet.
4. Drainage closures for necropsy tables shall be lever operated.
5. Provision of piped drainage versus carboy will be determined on a per-project basis in accordance with risk assessment and consultation with the DOHS. Disposer use is not typically permitted. Waste and tissue shall be properly handled and disposed in accordance with the NIH and BMBL requirements. In some cases, the use of a 3-way valve arrangement may be required.

## 8.2.23 Hose Stations

**A. Application:** Hose stations for ARFs shall be of a suitable industrial grade and shall be securely anchored to structure.

**B. Type:** The use of exposed-type units (not in cabinet-recessed type) shall be provided for ABSL areas. The valve body shall stand off from the wall with an appropriate bracket and piping mounted with appropriate sanitary stand-off pipe straps with all penetrations properly sealed. Mounting must be sufficient so that hose may be hung without impeding drainage of floor water.

*Rationale: Recessed units do not allow for effective sealing and can allow for moisture and pest/vermin. Provision of tightly sealed boxes with rigid sealed penetrations is not cost-effective.*

## 8.2.24 Lab Equipment Water/Waste Outlet Box

### A. Provision, Location, and General Requirements:

An in-wall recessed outlet box to serve utilities such as indirect waste drain, water or other utilities, may be provided if located in the same room as the equipment, provided the outlet box is not concealed or within casework.

1. The box shall be 316 stainless steel, open in front, with a polished finished wall flange and a 50 mm (2 in.) diameter waste outlet centered within the box with an adapter for connection to lab waste. The waste connection shall open to the bottom of the box, which shall include an integral recessed water-tight, seamless sump section to preclude splashing or leakage.
2. The indirect waste connection shall be 20 to 25 mm (0.75 to 1 in.) diameter 304 or 316 stainless steel tube with an NPT-threaded connection projecting from the top of the box to receive the indirect waste line from the fixture or equipment served. The box shall be fabricated with an integral stainless steel tube that enters from the top of the box and is centered over the drain opening, with a termination approximately 50 mm (2 in.) above the top of the waste opening to maintain a visible air gap. The drain tube shall be of rigid construction and guided, anchored, or sealed integral with the box so as not to be displaced.
3. The box shall include a means for rigid anchorage to structure that does not penetrate visible exposed surfaces and shall be sealed at the penetration behind the flange.
4. **Trap Primer:** Where serving undercounter labware washers or other fixtures that may not see routine use, the waste outlet box or tailpiece of the standpipe from the box (on the inlet of the trap seal) shall be fitted to receive a trap primer line and provided with an automatic electric trap seal primer.
5. **Water Supply Connections:** Where appropriate, water supply connections may be integrated with the box and shall include appropriate isolation valves and connector lines, which may



extend out from the front of the box to the equipment served.

***Rationale:** Wall outlet boxes provide a suitable, sanitary indirect waste connection method for fixtures and equipment without concealing the indirect waste receptor (which is unacceptable) or requiring floor drains/floor sinks in labs (which should be avoided).*

## 8.2.25 Fixture Trim Requirements

**A. Fixture Stops:** Fixture stops serving lavatories, sinks, and similar fixtures shall incorporate threaded inlets. The use of compression fittings is undesirable; however, a single compression connection at the downstream side of an angle-type fixture stop may be provided, except for foot- or knee-pedal-operated valves. Fixture stops shall be of the heavy-duty commercial-grade type and shall be the loose key type in public areas.

***Rationale:** Threaded commercial-grade stops are durable and replaceable without need to open walls or significantly disrupt water services. Compression joints are subject to blow-out and flooding; consequently, their use should be minimized to lowest-risk applications. Flared outlets, ground joints, threaded-NPT connections, and double-ferrule (Swagelok) may be utilized for final connections.*

**B. Materials:** Traps, drains, and tail pieces for general domestic sinks and lavatories connected to the sanitary drain system shall be 17 gauge cast brass. Sink strainers and drains for domestic fixtures connected to the sanitary system shall be stainless steel or chrome-plated cast brass. Drains and traps for systems connected to lab waste shall be corrosion resistant type and in accordance with requirements of this section. Bottle traps are not acceptable. P-trap configurations are required.

***Rationale:** Light-gauge and inferior materials (typically for residential applications) generally do not maintain sufficient durability or service life.*

**C. Piping and Appurtenance Support and Anchorage:** Piping to plumbing fixtures and their associated components shall be supported and anchored to the structure.

**D. Utility Coordination with Service Points:** Exposed offsets of trap arms, extensions, excessive tailpiece, or supply length from rough-in shall be avoided by proper rough-in location.

**E. Independent Isolation:** Independent water isolation valves or supply stops shall be provided for each fixture or equipment item.

**F. Check Stops and Mixing Valves:** Thermostatic-mixing valves with check stops shall be provided for fixtures and equipment requiring precisely controlled-temperature water supplies. Check stops or check valves are required in all applications employing normally open thermostatic control or mixing valves.

***Rationale:** Water-system temperature is subject to fluctuation. Appropriate thermostatic protection provides for precise temperature control. Check stops are provided anytime hot and cold water lines are directly interconnected in a normally open (direct flow path) to preclude cross flow and facilitate maintenance. Fixtures that are not normally open to direct cross flow (such as faucets, including mop sinks) are not required to be furnished with check stops.*

**G. Transformer Quantity:** Where electronic sensor faucets or sensor flushometers are utilized, a single transformer shall not serve more than one room. Independent transformers are required for fixtures located outside of restrooms.

***Rationale:** Transformers serving multiple rooms can result in excessive disruption and loss of fixture use in the event of malfunction. The use of common transformers serving a single public toilet room or group of fixtures in the same location is acceptable. Fixtures outside of restrooms (such as in labs or critical hand wash areas) should not be susceptible to total or simultaneous failure.*

**H. Final Drain Connections:** Drain and trap connections exposed or within casework for laboratory sinks, fume hoods, and similar equipment shall be mechanical



joint type from the fixture drain to the trap outlet or within the trap seal using corrosion-resistant materials to match the lab-waste piping system. Type 316 stainless steel may be used for drains and tailpieces except where routinely exposed to chlorides. Drains and traps for floor drains, floor sinks, and fixed equipment other than sinks, in general shall be of materials and joint methods approved in the *DRM* for the waste pipe system serving the item.

*Rationale: Mechanical joint connections are desirable for readily accessible traps below casework serving such fixtures to permit removal of traps for maintenance. Stainless steel drains and components provide general-corrosion resistance.*

**I. Corrosion-Resistance:** Stainless steel type 316 sinks shall have stainless steel 316 drains and shall be fitted with corrosion-resistant removable traps of material to match the lab waste system.

**J. Lab/ARF Area Sink Drain Type:** The preferred drain type is a conventional intercepting strainer/drain cross bar or a flat strainer style drain. Where water retention capability is desired by the program or recommended by the A/E, the preferred approach is through use of a matching removable overflow standpipe fitting into a drain that is equipped with cross-bars, with the standpipe trimmed at least 25 mm (1 in.) below the sink flood-level rim such that the sink may be filled with automatic overflow protection and the “stopper pipe” may be removed without immersing hands. For cage wash and similar scullery-style sink applications, the use of stainless steel automatic drains (e.g., drains with a lever or twist waste) or provision of full-port valved discharge on the drain tailpiece shall be provided.

**K. Utilities Coordination/Casework/Sealing:** The A/E shall adequately direct or detail fixture rough-in locations or installation methods such that water-control valves are fully accessible and properly coordinated with casework openings to provide a neat, finished, and usable function, with capability for sealing in accordance with the requirements of the program area. Utility installations shall maintain integrity of casework, shall not compromise pest control or other sealing requirements, or present sharp edges or unfinished surfaces. The A/E shall coordinate utility requirements with casework specifications.

*Rationale: This provision is intended to ensure coordination and accessibility of fixtures with equipment and casework and to avoid damage to casework shell. Sealing and pest control issues can be especially problematic in ABSL spaces where installations are not properly coordinated.*

**L. Prohibited Drain Materials:** Brass, copper, steel, and cast iron drains and traps shall not be permitted for fixtures or drains receiving discharge from high purity water outlets, lab equipment, blood analyzers, or aggressive discharges.

*Rationale: Such discharges can result in premature corrosion of common piping materials.*

**M. Downstream Connections:** All connections downstream of the laboratory fixture trap shall be as specified for laboratory waste systems.

## 8.2.26 Floor Drain and Floor Sinks: General Requirements

The term “drain” as used for purposes of this subsection is generic, and unless stated otherwise applies to a floor drain, floor sink, trench drain, or similar component.

**A. Floor Drain Locations:** Floor drains are required where water may likely accumulate and create a hazard, and also where intensive wet cleaning and water spray operations are required, including but not limited to the following areas:

1. Kitchen areas, including serving lines
2. Mechanical equipment rooms
3. Toilet rooms with two or more flushometer operated fixtures or water closets
4. Shower or tub room including just outside of showers
5. Service corridors subject to washdown, wet materials, or heavy traffic from exterior, such as loading dock areas and major ARF corridors

6. Non-human primate (NHP) and large animal areas
7. Cage wash areas

**B. Placement:** Avoid locating floor drains in areas of wheeled traffic, travel paths of forklifts or heavy equipment, or other areas which may damage the drain. Drain installation shall not upset proper load-bearing of floor mounted equipment, impose a tripping condition, or upset materials handling loads.

**C. Sediment Buckets and Grate Load Rating:** Non-flushing-type floor drains shall include self-draining sediment buckets wherever drains may be subject to introduction of excessive solids or debris. Floor drain grates and drain tops shall be sized and traffic rated for the application, with grates that are fixed or set so as not to displace or deform with anticipated traffic, including consideration of heavy rolling equipment and tripping hazard. In applications where sediment bucket placement is critical, the use of drain designs that preclude grate replacement without sediment buckets properly installed should be considered.

**D. Drain Specification, Mounting, and Size:** The entire drain shall be corrosion resistant, smooth, and installed to be contiguous with the floor to prevent tripping. Drain bodies shall be self-draining and appropriately rounded and free of sharp corners and fouling spaces. Floor drains shall have minimum 75 mm (3 in.) diameter outlets, except that drains in cage wash areas, loading docks, kitchens, and any exterior drain shall have not less than 100 mm (4 in.) outlets. Drain sizes, sumps, sediment buckets or domes strainers, and tops shall be of sufficient size and configuration to receive the peak discharge load without overflow or splashing. The use of large body floor sinks, large sump floor drains, and similar arrangements shall be provided where receiving piped wastes. Top grates and sediment buckets shall be removable for cleaning. Elevations of influent lines shall be coordinated to maintain an air gap where required (e.g., drains from potable, purified, animal drinking water, ARF, and sterile or sanitary equipment). Grate types shall be appropriate to the area where the drain/receptor is located. Appropriate part-grate designs shall be provided to receive indirect waste, however, part-grate arrangements shall not be used in service aisles or where such may pose a trip or fall hazard.

***Rationale:** Drains must not allow ponding of water or fouling spaces. Drain outlet sizes are to ensure capability for handling solids and sediment while maintaining adequate flow rates to minimize risk of flooding, and to facilitate ready use of common maintenance equipment for effectively clearing drain branches and mains.*

**E. Drain Connections:** Connections to the drainage system shall be by means of hubless, caulked, flanged, threaded, or fused connections only. The use of compression gasket/quick-set joint drain outlets is unacceptable. Drains subject to potential high temperature waste shall have connection types as specified in [Section 8.4 Drainage Systems](#).

***Rationale:** Significant leakage issues in various types of compression gasket joint drains and also in waste lines receiving high temperature waste can occur over extended periods.*

**F. Mounting Height:** Floor sinks and floor drains shall not protrude above the finished floor or be placed at any high spot. The drain top/grate shall be flush with the surrounding finished floor or not more than 3 mm (0.125 in.) below, with the finished floor in the adjacent area sloped or dished toward the drain wherever possible.

**G. Slope of Floor Coordination with Floor Drains:** Floor slope shall be determined by the A/E. Where floor drains are added to existing non-sloped floors in wet areas, slope should be provided at least to a 450–600 mm (18–24 in.) surrounding area unless otherwise determined inappropriate or unnecessary by NIH.

**H. Water Containment/Diking/Berms/Trench Drains:** The A/E shall identify and provide water containment as required (i.e., storage tanks and other stored water sources) that may overwhelm drains and cause damage in the event of failure. Where water containment is required within a space and diking is not possible, the use of suitable trench drains at the appropriate perimeter location may be provided for applications where water is sufficiently clean to not impose sanitation/pest control issues.

### 8.2.26.1 Floor Drain and Floor Sink Materials of Construction

**A. Corrosion Resistance:** All floor drains, floor sinks, and trench drains connected to lab waste system or in cage wash, ARF areas, kitchens, and other areas where sanitation or corrosion resistance is required shall be constructed of at least 14 G Type 316 stainless steel. Where substantial use of chlorides is anticipated, the use of high-alloy stainless materials and stainless alternatives shall be evaluated and provided with sufficiently durable corrosion-resistant traffic-bearing grates. Within cage wash areas, subject to suitable load-bearing, the use of fiberglass grates for trench drains may be accepted.

*Rationale: Type 316 stainless steel, if provided with appropriate surface finish provides effective general corrosion resistance to routine cleaning chemicals and disinfectants. Reinforced fiberglass grates can provide light weight, durable and broad corrosion resistance (including chlorides) and traffic load capability.*

**B. Drainage Pits and Troughs:** Drainage pits (recessed pits with a floor drain inside, with the top of the pit covered by a grate) and similar large sump drain arrangements, trench drains, and troughs may be utilized in cage wash areas, mechanical rooms, and similar spaces. The pit shall be accessible, located within the room where the area drainage originates, fitted with a suitable corrosion resistant, cleanable and removable grate of sufficient load rating for traffic loads, and the interior of the pit shall be of impervious, sanitary, and readily cleanable construction (such as stainless steel or epoxy coated monolithic poured concrete with radiused corners). All hardware shall be sufficiently corrosion resistant, and the pit shall be designed to avoid concealed ledges or fouling areas. The bottom of the pit shall have a slope of at least 2% to a visible and fully accessible drain which is located in the same room as the pit cover and origin of the liquid waste. Pit depth's deeper than 300 mm (12 in.) shall require justification and approval. The floor drain within the pit shall be adequately sized to limit water buildup within the pit and consequent drain surges. Pits should be limited to the minimum size required and in no case should a single drain within a pit serve more than approximately 14–19 m<sup>2</sup> (150–200 ft<sup>2</sup>) of floor area. The entire pit, trough, or trench

(including undersides) shall be fully finished, with no seams or concealed fouling spaces, and shall be one-piece/welded and smooth. The use of gaskets or caulking is unacceptable.

*Rationale: Drainage pits are sometimes desired to receive some surge flow or to provide broad drainage area for items such as wet cage racks. The limitation on depth is due to cleanability, drain maintenance, and avoiding excessive surge loads on drainage systems.*

**C. Anchorage Provisions, Leak Protection, and Required Installation Coordination:** Floor drains, floor sinks, trough, and trench drains shall include integral anchor flanges, which shall be cast into the concrete pour. In any case where the A/E permits a drain opening or trench opening to be boxed out (rather than poured simultaneously), such conditions shall be appropriately doweled to the existing concrete and approved by the A/E to address integrity issues, leakage, and loads.

*Rationale: Anchor flanges are required to maintain drain rigidity in concrete and minimize potential for leakage. Boxed out areas around drains do not maintain strength at the penetration and can be subject to displacement and leakage.*

**D. Material:** Where stainless steel drains/floor sinks are required, the entire drain body and grate shall be stainless.

**E. Mechanical Areas/Unfinished Spaces:** Floor drains and floor sinks in mechanical areas and unfinished spaces that are connected to the sanitary waste system may be cast or ductile iron, stainless steel, or acid-resistant enamel-coated iron.

**F. Drains in Contact with Soil:** Where stainless steel is used in direct bury applications (such as the lowest floor) type 316 or better shall be provided wherever stainless steel is utilized.

**G. Safing Membrane/Waterproofing:** Floor drains, floor sinks, trough, and trench drains and penetrations through wet areas above grade shall be protected with a locally applied water safing membrane and clamping collar, except where floors are protected with a complete

safing membrane or alternate approved waterproofing system. Drains with weep holes shall receive water from the safing membrane. Such drains being installed in existing construction shall be adequately detailed to ensure an installation that will maintain the required load rating and remain water-tight without leakage eventually permeating around the drain body, sawcut area, or area of hole coring. Safing membranes are also required for the entire floor where potential wet areas are located above ARF or other sensitive space. For existing construction, the use of round body drains with multiple hole cored sizes (i.e., a large hole part way through the slab with the drain body flange supported on part of the remaining the reinforced concrete) or similar arrangement along with embedment in polymer-reinforced cement and water safing, or other approved method detailed by the A/E is required. Liquid membranes shall be provided with proper mesh reinforcement.

*Rationale: Safing membranes (solid or liquid-applied type) protect the penetration from being a source of leakage from one floor level to the areabelow. Examples of areas where such penetrations should be provided with safing include cage wash rooms, aquatics areas, and areas where water-hose-down washing or significant wet components are located. Drains installed in existing concrete slabs are often a source of leakage and displacement due to improper or inadequate detailing.*

**H. Drainage Piping Connections, Drains Serving High Temperature Equipment:** The connection of drainage piping to floor sinks and similar receptors shall consider the differential thermal movements between the drain body and the connected piping. Appropriate drain connection arrangements shall be provided for cage washer, sterilizer, and similar drains, which may spill waste at potentially high temperatures even where a blend valve spills to the receiving fixture. Joints that are less sensitive to thermal conditions, such as flanged, threaded, and caulked joints configurations typically perform better than conventional hubless and molded-rubber joints and should be used for applications serving cage washers, sterilizers, and similar applications. Special high temperature mechanical couplings with FPM/FKM gaskets may also be used. Refer to [Section 8.4 Drainage Systems](#).

### 8.2.26.2 Floor Drains in Laboratories: Additional Requirements

**A. Restricted Lab Locations:** Floor drains shall not be located inside laboratories; however, this does not preclude use of indirect waste receptors such as corrosion-resistant funnel drains and floor sinks at utility areas required for discharge from equipment or where otherwise approved by the DOHS. Floor sinks and floor drains shall not protrude above the finished floor.

*Rationale: Provision of floor drains in laboratories may result in inappropriate disposal of materials and chemicals or biologicals that must be otherwise handled by a spill-response protocol. There is also the potential for sewer gas infiltration through dry trap seals.*

### 8.2.26.3 Floor Drains in Animal Research Facilities, Additional Requirements

**A. Small Animal Facilities:** Drains shall be provided in small animal (rodent) facilities only with approval/request of the program administrators, and such drains shall be sealable (gas-tight) and provided with automatic electric trap seal primers.

*Rationale: Rodent-holding rooms are typically wet mopped and vacuumed. Where rooms may be designed for multispecies flexibility or the program use group requests drains, they can be provided if compliant with the DRM and approved.*

**B. Exemption to Trap Seal Primers:** Drains that are of the automatic flushing, jetted, or automatic rinse type are not required to be fitted with trap seal primers. All other floor drains and similar fixtures in the ARF shall include DRM approved trap seal primers.

*Rationale: Sewer gas (and in particular ammonia odors) within ARF areas can be concentrated and in some cases may be disruptive to research and animals.*

**C. Drain Type, Grate Design/Strainer Elements:** The grate design and strainer elements shall provide adequate protection from entrance of large objects without



requiring excessive maintenance to clean drain bodies or cause frequent blockages. Grates shall have sufficient size openings to prevent blockage for the application, non-tilt, and removable for maintenance.

**D. Non-jetted Floor Drains:** Non-jetted floor drains shall have a minimum 200 mm (8 in.) diameter top and a minimum 100 mm (4 in.) diameter outlet. In some applications, larger outlets are required as addressed herein and in [Section 8.4 Drainage Systems](#).

***Rationale:** Adequately sized drains discharge waste water from flushing and washing activities (including those that may have a high solids content) and permit ready cleaning and insertion of drain cleaning tools.*

**E. Load Rating and Anchorage:** Drain grates serving floor drains/flushing drains in an ARF shall not displace under routine pedestrian or cage rack traffic, and shall be adequate for anticipated traffic loading. Tops/grates of drains and cleanouts shall be of sufficient traffic rating and arrangement to preclude dishing, displacement, or breakage.

**F. Sealable/Cleanable/Gas-Tight:** With the exception of jetted/flushing type drains, floor drain tops shall be sealable, smooth, and readily cleanable. Covers for drains that are normally sealed shall be of the fastened, gas-tight, gasketed type, and shall maintain sanitation and cleanability.

***Rationale:** The capability to seal drains gas-tight in a readily cleanable manner is desirable where drains may not be used for extended periods so as to minimize potential harborage of insects and prevent sewer gas leakage. Large animal jetted drains and in-floor water closets do not typically require sealing capability and are not routinely available with solid tops. The sealing of a flushing drain would create a closed connection condition between the water and plumbing system, which would be in violation of plumbing code.*

**G. Drain Bodies:** Drain bodies shall be readily cleanable, free of concealed fouling spaces, sharp corners, flat stagnant areas, and of sanitary design and construction. In general, the use of funnel shape and round sump drains is preferred.

***Rationale:** Drains must minimize the opportunity for insect infestation, maintain sanitation, and facilitate ready cleaning and maintenance.*

**H. Drains Receiving Solids:** Where solids may enter drains (such as at prewash areas), drains shall incorporate a jetted trap similar to floor drains for large animal spaces, with a manual flushometer or manually activated water valve (located in non-concealed area with vacuum breaker) located in the proximity of the prewash or descaling area, but should not interfere with the placement of carts and racks. Jetted drains are not required where solids will be minimal; however, where large amounts of solids are present, the use of a sediment bucket or strainer grate is not a substitute for jetted traps.

***Rationale:** Areas where cages/racks may be washed of solid matter may require jetted operation to flush drains adequately and minimize stoppages. Sediment buckets should not be relied upon to retain solids where excessive solids are expected. The use of sediment buckets or screen plates are ideal where certain wastes must be excluded (such as enrichment toys).*

**I. Corrosion Resistant Material:** Floor drains, troughs, and grates shall be selected to be resistant to corrosion from chemical cleaners and disinfectants utilized in the facility and to concentrated waste products (such as urine from animal holding rooms). Type 316L stainless is the baseline material for drain bodies in many animal holding rooms, and acid resistant enameled cast iron may be utilized for large animal areas where compatible with cleaning chemicals and care is exercised to protect the enameling.

**J. Necropsy and High Sanitation Requirement Spaces:** Floor drains (where provided) in necropsy, similar spaces, or other spaces requiring frequent cleaning shall be not less than type 316 stainless steel.

**K. Trough Drains:** Trough drains shall be constructed of monolithic concrete with appropriate chemically resistant high-performance epoxy or similar coatings contiguous with the floor and finished in a smooth manner so as to minimize dirt adhesion. Stainless steel shall be corrosion-resistant. Where chlorides or other chemicals will be used in concentrations corrosive to type 316L stainless, alternative approved chip and corrosion resistant, sanitary materials are required.

**L. Construction and Slope ARF Trench/Trough Drains:** Trench and trough drains in ARFs shall provide a continuous slope of at least 2%, and shall be of monolithic construction with corrosion resistant coatings or utilize approved corrosion resistant materials with appropriate seamless, heat-fusion-type joints; and the interface with the surrounding floor shall be provided in a smooth, leak tight manner that can withstand repeated high temperature, pressurized hose washing and effects of thermal movement.

***Rationale:** Floor drains and trough/trench drains can be subject to failure if not selected of appropriate materials for adequate corrosion resistance or if adequate care during fabrication, handling and construction do not occur, especially at coating interfaces and joints. Custom troughs designed of suitable materials are available from a number of manufacturers but must be reviewed to ensure long-term durability, resistance to corrosion, breakage, stress cracking, and leakage. Special care is necessary in the selection of plastic due to the permanence of the installation and significant consequences of a failure.*

**M. Trench/Trough Drain Grates:** Trench/trough drain grates shall be of appropriate traffic-rated plastic construction where possible. Grates are not typically acceptable or desirable for troughs at perimeters of large animal holding rooms, and shall not be used where troughs will carry any animal waste or other excessive solid loads, or where large animals are present in open-caging. A recessed ledge may be considered to receive a future grating or cover and shall be provided where required by the program; however, the arrangement shall facilitate a gas-tight seal and must be carefully reviewed for potential pest control, sharps, and sanitation issues. Trough placement shall be coordinated with racks.

***Rationale:** The use of sufficiently durable plastic grates (typically fiberglass) provides lightweight grates that are easy for personnel to maneuver for maintenance and cleaning, and reduce the potential for damage to surrounding wall and floor coatings and finishes during repeated removal, replacement, and routine handling.*

**N. Same Room Service:** Troughs and trench drains shall not extend to/communicate from one room into another. Drains shall start and discharge within the same room served.

#### 8.2.26.4 Floor Drains, Trench Drains, and Troughs in Large Animal Spaces

Drains in large animal spaces (NHPs, kennels, etc.) shall conform to the following additional requirements:

**A. Trough Slope and Rinse Nozzles:** Troughs shall be provided with a minimum of 2% slope and an end wash nozzle or rinse pipe. Troughs/trenches shall be located such that the overflow point is flush with the finished floor. Sufficient flow, slope, trough design, and nozzle quantity to carry wastes shall be provided. Multiple nozzles may be used where required; however, designs shall achieve effective solids handling without wasting water, overflow, or splashing.

**B. Trough Corners:** Trough corners shall have a smooth, rounded radius of at least 20 mm (0.75 in.), shall be seamless, and incorporate approved water and chemically resistant coatings.

**C. Trough Rinse:** Trough rinse shall be provided for troughs in large animal holding rooms and may be activated by a ball valve within the holding room or as selected by the user group. A single valve should preferably control all troughs in a room. The A/E shall provide a manually adjustable balancing valve (preferably concealed) to facilitate adjustment of flow and control of splashing to individual troughs or nozzles. The end of each trough nozzle shall be pointed downward in the direction of flow toward the trough, to sweep wastes. Discharge of the lowest point of the nozzle shall be fixed so as to be at least 40 mm (1.5 in.) above the flood-level rim of the trough (so as to maintain the required air gap). Trough rinse fittings should be stainless steel and shall be arranged to permit replacement. Trough rinses and hose stations shall not substitute for each other where either is required.

**D. Trough Rinse Minimum Flow:** The minimum flow discharged to the end of the trough shall be sufficient to ensure at least a 0.61 m/s (2 ft/s) velocity in the trough (preferably higher) and to sufficiently wet the trough interior without flooding. The A/E shall calculate the required trough rinse volume based on trough shape and dimension (as open channel flow).



**E. Troughs' Discharge:** Troughs shall discharge into the tailpiece served by a jetted drain trap or into an in-floor flushing fixture with integral jetted trap in accordance with this section.

**F. Open Troughs:** It is generally preferred that troughs remain open and do not have any grating or covers. Trough placement, wall protection placement (wall guards), and rack selection shall be coordinated so as to avoid the need for covers, with troughs placed outside of traffic areas. The provision of grating or covers within animal holding rooms requires justification and NIH approval.

**G. Drains/Troughs for Flexibility:** Where drains/troughs are provided only for flexibility, the drain body shall be capable of being sealed gas-tight and the use of an automatic electric trap seal trap seal primer shall be evaluated.

***Rationale:** These provisions facilitate transport of solids, cleanability, and durability for troughs in ARFs and maintain sanitation and adequate drainage. Trough covers create concealed, unwashed, difficult to clean areas, and often leak. Hardware attaching grates can be problematic. Where drain troughs are provided for future use, it is typically better to seal the drain or leave drains open with automatic electric trap seal primers than to introduce the issues associated with covers.*

**H. Trough Discharge:** Troughs shall discharge to an approved drain arrangement with a minimum 200 mm (8 in.) diameter top, which includes a jetted trap.

**I. Drain Type:** Drains shall be the fully flushing type, including a rim wash of the interior drain body. Where flushing troughs are provided which will adequately rinse the drain interior, only the trap must be jetted and it is acceptable that the rim wash may be omitted. Drains with rim-wash arrangements are typically recommended in all applications to ensure thorough cleaning of the drain body interior. Drain interiors must be round or funnel shaped and with no horizontal flat surfaces to allow solids accumulation.

## J. Jetted Drain Trap Arrangements:

1. Jetted drain traps with a minimum 200 mm (8 in.) diameter top shall be provided and shall include stainless steel tubular bar grate and a flushing rim feature and a minimum ball pass of approximately 70 mm (2-3/4 in.). Drain bodies shall be constructed of acid-resistant enamel-coated cast iron or type 316 stainless steel (unless bleach is routinely utilized), be free of flat horizontal interior surfaces, and shall have a round or funnel shaped interior basin to channel solids to the waste system. In-floor, stainless steel blow-out action water closets (such as available for detoxification cells) may be utilized provided the drain body is of the round or funnel shaped type with no flat bottom ledge, and top shape and size may be modified or extended as required by the manufacturer to integrate with holding room drain troughs. Troughs may require an enlargement to receive the drain body, which shall not be located where it may interfere with rack placement or movement. Traps shall be corrosion resistant.
2. Separate jetted traps may be utilized (instead of manufactured, in-floor water closets or similar drains specifically designed for complete evacuation of solid waste). Where such independent jetted traps are used, the trap configuration, ball pass, radius of the trap pattern, and jet location shall be specifically designed to evacuate the drain and transport solid waste through the downstream piping. A minimum ball pass of approximately 70 mm (2-3/4 in.) should be provided. The trap material shall be corrosion-resistant typically type 316 stainless steel of not less than 1.65 mm (.065) in. wall thickness, or custom fabricated of appropriate alloy or compatible, durable corrosion-resistant plastic such as PVDF equivalent to Schedule 40. The use of trap primer tappings for the water jet connection is not acceptable. Connections to traps shall be designed so as to preclude leakage or eventual failure.

**Rationale:** *Drains in large animal areas must be capable of completely flushing solids from the drain body and through the piping system to maintain sanitary conditions and prevent waste stoppages. Trap configurations are often custom-manufactured and paired with flushing rim drain tops and/or rinsed troughs to serve this function. The sweep pattern and radii of the trap must maintain self-cleaning properties and the blow-out jet must be properly configured to maintain the trap seal and evacuate solids. Blow-out pattern p-traps (as typically available or custom made from stainless steel penal ware and specialty drain manufacturers) may be used for this purpose; however, the connection of a flushing jet through a conventional trap primer tap does not provide for appropriate operation.*

3. The jetted flush actuation shall be activated by automatic means programmed for routine flushing throughout the day and shall also facilitate manual activation by the use group for individual rooms.
  - a. Control of flush volume may be achieved by use of hydraulic flushometers with a pushbutton located in the holding room (or other designated location), and with a programmable timer and solenoid valve or electronic arrangement to actuate the hydraulic flushometers by creating a bypass around the hydraulic button with a normally closed (fail closed) solenoid valve between the hydraulic lines.
  - b. Alternatively, programmable operation through the ARF control system may be provided, so long as a suitable flush button or manual activation means is also provided in each room to permit manual activation by facility staff. The automatic means shall allow for individual programming of drains per room (or per suite where so approved by the use group). Solenoid valves, if used for this purpose must be ported for sufficient flow rate and be of a soft-close (non-water hammer) design.

- c. A vacuum breaker shall be provided for each flush connection (either as a flushometer with vacuum breaker tailpiece or as a dedicated stand-alone vacuum breaker).
- d. Flushometers or valve arrangements and associated piping shall provide a minimum 25 lpf (6.5 gpf) operation, and shall be coupled with 100 mm (4 in.) or larger drainage mains for NHP and kennel areas. Where other automated arrangements are used (such as solenoid valves), ensure an equivalent flow volume at a rate of not less than 95 – 115 lpm (25 – 30 gpm) is provided for each flush connection with a flowing duration of at least 10–15 seconds.

**Rationale:** *Automatic flushing capability is required at regular intervals to prevent odors and maintain sanitary conditions. Manual override is required to facilitate cleaning operations. Drains must be capable of programming to the individual requirements and operational status of each room. The vacuum breaker is required to isolate the direct connection.*

4. Provision of trough rinse arrangements and provision of basket strainer, grates/buckets is not a substitute for jetted traps.

**Rationale:** *Such arrangements do not adequately or consistently clean traps or achieve velocities and pressures to flush lines. Grates, buckets, and strainers are often removed, and result in solid wastes entering drains.*

5. Manufactured blow-out, in-floor water closets and engineered blow-out/jetted traps shall be connected to waste systems with a minimum trap arm diameter of 75 mm (3 in.), and a diameter of 100 mm (4 in.) is recommended.

**Rationale:** *Collector mains for animal holding rooms must be a minimum of 100 mm (4 in.) diameter and at sufficient slope to carry wastes, solids, and peak water inflow rates without*

*stoppage and to permit efficient maintenance. While mains must be adequately sized, oversizing mains can increase potential for stoppages, especially when coupled with inadequate slope and hydraulic load.*

6. Jetted traps may be omitted with justification and approval, provided the trap and drain is at least 150 mm (6 in.) diameter, the drain is flushing type, and a sufficient trough arrangement with adequate flow has been provided to ensure a substantial and routine water flush. Any drainage main that is not served by jetted traps shall be a minimum of 150 mm (6 in.) diameter and shall be provided with adequate flow rate to ensure a 0.61 m/s (2 ft/s) velocity and sufficient hydraulic depth is routinely achieved with a slope of 2–3%. Omission of jetted traps is not recommended, but may be approved under these conditions at the discretion of the NIH.
7. Where large animal species are required as part of the program (larger than NHP type), special design requirements will be required for drains and troughs and will vary with the program and housing/pen configuration, and shall be subject to project-specific predesign meeting and additional project-specific requirements. Drains will generally be required as epoxy-coated concrete flushing troughs with drain and pipe line sizes in no case smaller than 150 mm (6 in.).

## 8.2.27 Roof and Overflow Drains

Refer to Section 8.4 Drainage Systems for further details.

**A. Materials:** Roof and overflow drains shall be constructed of cast iron or ductile iron, and the sump shall be sized with adequate free area for the storm water load. Dome grates shall be of cast iron construction or other, non-plastic material.

**B. Drain Outlet Diameter:** No roof drain or overflow drain may have a drain outlet diameter of less than 75 mm (3 in.).

**C. Drain Selection:** Roof drain and overflow drain selections shall be matched to the specific roof construction. The roof drain design shall preclude buildup of water below the finished roof membrane.

**D. Drain Type:** Siphonic-type roof drains and controlled flow (on-roof water retention) roof drains are not acceptable.

**E. Downspout Receivers:** Provide durable arrangements suitable for the installed location and configure to prevent entry of excessive debris. Arrange to facilitate a means of clean-out for downstream horizontal piping.

*Rationale: These provisions ensure durable drain installations with minimal potential of leakage. Non-plastic dome grates are selected to preclude displacement.*

# Section 8.3

## Water Systems

---

### Contents

- 8.3.0 Introduction
- 8.3.1 General Requirements
- 8.3.2 Water Service
- 8.3.3 Water Storage Tanks
- 8.3.4 Distribution Systems
  - 8.3.4.1 Pressure and Flow
  - 8.3.4.2 Pressure Boosting
- 8.3.5 Building Water System: General Design Criteria
- 8.3.6 Backflow Protection
- 8.3.7 Emergency Fixture Water
- 8.3.8 Hot Water Systems
- 8.3.9 Hot Water Circulation and Temperature Maintenance
- 8.3.10 Hot Water System Temperature Control and Over-Temperature Protection
- 8.3.11 Additional Requirements for Animal Research Facilities
- 8.3.12 Corrosion Protection, Water Treatment, and Control of Scale
- 8.3.13 Available Water Supply/Water Supply Analysis
- 8.3.14 Research Equipment Water
- 8.3.15 Equipment and Material
- 8.3.16 Quality Control, Startup, and Verification

## 8.3.0 Introduction

This section addresses pressurized water systems, including potable and non-potable supplies.

This section is not all-inclusive of *DRM* requirements, and shall be used along with other sections of the *DRM*.

## 8.3.1 General Requirements

**A. Quality/Reliability:** All water systems, including potable, laboratory and non-potable equipment makeup shall be designed and constructed to maintain water quality and provide adequate flow and pressure for proper operation of the installed fixtures and equipment. Potable grade materials shall be used for all systems even if defined as non-potable.

*Rationale: By constructing all systems similar to potable water standards, the potential of inherent system contamination, premature corrosion and risks in the event of misuse are minimized.*

**B. Fire Protection Systems:** Once systems are segregated by backflow preventers for fire protection purposes, they fall under the scope of [Chapter 9: Fire Protection & Suppression](#).

**C. Critical Services:** Potable and laboratory water supplies in labs and animal research facilities (ARFs), including supplies to infrastructure, are critical services and shall be arranged to preclude plausible single point failures resulting in loss of water supply.

**D. Systems Disinfection and Elastomers:** Components and elastomers of potable and lab distribution systems shall be suitable for hot water sanitization at temperatures of up to 80°C (180°F), as well as for chemical sanitization with chlorine (or for entirely stainless steel systems with no copper or brass components, hydrogen peroxide/peracetic acid) solutions. Elastomers shall be of suitable inert materials, and shall not be constructed of natural rubber. Elastomers shall comply with plumbing code and be listed in accordance with NSF-61 or 21 CFR 177.2600 provisions. NSF-61 commercial hot classification is required for components for hot water systems.

*Rationale: Natural rubber is undesirable as an elastomer as it often serves as nutrient to bacteria. Generally, for pressurized lab and potable water systems, ethylene propylene diene monomer (EPDM) of NSF-61 grade is preferred, though many other elastomers may be acceptable.*

**E. Dead-legs:** Piping systems shall be arranged to minimize presence and length of dead-legs. Dead-legs created by any renovation or abandonment of systems shall be removed to active points of mains.

*Rationale: Minimization of dead-legs is desirable for microbial control and to preclude stagnation.*

**F. Dielectric Protection:** Dissimilar metals within the same piping system shall be minimized. Dielectric protection shall be provided between dissimilar metals including between galvanized steel and stainless steel, ductile iron and copper or stainless steel, as well as between copper and stainless steel that is not assuredly maintained in the passive state or where the predominant material (by wetted surface area) is stainless. Dielectric protection may be avoided only in low corrosion risk applications where the wetted surface area of the cathodic material is sufficiently small relative to the anodic material. Dielectric protection shall be as follows:

1. Dielectric unions should be avoided. The use of manufactured dielectric waterways with high temperature polypropylene or PVDF liners is preferred.
2. Dielectric flange kits complete with bolt isolation sleeves shall be provided for flange transitions between dissimilar metals.
3. The use of brass or bronze valves, fittings, or piping shall not serve as approved dielectric protection between dissimilar metals.
4. The dielectric fitting shall be installed directly to the anodic material without any intervening brass fittings between the anodic material and the dielectric isolator.

*Rationale: Dielectric isolation is required to control galvanic corrosion and protect systems*



*from leakage and failure. Dielectric unions often leak or otherwise fail to isolate the electrolyte and provide sufficient protection. Isolation is required for stainless steel transitions in some applications due to the potential for corrosion as a result of open systems and variations associated with grade and passive state.*

## 8.3.2 Water Service

### A. Arrangement and Redundancy of Water Services:

Each lab, animal, and other critical facility (including central plants serving such facilities) shall be provided with two normally operating (online) water services, each sized for total demand. The points of connection of each water service shall be coordinated with the location of site utility isolation valves and arranged to ensure continuous supply to the facility from either direction in the street mains in the event of loss of water from either side (which may occur due to a break in a street or service main or closed valve). The length of buried water service piping within the building shall be minimized to a single fitting consisting of not more than two joints and maximum horizontal of 5 ft.

*Rationale: Even short-term loss of water supplies to facilities can severely impact required environmental conditions serving ARFs, can disrupt critical activities, and could result in release of heavy particulate loads or other contaminants during repressurization.*

Approaches to facility water service shall be as follows:

1. Where two completely separate water services are provided to a building, it is preferred that they be of a combined type with each sized to serve the total domestic water and fire load.
2. Where separate domestic water and fire services must be used (not preferred), the domestic services shall be redundant and the arrangement of fire services shall be in accordance with [Chapter 9: Fire Protection & Suppression](#).

3. All dedicated fire service lines shall be provided with a lockable post indicator valve (PIV). Underground valve box arrangements are not equivalent. Where the branch from the combined service to serve dedicated fire protection occurs above ground, a PIV is not required; however, valving on any portion of the system serving downstream fire protection shall be outside stem and yoke (OS&Y) type and continuously monitored in accordance with the Division of the Fire Marshal (DFM).

*Rationale: The use of redundant combined services provides N + 1 reliability, capacity, and corrosion and freeze protection. Providing two services, but sized and arranged as combined services, ensures an economical approach to accomplish the intent of building water supply system redundancy and increased reliability, with the added benefit of providing redundancy for fire protection and providing continuous monitoring of water supply availability and control of corrosion, sediment, and freezing risks to water supplies.*

**B. Incoming Water Service Sizing:** The incoming water service shall be sized to incorporate the criteria of plumbing demand flow rate at a maximum velocity of 2.4 m/s (8 ft./s), and, in the case of combined water services or underground mains, total plumbing water demand plus fire system water demand at a maximum velocity of 4.9 m/s (16 ft./s). Fire department hose stream and sprinkler demand shall be added as operational simultaneous demands at the point where they occur and plumbing demand calculations shall be appropriately coordinated with the fire protection engineer.

*Rationale: This is to ensure systems are adequately sized so that fire flows are not impacted by ongoing plumbing and equipment water supply demands which may be in operation at the time of a fire.*

**C. Water Service Connection to Campus or Municipal Supply Mains:** Where connections to separate points on the underground water supply grid cannot be made, the water service to each facility shall be double-fed or have two parallel mains from the site utility supply grid.



They shall be located in separate trenches, with site utility isolation valves arranged to ensure continuous supply from either direction of the street mains in the event of loss of water from either side of the serving site water supply system. An emergency water connection as noted within this section shall also be provided.

***Rationale:** The intent is to avoid or minimize, dead-end feeds while providing redundancy. Where a special condition precludes compliance (such as a remote or private water supply), appropriate redundant active accommodations as approved by the Authority having Jurisdiction (AHJ) are required.*

**D. Conformance:** Water services systems shall be subject to inspection by the Office of Research Facilities (ORF) and DFM, which shall include joint restraints and thrust blocks. Water services shall conform to American Water Works Association (AWWA) standards, plumbing code, *DRM*, guidelines of the Ductile Iron Pipe Research Association (DIPRA), requirements of geotechnical reports for excavation including bedding, corrosion protection, and compaction, and where serving fire protection shall also comply with NFPA-24.

**E. Backflow Preventers:** Upon entry into the building, each water service shall be provided with service entrance backflow preventer(s) sized for 100% demand load, (ASSE 1013 type for domestic water, and ASSE 1015/1048 or ASSE 1013/1047 type for fire service as appropriate). Where only a single water service is utilized to supply each system, backflow preventers (BFPs) on the individual service shall be arranged in parallel and sized to provide N + 1 redundancy. Backflow preventers for fire service shall be Underwriters Laboratories listed/Factory Mutual (UL/FM) approved, and without strainers. The acceptable pressure loss and flow criteria shall be specified and verified in submittals and coordinated with the fire sprinkler system designer's hydraulic calculations. All backflow preventers shall be indicated on plumbing system documents, process systems shall not commence until downstream of required backflow preventers. Backflow preventers shall be located at the water service entrance to the building, prior to tappings.

***Rationale:** This is to allow for a continuous water supply and constant system pressurization including routine testing and servicing of backflow preventers.*

**F. Maintenance of Bidirectional Arrangement:** The arrangement of backflow preventers in buildings shall not compromise the bidirectional feed capability of site water mains. In some cases, water mains through building tunnels at the NIH may be classified as part of the campus water-main-supply grid. In such cases, the service-entrance backflow preventers to each individual building shall be provided from a dedicated branch taken off the supply main to preclude disrupting bidirectional flow through the supply grid.

**G. Series Backflow Preventer's Limitation:** Fire service shall split off upstream of domestic water service-entrance backflow preventers such that main fire service backflow preventers are not in series with any other service-entrance backflow prevention devices. This prohibition does not apply to plumbing or laboratory water system backflow preventers not serving fire systems.

***Rationale:** This is to preclude undesirable additional pressure loss. Backflow preventers on lab systems are often in series with the incoming water service backflow preventers (and typically located downstream of the incoming water supply booster pump where required). This approach precludes need for redundant pumping systems and multiple emergency water connections.*

**H. Intertie:** The intertie between the multiple services shall be made at the main booster pump suction or subsystem header, arranged to minimize potential for single point failure or service loss and to maximize benefit of the supply redundancy.

***Rationale:** This is to maximize the benefit of the redundant water service to a point where subsystem branches occur.*

**I. Emergency Water Connection:** An emergency domestic-water connection arranged to receive potable water shall be provided for critical facilities (including

but not limited to major lab buildings, ARFs, aquatics facilities and mechanical areas serving such facilities). The emergency water connection shall be provided with a normally closed and locked shut-off valve and check valve located inside the building, and shall terminate with a capped threaded inlet(s) at an approved location to receive connection from a portable water supply source. The emergency water connection shall connect to the water distribution system on the suction side of booster pumps, downstream of the main building water service entrance backflow preventers. An isolation valve shall be provided immediately at the connection to the system to avoid stagnant dead-legs, as well as a valved and capped flushing connection of at least 40 mm (1.5 in.) diameter to permit flushing of the feed line prior to use. Only a single emergency water connection point should be provided per building, unless otherwise approved.

1. The inlet opening serving as the emergency water-service connection shall be labeled, provided with a threaded cap, and either valved and locked closed or valved and located in a locked access box to preclude tampering.
2. Emergency water connections shall not serve as a substitute for the redundant water service.

**Rationale:** *The emergency water connection is used by a potable water tank truck, fire hydrant, or when a temporary potable water supply is needed to maintain critical operations in the event of significant malfunction, maintenance, or disaster mitigation.*

**J. Joint and Fitting Restraint:** Underground fittings shall be provided with concrete thrust block joint restraint. Restraints for systems subject to bidirectional flow shall be designed to accommodate forces from flow in either direction, regardless of normal use. Joint restraint shall be provided for above ground water services as required to prevent failure.

**K. Incoming Water Filtration System:** Filtration is required for lab, ARF, and clinical facilities only. Downstream of the service-entrance domestic-water system backflow preventers, the domestic supply main shall incorporate a municipal grade/industrial quality, automatic, self-cleaning, incoming water-filtration

system of the self-cleaning screen or self-cleaning cartridge type, designed for use in potable water systems to filter particulates with screens rated at nominal 10–20 microns and performance efficiency of ~90%. Deep-bed filters and activated carbon filters shall not be used for this purpose. A normally closed bypass shall be provided. Filter housings shall be type 316 stainless steel or approved fusion-bonded epoxy-coated ductile iron, NSF-61 compliant. Screens shall be multi-layered stainless steel weave wire or stainless steel sintered mesh as appropriate. Such filters shall maintain continuous filtration and demand flow in the backwash mode, or shall be provided in an N + 1 configuration normally open in parallel. Where a surge tank is used to throttle flushing discharge, a manufactured air gap is required between the filter and the tank.

**Rationale:** *Elevated total suspended solids (TSS) may be present in the form of sediment, silt, rust, sand, and other particulate, etc., from piping, construction activities, hydrant testing, and scale in water mains. Point of entry automatic central filtration of water supply is beneficial to reduce maintenance and service demands of numerous components throughout the distribution system. The use of cartridge filters, though highly effective if properly selected, is not desirable due to the maintenance frequency, potential of accumulated organic matter where not adequately maintained, potential loss of supply under heavy load, and ongoing operational costs.*

**L. Disinfectant Injection/Residual Disinfectant Maintenance and Treatment Devices:** Water distribution systems shall be arranged to maintain the efficacy of residual disinfectants (e.g. chlorine) provided in the municipal feed water supply to the point of use. Supplemental disinfectant injection systems for special needs shall be addressed on a project-specific basis with full water chemistry and analysis to ensure control of disinfectant and byproducts. Where an approved application proposes removal of disinfectant residual or other filtering (e.g., commercial food service beverage dispensing), each such treatment device shall be located only at individual end points of use. Refer to Microbial Control within [Section 8.3.8 Hot Water Systems](#).

### 8.3.3 Water Storage Tanks

**A. Large Storage Tanks:** Large water storage tanks shall be avoided in potable and lab water systems unless such tanks are arranged to ensure maintenance of water quality; including daily turnover and adequate provisions for microbial control, protection from contamination, control of sediment, scale, cleaning, security, and provisions for maintenance. Where tanks are approved, tank materials shall comply with NSF-61 and standards of ANSI/AWWA. An approved means of maintaining and monitoring residual disinfectant levels and consideration of chemical byproducts is required. Tanks shall be arranged with backflow prevention/fill configurations to protect upstream water supplies from flow reversals. Tanks for potable water shall be properly insulated to control heat gain (and to the extent practical should be maintained to not exceed 18.5°C (65°F)). Tanks shall be adequately protected from internal and external corrosion, structural displacement, and shall be ASME code, closed type. A rigorous quality assurance plan is required for linings. Material options shall be presented for review for each application. Use of large tanks (e.g., greater than 1,890 L [500 gallons]) shall be approved on a case-by-case basis. Storage tanks within building water distribution systems are generally unacceptable.

*Rationale: Potable water is required in accordance with plumbing code and the requirements of the Safe Drinking Water Act (SDWA) for general domestic, bathing, and culinary purposes; it must not be subject to chemical or biological contamination.*

**B. Laboratory Water Supply:** A separate and distinct central laboratory/non-potable water subsystem shall be provided and distributed throughout the building, sourced and isolated from the domestic water system with parallel ASSE 1013 backflow preventers, which have been sized and arranged to provide N + 1 redundancy. This system serves general laboratory areas, cage and rack washers, fume hoods, and ARF hose stations. The laboratory system shall not serve any outlets intended for ingestion, bathing, or pharmaceutical, medical/clinical applications (whether for humans or animals). Laboratory systems shall be designed to maintain a clean, reliable water supply free of dangerous and unprotected high hazard cross-connections, using materials and methods generally consistent with potable water systems as commensurate with risk.

*Rationale: The provision of a dedicated laboratory water system precludes the need for numerous high hazard type point of use backflow preventers (and associated drains as would be required in each lab for equipment and ARF operations, as well as their associated trap-priming devices, biosecurity issues, flood risks, and maintenance costs).*

### 8.3.4 Distribution Systems

The use of two segregated distribution systems shall be required for laboratories and ARFs.

**A. Domestic Potable Water Supply:** The first system shall consist of domestic potable hot and cold water distributed to toilet rooms, shower/bathing rooms, food service, emergency fixture water supply makeup, surgical hand wash, animal food prep, surgical instrument prep, animal drinking water system makeup, and similar domestic and culinary functions. Water supplies to all domestic plumbing fixtures shall be potable, and the makeup supplies to laboratory and ARF areas shall originate from the potable supply, separated only by the indicated backflow protection.

**C. Single System Potable-Water Distribution:** Facilities that do not incorporate a predominant lab or ARF function, or off-campus facilities where primary users may be transitory users rather than in-house professional staff, may require single potable-water distribution with point of use backflow preventers in lieu of application of segregated lab and domestic water systems. In such cases, the A/E shall ensure backflow preventers are selected in accordance with code and device listing requirements (e.g., lab faucets would require ASSE 1035 devices, and many other applications will require point of use ASSE 1013 protection). Where such a distribution approach is proposed at the NIH, justification and approval of the ORF is required. Justification and associated prior approval is not required to utilize this

approach for non-lab/non-ARF, such as office buildings. This approach is not approved for high containment. Adequate drainage and access for devices is required to accommodate worst case discharge conditions, and a control process to ensure logging, tracking, maintenance and annual testing of devices is required.

***Rationale:** High containment applications have additional safety and biosecurity concerns, and shall conform to DRM requirements.*

**D. Potable/Non-potable Water Use:** Arrangement of systems to supply potable and lab or non-potable water use shall be determined from [Table 8.3.4](#). Mechanical makeup water and water serving HVAC equipment

shall be from potable water systems with local backflow prevention. Differing types/applications of dedicated non-potable systems shall not be interconnected.

**E. Alternative Water Supplies:** The use of any alternate on-site non-potable water shall require express approval from the ORF and DOHS, and shall not be permitted to serve any ARF, aquatics, laboratory, clinical, hand wash, or potable demand application. The use of alternate on-site non-potable water source shall be accompanied by an analysis of the reliability, fluid quality and environmental or other benefit. Such systems shall require preapproval by ORF on a per-project basis and shall be requested early in the design process.

**Table 8.3.4 Water Distribution**

Domestic Potable Water	Non-potable/Lab Water
Toilet rooms and janitor sinks	User laboratory equipment
Kitchen/pantry/food service/break rooms	Labware washers
Public spaces	Hose stations
Sterilizers, clinical instrument washers (with local BFP), including ARF areas	Laboratory (non-clinical/non-surgical instrument) autoclaves
Shower facilities	Laboratory/process sinks
Eyewash/drench showers (isolated at each floor from building potable water supply by a RPZ backflow preventer before entering a laboratory)	Eyewashes & emergency showers in existing building only where potable water source may not be obtained within or near to boundaries of project, scope is a very minor renovation of a single space, and justification and approval obtained
Water coolers and drinking fountains	Ice machine (laboratory use only)
Medical treatment areas/human clinical spaces and support areas	Fume hoods
Surgical area hand washing and surgical instrument processing (surgical instrument sterilizers), including ARF areas	Necropsy area tables and downdraft/grossing sinks
Laundry and dishwash equipment	Cage/rack/tunnel washer
Animal food prep	Animal research facility holding rooms (washing)
Animal drinking water system makeup (w/ BFP)	General lab/ARF hand sinks (except surgical prep)
Central high purity water system makeup	General ARF animal holding room applications
Barrier facility bottle washer/sterilizers (w/ BFP)	Animal room trough flush and jetted traps
Cleanrooms and pharmaceutical spaces	In-lab water treatment (except USP/pharmaceutical)
Aquatics system makeup, aquatics area wash equipment	Trap primers
Trap primers	

**Abbreviations:** BFP = backflow prevention;  
RPZ = reduced pressure zone



**F. Isolated Potable Water Supply:** Local isolated potable water supply systems may be applied for limited, special applications as justified by unique project requirements. Such systems shall be supplied directly from potable water, protected with an ASSE 1013 backflow protection arrangement, and appropriately identified as an “Isolated Potable Water Supply” with the specific function clearly indicated. Provision of isolated water does not waive requirements for application of point of use backflow protection as defined in the code.

*Rationale: Potable water with special treatment may be required for unique conditions requiring a distinct, isolated, yet still potable system (e.g., aquatics, cleanrooms or other restricted spaces).*

**G. Booster Pump System and Commence of Lab Water System:** In most cases, a booster pump system will be required to meet water pressure requirements. In such cases, the lab water system shall begin with backflow preventers installed as a subsystem on the downstream side of the booster pumps.

In cases where water pressure requirements to the most remote outlet may be met without a booster pump, the A/E should review the potential of arranging the lab water backflow preventers in parallel with the domestic water service backflow preventers. The A/E must also consider the affect such arrangement will have on emergency water connections (which are required to be connected to systems downstream of the service backflow preventer), and would therefore result in requirements for multiple connections and associated protocols.

### 8.3.4.1 Pressure and Flow

**A. Analysis:** Water supplies shall be carefully analyzed and systems shall be zoned to ensure required pressures will be available throughout the design life of the facility. Refer to [Section 8.3.13 Available Water Supply/Water Supply Analysis](#).

**B. Flow and Pressure Requirements:** The water distribution system shall be designed to provide the required flow and pressure for the most hydraulically demanding fixture/equipment. Systems shall be designed to provide at least 280 kPa (40 psi) residual (flowing) pressure at the most hydraulically remote outlet on the lab water system and at least 240 kPa (35 psi) residual pressure for

the hydraulically remote fixture on the domestic plumbing system. Water pressure to non-occupied mechanical equipment floors shall be at least 170 kPa (25 psi) on the downstream side of isolating backflow preventers, and may be boosted locally, provided supply arrangements are adequate for the pump suction.

*Rationale: Adequate pressure and flow is required for the proper operation of equipment and plumbing fixtures, and to ensure programmatic flexibility. Pump suctions shall not induce backflow on other portions of the system. Code minimums are not adequate.*

**C. Excess Pressure Control:** Systems shall be designed to ensure pressures (including static and surge pressures) are controlled and within working pressures of system components. A pressure-reducing station shall be provided if required to limit maximum water pressure to 550 kPa (80 psi) at any service outlet. When serving multiple rooms or program areas a minimum of two pressure-reducing valves shall be provided in parallel, and may be of segmented load (e.g., 1/3–2/3) as appropriate for effective control. A normally closed bypass or sufficient redundancy arrangement should be considered for central stations serving significant areas of a facility. Major pressure-reducing station valves shall be of the hydraulically-operated pilot-type automatic-control valve, municipal grade with stainless steel trim. Where justified by application and approved by the ORF, pressures may exceed these limits. Ductile iron with epoxy, lead-free bronze, or 316 stainless steel shall be used for cold water; lead-free bronze or 316 stainless and with high temperature elastomer for hot water.

**D. Application of PRV's, Zoning, and Circulation Systems:** Pressure-reducing valve use shall be limited to point of use equipment applications, except that where general pressure-reduction is required, it shall be arranged by pressure zones to eliminate excessive maintenance associated with numerous local devices. The pressure distribution concept (upfeed/downfeed) arrangement shall be similar between hot and cold water systems. Forced circulation through pressure-reducing valves in a closed loop is not permitted.

**E. Pressure Balance:** Hot and cold water distribution to each area shall be from the same pressure zone,

with systems arranged to provide generally balanced (nominally equal) pressures between hot and cold systems. Where pressure-reducing valves are permitted and applied, the arrangement shall ensure that under all conditions hot and cold systems shall be generally balanced.

***Rationale:** Providing a relative balance of pressure between water supplies minimizes potential of cross flow, scalding, and inadvertent temperature fluctuations.*

### 8.3.4.2 Pressure Boosting

**A. Booster-Pump Systems:** Where building water booster-pump systems are needed, they shall incorporate the following features:

1. Connected to building standby power (for any lab or ARF application)
2. Size and quantity with capacity split for efficient operation under peak demands and minimum design flow
3. N + 1 redundancy of total demand, including simultaneous design load of emergency fixtures (typically an allowance of two to four shower fixtures per building; verify with the DOHS) with all pumps running. Sufficient capacity shall remain for at least one emergency shower plus peak load with any pump out of service.
4. Pumps shall be centrifugal type and all pump systems shall be arranged to ensure control of maximum energy imparted to the distribution system.
5. Lead/lag/automatic alternate with failure logic to maintain operation; alternation to occur at intervals not to exceed 24 hours to avoid stagnation, and minimum run timers.
6. Arranged to permit service of single pump or controller with all remaining pumps in service.
7. A constant pressure bypass (with PRV control) shall be provided to ensure continuous service

with the variable frequency drive (VFD) or control panel out of service. The A/E shall ensure that the arrangement of the constant pressure bypass will not result in an unacceptable overpressure condition. Alternatively, a completely separate automatic, alternating pump system may be provided where the pressure-booster pumps are each connected to a standby power source, or a redundant PLC arrangement to affect the same is acceptable.

8. Where VFDs are used, provide separate VFD for each pump.
9. Local control, alarms, and a remote general fault alarm to building automation systems shall be provided. A low-suction pressure switch with automatic reset shall be provided.
10. An accumulator tank with a diaphragm or bladder may be considered for lab facilities, but is not permitted for clinical applications or cases where microbial control (such as *Legionella*) is of elevated concern. Such tanks (where provided) shall be insulated to maintain cold conditions within the vessel. Alternative sequencing techniques, such as combination immersion flow sensing with backup pressure sensing is generally preferred.

### 8.3.5 Building Water System: General Design Criteria

**A. Design and Construction Criteria:** Each distribution system and all equipment and materials specified by the A/E shall be to potable water standards. Refer to [Section 8.1 Plumbing General Requirements](#) for required distribution piping arrangement.

**B. Materials Standards:** Comply with recommendations of the Copper Development Association (copper), Nickel Institute (stainless steel), Ductile Iron Pipe Research Association (ductile iron).



**Table 8.3.5 Water Distribution Systems Pipe Sizing**

Type	Sizing Parameters
Copper hot and cold water pipe	1.8 m/s (6 ft./s) maximum velocity. Pressure loss due to friction shall not exceed 24 kPa per 30 m (3.5 psi per 100 ft) for mains. Pressure loss due to friction shall not exceed 1.8 m/s (6 ft./s) 35 kPa per 30 m (5 psi per 100 ft) for branches.
High temperature hot water > 62°C	1.2 m/s (4 ft./s) maximum velocity. Pressure loss due to friction shall not exceed 24 kPa per 30 m (3.5 psi per 100 ft).
Hot water recirculation, all materials	1.2 m/s (4 ft./s) maximum velocity. Pressure loss due to friction shall not exceed 2.4 kPa per 30 m (3.5 psi per 100 ft).
Soft water ( $\leq 60$ mg/L as $\text{CaCO}_3$ )	1.2 m/s (4 ft./s) maximum velocity. Pressure loss due to friction shall not exceed 2.4 kPa per 30 m (3.5 psi per 100 ft).
Stainless steel hot and cold water supply and return pipe	0.61 m/s (2 ft./s) minimum velocity, 2.43 m/s (8 ft./s) maximum velocity. Pressure loss due to friction shall not exceed that required to conform with <i>DRM</i> requirements to provide required pressure at use points.

**C. Control of Temperature:** Piping systems shall be properly insulated. Refer to [Section 6.4: Thermal Insulation Systems](#). Cold water systems and appurtenances shall be kept cold (below 20°C [68°F]) and away from heat sources, such as steam piping (regardless of insulation). Hot water systems shall be maintained at approved design distribution temperatures. Water temperatures shall be compatible with connected equipment, materials, and required pressure ratings.

*Rationale: In addition to energy conservation, adequate insulation is necessary to preclude condensation.*

**D. Excessive Temperature of Cold Water:** For areas where incoming cold water temperatures exceed 20°C (68°F), a risk assessment shall be performed to assess the need for additional microbial controls. In all cases water shall be reliably controlled within the parameters of the SDWA. Where cooling is required, double wall heat exchangers shall be used.

*Rationale: Water temperatures above 20°C/68°F can promote rapid microbial growth, including, but not limited to Legionella and may not meet requirements of lab/ARF equipment. A risk assessment should be conducted based upon the water application, presence of population at increased risk, aerosolization, risk to research, etc.*

**E. Pressurized Systems:** Distribution systems shall be maintained pressurized to the point of use. Avoid conditions which may introduce contaminants or air.

**F. Distribution System Sizing Overage:** Pipe mains shall be designed for the maximum calculated flow at the design stage and to provide a 20% allowance for future expansion. A 13 mm (0.5 in.) supply main or branch shall not serve more than one fixture. Water-pipe sizing shall conform to the requirements in [Table 8.3.5 Water Distribution Systems Pipe Sizing](#).

**G. Design Criteria:** The design criteria for each type of space shall be established on a per-program basis in consideration of pressure and flow requirements for the most demanding applications, and shall be documented in the BOD.

**H. Distribution Concept:** Piping systems shall be arranged as main supplies or ring mains (single or double fed as required) with branch run-outs to individual rooms or room groupings. The use of serpentine distributions, in line orifice plates or venturis, and remote placed central manifolds requiring extended individual fixture branches is unacceptable. Circulated systems shall utilize direct-return or reverse return concepts with dedicated horizontal return mains to serve each supply main and riser. Within individual program areas, piping to any fixture subject to infrequent use shall be arranged downstream of branch connections serving frequently used outlets (or provided with recirculation) to ensure fresh water turnover.

**I. Distribution Sizing:** The system distribution design shall utilize appropriate fixture unit values, with the cold water system mains, risers, and major branches sized based on flushometer system curves or other approved engineered methods as required to adequately address demand. Equipment with a significant draw demand (such as cage washers and autoclaves) shall be sized to accommodate peak operating demand flow rate without application of diversity, and proper consideration of any peak or simultaneous demands and facility throughput. Sizing methods shall not impose undue limits on system flexibility (such as limiting operating hours of equipment or procedures over the life of the facility) or unacceptable velocity or pressure loss. It is not acceptable to apply diversity to fixture unit loads or to otherwise apply diversity on top of diversity. Constant flow demand tabulations with application of peak throughput and simultaneous use calculations may be applied where substantiated and approved. The effect of available equipment options on equipment published equipment loads must be verified prior to sizing. For major equipment (especially autoclaves, cage and tunnel washers) the actual equipment as procured shall be verified compatible with piping system designs prior to piping installation.

***Rationale:** When applying fixture unit values, the use of the higher flow rate conversions of flushometer curves or throughput calculations may better simulate demands imposed upon the system from laboratory equipment, however in some cases actual peak flow demands are required. In many cases lab equipment (such as autoclaves) throughout the facility and cage wash equipment can be used simultaneously. It is important when applying flow rate demands to consider the difference in operation frequency between high flow equipment demands (such as primary fill for equipment) which may not occur on a constant basis, and generally constant on-going equipment demands (such as rinse cycles). Equipment options can cause significant variations in utility loads.*

**J. Hot Water Systems Sizing:** Hot water systems may be sized on the basis of flush tank curves, except that mains and runouts serving major equipment or items with a significant relative draw demand shall be sized

similar to requirements for cold water systems. The use of actual flow rates or flow rates with a justified value based upon a calculated throughput diversity may be used where appropriately applied.

***Rationale (for General System Sizing Methods):** Application of Hunter's Curve needs to be compared with actual fixture/equipment-demand profiles to identify the water-flow quantity and associated demand condition of the facility. Special demands (such as simultaneous use major equipment), are added directly to calculated flow requirements without diversity, but may consider throughput calculations that are not based on potential variable program operating schedules.*

**K. Minor Water Branch Line:** Where a minor water branch line or runout serves only fixtures such as sinks, lavatories, etc. (no flushometers, major equipment, or high-use volume outlets on the line), the line may be sized on the basis of flush tank curves, provided the complete required hydraulic design criteria are met, including velocity and pressure-loss limitations.

***Rationale:** This is to prevent unnecessary over-sizing of branch lines that can occur from unweighted application of uniform loss curves.*

**L. Constant Flow and High-Demand Requirements:** The demand of any constant flow mechanical requirement, process requirement, or other and significant constant flow load, including but not limited to mechanical water loads shall be taken without diversity. Diversity may be applied to initial quick-fill requirements for systems as warranted.

**M. Emergency Showers/Eyewashes:** The flow rate of the maximum design quantity of emergency showers and eyewashes shall be included in the sizing of water system piping and equipment. Emergency eyewash and emergency shower demand flow rates need not be added to the plumbing water demand for purposes of sizing the combined incoming plumbing/fire water service.

***Rationale:** This is to ensure the constant availability of required water flow rates for emergency fixtures.*

**N. Hydraulic Shock and Surge Control:** Water hammer arrestors (WHA) shall be provided at all quick closing valves and other potential shock sources, including shower faucets, hose stations, flushometer branches, ends of long branches subject to hydraulic shock, and required equipment connections (including but not limited to cage wash, labware wash, and autoclave equipment). Water hammer arrestors shall be sized in accordance with Plumbing & Drainage Institute (PDI) guidelines, including upsizing of arrestors for systems operating above 410 kPa (60 psi) or by engineered analysis. The location and size of water hammer arrestors shall be indicated on drawings. No intervening valves devices, or backflow preventers may be present between the shock source and the water hammer arrestor. Pumps shall be selected and arranged to protect from over-pressurization. Slow-close valves, anti-surge valves, and hydropneumatic cushions shall be used where required to prevent failures. Water hammer arrestors shall be of a permanent type that does not require routine service or replacement. WHA's for high flow process applications (e.g., cagewashers, tunnel washers) shall be sized based on engineered analysis to determine the required volumetric capacity and peak spike pressure to be attenuated. The allowable post-attenuated system pressure spike shall not exceed 1034 kPa (150 psig) and arrestors shall have a spike pressure handling capability of at least 2413 kPa (350 psig). Vacuum arrestors/specialty vacuum breakers shall be provided where column separation (cavitation) induced water hammer conditions cannot be avoided.

**O. Automatic Air Vents:** Automatic air vents shall be provided where the arrangement of the distribution system will not ensure the release of air from normal plumbing fixture use or could result in a trapped air pocket or unsafe condition. Where automatic air vents are required, they shall be placed at the high point in the system in a mechanical room or similar space, and routed to drain with an air gap. Vents shall be readily accessible, and shall not be located above ceilings or concealed. Vent arrangements shall not be extended in such a manner as to create dead-legs. Air pressure relief is preferably accommodated automatically by arranging the top portion of systems for automatic air withdrawal during fixture use.

**P. Mixing valves:** Mixing valves that present a constant or extended open path for cross flow of hot and cold water shall be provided with check valves on both hot

and cold supply inlets (e.g., thermostatic and mechanical tempering valves, hose stations, and shower valves). Check valves shall incorporate durable stainless steel or brass gates.

**Q. Hot and Cold Water Pressure Gauges/Thermometers:** Multistory buildings shall include process grade pressure gauges on hot and cold water and thermometers on hot water and hot water circulation take-offs from main risers on each floor. Gauge cocks and temperature wells shall be provided.

### 8.3.6 Backflow Protection

**A. Design Approach:** The design intent for water supply to the ARF and lab facilities is to minimize provision of testable backflow preventers within laboratories, ARFs, and other sensitive areas. This shall be accomplished through use of dedicated laboratory water systems that are isolated from potable supplies. See [Table 8.3.6](#).

1. Regardless of systems segregation, it is required that water quality be maintained at very high levels of safety and any risks to system water quality (including risks to potability) be controlled and minimized. Water quality is maintained within these subsystems by devices commensurate with the risk and intended application of these systems.
2. Typically, adequate protection of lab water systems at points-of-use shall be accomplished through use of an approved, non-testable backflow preventer; however, even where supplied from laboratory water, high hazard type protection devices or testable devices may still be required locally commensurate with a particular risk.
3. Certain system applications require potable supplies that shall be arranged and protected in accordance with plumbing code and cannot be served by lab water.
4. The A/E shall comply with specific restrictions (beyond code requirements) as to type, quantity, and placement of additional or varied backflow preventer arrangements such as for high containment that are addressed in the corresponding

section of the *DRM*.

**B. Additional Requirements:** Facility isolation and local containment of high hazards is required. Additional design requirements include:

1. Unprotected potable water shall not be extended into labs.
2. Assessment of the potential hazard is required for each use point.
3. Ensure the appropriate water supply is readily available to all areas of the facility.
4. Proper identification and labeling of specific piping system contents and areas served to minimize risk of future inadvertent cross-connection.
5. BFP's shall conform to applicable ASSE, AWWA, or USC FCCCHR standards.
6. Water outlets served by lab supply shall have permanent signage in conformance with plumbing code requirements or as otherwise approved by DOHS. An example of signage that may be approved is "LAB WATER, DO NOT DRINK".

**C. Backflow Preventer Installation:** The installation of each backflow preventer (BFP) and the type of device applied shall be justified by risk. The A/E shall consider the annual maintenance and service requirements for testable devices, and ancillary requirements such as drains, trap primers, etc. BFP's shall be unconcealed, above ground, and readily accessible except that non-testable devices (where suitable) may be located within casework. Pressure type vacuum breakers, including spill-resistant vacuum breakers must be installed with a constant pressure on the upstream (supply) side of the device to preclude discharging and shall not be applied in interior low-flow conditions where checks may not seal prior to leakage (e.g., fume hoods).

**D. Service Clearance and Drainage:** Backflow preventers shall be provided with proper service clearances and adequate drainage. Device placement and drainage provisions shall consider that some devices may leak or spill under normal operation. Provisions shall be made to accommodate the peak relief valve discharge flow rate as obtained from the backflow preventer manufacturer's product data in consideration of the peak incoming water supply pressure. Where ASSE 1013

reduced pressure zone (RPZ) devices 40 mm (1.5 in.) and larger are used, the A/E shall demonstrate that the drainage system can pass the maximum possible flow rate through the relief valve of the device, and where it cannot, shall provide independent automatic shut-off and alarms to prevent flooding of the building from an open relief valve under peak discharge conditions. Comply with the following requirements:

1. Where necessary because of the quantity of water that could be discharged relative to drain system capacity and location of a reduced-pressure principal device, an automatic shut-off and alarm signal to BAS shall be provided that activates upon a predetermined minimum flow rate of discharge through the relief valve. Automatic shut-offs shall function independently for each device, shutting off only the single affected backflow preventer to allow continued water supply through the second parallel device in the event of malfunction. Flow switches utilized for activating automatic shut-off devices shall be of corrosion-resistant construction.
2. Even where automatic shut-off devices or other provisions are provided, devices shall be arranged and piped to permit normal spillage to a floor drain or floor sink through the manufacturers' air gap without causing nuisance tripping of the relief valve flow sensor.

*Rationale: Discharge from backflow preventers can produce substantial water flows beyond carrying capacity of drains, and resultant water damage. Even when located in mechanical rooms, substantial discharge through relief valves may overwhelm drainage receivers, or spill beyond intended areas.*

**E. Automatic Shut-Off Arrangements:** Where automatic shut-off arrangements are provided on water supplies to critical applications (such as whole building lab water), the valve closure device shall fail in the open position, and only be applied in applications where redundant backflow preventers are incorporated and include a system emergency alarm to BAS feature. Devices shall require manual reset to protect from flooding upon reactivation. Automatic shut-off arrangements shall not be utilized on water supplies for fire protection systems.

**Table 8.3.6 Backflow Protection**

Item	Required Device when Fed from Lab (Isolated) Water System
Faucets in lab, animal research facility, and cage wash	ASSE 1001 AVB (vacuum breaker) faucet spout
Fume hoods	ASSE 1001 AVB mounted high on an exterior face of hood, exposed with no downstream valves or back-pressure. ASSE 1056 may be used only where under continuous inlet pressure unless manufacturer certifies diaphragm seal will not leak in low-flow application.
Hose stations (water type)	ASSE 1011 HBVB, ASSE 1001/ASSE 1056 AVB/SVB installed per listing, ASSE 1015 DCVA or ASSE 1024 dual check, or approved integral device at hose station.
Hose station (water × steam or water × chemical)	ASSE 1013, local or grouped. See <a href="#">Section 8.2 Plumbing Fixtures and Equipment</a> .
Laboratory ice machines	None required. Water-cooled units provide with check valve.
Undercounter labware washer designed with integral backflow preventer or air gap	None required
Undercounter labware washer, with no suitable integral backflow control	As a minimum ASSE 1024
Cage/rack/tunnel washers	ASSE 1013 RPZ
Wash Equipment Utilizing Chemicals without a listed backflow prevention design (such as integral air gap)	ASSE 1013 RPZ
Necropsy/downdraft sinks and tables	ASSE 1001/ASSE 1056 vacuum breakers or ASSE 1013 RPZ, installed per listing. See <a href="#">Section 8.2 Plumbing Fixtures and Equipment</a> . ASSE 1056 only where under continuous inlet pressure.
Point of use water purification	None required
Laboratory autoclave	ASSE 1012 DCIAV or ASSE 1015 DCVA
Liquid ring lab vacuum pump	ASSE 1013 RPZ
Low hazard potential, non-toxic connections	None required or check valve
Moderate hazard potential, non-toxic connections	ASSE 1012 DCIAV, ASSE 1015 DCVA, ASSE 1024 dual check
High hazard potential of toxic, pathogenic, or dangerous connections	Air Gap, ASSE 1013 RPZ, ASSE 1001/ASSE 1056 per listing. For high containment (BSL-3 and above), refer to other sections of <i>DRM</i> .

**Abbreviations:** RPZ = reduced pressure zone backflow preventer; AVB = Atmospheric Vacuum Breaker, Pipe-Applied; DCIAV = Double Check with Intermediate Atmospheric Vent; DCVA = double check valve assembly; HBVB = Hose Bibb Vacuum Breaker; SVB = spill resistant pressure vacuum breaker



**F. Hose Thread Outlet Backflow Protection:** All low point drains that are equipped with hose pattern threads, and other devices with hose pattern threads that are connected to any potable water system shall be provided with ASSE 1011 hose bib vacuum breakers and a hose cap or ASSE 1019 arrangements, unless such outlet is directly protected with another approved upstream backflow preventer arrangement. Where a hose bib is provided near any sewage pump, laboratory waste treatment system, or within any liquid waste decontamination system or tissue digester room the water supply to the space shall be provided with a RPZ backflow preventer. Hydrants shall comply with requirements in [Section 8.2 Plumbing Fixtures and Equipment](#).

***Rationale:** Inadvertent tripping or malfunction of a single device or flow sensor, loss of power or restoration of the power supply must not impact water supply.*

**G. Bypass Arrangements:** Bypass arrangements shall not be permitted around backflow preventers.

***Rationale:** Only the use of redundant (parallel) backflow protection is acceptable where continuous service is necessary so as not to compromise cross-connection control.*

**H. Backflow Preventer Log:** The A/E shall specify that the contractor shall provide a BFP log to NIH at the conclusion of a project indicating the exact location, type of device, brand, model, serial number, and service function for each backflow preventer that requires annual testing (any device provided with test cocks, such as double-check valve assemblies, reduced pressure principal devices, pressure vacuum breakers, etc.). This log shall be included in project close-out documents, and shall be provided both electronically in Excel, PDF, and also where printed documents are issued and shall be included in O&M manuals in printed format. The NIH reserves the right to furnish specific forms or data files for this purpose, and to assign specific device numbers or nomenclature which shall be utilized by the contractor in preparing logs and test reports.

**I. Backflow Preventer Testing:** The A/E shall specify that upon installation, each backflow preventer shall be

tested for proper operation in accordance with ASSE series 5000, AWWA, or USC FCCCHR standards by an ASSE or ABPA certified cross-connection control device tester. Any device that fails the performance requirements shall be repaired and retested. A copy of the test results shall be included in the project close-out documents with the device location log. Testing shall be provided at project close-out, prior to project turnover or no earlier than 60 days from project turnover as approved by the PO.

### 8.3.7 Emergency Fixture Water

**A. Potable Water Systems:** Emergency shower and eye-wash fixtures shall be served from potable water systems per ANSI Z358.1 and incorporate backflow protection and proper identification to safeguard the potable water supply. New facilities and renovations shall include potable water distribution with ASSE 1013 backflow protection to serve emergency fixtures in accordance with this section.

1. Eyewash and shower fixtures that are located outside of the laboratory or ARF zone may be fed directly from potable water without additional backflow protection, providing the fixture is appropriately designed to preclude backflow. A local point of use ASSE 1071 thermostatic mixing valve with integral cold water bypass shall be provided at each fixture.

Where a service line must be extended, the piping shall be sized and arranged as for a new installation in accordance with this section of the *DRM*. Flushing point may return to a janitor closet mop sink where a suitable indirect waste receptor is not available in existing construction.

***Rationale:** Lab systems may be subject to a variety of hazards that may compromise potability upstream of backflow preventers. ASSE 1013 BPF ensures isolation of lab water outlets from upstream potable system, especially in the event of unauthorized tappings or cross-connections.*



**B. Tempering:** Water tempering is required in compliance with ANSI Z358.1; however, such tempering shall be provided at the low-end of the ANSI-defined tepid range. A temperature of 15.5°C–18.3°C (60°F–65°F) shall be provided.

*Exception:* For fixtures outside of laboratories and not located within the laboratory or ARF zones and associated corridors that are fed directly from potable hot and cold water with point of use mixing valves and minimal dead-legs, tepid water within the full ANSI-defined tepid-water range is acceptable as appropriate to the application. For off-campus projects at locales where the incoming cold water temperature exceeds 15.5°C (60°F) during the coldest season as recorded in municipal published water reports, no tempering is required. However, where water exceeds safe temperature ranges, microbial control or other regulation may be required based upon a risk assessment.

*Rationale:* Emergency water systems do not achieve routine usage or water turnover, and at temperatures above 20°C (68°F) can be susceptible to microbial contamination.

**C. Design Arrangement:** Emergency fixture water shall be connected from an adequately sized potable hot and cold water riser serving each floor/wing. A local ASSE 1071 thermostatic mixing valve with cold water bypass and an ASSE 1013 backflow preventer arrangement (N + 1 for the BFP) shall be provided. Piping downstream of the isolating backflow protection when necessary shall be identified as “Emergency Fixture Water.” Centralized “tempered” water systems serving multiple floors or multiple building wings or areas are not acceptable. Mixing valves shall be equipped with locking temperature adjustment properly set, and shall be located in a secure lock box or with other secure means to preclude tampering, commensurate with the device location. Emergency fixture water piping shall be insulated to protect from ambient or hot-surface contact temperature rise and condensation. Recirculation back through any heater is unacceptable.

*Rationale:* Even with circulation back to heaters for reheating, microbial proliferation in piping can occur and be subject to scalding risks due to slow temperature climb in the systems as well as inadequate flushing and potential compromise

*of required facility backflow protection for supplies to labs. Water maintained at minimal temperatures through on-floor mixing stations, BFP’s and flushing along with maintenance of residual disinfectant maintains flexibility, minimizing complexity, safety risks, and maintenance issues.*

**D. Avoidance of Dead-Legs:** The A/E shall locate emergency fixture water mains and run-outs to minimize dead-legs. Such piping should generally be located above the labs or in service corridors, providing a loop as necessary to minimize length of run-outs to fixtures and maximize flexibility.

*Rationale:* By arranging piping in this manner, mains can be readily flushed automatically and the short branch lines receive flushing and turnover during routine testing.

**E. Automatic Flush of Main:** The end of the emergency fixture water main at each floor shall serve at least one commonly used, cold water fixture of adequate use and volume, preferably a single, normally used flushometer water closet. Multiple sinks (not lavatories or mop sinks) or other fixtures may also be used provided sufficient flow rate and turnover is routinely achieved; however, this is only acceptable (a) where a serving water closet is not in proximity, (b) other approaches cannot be reasonably implemented, and (c) it can be reasonably determined that sufficient water turnover for piping main contents will occur at intervals of at a daily or not to exceed every second day basis. Within the wall, an identification tag to identify the pipe line shall be provided that reads as follows:

*“Operation of this fixture serves to purge emergency fixtures on this floor. Notify project officer of this warning tag if modifying this piping or removing this plumbing fixture.”*

*Rationale:* Routine plumbing fixture operation provides an efficient means of turnover of this water line.

**F. Automated Water Purge:** In cases where there is no suitable normally used plumbing fixture on the floor

served, the A/E shall provide a BAS actuated line purge at the end of the supply main for the floor, which shall discharge to an indirect waste receptor at a rate of at least 57 L/min (15 gal/min) or as necessary to provide a 0.6 m/s (2 ft./s) velocity in the main for sufficient duration to turnover all contents in the water line on a daily basis. A pressure-compensating flow restrictor shall be provided on the purge to limit the volume within allowable calculated parameters.

**G. Flush Capacity per Fixture:** A single water closet of 6 liters per flush or less (1.6 gpf or less) flush capacity shall not serve more than 136 liters (35 gallons) of piping system volume, unless the fixture is in a high usage area where it can be reasonably calculated that complete water turnover of system contents will occur on a daily or in no case to exceed an every second day basis. Where this is not possible, multiple fixtures (with adequate size mixing valve), or use of an automatic purge, or supplemental automatic purge will be required.

**H. Distribution Main Area Limitation:** The horizontal distribution loop and end-of-line purge for emergency fixture supply mains shall be independent to serve only a single floor within a single building wing.

*Rationale: This is to ensure that each floor and building wing can be independently isolated for maintenance and to ensure adequate flushing and disinfectant residual.*

**I. Emergency Fixture Size:** Mixing valve and piping serving emergency fixtures shall be of adequate size to supply the maximum quantity of emergency fixtures to be in simultaneous use, but not less than at least the flow rate of the single most demanding emergency fixture group (consisting of at least a single emergency shower plus a single emergency eyewash) plus the total simultaneous flow of the flushing purge fixture. The minimum acceptable size for distribution mains is 40 to 50 mm (1.5 to 2 in.) (dependent on facility size), and the minimum size branch line to a single emergency shower is 32 mm (1.25 in.), and a 13 mm (0.5 in.) branch shall be provided to serve each emergency eyewash. Flow velocity under conditions of maximum design simultaneous use may be up to 3 m/s (10 ft/s) in the main, but shall not exceed 6 ft/s during normal fixture usage. Residual

pressure at emergency fixture outlets shall be at least 240 kPa (35 psi). Selection of the mixing valve shall be made additionally with consideration of the flow rates from of a single eyewash/facewash fixture to provide adequate temperature control.

**J. Isolation Valves:** Isolation valves on emergency fixture water supplies shall each be labeled and locked open, or located in a secure area and appropriately labeled. Mixing valves and backflow preventers serving such systems shall be located in a controlled area and shall be appropriately labeled or locked to prevent tampering.

**K. Required Alarms:** A low pressure transmitter shall be provided at the end of the emergency fixture supply main at each floor and shall alarm to BAS if pressure in the main drops below 207 kPa (30 psi). Systems shall be hydraulically designed in consideration of residual pressure under demand condition to preclude false alarm tripping. A high temperature alarm shall be provided at the end of the emergency fixture supply main at each floor (after the mixing valve), and shall alarm to BAS if water temperature exceeds 35°C (95°F).

### 8.3.8 Hot Water Systems

**A. Water Heaters:** Water heaters shall be semi-instantaneous, shell & tube steam type with modulating fail-safe pneumatically actuated valves with electric control, or electric (not pilot self-actuated) modulating fast-positioning with position-feedback type, control valves, with immersion-sensors and a solenoid safety system. Temperature control shall be accurate over entire flow range within plus or minus 2°C (4°F). The process hot water shall be located and temperature sensed within the shell and provided with integral internal forced circulation. Shell shall be solid copper-nickel construction or comparable corrosion resistant material (such as duplex stainless steel alloy), tubes and tube sheet of copper or copper nickel alloy, and suitable for potable water. 1/3–2/3 control valves shall be provided except they are not required for low-pressure steam control valves smaller than 50 mm (2 in.) size. Where steam is not available, equivalent heaters but supplied with high temperature heating hot water is acceptable. Hot water production systems serving high flow on/off applications (such as cage wash) shall incorporate a copper nickel, cement-lined, or duplex grade stainless steel storage tank sized

to accommodate at least five minutes of the peak hot water demand.

*Rationale: This type of equipment is preferred for proven reliability, durability, microbial, and temperature control.*

**B. Tank-Type Heaters:** Electric, oil, or gas-fired, storage tank-type heaters may be employed only for special applications as approved by the ORF, such as where steam or adequate high temperature heating water is not available for the facility. Steam is the preferred energy source for water heating at the NIH Bethesda campus. Off-campus equipment shall be selected to ensure reliability, longevity, efficiency, and adequacy of hot water supply. Where tank-type heaters are utilized for central hot water production in labs and ARFs, tanks shall be cement-lined, copper-lined, copper-nickel, or duplex grade stainless steel selected for appropriate long-term corrosion resistance. Polymeric linings and coatings are not acceptable for heated vessels, except for administrative/office applications. Hot water tanks may be approved for limited applications where justified, including for limited local applications where other approaches are impractical. This restriction does not apply to integral buffer tanks up to 378 liters (100 gallons) each of semi-instantaneous style heaters or lab water heaters for cagewash. Water heater tanks larger than 120 gallons storage shall include a dedicated constant tank circulator pump.

*Rationale: Tank restrictions are for microbial control and reliability.*

**C. Heater Size/Arrangement:** Heaters shall be sized and arranged to provide N + 1 redundancy for the total design load.

**D. Steam/Fuel Supply Overage:** Steam/fuel supply to heaters shall be sized for full demand plus 20% allowable for growth.

**E. Hot Water Temperature:** Hot water shall be heated to 60°C–63°C (140°F–145°F) and tempered down to 52°C–54°C (125°F–130°F) for general potable water system distribution by ASSE 1017 master thermostatic mixing valves. See [Section 8.3.9 Hot Water Circulation and Temperature Maintenance](#), [Table 8.3.8 Minimum](#)

[and Maximum Hot Water-Outlet Temperatures](#), as well as [Section 8.3.10 Hot Water System Temperature Control and Over-Temperature Protection](#).

*Rationale: This is to ensure lowest temperatures in the system are maintained above 50°C (122°F) for microbial control, including Legionella.*

**F. Distribution, Lab Systems:** Distribution to achieve 55°C–60°C (131°F–140°F) is acceptable for lab and ARF areas. In no case shall lab water temperature distribution be less than required for potable water systems in the *DRM*.

**G. Local Thermostatic Protection:** Local (point of use) thermostatic protection should be provided for special applications as required for safety or special use. Locate immediately at the individual fixture/faucet supply connection with absolute minimization of downstream tempered water piping length. Where feasible, select faucets with integral mixing/thermostatic protection. Single thermostatic valves serving groups of fixtures is unacceptable for any application where outlet temperatures will be below 50°C (122°F).

**H. Hot Water Storage and Production Temperature:** Wherever hot water is produced or stored, the storage temperature shall be at 60°C–63°C (140°F–145°F) except where higher temperature storage is required for specific applications. Where large tank arrangements over 380 liters (100 gallons) are required, they shall be arranged to minimize stagnation through pumped circulation of tank contents (provision of a tank circulator).

*Rationale: This is to provide control of microbial growth in water tanks. Water is blended to lower temperatures for general distribution.*

**I. High Temperature Applications:** Any application requiring hot water production and storage at temperatures of 71°C (160°F) and above shall be dedicated to that function.

**J. Shared Water Heaters:** Recirculation of non-potable or subsystem fluid shall not be permitted through the water heater. Water heaters shall not be a point of mixing of varying fluid qualities. Where a shared water heater is utilized to serve multiple systems, each system

shall include its own thermostatic temperature mixing valve assembly.

**K. Booster Heaters:** Point of use booster heaters at the kitchen dishwasher, cage washer, etc., shall be used where water temperature above 60°C (140°F) is required.

*Rationale: Final rinse water (typically 82.2°C–87.7°C [180°F–195°F]) may be most economically and safely accommodated through point of use booster heaters.*

**L. Multi-Pressure Zone, Remote Mixing Valves:** For large facilities with multiple pressure zones, hot water may be distributed at 60°C (140°F) with local master thermostatic mixing valves applied at each pressure zone to reduce distribution temperature to not below 52°C (125°F) prior to outlets in lieu of locating the thermostatic control valve directly at the water-heater source equipment.

**M. Master Thermostatic Mixing Stations:** Master thermostatic mixing stations are required where hot water is produced or stored above 60°C (140°F) and where the hot water production equipment does not include reliable and sensitive temperature limiting controls designed to be accurate within 2.2°C (4°F) of set point and is inclusive of solenoid safety systems; or where systems may be subject to uncontrolled temperature excursion; or where deemed necessary for scald protection. Refer to [Section 8.3.10 Hot Water System Temperature Control and Over-Temperature Protection](#). Master Thermostatic Mixing Stations are not automatically required for laboratory systems, supply to cage wash, or for potable hot water to commercial food service production areas, but may be provided where appropriate.

**N. Cage Wash Equipment:** ARF cage wash equipment shall be provided with independent water heaters, served from the lab cold water system, with 60°C (140°F) distribution to cage wash equipment. The cage washer water heaters may also serve the clean/dirty cage wash areas. Water to cage wash equipment typically requires scale control. Refer to [Section 8.3.12 Corrosion Protection, Water Treatment, and Control of Scale](#).

**O. Microbial Control:** Potential for *Legionella* or other microbial control issues in water-distribution systems shall be considered and appropriately addressed based on risk assessment. Disinfectant systems (such as

chlorine dioxide) are not typically required for lab facilities, but are typically required for protection of potable hot water in large clinical applications serving non-ambulatory patients, the elderly, and those with compromised immune systems. Where chlorine dioxide is utilized, it shall only be applied to the cold water system (prior to heating) and an approved method of generation (e.g., catalytic production or other method to control hazardous chemicals and disinfection byproducts) shall be provided. An approved monitoring protocol shall be developed. The approach utilized and areas served shall be as approved by ORF and DOHS and may vary by disinfectant.

**P. Point of Use Water Heaters:** Point of use water heaters shall not be considered an acceptable substitute for connection to the central building hot water supply and return systems. Services shall be appropriately extended to all areas of the facility.

**Q. Valves/Components:** Valves and components shall be suitable for a normal working temperature of 80°C (176°F) at pressures of 1030 kPa (150 psi) to allow for systems sanitization.

**R. Temperature Adjustments:** The A/E shall specify the proper adjustment of limit stops and mixing valve set points. Critical applications shall be provided with appropriately adjusted point of use thermostatic protection in accordance with the ASSE listing. Temperature at use points shall be in accordance with [Table 8.3.8 Minimum and Maximum Hot Water-Outlet Temperatures](#).

**S. Expansion Tank/Vacuum Relief Valve:** An expansion tank shall be provided on the cold water makeup near to the water heater, downstream of a check valve. A vacuum relief valve shall be provided where the water heater is located one story or more above fixture outlets. Precharge of expansion tanks shall be set prior to system fill. Expansion tanks for all systems shall be approved for the maximum operating temperature of the system (but in no case less than 82°C [180°F]), and shall be NSF-61 compliant.

*Rationale: Placement on the cold side of the system is associated with microbial control and diaphragm/bladder longevity. Vacuum relief is only required where a tank could reasonably be susceptible to a vacuum condition.*

**Table 8.3.8 Minimum and Maximum Hot Water-Outlet Temperatures**

Fixture Type	Min Hot Water-Outlet Temp	Max Hot Water-Outlet Temp
General sinks	50°C (122°F)	51.5°C (125°F)
Cage wash work sinks	57°C (135°F)	62°C (143°F)
Lab/animal research facility area sinks	50°C (122°F)	60°C (140°F)
Cage wash equipment	60°C (140°F)	62.5°C (145°F) (Boosted locally where higher temp required)
Hand wash sinks	50°C (122°F)	51.5°C (125°F), except up to 57°C (135°F) where served from a 60°C (140°F) system and provided the fixture is located within the secure lab or animal research facility program areas. 40°C (104°F) Recommended standard set point for point of use generated tempered water.
Labware washers	55°C (131°F), except where units are specifically selected with heaters and designed for lower inlet hot water temperatures (which in no case shall be less than 50°C (122°F))	62°C (143°F)
Kitchen areas and sinks and dishwashers	50°C (122°F), except 57°C (135°F) minimum required for undercounter dishwashers and 60°C (140°F) minimum required for commercial dishwashers, unless such units include suitable built-in heaters and are designed to maintain sanitization with the lower temperature supply, which shall be min. 50°C (122°F). 57°C (135°F) for commercial food service areas. Refer to <a href="#">Section 8.2 Plumbing Fixtures and Equipment</a> , dishwasher requirements.	60°C (140°F), except commercial food service may be up to 62°C (143°F). Final rinse temp of commercial dishwashers to be boosted locally.
Hose stations	52°C (125°F)	60°C (140°F)
Janitor closet/service sinks	52°C (125°F), except 60°C (140°F) for food service and cage wash areas	60°C (140°F), except 62°C (143°F) for food service and cage wash areas
Public lavatory faucets	40°C (104°F) mixed outlet temperature	43°C (110°F) maximum outlet temp, supplied from hot water of at least 50°C (122°F) delivered to the inlet of tempering valve at fixture location
Sensor actuated faucets	40°C (104°F) mixed outlet temperature, unless requested	40°C (104°F) Typical set point. Flushing cycles (for units so equipped) should be at full hot. Supply from hot water of at least 50°C (122°F) to the fixture location
Showers	N/A	45°C (112°F), Supply from hot water of at least 50°C (122°F) to the fixture location



**T. Heat Exchanger Type:** Heat exchangers (including water heaters) utilized within potable and lab hot and cold water systems shall be of the double-wall type, with a leak detection path visibly vented to atmosphere except that single-wall heat exchangers may be used for lab water systems provided the code provisions for potable water are met and a minimum 69 kPa (10 psi) transfer fluid pressure differential with pressure gradient monitoring, on-toxic transfer fluids, and maximum 69 kPa (10 psi) steam pressure criteria is maintained.

### 8.3.9 Hot Water Circulation and Temperature Maintenance

**A. Continuous Pumped Circulation:** Hot water system temperature maintenance shall be provided for all systems through the use of continuous pumped circulation. Recirculation systems utilizing pipe-in-pipe (such as flow on both the inside and outside of a carrier pipe) are not acceptable. A separate return pipe system shall be provided. Returns of distribution systems operating at different temperatures or pressures shall not be combined.

**B. Circulation Rate:** The required circulation rate shall be calculated for each loop and sized to offset system heat losses. The A/E shall indicate the required flow rates for each circuit on the design drawings.

*Rationale: Flow rates are correlated to the adequacy of thermal piping insulation. Continuous circulation is required to limit cooling and stagnation.*

**C. Distribution Arrangement/System Design:** Systems shall be designed as direct return or reverse-return-type only, utilizing horizontal distribution arrangements consisting of a supply and return branch take-off from a parallel horizontal supply and dedicated return main to serve each laboratory, fixture branch, or room of each floor, independent of other floors. Systems shall be arranged such that hot water may be shut off independently to each space without affecting flow through other spaces. Systems shall be arranged such that

additional fixtures may be individually tapped from supply and return branches serving adjacent areas without requiring rerouting of piping mains. Vertical distribution arrangements, with the exception of central main risers serving an entire floor or wing, are prohibited.

**D. Serpentine Distribution:** Serpentine-type hot water distribution, or the arrangement of hot water circulation in a single supply loop with the return taken only at the end as an extension of the horizontal fixture supply loop or through similar arrangements, is not allowed. Within single individual rooms or single laboratories, serpentine distribution may be utilized where the main hot water branch serving the space is centrally located within the room to provide flexibility for future connections and the end of that serpentine branch connects back to a dedicated direct return or reverse return horizontal main.

**E. Hot Water Wait Time & Configuration:** Each hot water supply branch shall be constantly circulated back to the hot water return and fitted with an appropriate shut-off valve, fixed or variable orifice type balancing device with P/T ports, and check valve to maintain hot water to fixtures within the recommended time criteria as outlined by ASPE, generally within 15 seconds. Faucets with outlet rates below 5.7 lpm (1.5 gpm) shall have the entire hot water fixture branch line recirculated.

**F. Riser Balancing Station:** The hot water return rate required for each riser should be maintained by provision of a balancing station at the top of the riser where the supply riser loops back to the return riser.

**G. Floor Balancing Station:** The main hot water return from each floor shall be provided with a flow-limiting floor-balancing station, even where local circuits are individually balanced, set to limit the maximum return-water flow that will be allotted to serve a single floor. A thermometer shall be included at the end of each floor's hot water-return connection to the riser.

*Rationale: The use of on-floor flow-limiting balance stations is to ensure limit flow rates on a single floor so adjustments of individual circuits will not significantly displace required flow rates throughout the whole facility.*



**H. Automatic Balancing Valves:** Automatic and thermostatic type balancing valves are not permitted.

**I. Heat Tracing:** Heat tracing is not permitted as a substitute for provision of central building hot water circulation.

**J. Sizing Criteria:** Hot water return systems serving cage wash areas and kitchens shall be sized for a 3°C (5°F) temperature differential. General building areas shall be sized for a 4°C (7°F) maximum differential. The A/E shall be cognizant of the pressure differential required for proper adjustment of balancing valves. A minimum flow of 1.9 L/min (0.5 gpm) shall be provided with a 13 mm (0.5 in.) pipe size unless lower flows are confirmed within the effective control range of the selected balancing device. Reduced-size balancing valves applied to larger-diameter returns may be provided (and are recommended) where justified by the required flow rate to afford proper control, subject to acceptable velocity limitations. Recirculation pumps shall be two in parallel, each sized for 50% flow at the required head, with flow based upon the allowable maximum temperature differential from system heat loss, and both online. Pumps serving systems operating at temperatures 60°C (140°F) and below shall provide continuous system recirculation, without aquastats or timers.

**K. Independent Recirculation Zones:** Each pressure zone shall be provided with its own circulation pump and heat-loss-recovery means specific to that pressure zone. The use of pressure-reducing valves, orifice plates, balancing valves, remote pressure sensing and other means shall not be permitted as a means to balance pressures for interconnections between zones. There shall be no recirculation through pressure-reducing valves in any closed loop arrangement, (including in hot water-recirculation systems) such as between the high-pressure and low-pressure sides of the PRV, or through any arrangement that can compromise pressure control.

***Rationale:** These requirements ensure appropriate pressure, temperature and microbial control and proper operation of water-circulating systems, while maintaining flexibility for system extensions, modifications, and pressure balance.*

## 8.3.10 Hot Water System Temperature Control and Over-Temperature Protection

### A. Temperature Control:

1. ASSE-1017 listed devices shall be provided at the hot water source of all domestic-water-heating systems as well as all systems that are produced from a heat-transfer fluid which operates at a temperature at or above 71°C (160°F). The devices shall be arranged in parallel to provide N + 1 redundancy for continuous service. Only hot water to commercial food service, laundry, cage wash equipment, or other approved institutional applications are exempted subject to conformance with *DRM* and plumbing code. Where mixing valves are electronic type, only fully redundant units that maintain continuous operation (including under conditions of electrical power outage) may be utilized. Monitoring a controller fault to BAS is required. Connection to standby power is required. UPS is required and shall be sized for not less than eight hours systems operation at the normal operating ambient temperature where installed. Regardless of type, all master mixing valves and high-low systems shall be selected and designed to ensure normal use of each valve without stagnancy and to maintain an acceptable balance between delivered hot and cold water supply pressures.
2. All mixing valve assemblies shall be sized to maintain proper temperature control under all demand flow conditions.
3. The ASSE-1017 devices shall be arranged and set to limit temperatures at the outlet of the valve to a maximum of 60°C (140°F) where serving domestic plumbing fixtures and laboratory equipment, such that the temperature at use points complies with the requirements given in [Table 8.3.8](#).

**B. Maximum/Minimum Temperatures:** For general potable water distribution throughout the facility, water temperature at the mixing-valve outlet shall be set at 52°C–54°C (125°F–130°F) so the temperature at use points complies with the requirements given in [Table 8.3.8 Minimum and Maximum Hot Water-Outlet](#)

**Temperatures.** The temperature at any point in any hot water piping system shall not fall below 50°C (122°F); and distribution temperature up to 60°C (140°F) is acceptable where point of use thermostatic protection is provided to comply with the requirements of [Table 8.3.8 Minimum and Maximum Hot Water-Outlet Temperatures](#) or as required by plumbing code.

**C. Temperature Set Point:** A maximum set point of 60°C (140°F) may be provided for distribution of lab water to lab and ARF areas.

**D. Food Service and Cage Wash Areas:** Potable water at 60°C (140°F) shall be distributed to food service areas and equipment, and lab water at 60°C (140°F) shall be distributed to cage wash areas.

**E. Master Thermostatic Assembly:** The use of only a single high–low master thermostatic assembly is acceptable for lab, ARF, and administrative facilities, provided the following conditions are met:

1. Supply temperature to the mixing valve is not over 60°C (140°F).
2. The hot water source includes fail safe protection to prevent distribution of over-temperature water.
3. A normally closed and locked maintenance bypass is provided at the mixing valve and is of minimal length to avoid dead-legs.
4. Each shower on the system and any other critical temperature control application is served with local or point of use thermostatic (or combination thermostatic and pressure balance) protection listed in accordance with ASSE 1016 for the respective application and fixture flow rate. To ensure proper operation, the specific type of such devices shall have been selected in consideration of any potential imbalance of hot and cold water supply pressures, such as associated with upstream control valves and equipment.
5. Influent water quality is fully compliant with manufacturer requirements with regard to maximum hardness or other constraints.

Where these conditions are not met or for any condition where master electronic mixing valves are used, redundant (in parallel) thermostatic mixing valves are

required, sized in consideration of facility peak and minimum flows. The use of redundant devices, in parallel, and capable of ensuring thermostatic protection including under low-flow conditions is recommended.

**F. BAS Monitoring:** A temperature transducer shall be provided to alert BAS of hot water outlet temperatures (locate after the water heater and master mixing valve where provided), and at the main hot water return (or from each hot water return zone where multiple zones or multiple temperature returns are provided). The alert set points shall be set within 2.7°C (5°F) of the design operating set point for each function at the point of measurement or as required to accommodate normal variations in thermostatic controls.

**G. Fail Save Over-temp Protection:** Fail-safe over-temperature protection shall be provided downstream of master mixing valve stations that serve non-thermostatic type shower faucets whenever water is produced at temperatures above 63°C (145°F) or whenever providing hot water supply to non-ambulatory patient areas. The over-temperature device shall consist of a temperature transducer, solenoid valve, and alarm signal to BAS. The over-temperature protection device shall be arranged to individually isolate each mixing valve assembly and alarm an over-temperature condition. A minimum of two thermostatic, high–low systems shall be provided, each with its own over-temperature protection, and each capable of maintaining a minimum of 80% of the design peak flow at the design pressure drop to ensure continued supply of hot water in the event an over-temperature condition activates shutdown of a single mixing valve assembly. The piping design at the outlet of each mixing-valve station, inclusive of each individual temperature sensor and check valve shall be arranged to prevent actuation of both valves in the event of failure of only one device. The use of fail-safe over-temperature protection is not required for dedicated industrial/process applications, such as specialized equipment, laundries, or other applications not prone to inducing injury.

**H. Distribution System Heat Loss Recovery Heaters:** Where separate booster heaters are utilized for system heat-loss recovery (system temperature maintenance), the A/E shall ensure adequate controls and fail-safe over-temperature protection is provided to preclude risk of scalding. Systems utilizing supplemental energy sources (such as temperature maintenance systems and booster heaters) shall be provided only through means

that preserve adequate thermostatic protection and do not induce scald hazards. It is preferable to introduce a purge than to stop circulation for any prolonged period. Examples include where a closed recirculating sub-loop is created by use of a backflow preventer for a lab water system where a common water heater arrangement provides the supply for both lab and domestic (potable) hot water and a booster heater is therefore required to recover the heat loss in the sub-loop. Residential water heaters and instant-hot type units are not acceptable. Redundancy of booster heaters is not required.

---

### 8.3.11 Additional Requirements for Animal Research Facilities

**A. Shared Lab and ARF Systems:** ARF holding rooms, cage wash, and similar areas may be supplied from common laboratory water systems serving areas of equivalent biosafety level, except that extension directly from the potable water system shall be provided to all areas and functions for which potable water is specifically required.

**B. Potable Water Required Within General ARF:** Water supplies to animal food preparation areas, makeup to animal drinking water systems, surgical scrub, surgical sterilization (including autoclaves for surgical areas), transgenic/barrier facility sterilizers, aquatic system water supply makeup, and aquatic instrument, rack, and tank washing, as well as other areas where the water supply may be directly ingested or in contact with animals shall be made up directly from the potable water system (with point of use backflow protection as required by code). Locally isolated potable water supply may be used where specific to the function and labeled to minimize risk of cross-connections; however, provision of isolated water does not waive requirements for application of point of use backflow protection in full conformance with plumbing code as applicable to potable water systems.

**C. Potable Water Required Within Barrier Facilities:** Water supply to autoclaves, and other functions serving barrier facilities (specific-pathogen free, gnotobiotic, etc.), shall be from the potable system, with code required local backflow protection.

**D. Softening/Scale Control:** Water supplies for cage wash, tunnel wash, sterilizers, and similar equipment may require softening for control of scale. Review manufacturer's equipment requirements and refer to [Section 8.3.12 Corrosion Protection, Water Treatment, and Control of Scale](#).

**E. Cage Wash Area Water Heating and Metering:** Dedicated water heaters arranged to provide N + 1 redundancy are required for central cage wash areas. Metering of water may be required for large facilities and shall be determined by ORF on a project specific basis.

**F. Hose Stations:** Appropriate backflow protection is required for hose stations utilizing detergent or steam (up to ASSE 1013 type). Refer to [Section 8.3.6 Backflow Protection](#). Independent high pressure (typically 689–827 kPa [100–120 psig]) supplies may be provided if requested by the program and may incorporate hot water heating or central or local mixing stations where justified. At the NIH, hose stations are typically provided with lab/cage wash area hot and cold water. The facility cleanup operations and simultaneous use requirements shall be verified.

**G. Jetted Drains/Trough Flush Piping:** Jetted drains shall provide required flow, but at least 95–115 lpm (2–30 gpm) each. A minimum of 10 water supply fixture units is required per jetted drain on flushometer curves. The minimum size water supply to a flushometer or control valve serving a jetted trap is 32 mm (1.25 in.). The quantity of trough flush lines in simultaneous use shall be verified and flow rates calculated. The minimum allowance shall be a single room with all troughs in the room flushing plus the jetted drain and hose station in operation. Simultaneous use during cleaning of both jetted drains and trough rinse is typical. The minimum size cold water to a room with both jetted drains and flushing troughs shall be 40 mm (1.5 in.) diameter. Minimum size piping into a room serving troughs only, with no jetted drains is 25 mm (1 in.). Water hammer arrestors are required for all flushometers, hose stations, and trough rinse arrangements.

**H. Avoid ARF Sensitive Areas:** Refer to [Section 8.1 Plumbing General Requirements](#) for issues related to routing of piping systems and equipment.

## 8.3.12 Corrosion Protection, Water Treatment, and Control of Scale

**A. Water Treatment:** The application of water treatment shall be based upon site-specific water analysis. Refer to [Section 8.3.13 Available Water Supply/Water Supply Analysis](#).

**B. Required Applications:** Provisions to control scale shall be provided wherever the on-site water analysis demonstrates water supply conditions may be detrimental to long-term operation or impose excessive maintenance. The A/E shall review requirements for major lab and ARF equipment, heat exchangers, and liquid ring vacuum pumps and ensure conformance.

**C. Whole Building Water Treatment:** At the NIH campus in Bethesda, MD, the use of central, whole building water softeners, corrosion inhibitors, or chemical adjustment of incoming water supplies is not typically required or desirable. Softeners are typically required for cage washers and major (central processing) equipment. Determination of need of water softening, scale control, or corrosion mitigation shall be made after analysis of feed water supply, and in concert with equipment selections. Refer to [Section 12.1 High Purity Water Systems](#) for applicable water softener requirements. Assessments shall be made in conformance with EN12502 “Protection of Metallic Materials Against Corrosion, Guidelines on the Assessment of Corrosion Likelihood in Water Distribution and Storage Systems”; NACE, and the recommendations of the piping material association.

**D. Softened Water Piping Protection:** Water shall not be completely softened unless specifically required for the application (e.g., RO system feed, boiler makeup, etc.). Where softening is applied for general plumbing applications, automatic blending (typically with a pilot type hydraulically operated diaphragm automatic control valve) to achieve approximately 50 mg/L hardness as CaCO<sub>3</sub> (3 grains per gallon) shall be provide utilizing engineered automatic or calibrated flow control valves at the water softener outlet and commissioning for proper operation.

**E. System Flushing:** The A/E shall specify that systems be routinely flushed and protected from extended periods of stagnation, beginning as soon as systems are filled for initial testing. Where this is not practical,

systems shall be fully drained and dried. Flushing at not less than every third day intervals is required and shall be sufficient to achieve full water turnover.

*Rationale: Each system must be flushed, especially in the early stages of system startup to ensure development of appropriate corrosion inhibiting layers, to control microbially influenced corrosion, and preclude biofilms.*

**F. Scale Control:** Scale control may be achieved through one of the following methods:

1. Demand-based, automatic alternating ion exchange water softeners for regeneration. Point of use softeners, including service-exchange softeners requiring off-site regeneration at intervals of at least 35 days may be utilized for point of use limited demands where automatic regeneration is not deemed more appropriate. Refer to [Section 12.1 High Purity Water Systems](#) for water softener requirements. If subject to hot water, softeners shall be especially constructed for use at temperatures in no case less than 65°C (150°F).
2. Nanofiltration water softener designs, as approved on a project-specific basis, and engineered to ensure water supply potability.
3. Where fully compatible with water supply conditions based on a properly conducted on-site feed water analysis; the use of an approved epitaxial crystallization system may be accepted for local, non-critical, point of use applications. Such units shall not be installed on any copper piping system until at least 30 to 45 days usage has occurred prior to installation of the device. Such units are not acceptable substitutes where ion exchange water softening is required.

*Rationale: This provision provides an additional option that may be used in jurisdictions where the use of conventional water softeners (even with the use of potassium chloride) might not be permitted or feasible. Epitaxial crystallization devices are not installed on copper tubing prior to formation of the protective oxide layer to protect from premature corrosion failures.*



### 8.3.13 Available Water Supply/ Water Supply Analysis

**A. Pressure:** The available water supply shall be analyzed on the basis of flow test data resulting from a proper hydrant flow test performed by the DFM (off campus in accordance with requirements of the AHJ) on the closest effective hydrant, in accordance with NFPA 291, during the design phase. All systems shall be designed at a minimum of 10% below the water flow curve, but at least a 35 kPa (5 psi) allowance for future demands on the supply main and to account for flow test representative accuracy related to future conditions. Systems supplying fire protection shall additionally be in compliance with [Section 9.2](#).

1. The A/E shall evaluate water supply source conditions at the time of the flow test and make the appropriate adjustment(s) in calculations as required to account for seasonal system capacity fluctuations. The adjustment for low hydraulic gradient (water level range of allowance in the supply tank relative to piping and time of the flow test) or lowest operating pressure point shall be made prior to designing supply systems at a minimum 10% below the available supply curve. Hydraulic gradient information is typically available from DFM or may be calculated or obtained from serving water purveyors.
2. At the NIH campus in Bethesda, the A/E may obtain flow test data and low hydraulic gradient information by coordinating through the PO with the DFM. At other locations, coordination with the serving water utility may be required.

**B. Water Quality Analysis:** The A/E shall provide an on-site water supply quality analysis and submit the test results no later than 35% design document phase. The analysis shall indicate key water quality parameters specific to the building site and application to determine the extent of any required water treatment. Water samples shall be analyzed within 24 hours of sampling. The investigation of available water supply quality shall include appropriate diligence to determine seasonal and source variations in water supply and extent of contaminants that may be of concern or necessary for the proper design of piping systems and selection of materials. The A/E shall design systems in full compliance

with the *DRM* and compatible with the on-site water quality even if a water quality analysis is not required.

1. The testing shall be carried out by an accredited water quality lab operating within the scope of their accreditation. Sample collection shall be carried out either by the lab or under their direction by experienced personnel following appropriate protocols (ASTM, EPA, ISO etc.). Testing laboratories shall at a minimum be accredited in accordance with ISO 17025 by a signatory to the International Laboratory Accreditation Cooperation (ILAC) mutual recognition agreement. At least two on-site (or in the case of new construction, near-site) representative samples shall be taken, and should consider the worst case source water condition (e.g., generally the surface water supply).
2. In the case of conventional plumbing design, water test data need only be performed to the extent necessary to ensure satisfactory materials selection. Water analysis is required for all aquatics and water treatment system applications.

*Rationale: Source-water conditions can fluctuate. On-site sampling versus review of general/municipal annual reports is required for accurate and reliable representative data. The source quality and the associated sampling locations are not necessarily representative of the quality present at point of demand, and may not include required parameters. Required test parameters will vary with source and supply type and other site variables.*

### 8.3.14 Research Equipment Water

**A. Process-Cooling Water:** Research equipment such as lasers, NMR equipment, mass spectrometers, etc., often require a water source for cooling. Where possible, such equipment shall be connected to the process-cooling water system and recirculated for reuse. Application of suitable point of use filters may be required, inclusive of

pressure gauges and redundancy (in parallel). Plumbing water systems shall only be used as a backup for process cooled water. Refer to [Chapter 6: Mechanical Design](#).

**B. Backup Supply:** If water systems are utilized as a backup supply to any system, ASSE 1013 backflow protection is required unless proper heat exchangers are used per code.

**C. Filtration:** A point of use water filter of appropriate efficiency and capacity shall be provided to meet equipment water quality requirements. The plumbing backup water connection shall be provided with its own dedicated filter or shall be connected upstream of filtration serving the equipment.

***Rationale:** Connection to HVAC chilled water/process cooling-water systems is utilized for water/energy conservation and corrosion control. Filtration is typically required to protect research equipment.*

### 8.3.15 Equipment and Material

**A. Valves:** Shut-off valves for water systems shall utilize stainless steel trim. Ball valves shall be used for sizes 50 mm (2 in.) and smaller, and sizes 62 mm (2.5 in.) and larger shall be of three-piece construction. Ball valves shall be full port, and extended stems shall be provided to clear insulation. Main system/large diameter valves (100 mm [4 in.] and larger) shall be AWWA gate, AWWA butterfly, or high performance type, with stainless steel disk and trim. All valves shall be suitable for bidirectional flow, as well as for the system test pressure and temperature. Valves (inclusive of selected elastomers) shall be suitable for potable water application. Valves and components for hot water systems shall be suitable for potable operation at temperatures of at least 80°C (176°F). Valves and trim for otherwise entirely stainless steel systems shall be constructed of 316L stainless steel to facilitate non-chlorine disinfection.

**B. Suitability for Potable Water Use:** All components shall comply with NSF-61 provisions.

**C. Equipment Requirements:** Water heaters, mixing valves, pressure-reducing valves, backflow preventers, meters, booster pumps, filters, elastomers, and tanks shall be in accordance with the requirements of this section. Piping material and insulation shall be in accordance with the requirements of [Exhibit 6.3](#) and [Exhibit 6.4](#).

### 8.3.16 Quality Control, Startup, and Verification

**A. Installation, Testing, and Verification:** Systems shall be tested in accordance with code and verified to be installed in accordance with the contract documents prior to concealment.

**B. Pressure Testing:** Systems shall be hydrostatically pressure tested with potable water to at least 150% maximum working pressure, but at least 1,034 kPa (150 psig), for 4 hours. For freeze conditions, a 414 kPa (60 psig) air test may be applied to metal systems with no incompatible plastic components.

**C. Flush, Disinfect, Adjust, and Commission: Quality-Tested:** Prior to use, the entire system (both lab and domestic, hot and cold) shall be thoroughly flushed, adjusted, commissioned, and disinfected with approved materials compatible with piping system materials, and delivered water quality tested by qualified labs. The A/E shall specify the flushing of outlets is required to occur at each point of use to clear all contaminants, and shall be performed thoroughly prior to any disinfection. Upon completion of flushing and testing, the system shall be maintained in operational status with residual disinfectant and periodic flushing at not to exceed 3-day intervals, or drained and dried (and then disinfected and put into use when ready). For any clinical facility, daily water exchange is required.

***Rationale:** This is to control biofilm and piping system corrosion.*

**D. Inspection/Commissioning:** The inspection and commissioning process shall confirm required backflow control provisions have been met, all cross-connection control devices have been tested, verified and recorded



per the requirements of this section. Inspection shall confirm systems have been installed to serve their respective areas, proper flows, pressures, temperatures, and pressure balance, code, and contract documents.

**E. Chemical Disinfection:** Chemical disinfection procedures shall be specified to occur only after notification and approval of the PO. Chemicals to be used shall be verified compatible with all system materials. Chlorine use in disinfection of stainless steel systems shall be limited to 50 ppm for 24 hours. Peracetic acid/hydrogen peroxide is preferred for stainless systems but is not acceptable for systems containing any copper or brass components.

1. The disinfection and sampling process shall be performed in a controlled manner by qualified contractors with appropriate safeguards to protect facility and occupants from hazards.
2. Chemicals shall be utilized at required concentrations throughout the system, but for the minimal time required to achieve effective results, and shall then be immediately flushed from the system within the same day upon achieving required contact duration. Chemicals shall be listed for use in potable water systems and shall be compatible with system materials.
3. The A/E shall specify the disinfection process to be fully supervised for the entire duration. Do not rely on disinfectant residual levels to determine need for re-application of disinfection. Repeated procedures shall be based on test results so as not to damage piping.
4. Prior to sampling and as soon as possible after achieving required contact time, the disinfectant shall be thoroughly flushed from the system with potable water flowing at each outlet to achieve background water supply disinfectant residual levels throughout.

**F. Verification:** All components, controls, devices, and alarms shall be calibrated and individually verified for proper operation and adjustment, including but not limited to flow, pressure, temperature, time to get hot water from outlets at each building location and system type under no-load conditions, pressure balance of hot and cold systems, clean water discharge from outlets, and appropriate hardness. Systems shall

be fully commissioned including all critical parameters, proper response to power-loss scenarios, failure conditions, monitoring and alerts, including integrated systems testing. Verification of adequate flow, temperature, and pressures and proper adjustment of all fixtures and equipment shall be conducted.

**G. Water Testing:** The A/E shall specify an initial water quality test to occur as part of the facility commissioning or acceptance phases, and submit results to the PO prior to system use. Microbiological testing (heterotrophic plate count *E. coli* and coliform) is required of all potable and lab water systems, by a qualified lab accredited in accordance with ISO 17025 by a signatory to the International Laboratory Accreditation Cooperation (ILAC) mutual recognition agreement for the application and type of testing to be performed. Testing shall be conducted at least three different locations throughout each distribution system (Hot/Cold/Domestic/Lab etc.), and with greater quantities as required to adequately represent system water quality (at least two outlets per floor for multistory facilities), until successfully passed at each location. Tests shall demonstrate conformance with requirements of the SDWA. Lead and copper levels shall also be tested at each representative sampling location. Residual disinfectant levels shall be tested at remote points in the system.

**H. Additional Testing:** Where systems are provided with on-site water treatment (chemical injection or other methods of microbial control) additional tests are required based on the type of additive, effects, and byproducts and will be reviewed on a per-project basis.

*Rationale: Testing is to ensure a clean, uncontaminated water supply. Even where serving water supplies are compatible, inappropriate construction practices can result in piping systems contamination. Testing of basic parameters such as microbial to ensure water safety, as well as, copper levels and lead levels protects safety and provides assurances of system integrity.*

# Section 8.4

## Drainage Systems

---

### Contents

- 8.4.0 Introduction
- 8.4.1 Systems Approach
- 8.4.2 Discharge Prohibitions
- 8.4.3 All Systems: General Requirements
- 8.4.4 Piping System Slope/Grade
- 8.4.5 Piping Size
- 8.4.6 Cleanouts: All Drainage Systems
- 8.4.7 Sanitary, Lab, ARF, and Grease Waste and Vent Systems: General Requirements
- 8.4.8 Potential High Temperature Waste
- 8.4.9 Gravity Drainage, Pumps and Ejectors, and Backflow of Waste
- 8.4.10 Indirect Waste, Direct Waste, and Equipment Connections
- 8.4.11 Trap Seal Maintenance
- 8.4.12 Deep Seal Traps
- 8.4.13 Laboratory and Corrosion-Resistant Waste Systems: Additional Requirements
- 8.4.14 Animal Research Facility Waste: Additional Requirements
- 8.4.15 pH Monitoring and Neutralization: General Requirements
  - 8.4.15.1 System Location and Planning
  - 8.4.15.2 Equipment Requirements
  - 8.4.15.3 pH Treatment System: Equipment Sizing and Design Requirements
- 8.4.16 Alternatives to Automatic Central Building pH Treatment
- 8.4.17 Grease Waste and Fats, Oil, and Grease Control: Additional Requirements
- 8.4.18 Non-Emulsified Oil-Based Waste
- 8.4.19 Condensate Drainage
- 8.4.20 Storm, Clear Water Waste and Specialty Systems: Additional Requirements
  - 8.4.20.1 Primary Storm and Secondary Overflow Storm Drain-System-Sizing Criteria
  - 8.4.20.2 Primary Storm and Secondary Overflow Storm Drain: Additional Requirements
  - 8.4.20.3 Area Drainage
  - 8.4.20.4 Clear Water Waste Connections
  - 8.4.20.5 Underslab/Subsoil and Foundation Drains
  - 8.4.20.6 Gravity Drainage (Storm) and Backflow of Waste
  - 8.4.20.7 Parking Garage Drainage
- 8.4.21 Sump, Sewage, and Lab Waste Pumps
- 8.4.22 Quality Assurance, Startup, and Verification

## 8.4.0 Introduction

This section addresses sanitary, lab, grease waste, storm drainage, clear water waste, animal research facility (ARF) drainage, subsoil foundation/underslab, primary treatment equipment, and other types of drainage, waste, and accompanying vent (DWV) systems.

### 8.4.1 Systems Approach

**A. Sanitary Waste System Application:** A sanitary DWV system shall be provided to serve conventional sanitary plumbing fixtures, any piped to waste bedding disposal, and contaminated condensate wastes.

**B. Lab Waste/Vent System Application:** An independent, corrosion-resistant waste and vent system (typically referred to as “lab waste”) shall be provided to serve laboratory research areas, aggressive waste discharges, cage wash areas, and associated floor drainage and equipment). ARF areas generally require corrosion-resistant waste systems. Lab waste systems shall meet intent of code as applied to sanitary DWV systems unless otherwise noted.

**C. Grease Waste System Application:** A segregated grease waste system is required for commercial food service areas to address grease waste discharges (including floor drains) from such spaces.

**D. Waste Streams Segregation:**

1. Waste streams shall not be combined until after treatment devices, ideally at sewer manholes/ exterior laterals, or through connections to main waste lines e.g., building drains and building sewers.
2. Waste streams from any major batch treatment process shall discharge directly to the serving manhole or suitable mains (e.g., building drain or building sewer).
3. Waste discharges from major equipment and major program area classifications (e.g., animal holding, laboratory, medical, general sanitary, tunnel washers/cage washers, food service, etc.) and other waste streams with high suds or heavy grease content shall discharge directly to associated waste stacks or mains, and where possible

shall be segregated and not discharge through fixture branches serving other program areas.

***Rationale:** Systems are segregated based on their unique requirements attributable to each system type, to minimize potential of stoppages and flooding of systems into areas of unrelated function, and to minimize disruptions.*

**E. Dedicated Storm Drainage Systems:** A dedicated storm drainage system conveys roof and exterior area rainwater to the campus storm drain collection system. Underslab subsoil/foundation drainage discharges to this system. Except where adequate scuppers are provided, an independent secondary overflow drainage system shall carry rainwater to grade in the event of blockage or failure of the primary storm system.

**Table 8.4.1 Waste Discharge Classifications/Required System Connection** shall be used to determine to which system various equipment is connected. All projects not on Federal property shall comply with the requirements of the local AHJ and shall meet the requirements of this table unless not compliant with local requirements, in which case it must be approved, safe, and not in violation of federal discharge regulations.

### 8.4.2 Discharge Prohibitions

**A. Discharge Compliance:** Effluent provided as piped services from NIH facilities shall comply with the DRM and plumbing code requirements, including requirements of [Section 1.11 Environmental Management and Radiation Safety](#), the associated Environmental Protection Agency’s National Pollutant Discharge Elimination System and Federal Clean Water Act requirements, and conformance with Federal regulations 40 CFR Part 403 and 40 CFR Subchapter N prior to discharge into the on-site sewage collection systems.

**B. Campus Sewer Purveyor:** At the NIH campus in Bethesda, Maryland, the private campus sanitary sewer system discharges to the Washington Suburban Sanitary Commission (WSSC) municipal sanitary sewer system. At the point of discharge from the campus, effluent shall also comply with the requirements of the WSSC Plumbing Code, Chapter 8 “Industrial and Special Waste.”

**Table 8.4.1 Waste Discharge Classifications/Required System Connection**

Type of Discharge	Storm Drain Discharge	Sanitary Drain Discharge	Lab Waste Discharge	Grease Waste
Air conditioners: Water cooled, non-contaminated	a	a		
Animal holding rooms		b	b	
Aquatic systems: Small and local		x	x	
Aquatic systems drain, backwash, and blow-down: Central and large		c		
Area well	x			
Autoclave/steam sterilizers		x	x	
Boiler blow-down		x		
Cage washer/tunnel washer – with or without neutralization			x	
Cage wash area floor drains, descaling and prewash area, floor sinks and equipment – except bedding disposal grinders or pulpers			x	
Cooling waters and blow-down waters – individual determination based on contamination	a	a		
Condensate drains: Air handling unit, cooling coil, refrigerated equipment – atmospherically generated, non-contaminated condensate only	a			
Condensate equipment area, adjacent floor drain, or nearby point for coil cleaning		x		
Condensate drains where coil cleaning wastes cannot be reliably separated, including fan coil units		x		
Cooling tower: If treated (typical)		x		
Cooling water: Non-contaminated, non-contact (verify)	x	x		
Dishwashers: Commercial type, food service areas, all food service sales areas		Final high temp rinse only		x
Dishwasher: Light commercial or residential type, break room type		x		
Domestic plumbing fixtures, lavatories/water closets/showers		x		
Drinking fountain		x		
Elevator pit drain, hydraulic fitted with oil-precluding (limiting) pump system. Note: only indirect waste arrangements permitted		x		
Elevator pit drain: Except hydraulically operated elevators. Note: only indirect waste arrangements permitted		x		
Exterior areas exposed to rainfall	x			
Fire system blow-down/test and drain	d	x		

Type of Discharge	Storm Drain Discharge	Sanitary Drain Discharge	Lab Waste Discharge	Grease Waste
Floor sinks/drain receptors in lab and animal research facility areas			x	
Floor drains/floor sinks in food service areas (except ice machines/Ice pans)				x
Food display case: Refrigerated		x		
Food waste disposers in break rooms and similar areas		x		
Food waste disposers in food service areas				e
Waste disposers/grinders in lab/aquatic areas		f		
Generator in fuel tank area		x, g		
Hand sink—connect to waste system serving area		x	x	
High purity water system discharge: Reverse osmosis		h	x	
High purity water system discharge: Deionized			x	
Humidifiers: Non-treated water, non-steam	x	x		
Humidifiers: Treated steam or water		x		
Ice machine drain: Commercial, and industrial		x	x	
General lab equipment			x	
Labware/lab glass washer			x	
Loading docks: Enclosed		x		
Mechanical room floor drains and floor sinks		x		
Overflow from ponds: Ornamental, utility; check for chemical treatment (if any contamination must route to sanitary). Ozone treated with no other chemicals may be permitted to the storm system with prior approval.	x	x		
Overflow from tanks and reservoirs: Industrial process, if treated			x	
Parking garage with top deck exposed to rainfall	x			
Parking garage, intermediate decks		i		
Potable (chlorinated) water waste		x		
Pot/warewashing sinks and dishwashers, prewash and wash compartments				x
Roof drainage	x			
Sanitize compartment of sinks and dishwashers		x		
Subsoil/underslab/foundation drainage	j			
Transformer vault		g		
Water softener backwash		x		

*Note: Each design shall include air gaps or air breaks as necessary to prevent cross-connection between the drainage collection system and the water-air system or fixtures and equipment. All storm systems shall be arranged to preclude any potential of backflow into the building. All waste discharges shall be in accordance with Sections 8.4.1 and 8.4.2.*

<sup>a</sup>Unless it is assured that water is uncontaminated atmospheric clear water waste, route to the sanitary system only.

<sup>b</sup>Wastes from animal holding rooms typically discharge as lab waste due to associated routine cleaning chemicals, through pH treatment systems designed for solids per the DRM. Where cleaning chemicals and normal operations will not result in discharge violations, connection of animal holding rooms waste systems to the sanitary system is acceptable for small facilities only where corrosion-resistant piping is utilized and such areas are routed independently to site sewer manhole to facilitate monitoring and also remediation, if eventually required. Cage wash areas and associated equipment shall discharge through facility lab waste neutralization. Autoclaves/steam sterilizers typically to sanitary. Special waste handling may be required for animals larger than non-human primates.

<sup>c</sup>Wastes from aquatic systems typically shall route to the sanitary systems due to high solids. The use of corrosion-resistant piping materials is recommended, and is required for saltwater applications. Special waste treatment may be required for some program applications, refer to the requirements for aquatic systems.

<sup>d</sup>Fire water tests spilled at grade may route to the storm water system only where properly neutralized per EPA requirements. Where fire system includes biocides or other water treatment, waste must be to sanitary.

<sup>e</sup>Grease interceptor to be exterior type, and to be sized for solids.

<sup>f</sup>Approved only on a project-specific basis—not for high containment. Waste materials to be corrosion resistant at least to mains.

<sup>g</sup>If area must have drainage, a proper oil interceptor is required. Indirect waste protection is required for transformer vaults to provide fail-safe protection from flooding or backup of water. Fuel oil tank areas to be properly diked.

<sup>h</sup>Drains from reverse osmosis preferably to the lab waste system, but may be routed to the sanitary system where lab waste is not reasonably available. For such cases, use approved plastic materials (ASTM D2665 PVC, PVDF, or polypropylene) for trap and fixture horizontal branch.

<sup>i</sup>Dry-pan drain arrangement through a garage oil/sand interceptor with submerged water trap seal.

<sup>j</sup>Dedicated line to catch basin or an appropriate backwater protection arrangement required to protect from backwater backflow of storm into subsoil drainage system lines. No storm drain system connections permitted into subsoil drain system.



**C. Pre-Discharge Waste Treatment and Prohibition of Dilution as a Waste Treatment:** Wastes that require any form of special treatment prior to discharge to public sewer systems shall be treated individually at each building, prior to release to the campus sewer collection systems. Dilution is generally not acceptable and may be considered only for limited physical characteristics (e.g., elevated solids or BOD associated with ARF) that will not result in violation of campus discharge permits, hazards, risks or maintenance issues to campus infrastructure and then only with justification and approval of ORF and DEP.

**D. Exterior Interceptors:** The public and private on-site sanitary sewer systems shall be protected against the potential discharge of grease and oil originating from food handling, parking garages, transformer vaults, and other built construction through the application of properly designed and sized exterior interceptors.

**E. Private Waste Treatment System Additional Requirements:** Any facility that discharges to a private waste treatment system (PWTS) shall be subject to additional requirements that will be addressed on a project-specific basis, and shall meet requirements of any additional AHJs. PWTS shall not be used where a public sanitary sewer can be utilized. ORF and DEP approval is required. The design of PWTS shall require full morphological soils profile examination by a qualified soils scientist or geotechnical engineer based upon sufficient quantity of on-site borings and test pits. Future loadings, expansion capabilities and failure mitigation/replacement areas shall be addressed. Bypasses are not permitted around treatment equipment. Fail-safety arrangements and redundancy configurations shall be provided to ensure reliability and continuity of service. Compliance with the International Private Sewage Disposal Code is required. Pressurized distribution is required and systems shall be designed for routine high-strength waste streams (including high BOD<sup>5</sup>, TSS, and fats/oils/grease).

**F. Storm Water System Discharge Requirements:** Only uncontaminated storm water, groundwater, and uncontaminated atmospheric condensate may be discharged to the storm water system. Prohibited discharge includes, but is not limited to waste water from interior floor drains, elevator pit drainage (whether or not fitted with oil-precluding pump controls), chemicals of any type, including chemicals associate with cleaning of air handlers and fan

coil units, emergency dike relief from bermed or diked areas from chemicals or fuels or any discharge that is not directly suitable for disposal to natural waterways without inducing damage or hazards.

1. Where surface water from impervious areas discharges to storm systems, appropriate treatment may be required (e.g., coalescing filter interceptors). Comply with requirements of Clean Water Act and NPDES Permit. Refer to [Section 1.11](#).

**G. Aggressive Waste Streams:** Drains receiving high purity water discharge (e.g., laboratory sinks adjacent to water polishers and pure water production equipment), and condensate from high-efficiency fuel burning appliances, high salinity wastes, and other potentially corrosive wastes (e.g., lab and cage wash area wastes) shall discharge to the lab waste system utilizing corrosion-resistant materials detailed in [Table 8.4.1](#). Where lab waste is unavailable for areas where high purity water or high salinity waters require discharge, discharge to the sanitary system may occur through approved corrosion-resistant materials with appropriate treatment, subject to NIH approval and conformance with discharge regulations.

---

### 8.4.3 All Systems: General Requirements

The A/E shall comply with the following requirements to avoid structural or piping system damage, stresses, or other failures.

#### A. Excavation, Backfill, and Support:

1. Systems shall be installed as fully open trench work.
2. Excavation, backfill, support, dewatering, corrosion protection, and compaction requirements shall be specified in conformance with on-site geotechnical reports and recommendations of the geotechnical engineer.
3. Proper analysis of soils for each underground installation is essential. Coordinate between disciplines to ensure conformance with requirements of [Section 8.1 Plumbing General Requirements](#).

4. Excavations shall not be within a 45 degree angle of repose of the bottom of footings or foundations serving buildings, supports, or retaining walls. The A/E shall consider the width of trenches in arranging piping networks and may need to advise the structural engineer to lower the bottom of certain footings.
5. The A/E shall specify quality control means to ensure appropriate excavation, compaction, backfill, and protection of underground piping installations. Special requirements of manufacturer and reference standards for materials shall be followed.

#### **B. Plumbing Fixtures and Drainage System Openings'**

**Locations:** Plumbing fixtures, including indirect waste receptors, floor drains, and any other opening within the building into drainage systems shall be located only in readily accessible, normally occupied facility areas where any drainage backup would not induce significant damage, safety, or sanitation risks and would be readily detected. Plumbing fixtures (including floor drains and indirect waste receptors) shall not be located under casework, in storerooms for food, laboratory or ARF equipment or supplies, or other spaces where there is a sensitive sanitation risk, or in any high security, data, or other sensitive areas.

***Rationale:** This is to maintain sanitation and ensure that a malfunction may be observed and corrected before facility damage or significant contamination, pest control, or safety issues occur.*

#### **C. Distribution:**

1. Comply with piping routing and configuration requirements as per [Section 8.1 Plumbing General Requirements](#).
2. Waste and vent stack and storm drain leader locations shall comply with [Section 8.1 Plumbing General Requirements](#).

The use of fixtures with waste discharge above the floor shall be provided where possible to avoid pipe routing over restricted spaces. Double containment is required where drainage or hazardous liquid piping must be located directly

over highly sensitive spaces or equipment. Refer to [Section 8.1 Plumbing General Requirements](#).

3. Waste stacks of at least 100 mm (4 in.) should be provided, with corresponding vent stacks of at least 75 mm (3 in.) to serve lab and ARF areas. Such stacks shall be located at permanent columns, except where stacked utility corridor distribution concepts are utilized. Frequency of stacks shall be project-driven, but generally should be available to minimize horizontal piping runs in ceilings of program areas to less than 23–33.5 m (75–100 ft.), except where interstitial spaces are provided to facilitate horizontal pipe routing for access to each area.
4. Underground piping mains shall be routed under corridors rather than under finished program areas when possible. This requirement is especially pertinent to non-storm drainage systems. Waste piping systems shall be designed and installed in a direct manner, with minimal horizontal offsets to aid in the efficient transport of waste. Piping shall be run in practical alignment with the facility layout to facilitate flexibility and access.

***Rationale:** Avoidance over animal areas and other critical spaces is to minimize potential for leakage, disruptions, stress, and noise during access, maintenance, and renovations and to maintain sanitary conditions. By locating piping mains under corridors, such piping may be accessed with minimal damage or disruption to program areas and sensitive finishes, and provides for central, accessible connections to serve future changes.*

**D. Materials:** Piping, materials, and joint methods shall comply with [Exhibit 6.3](#). Drains receiving waste from high salinity discharges shall be constructed of suitable chloride-resistant materials. For intermittent discharges, such materials shall be carried at least to the point of sufficient blending with other waste streams.

**E. Insulation:** Drains receiving wastes sufficiently cold to drop below the ambient dewpoint at the location of the piping installation shall be insulated, including drain bodies as required to prevent potential condensation. Refer to [Exhibit 6.4](#).

**F. Identification of Components:** The cover of all interceptors, manholes, and treatment devices shall be stamped or embossed to identify the interceptor type and system served.

**G. Protection of Storm Waste:** All floor drains, interior open sumps, or other arrangements that have drain openings less than 25 mm (1 in.) above the floor and within the building shall discharge only to the respective sanitary, lab waste, or grease waste system. No drain connection which could become plausibly contaminated or misused may discharge to the storm drainage system.

**H. Gas-tight:** All sumps, lift stations, treatment devices, and other components and equipment connected to the drainage system shall be gas-tight and water-tight, including cover assemblies, to at least a 3 m (10 ft.) water head or 34 kPa (5 psi) air. All sumps and treatment equipment shall be adequately vented to maintain atmospheric conditions and prevent air locking.

**I. Trap Design:** All traps shall be self-restoring water-based seal type only, self-scouring design with no mechanical moving parts, interior partitions, or reliance on elastomeric components for the gas-tight seal.

**J. Surge Zones:** Connections shall not be made into waste stacks within surge pressure zones as associated with stack offsets or other areas that may result in suds or waste backup or excessive pressure transients as to affect trap seals.

---

## 8.4.4 Piping System Slope/Grade

**A. Sanitary, Lab, Grease Waste, Indirect Waste, and ARF Waste Systems:** Sanitary, lab, grease waste, indirect waste, and ARF waste systems shall be designed to maintain a minimum velocity of 0.6 m/s (2 ft./s). Excessive joint deflection or horizontal slopes that exceed 4%, but are less than a 45° angle from the horizontal are not permitted. Horizontal waste piping in sanitary, grease waste, and ARF waste systems, and any systems carrying substantial solids shall be provided with sufficient slope to maintain at least 0.9 m/s (3 ft./s velocity) as much as reasonably possible to aid in transport of solids. Velocity requirements shall be met by use

of required pipe sizes at required slopes, not by reducing pipe sizes below *DRM* or code minimum requirements. The use of two 45° ells is often preferred to 90° horizontal directional changes for systems with high solids or grease.

**B. Minimum Slope:** A minimum slope of at least 2% shall be provided for horizontal drainage piping with an internal diameter of 150 mm (6 in.) and smaller. A minimum slope of at least 1% shall be provided for horizontal waste piping sizes 200–250 mm (8–10 in.). A minimum slope of at least 0.5% shall be provided for horizontal waste piping 300 mm (12 in.) and larger. Trap arms shall be sloped at 2% regardless of pipe size except that slope of up to 4% is acceptable where the trap arm-length limitation (distance from the trap arm to the vent) has been adjusted.

**C. Storm and Clear Water Drainage:** A minimum velocity of 2 ft./s (0.6 m/s) is required. Slope of less than 1% is unacceptable for piping 150 mm (6 in.) and smaller, except that infiltration portion of underslab/foundation drains may run at 0.5%.

---

## 8.4.5 Piping Size

**A. Overage:** Systems shall be sized in accordance with plumbing code requirements. 20% overage shall be provided for all horizontal mains and vertical waste and vent stacks, including for underground services and sewer laterals, sanitary, and storm sewers and major infrastructure equipment (e.g., sumps, basins, pumps, and exterior interceptors). Overage is not required for subsoil foundation (underslab) drains. Systems shall be arranged to ensure adequate load is connected to ensure sufficient flow depth for waste transport with the required slope and velocities.

**B. Minimum Pipe Diameters:** Pipe sizing shall comply with requirements of [Table 8.4.5 Minimum Waste Piping Diameters](#). Vent system sizing shall ensure appropriate air flow to preclude positive or negative pressure transients from impacting required trap seals, and shall not be based solely on DFU values.

**C. Minimum Horizontal Waste Piping Size:** The use of horizontal waste piping less than 50 mm (2 in.) shall be limited to trap arms serving lavatories, sinks, drinking fountains, and similar fixtures.

**Table 8.4.5 Minimum Waste Piping Diameters**

Pipe Type	Minimum Diameter
Vent pipe	32 mm (1¼ in.)
Buried waste and vent pipe	50 mm (2 in.)
Waste pipe penetrating a single floor (located downstream of trap arms)	50 mm (2 in.)
Waste and vent stacks through multiple floors	75 mm (3 in.)
Horizontal fixture branches	50 mm (2 in.)
Trap arms	40 mm (1½ in.)
Storm and overflow drains	75 mm (3 in.)

**D. Drain/Trap Size:** Drains and traps serving janitor service sinks shall not be less than 75 mm (3 in.) diameter, regardless of anticipated usage. Individual showers and tubs shall be provided with 50 mm (2 in.) diameter traps and waste, except where greater is required for special applications. Where a drain serves as a shower drain for multiple showers or as a combination shower and room floor drain, 75 mm (3 in.) minimum is required.

**E. Piping Serving Lab/ARF Equipment:** Waste mains and risers serving lab equipment (including but not limited to autoclaves, cage washers, tunnel washers, and other major equipment items with high drainage flow rates) shall be designed with consideration of the potential for simultaneous discharge, peak discharge rates, and discharge duration without causing surcharging of mains or stacks, flooding, backwater, suds backup or excess pressure transients at trap seals, and shall in no case exceed half-full flow for horizontal mains or 1/4 full for vertical stacks..

**F. Floor Drains/Floor Sink Outlet and Trap Size:** Floor drains and floor sinks shall be provided with drains and traps that are at least 75 mm (3 in.) diameter, except that 100 mm (4 in.) diameter outlets shall be provided for grease or oil wastes. Typically floor drains and floor sinks in mechanical rooms and major program areas (e.g., cage wash) have at least 100 mm (4 in.) diameter outlets, but in all cases shall be sized adequately for inflow rates.

*Rationale: Minimum piping diameters ensure flexibility for programmatic changes, minimize maintenance issues, and provide for broad acceptance of the range of similar fixture and equipment connections to ensure minor changes in program, fixture, or equipment requirements can be made with minimal costs or disruption.*

## 8.4.6 Cleanouts: All Drainage Systems

**A. General Requirements:** Cleanout provisions for all drainage systems shall be in accordance with the requirements below except as noted for high containment. The system shall be designed to minimize horizontal offsets, ensure appropriate and sizing, and with consideration of sufficient flushing flow etc. to minimize inducing conditions that may result in stoppages or that are difficult to access.

**B. Location, Disruption and Damage Minimization:** Avoid locating cleanouts above or within sensitive spaces, fixed sensitive or hazardous equipment areas, including but not limited to lab, food service, surgical, and ARF equipment and supply rooms, or other areas where sanitary requirements or risk associated with cleanout opening and subsequent waste clean-up issues would be hazardous. Avoid placing mainline cleanouts within animal holding rooms or other highly restricted areas, and avoid placing cleanouts above animal holding rooms to the extent reasonably possible. Cleanouts shall be placed such that opening of cleanouts to serve a stopped waste line occurs only in an area that is readily cleanable and not subject to additional damage, safety, or sanitation concern as a result. Cleanouts serving individual fixture branches may be located within the space served. Mainline cleanouts shall be located to be accessible for service with minimal disruption and ready access.

**C. Two-Way Cleanouts:** Two-way directional cleanouts shall be provided at the building exterior, arranged to provide effective cleaning of mains through a separate entry for rodding upstream or downstream of flow. Two-way cleanouts are not a substitute for required cleanouts at the upstream end of horizontal mains.

There shall be no offsets in the risers of single-entry-type two-way or cleanout fittings. Single entry two-way cleanouts may be used for shallow lines where there are no offsets in the cleanout riser and cable direction can be reasonably controlled. Where manufactured double entry cleanouts are not available, they may be field fabricated from combination wye and 1/8 bend fittings, with the downstream fitting positioned to permit upstream rodding (against flow) and the upstream fitting to permit downstream (with flow) rodding of the drain line.

**D. Arrangement:** The maximum distance between cleanouts, including the length of cleanout risers shall not exceed 30 m (100 ft.). Cleanouts shall be provided at the base of waste stacks, and to serve upstream ends of horizontal drains and fixture branches that are greater than 3 m (10 ft.) long. All grease waste fixtures and fixtures with a high solids load shall be provided with cleanouts. Cleanouts shall be located such that no more than a maximum aggregate horizontal change of direction of 135° occurs prior to use of a cleanout, beginning from the downstream portion. No more than one cleanout is required per 12 m (40 ft.) of piping, provided the total horizontal to horizontal directional change does not exceed 270° or a total directional change of 360°. Reliance on the removal of a fixture or equipment (including but not limited to water closets, urinals, and trap return bends) is not acceptable in lieu of providing cleanouts.

**E. Required All Floors:** Cleanouts are required in accordance with the *DRM* for all waste systems at all floors, whether above ground or underground.

**F. Size and Plug Type:** Wall cleanouts shall be specified with appropriate plugs. Tapping of plugs directly into the waste or vent stack is not permitted. Where floor cleanouts are provided, they shall not pose a trip hazard. Full size cleanouts are required for all waste lines up to 150 mm (6 in.) in diameter, and shall be at least 6 in. for larger sizes as required to ensure effective full-bore pipe line cleaning.

**G. Above Finished Floor:** Where possible, cleanouts shall be located at a point less than 1,220 mm (48 in.) above the finished floor from which the cleanout will be accessed.

**H. Storm Drainage Systems:** Cleanouts for storm drainage systems, including secondary or emergency overflow systems, shall meet requirements of this section as for other types of drainage systems. The roof or overflow drain itself shall be considered as a viable cleanout for accessible flat roofs provided cleanout or access point spacing does not exceed 30 m (100 ft.) or 135° aggregate directional change, and the roof area can be safely accessed with drain-cleaning equipment, without necessity of hoisting. Above ceiling cleanouts may be used where required.

*Rationale: These provisions are to protect from flooding, maintain access, sanitation and gas-tight systems without excessive penetrations.*

## 8.4.7 Sanitary, Lab, ARF, and Grease Waste and Vent Systems: General Requirements

**A. Vent Systems:** Vent systems serving plumbing systems shall be of the conventional through-the-roof type, consisting of dedicated waste and vent stacks, except that stack vents extended from drainage stacks may be provided for facilities of not more than two stories (generally two branch intervals as defined by code) in total height, in lieu of parallel vent stacks. Vent system sizing and arrangement shall be sufficient to ensure positive and negative pressure transients are not so significant at trap seal location as to affect required trap seals. The A/E shall not merely rely on plumbing code for sizing of systems.

**B. Alternative Vent/Pressure Transient Control Systems:** Mechanical vent devices, air-admittance valves, the use of engineered drainage systems designed to mechanically manipulate the free flow of air, attenuate air pressures, or to manipulate fluid velocities or channel flows (including systems that utilize aeration and deaeration devices), and vacuum-type drainage systems are not permitted.



***Rationale:** Such arrangements can affect flexibility, reliability, maintenance, and/or safety provisions that are of special concern with biomedical lab, healthcare, and corrosive waste systems.*

**C. Single Stack Drain and Vent Systems:** Single-stack combined drainage and vent systems versus a single drainage stack serves as a combined waste and vent stack for multiple stories are not acceptable. This shall not preclude the use of vertical wet vent arrangements for fixtures within the same story.

***Rationale:** Such arrangements limit flexibility and can be compromised by surge flows associated with specialty equipment.*

**D. Drain Location Prohibition:** No Drains are permitted in electrical rooms, high-voltage spaces, or other spaces where a waste backup could pose significant hazard to personnel or facility. Drains are not permitted within chemical containment diking or any area where prohibited, untreated waste could enter the serving drainage system. Where drains are required, indirect waste arrangements to a receptor located outside the sensitive space at an approved location is required.

**E. Cleanroom Spaces:** Avoid drains in ISO Class 8 or cleaner spaces unless specifically approved by the program. Where required, such drains should be indirect waste.

**F. Minimization of Potential for Stoppages/Backflow:** Systems shall be hydraulically designed to minimize potential for stoppages and backflow of wastes or suds and to ensure provisions for maintenance. Special attention shall be provided to the design of sanitary waste systems serving low-consumption water closets and systems transporting wastes (e.g., heavy solids) that increase potential for pipeline stoppages. Arrange fixture connections to provide sufficient trail flows and avoid placement of high solids discharge fixtures at the upstream ends of branches and mains.

**G. Independent Vents:** Vents for clear water, storm systems, and trap inlets of hard connected equipment, and for other systems on opposite sides of trap seals shall not be interconnected so as to create any form of cross-connection or bypasses. Vents for treatment equipment

shall consider the submerged arrangement, position, and operating sequence of the treatment equipment.

**H. Fitting Pattern Requirements:** Comply with fitting requirements as outlined in plumbing codes for sanitary drainage systems. In addition:

1. Long-radius fittings shall be specified for horizontal-to-horizontal and vertical-to-horizontal direction changes. Fitting patterns and arrangements for vent connections to trap arms shall be made in accordance with plumbing code for sanitary drainage systems. Double wyes shall not be used in the horizontal position for drainage.
2. Sanitary tee fittings shall not be installed on their side or on their back as a waste fitting, or to serve as a connection of a vent to a waste pipe because of the potential for blockage. Sanitary crosses shall be avoided in drainage systems. Specially manufactured double-fixture fittings shall be specified for back-to-back or side-by-side fixtures discharging to the same vertical waste. Where double fixture fittings are not available and the served fixtures are not jetted traps, water closets, cage/tunnel washers, or other equipment with high surge flows, the use of a sanitary cross in the vertical position with the barrel at least two pipe sizes larger than the connected fixture branches is acceptable.

**I. Special Vent Arrangements:** When utilizing horizontal wet vents, circuit vents, combination waste and vents, or other specialized venting methods to serve drain inlets, the arrangement shall be taken as a separate branch off of the main waste line or vertical waste stack and extended to serve the dedicated circuit or wet-vented fixture branch. The main itself shall not serve as the horizontal wet vent or as a required portion of the horizontal wet-vented system. Venting arrangements reliant on the waste stack, without an auxiliary vent stack or dedicated vent are not acceptable.

***Rationale:** This is to ensure future extensions and modifications to drainage systems do not require excessive disruption, redesign, and modification of drainage and vent systems to maintain code conformance, unrestricted use, and proper operation.*



1. All wet-vent arrangements, including circuit vents and any form of combination waste and vents shall serve only fixtures located within the same story.
2. Vents for laboratory sinks shall be compliant with code requirements, including the requirement for vent rise above the flood-level rim. Where vent rise above the flood level rim is not possible due to casework restrictions or lack of presence of an umbilical within required trap-arm-length limitation, the fixture shall be vented as an island sink vent per plumbing code.

The horizontal foot vent may be installed in the casework rather than below the floor, provided the lowest portion is at an elevation fully above the top of the horizontal waste (preferably at least 300 mm [12 in.] higher). The foot vent shall be sloped back to drain at least 2%, constructed with drainage pattern fittings, and rise at the nearest wall or chase to a point at least 150 mm (6 in.) above the highest fixture flood rim served prior to additional horizontal offsets. A cleanout shall be provided to serve the foot vent.

*Rationale: Island vent arrangements are preferred over combination waste arrangements. They maintain higher velocities to improve scouring characteristics.*

**J. General Vent System Additional Requirements:** Dry vents shall not offset horizontally less than 150 mm (6 in.) above the flood level rim of the highest fixture served. Vent lines shall connect to horizontal mains above the horizontal centerline, either vertically to the top of piping or at a 45° angle from vertical. The minimum size for any vent termination through the roof is 75 mm (3 in.).

## 8.4.8 Potential High Temperature Waste

**A. Discharge Temperature Limitations:** Discharge of essentially continuous waste streams at temperatures over 60°C (140°F) is prohibited. Discharge of waste into drainage systems above 65°C (150°F) is prohibited,

whether as part of normal or irregular conditions, including intermittent discharges. Appropriate waste water cooling arrangements shall be provided.

**B. Closed Loop Cooling:** Where practical, cooling provisions should utilize closed loop connections (from approved building cooling water sources) with heat exchangers or other approved means to conserve water. Where once-through water is necessary, the use of alternative cooling water streams to facilitate cooling should be considered.

**C. Heat Reclamation:** Dependent upon application and determined benefit, the use of heat reclamation should be considered.

**D. Special High Temperature Piping Materials:** Regardless of the provision of after-cooling arrangements, pipe materials for drainage systems receiving routine potentially high temperature waste above 60°C (140°F) shall be of materials and joint methods approved for high temperature waste systems. Such piping systems shall be designed to address expansion/contraction issues (even where equipment includes an on-board after-cooler arrangement). Comply as follows:

1. The high temperature waste line material shall be extended from the fixture, equipment, or indirect waste receptor at least to the point where adequate cooling can be achieved through mixing with sufficient flow from other fixtures in the event of after-cooler failure, or to a point where sufficient heat dissipation occurs such that calculated temperature during after-cooler (or blend valve) failure conditions would be below 60°C (140°F).
2. The use of high temperature materials may be waived by NIH where the equipment utilizes a heat exchanger with process cooled water, chilled water, or chilled water return to ensure positive cooling, provided such units are either configured as N + 1 redundant or include another means to ensure waste water cooling (e.g., a backup after-cooler, blend valve, etc.). The use of dual-blend valves, discharge of cooling water to drains, and other once-through water discharges does not waive the requirement for provision of high temperature waste-handling materials.

3. Non-routine discharges and minor intermittent (low flow) discharges from equipment or fluid streams that do not operate above 71°C (160°F), and discharges configured with a positive means of cooling (e.g., thermostatically controlled blending tanks or use of heat exchangers that also include a suitable backup or redundant configuration) may utilize conventional sanitary or lab waste material for the application.
4. High temperature waste line materials are not required for drainage systems serving floor drains or receptors for emergency relief valves, provided the prolonged discharge of a valve would not likely result in significant or catastrophic damage.
5. After-coolers utilizing an external plumbing water source shall be provided with required backflow protection in accordance with [Section 8.3 Water Systems](#). After-cooler arrangements that do not connect to any waste line, indirect waste, or fixture drain, but only spill with a proper fixed air gap do not require any additional backflow protection. Heat exchangers shall be of appropriate configuration (single wall/double wall) as required for safety or contamination protection, dependent upon application.

**E. High Temperature Drain Outlet Connection Methods:** Where serving high temperature or potentially high temperature discharge, a flanged mechanical joint adapter with a PTFE or PVDF type flange gasket connecting to a flanged stainless steel floor sink outlet is acceptable, the use of special high temperature mechanical couplings with stainless steel bands and Viton/FKM gaskets, as well as use of threaded connections with 316 or better heavy stainless steel nipples or PVDF nipples may be utilized. Alternative joint methods appropriate for the application (such as high temperature caulked joints) may also be accepted; however, the arrangement must be compatible for the differing thermal movement characteristics of materials at the joint, and be of a permanent, durable, leak-tight joint type without chemical sealants.

***Rationale:** Conventional hubless and gasketed drain connections with fixtures receiving high-temperature waste, especially when after-coolers*

*have failed, are prone to leaks due to thermal cycling, and compression gasket-type joints, including those between plastic piping and stainless steel or cast iron drain bodies. Failures may occur with properly operating after-cooler arrangements that are configured without blending sumps, whereas the blending occurs in the drain system or trap.*

## 8.4.9 Gravity Drainage, Pumps and Ejectors, and Backflow of Waste

**A. Building Drainage by Gravity:** Drainage systems including all connected lines shall be designed to flow by gravity wherever possible and the use of pumping systems shall be avoided to the extent possible while complying with *DRM* requirements for the facility design. Where pumped systems are required, equipment shall be of the duplex type, each capable of discharging 100% of the incoming peak flow in the event of a pump failure. Building areas that are sufficiently elevated above the sewer so as to not require discharge through a pumping system, shall be routed independently of pump systems and shall discharge by gravity. The unnecessary routing of piping from upper levels into basements or underground may not be used to justify routing of such upper level areas through pumps/lift stations.

***Rationale:** These requirements ensure the operation of drainage systems at all times, without reliance upon mechanical devices or availability of power, which can be critical in the event of a malfunction, power outage, or disaster.*

**B. Backwater Valve Application and Systems Segregation:** Backwater valves shall be provided for any drainage main that serves fixtures or equipment with a flood level rim that is less than 230 mm (9 in.) above the elevation of the exterior manhole cover serving the system, and also above the next upstream manhole in the site-sewer system. Drains serving fixtures with flood-level rim elevations higher than these reference points shall not be combined with lower level mains upstream

of the backwater valve (or pump system) unless such piping cannot be routed with required slope. Fixtures with flood level rims that are located below the crown level of the sewer shall be pumped.

**C. Manholes as Emergency Relief:** If unbolted or vented sanitary sewer manholes are used, coordinate with site utility designers to ensure manholes are not located near to any adjacent waterway or area where such emergency relief condition might pose an environmental hazard. Sewage backups must be properly collected and cleaned.

***Rationale:** These provisions are to protect the facility, and especially basement-level areas from backup of sewage, and to minimize potential that upon stoppage of a drain, upper-level waste will continue to discharge and flood a basement.*

**D. Backwater/Isolation Valves Location and Bypass:** Backwater valves shall be accessible. A corrosion resistant sewage system type full way isolation valve (plug or shear gate) shall be provided where the repair or service of the backwater valve would cause disruption or flooding.

**E. Backwater Valve Type:** Where possible, the use of backwater valves that are full-way, normally open type (or devices located at the manhole) are preferred over device configurations that can interfere with the free normal flow of waste or air. Backwater valves shall be automatic.

**F. Documentation/Signage:** Buildings served by backwater valves shall be clearly noted on plans and Operation & Maintenance (O&M) manuals, and an identification sign noting the presence, application, and specific location of each device shall be permanently affixed immediately adjacent to the interior main water shut-off valves serving the building. The backwater valve pit shall also be identified with appropriate tagging or signage.

***Rationale:** Full-way type valves that additionally do not have components in the flow path preclude disruption to flow and are less susceptible to damage from cable drain cleaning operations than other valve configurations. Indicating signage is necessary to warn maintenance and service*

*personnel of presence and location of valves to preclude damage to valves or piping systems during service activities.*

**G. Main Line vs. Individual Backwater Valves:** The use of individual backwater valves at fixtures is not permitted in lieu of mainline backwater valves; however, where backwater potential only affects a limited and isolated fixture branch serving just a few minor fixtures, an accessible backwater valve may be provided for that branch. Where multiple fixture branches occur or multiple fixtures are located at elevations that would require backwater valve protection per the requirements of this section, main line devices to serve the entire isolated section shall be provided.

***Rationale:** Individual fixture backwater valves severely restrict flow and can result in ongoing maintenance issues, often leading to removal of devices and susceptibility for sewage flooding.*

**H. No Pumping Prior to Treatment:** With the exception of corrosion-resistant lift stations designed for lab or ARF area waste, wastes requiring treatment prior to discharge to the sewer system shall not be routed to lift stations or ejectors prior to treatment. Fat, oil, and grease wastes shall not be routed to a pump or ejector system prior to passing through the appropriate exterior interceptor.

---

## 8.4.10 Indirect Waste, Direct Waste, and Equipment Connections

**A. Indirect Waste Connections:** Unless otherwise required in the *DRM*, items classified as equipment generally require indirect waste connections. Connections between unrelated systems (e.g., plumbing and HVAC) and differing piping systems generally require indirect connections either as an air gap or air break as appropriate to the hazard and cross-contamination risk. Lift pumps located in elevator pits and other conditions where an open sump or untrapped waste is provided shall discharge indirectly through a proper trapped and vented indirect waste receptor. Drains serving bottle fillers or

other items that may be sanitized for animal contact or contact with animal food, water, or medical applications shall be provided with indirect waste with an air gap.

**B. Direct Connections:** Direct connections shall be provided for all conventional plumbing fixtures, waste treatment systems, interceptors, and for any equipment or condition where a sealed or closed connection is required in the *DRM* or by manufacturer's requirements, except where indirect waste connections are required by the *DRM* or code. Items discharging heavy solids (e.g., disposers, grinders and waste water lift pumps and ejectors) shall be directly connected. Direct connections are not permitted from steam or compressed gas piping systems, relief valves, or other conditions that could pressurize the waste system or induce safety hazards to users, system or loss of trap seals. This does not preclude direct connection of pump discharges from sanitary and lab waste pumps and ejectors, blow-out drains, or jetted traps.

**C. Sealed Indirect Connections:** Where sealed connections are required but protection from backwater is also needed, a direct connection into the inlet of a properly vented trap shall be utilized along with provision of a floor drain located on the immediate branch downstream of the connection (within 1.5 m/5 ft.), within the same room as the equipment service, with no intervening fixture connections. The floor drain shall be fitted with an electric trap seal primer and the flood level rim shall be below the connection to be protected. This arrangement shall be considered as an air break for non-critical applications where an air-break would be acceptable from a cross-contamination risk. Drain traps shall be at least 75 mm (3 in.) diameter and include a cleanout on the tailpiece to serve the drain trap.

**D. Indirect Waste Termination:** Indirect waste (including but not limited to fire sprinkler drains) shall not terminate into other plumbing fixtures including janitor mop sinks, showers, or other fixtures not dedicated specifically for receipt of indirect waste. Discharge from animal drinking water flush systems into lab sinks or drains within the same holding room is allowed.

*Rationale: Discharge of indirect waste through mop sinks can result in flooding due to excessive debris in these lines or cleaning materials (e.g., mop/containers) placed in the fixture, blocking the drain.*

**E. Lab/ARF Scientific Equipment Indirect Waste:** Indirect waste from in-lab equipment may discharge to an adjacent lab sink provided such waste is for minor drainage flows only (e.g., polishers and some bench top equipment), or shall discharge to another suitable fixture drain that is located within the same lab as the equipment served. Waste tubing shall be secured and arranged to maintain the required air gap above the flood-level rim and shall be fixed at a point to prevent flooding or displacement. Labware washers shall be connected to the fixture (sink) drain tailpiece, unless provided with a proper floor sink or wall type waste outlet box.

**F. Indirect Waste Receptors Arrangement and Location:** Indirect waste receptor placement shall be located to minimize the length of required indirect waste piping. Indirect waste shall discharge directly to an indirect waste receptor that is directly connected to the drainage system, and shall not discharge into another indirect waste line or from one indirect receptor into another. Indirect waste shall not be channeled into a remotely located receptor.

**G. Individual Routing:** Each item shall be individually routed to the respective indirect waste receptors, and shall not be combined into common indirect waste pipe, except for non-potable or other non-sensitive equipment that is immediately adjacent to each other and within the same room.

**H. Types and Application of Indirect Waste Receptors:**

1. Indirect waste receptors that are located or exposed in finished spaces shall be sanitary floor sinks with adequate sump capacity, proper part-grate design to eliminate splashing, and a removable internal dome strainer or sediment bucket. Refer to [Section 8.2 Plumbing Fixtures and Equipment](#).
2. Stainless steel wall outlet boxes connected to standpipes of at least 50 mm diameter may be used for various in-lab equipment drainage and other areas where indirect waste for receiving low flows or an elevated (raised) discharge is required, provided the front outlet box opening is not located inside casework or otherwise concealed, and is not located in a high containment or ABSL-2 or higher space.

3. In-bench sinks or receptors may be utilized (e.g., small diameter round sinks). Automatic trap seal protection may be required.
4. Floor drains or floor drains with drain receptor funnels may be used to receive indirect waste for limited flow applications, e.g., from ice machines and condensate. Waste shall not flood past the top grate. Proper top and sump designs are required for the application.
5. Connection into the tailpiece of lab sinks, floor drains, floor sinks, and other fixtures unless otherwise prohibited by code is acceptable with compatible sizing and provided both the receiving fixture trap and discharge source are within the same room when served with a maximum 1524 mm (5 ft.) developed length of indirect waste piping. A lab sink drain may be upsized to 50 mm (2 in.) to receive indirect waste provided the waste from the adjacent equipment does not exceed 30 lpm (8 gpm) intermittent or 15 lpm (4 gpm) constant.
6. Funnel receptors that are not part of floor drains or floor sinks may be utilized in finished areas only where fitted with an internal dome strainer; the entire body is constructed of 316 stainless steel arranged to be readily cleanable, fully accessible (not within casework), and where use of floor sinks, funnel-floor drains, or wall boxes, or indirect waste to the drain tailpiece of another fixture cannot be utilized or would be prohibited. At least one-half of the finished top of floor sinks shall be fully exposed. All other indirect waste receptors shall be fully exposed.
7. The use of a stand-pipe arrangement may be used only where necessary to integrate with construction conditions or other project limitations, subject to justification and approval. Stainless steel is required for sanitation. Enameled cast iron is generally not acceptable for finished spaces due to enamel chipping and because exterior services are not typically enameled and readily cleanable. Cast iron is not an approved corrosion resistant lab waste material. Standpipes through the floor shall be avoided in finished locations.
8. Cast iron floor sinks and catch basins or large sump drains with removable sediment buckets may be used for mechanical rooms and similar unfinished spaces and shall be adequately sized for peak flow and to permit removal of sediment buckets/grates for cleaning. Stainless steel receptors or other approved corrosion-resistant materials shall be used for drains receiving waste from low conductivity high purity water systems or other low conductivity discharges.
9. Drains receiving waste from high salinity discharges (including but not limited to the reject from direct osmosis high salinity RO system cleaning and certain aquatics applications) shall be constructed of suitable chloride-resistant materials.
10. Hub drains and standpipe receptors at least 50 mm diameter are acceptable for use in mechanical rooms and similar unfinished areas, though are generally less desirable than floor sinks and similar receptors, unless above-floor drainage is required. Where an air gap is required, such drains must be dedicated funnel receptor-type drains, with an internal dome strainer or basket.
11. The minimum size of any drain or trap serving a floor drain or floor sink, regardless of application is 75 mm (3 in.).

***Rationale:** Adequate capacity in top dimension, sump, and discharge pipe is necessary to preclude flooding and stoppage, and to permit stoppages to be readily cleared.*

**I. Receptor Connections/Location:** Indirect waste receptors shall be directly connected to the serving drainage system with properly trapped and vented connections, and the receptor shall be located as close as practical (generally within the same room) as the fixture or equipment served to minimize the length of indirect waste piping. Although location of the receptor in a room other than where the fixture or equipment requiring the indirect waste is located is generally prohibited, it is acceptable to locate the indirect waste receptor within the manufacturer's utility service area for the equipment (e.g., autoclaves, cage washers, and tunnel washers), provided the drain is readily accessible and unconcealed. Indirect waste receptors shall be installed only in readily accessible, normally occupied spaces, and shall not be located in toilet rooms, crawl



spaces, casework, closets, storerooms, or any concealed location. Receptors serving equipment may be located in the walk-in or readily accessible utility access area for the equipment. The placement of drains serving cage-wash, sterilizers, and other pit mounted equipment shall be coordinated to ensure access. Floor sinks shall not be located under casework, but may be within the toe kick. No drain opening may be located where a backup or blockage would be undetected or cause damage, tripping, or a sanitation hazard. Indirect waste receptors shall not be located behind finished construction, whether or not provided with access.

***Rationale:** Placement of the receptor in the same area served is to minimize risk of flooding and ensure the fixture may be effectively monitored in the event of a stoppage, and to promote a sanitary installation.*

**J. Hub Drains and Standpipe Receptors:** Hub drains and standpipe receptors shall not be utilized in finished areas. It is acceptable to provide wall waste outlet boxes for laboratories and similar applications where the box opening is exposed into the room and unconcealed.

***Rationale:** Hub drain installations do not typically provide readily cleanable surfaces, and may pose safety hazards, leak paths and an open path for debris and trash to enter drain systems.*

**K. Floor Drain/Floor Sink Installation:** Floor drains and floor sinks shall be installed with their top grate flush with, or no more than 3 mm (0.12 in.) below, the finished floor. The floor or adjacent area can be sloped to receive the receptor as required. The top grate of floor drains and floor sinks shall not be elevated above the floor, except for special receptors intended to segregate clear water waste for the storm drainage system. Floor sinks shall not be located under casework. At least one-half of the top of floor sinks shall be visible, and grates shall be removable.

**L. Labware Washers, Ice Machines, Etc.:** Labware washers, ice machines, and similar, within labs shall discharge to an adjacent sink drain tailpiece where possible, or to an accessible unconcealed wall outlet box fitted with a trap primer, or to a funnel top drain that has been provided with a trap seal primer. Outside of lab areas, such items shall discharge to an approved

indirect waste receptor. Air gap fittings are not required unless used for a sanitary application (e.g., aquatics or animal food/water wares), provided the drain is looped high and fastened under the sink rim. Where a waste receptor is provided solely to serve equipment that may not remain in frequent use (e.g., undercounter type labware washer) a trap primer is required.

**M. Waste Disposers, Bedding Grinders, Etc.:** Waste and bedding disposers and similar equipment shall connect directly to the drainage system and shall not discharge through indirect waste receptors.

***Rationale:** Solid wastes, including ground-up matter and pulp, create unsanitary conditions and can result in drain-line blockages and overflows where indirectly connected, and can quickly flood indirect waste receptors.*

**N. Health Concern Areas, Coolers and Environmental Control Rooms:** Drains shall not be provided in walk-in coolers, environmental (cold/hot) rooms, human or animal food-storage areas, or other areas where a backup could cause a health concern or potential contamination. Where required, the preferred approach is to slope to a trench drain outside the space. Where this is not satisfactory, indirect waste with an air gap shall be utilized. For environmental rooms, cold rooms, and similar equipment, condensate drainage from such rooms shall be routed as indirect waste to a receptor properly located outside the equipment.

**O. Indirect Waste Pipe Size and Cleanouts:** Cleanouts are required for all indirect waste piping, including but not limited to condensate drains. Indirect waste piping shall be a minimum 20 mm (0.75 in.) diameter, unless such piping is less than 4.5 m (15 ft.) long. Cleanouts shall be provided at the upstream end of each line, at each aggregate change of direction exceeding 135 degrees starting from the downstream end, and at intervals not to exceed 15.25 m (50 ft.).

**P. Laboratory Vacuum Equipment Drainage:** Laboratory vacuum systems may be subject to ingestion of various contaminants.

1. Components that are protected by upstream main line vacuum filters per [Section 12.4 Laboratory Vacuum Systems](#) shall discharge



through an indirect waste using a conventional air break or air gap.

2. Waste discharges located upstream (house side) of main line filters (e.g., the liquid separator, knock-out pots, receiver arrangement that serves as a liquid separator); as well as all discharge connections for biomedical lab vacuum systems that do not utilize mainline filters, shall discharge to the drainage system through a sealed type indirect waste in accordance with this section. Provided service intervals will not be required more frequently than quarterly; wastes may be collected in a sealed, ASME code constructed corrosion resistant gas-tight vessel or liquid separator that is fitted with valved ports to permit introduction of decontaminant solution, a sight glass or other non-contact means of monitoring liquid level, and with normally closed valved and capped manual drainage provision. Vessel requirements larger than 38 L (10 gallons) shall require pre-approval of DOHS. A total of two vessels shall be provided, each with valving for isolation, independent decon, and service continuity. Where filters are provided downstream of liquid separators, they shall be arranged to drain back to the separator.
3. Sealed type indirect waste connections shall consist of hard connections from equipment to the tailpiece of a p-trap that is at least 75 mm (3 in.) diameter, with vent protection on each side of the trap seal, and a floor drain configuration arranged to protect from backwater/backflow. A corrosion resistant, metal gate, swing-type check valve shall be provided horizontally at the connection with equipment, including for connections that utilize a manual, normally closed valves (e.g., receivers and separators). A fresh air vent minimum of 50 mm (2 in.) diameter shall be provided on the inlet side of the trap (connected to the drain tailpiece), but downstream of any check valve and isolation valve arrangements used to seal the discharge (including overflow connections where provided). The vent shall not offset horizontally until above the system vacuum receiver (tank). The fresh air vent on the inlet side of the trap shall extend to a safe exterior location. Vents shall increase to at least 76 mm (3 in.) diameter prior to penetrating to the exterior.
  - a. An automatic trap primer shall discharge into the fresh air trap inlet vent to maintain the trap seal. The vacuum system equipment connection(s) shall be made into the branch(es) of a vertically arranged single (or double) sanitary tee or Y-branch fitting installed on the tailpiece (inlet side) of the trap, with the top of the fitting provided with a full-size removable plug to serve as a cleanout for the at least 75 mm (3 in.) diameter drainage trap. Where the tailpiece offsets horizontally to serve multiple equipment items, a cleanout shall be provided to serve the horizontal piping. The trap shall be deep seal type. The drain(s) from vacuum pump seal water purge and other vacuum equipment discharge sources that are normally in open position shall be direct connected to the drainage system tailpiece upstream of the fresh air vent and shall include an isolation valve at the equipment connection, before the fresh air vent. Multiple drains from the same vacuum system may connect to the same trap inlet.
  - b. Valving shall be provided on the discharge connection from each vacuum pump, receiver, separator and similar equipment to allow for controlled discharge to the drainage system, manual operation, and isolation as required.
  - c. A floor drain with a deep seal trap and automatic trap seal primer shall be located in the same room as the vacuum system with the flood level rim elevation of the floor drain on the same floor level or below the vacuum pump. The floor drain shall be located within 1.5 m (5 ft.) of the drain trap serving the vacuum equipment and shall be connected to the same waste line serving the vacuum equipment.

***Rationale:** This arrangement maintains a closed system, and limits exposure to the vacuum system or potentially contaminated waste stream prior to disposal through the sanitary system and venting, while essentially maintaining an air-break to protect equipment and protect traps from*

*vacuum. The floor drain configuration maintains an air-break by protecting the vacuum system from potential backflow in the event of a waste stoppage. The vacuum system is isolated from the plumbing system by being normally closed at the receiver/separator side of the pump. Isolation valves, vents, and check valves protect from impacting trap seals. Provision of an adequately sized fresh air vent maintains atmospheric pressure for free drainage flow and (where applicable for check valve sealing) also precludes interference with intended design of liquid seals used for traps or vacuum seal operations. Venting of the tailpiece maintains balanced pressure on each side of the trap seal and permits sealed receivers and separators to be properly drained.*

**Q. Drainage from Veterinary Surgical Vacuum Systems:** Veterinary medical vacuum systems may be subject to limited ingestion of liquids, which may include potential microbial hazards. The following drainage configuration is required:

1. Where the vacuum system is configured with appropriate in-line filtration at the vacuum source equipment (e.g., within the mechanical room), discharge shall be indirect to a floor sink or funnel type floor drain. Filters shall be provided upstream of the vacuum equipment in N + 1 (in parallel) configuration and each shall incorporate a sufficiently sized liquid separator with valved ports for isolation, manual decontamination and manual drainage. Each liquid separator shall be sized adequately to ensure service is not required at intervals more frequently than annually, and shall include a sight glass or other non-contact means of monitoring liquid accumulation. Refer to [Section 12.5 Veterinary Medical Gas Systems for Animal Research Facilities](#).
2. Where the use of filtration is waived the unit shall be arranged as per requirements for lab vacuum equipment above, and shall be arranged to facilitate decontamination for service.
3. Refer to [Section 12.4 Laboratory Vacuum Systems](#) and [Section 12.5 Veterinary Medical Gas Systems for Animal Research Facilities](#) for application of filters, filter type, biohazard protection, and additional details.

**Rationale:** *These requirements are to protect from failure, overflow, or omission of a suction bottle filter at the point of use. Open connections (indirect waste) is acceptable where the system includes filtration and is preferred for this application as there are no chemical vapors. Upstream collection of liquids (e.g., the liquid separator or vacuum receiver if so configured) is required to protect the filters from blockage.*

**R. Food Service Drainage:** Dishwashers for food service prep areas and equipment (except disposers) shall be connected as indirect waste with an air gap to a floor sink for commercial dishwashers and to an air gap fitting discharging to an adjacent sink drain tailpiece or disposer for residential type dishwashers. Food handling sink compartments and other culinary and warewash fixtures shall discharge individually through an air gap to a floor sink. (Prewash and wash may use an airbreak). Pre-scrap stations, including those with disposers shall be directly connected. Drains receiving waste from other food handling equipment, including ice machines, shall discharge through an air gap to a floor sink or floor drain with funnel top. Floor sinks and drains, including the drain body and top grate for food service and other finished areas shall be stainless steel. Refer to [Section 8.2 Plumbing Fixtures and Equipment](#).

## 8.4.11 Trap Seal Maintenance

**A. Trap Seal Loss:** Provide automatic trap seal primers to replenish trap seals wherever drains are subject to infrequent normal use or other loss, or where required by NIH.

**B. Trap Seal Primer Type/Configuration:** Only electric-type, time clock-actuated trap primers shall be utilized. A single, dedicated trap primer line shall be provided from the primer device to each trap served. In toilet rooms, trap seal primers may be operated from a water-closet flushometer that is of at least a 6 lpf (1.6 gpf) operation. Mechanical trap seal devices, trap avoidance devices, drain tailpiece water diversion devices, deep seal traps, mineral oil, pressure-actuated trap seal primers, and elastomeric drain opening seals are not acceptable.

***Rationale:** Reliable maintenance of trap seals is significant to pest control, avoiding impact to research, and biosafety. Electric time-clock actuated primers are reliable and limit the amount of water discharged through drains.*

**C. Floor Drains and Mechanical Room Drains and Receptors:** Floor drains in toilet rooms and mechanical rooms shall be provided with automatic trap seal maintenance. Trap seal primers are also required in ARF and lab areas where drains are subject to insufficient use.

**D. Constant Usage:** Floor sinks serving plumbing fixtures, equipment, or appliances utilized year-round at least on a biweekly basis do not require external trap seal maintenance; however, indirect waste receptors serving mechanical equipment shall be carefully evaluated to ensure adequate flow.

**E. Trap Seal Primers at Indirect Waste Receptors:** Automatic electric trap seal primers are required to serve the indirect waste receptors for local undercounter labware washers and ice machines in general labs, and other waste openings with reasonable potential of seal loss. Trap primers are not required for major autoclaves, cage wash equipment, undercounter washers or lab equipment discharging to sink drain tailpieces. Primers are not required where undercounter labware washers are connected to the inlet of a lab sink trap at the drain tailpiece. Primers are not required for a floor sink or indirect waste receptor that is provided for a normally used plumbing fixture.

**F. Trap Seal Primers for Animal Areas:** Where floor drains are provided in small animal (e.g., rodent) holding rooms, building corridors (including within the ARF or lab area), or other areas that may not see routine sufficient normal liquid discharge, automatic electric trap seal primers are required. Trap seal primers are not required for large animal holding room jetted drains, trough rinse drains, or floor drains serving spaces which will be routinely hose-washed.

**G. Trap Seal Primer Inlet Fitting:** The trap seal primer shall be connected to the tailpiece above the trap seal.

**H. Defective Trap Seal Identification Systems:** Such systems may be applied on a per-project basis, subject to use of compatible materials and arrangement to ensure system flexibility and conformance with the *DRM*.

Proposed use in research areas shall require preapproval of veterinary and research staff to ensure no impact to research.

## 8.4.12 Deep Seal Traps

The required depth of deep seal traps is specific to the application, but shall be a minimum 100 mm (4 in.) deep from crown weir to the top of the dip of the trap. Sewer drains shall not be located in pressurized air plenums. Deep seal traps are not an acceptable substitute for proper venting or the provision of trap seal primers.

***Rationale:** Deep seal traps should be utilized only for areas where it is required to provide additional protection against ambient pressure imbalances between the fixture inlet and atmospheric pressure.*

## 8.4.13 Laboratory and Corrosion-Resistant Waste Systems: Additional Requirements

**A. Description:** Corrosion-resistant laboratory waste systems are required to serve all drainage within laboratory areas unless noted in the *DRM*. Laboratory waste and other corrosion-resistant waste and vent systems shall be separate from the general sanitary waste and vent system and shall be provided in accordance with the requirements for waste systems of this section.

**B. Design Restriction:** Corrosive waste streams of highly acidic or highly caustic concentration that could result in unsafe exothermic reactions or otherwise be hazardous in the piping system shall be treated locally prior to disposal or collected for disposal as per NIH policy.

**C. Sizing and Throughput:** The A/E shall evaluate sizing of laboratory waste systems as many items of equipment and usage profiles do not directly correspond to flow rates and values of common Hunter's

Curve or plumbing code fixture unit tables (as the tables are based around flow-discharge characteristics of domestic plumbing fixtures and water closets). Cage washers, tunnel washers, autoclaves, and similar wash equipment can generate particularly high peak flows, and wash equipment often produces suds-laden and corrosive waste. Throughput, actual discharge rates, and simultaneous operation modes shall be considered for all equipment and shall not limit the use of the facility.

***Rationale:** Failure to adequately consider simultaneous surge loads can result in flooding, suds, and significant costs and disruption.*

**D. Floor Drains in Labs:** Floor drains shall not be provided in labs; however, floor sinks and funnel-type floor drains are permissible in BSL-2 areas as required to serve lab equipment. Floor drains may be provided in ABSL-2 areas as required. Floor drain applications in BSL-3/ABSL-3 are restricted; refer to [Section 8.6 BSL-3 and ABSL-3 Biocontainment](#).

***Rationale:** This is to minimize the potential for intentional or accidental release of prohibited discharges into the drainage system, especially as this could occur in the event of spills. Special requirements apply to high containment and maximum containment and are addressed in other sections. Floor drainage is typically required in ABSL-2 areas for sanitation (with the exception of small animal/rodent rooms).*

**E. Equipment Connections:** Indirect waste (air gap or air break as appropriate) shall be provided for lab equipment in accordance with requirements of this section. Refer to [8.4.10 Indirect Waste, Direct Waste, and Equipment Connections](#). Traps under lab sinks and fume hoods serving sinks and similar fixtures shall be removable for service. The transition from the mechanical joint to the non-mechanical or fusion joint shall occur within the trap seal or immediately downstream of the trap.

**F. pH Monitoring and Neutralization:** Lab waste systems shall serve all lab areas and shall discharge through a pH monitor and neutralization system in accordance with requirements of this section.

**G. Cleanouts:** Cleanouts for concealed lab waste systems shall be access housing type, with appropriate anchor flange where cast in floor, e.g., to facilitate use of only corrosion resistant and gas-tight materials and pipe closure methods. Type 316 stainless steel cleanout body units may also be used where appropriate. Wall cleanouts may be a stainless steel plug or piping system material, extended to within 80 mm (3 in.) of wall service with independent access housing/cover. An airtight/water-tight gasketed access door with appropriate rating for wall construction may be utilized as appropriate to the area. Gasketed/sealed arrangements are required in ARF areas.

## 8.4.14 Animal Research Facility Waste: Additional Requirements

**A. Compliance:** Waste systems serving ARF areas shall comply with requirements for lab waste systems and other requirements of this section.

**B. Waste Segregation:** Waste from ARF areas (including but not limited to cage wash areas and animal holding rooms) shall be segregated from other non-ARF building areas to the extent possible.

***Rationale:** Maintaining segregation of these areas is required to minimize risks and disruptions to ARF and other building spaces associated with waste backups and also to facilitate future pH adjustment. Discharge of waste from other building areas into the ARF can cause flooding within the ARF in the event of waste line/sewer stoppage and so it is preferred that waste from main building areas (especially upper building floor levels) bypass the ARF areas. In all cases, conformance with backwater requirements as indicated in this section is required to minimize risk of flooding.*

**C. High Solids, pH Compliant Waste:** Waste with high solids (e.g., from large animal holding rooms, jetted drains, and trough drains but not including major wash equipment) may discharge as sanitary waste (preferably directly to the sanitary sewer manhole), independent of



other building areas and may bypass the pH treatment system where wastes can be assuredly determined to be in conformance with discharge regulations, and subject to NIH approval.

1. Where conformance with discharge regulations may be compromised due to incidental waste streams or cleaning chemicals and practices per the program, waste must discharge as lab waste through the pH treatment system, which shall be designed for operation with such solids.
2. Waste from cage washers, tunnel washers, and cage wash areas shall discharge as lab waste through pH treatment systems, except bedding disposal units; regardless of provision of on-board neutralizers. Refer to [Section 8.4.15 pH Monitoring and Neutralization: General Requirements](#).

***Rationale:** Although it is ideal if high solids wastes are discharged directly to the building sewer manhole, the extensive use of cleaning chemicals and concentrated wastes may require pH adjustment.*

**D. Jetted Traps:** Drainage piping mains and fixture branches serving multiple large animal holding rooms (including non-human primates [NHPs]) shall be at least 150 mm (6 in.) diameter unless the drains are fitted with jetted traps (jetted drains), in which case 100 mm (4 in.) minimum is required. Adequate flow with a velocity of at least 0.61 m/s (2 ft/s) and a slope of at least 2% shall be provided. Omission of jetted traps is generally not recommended, but may be approved by NIH for limited applications if the design addresses solids, solid waste transport, and adequate waste water flow. Provision of strainers/baskets alone is not a substitute for jetted drains in NHP/large animal spaces.

**E. Waste Stoppage Protection, Sanitation, and Solid-Waste Transport:** Where bedding disposal units are provided, they shall be direct connected (hard piped) with a cleanout on the trap inlet, fitted with at least a 100 mm (4 in.) diameter trap, and the receiving main should receive waste from at least one steam sterilizer or similar fixture with a high-flushing flow rate. Minimum velocities of 0.91 m/s (3 ft/s) velocity shall be provided for piping carrying high solids waste and connections arranged to provide trail flows to ensure

solids transport. Systems shall be arranged to minimize horizontal to horizontal offsets. The use of two 45° ells is often preferred to 90° horizontal directional changes.

***Rationale:** Waste stream from animal areas are especially subject to stoppage due to high solids loads. Bedding disposal, washers, prerinse areas, and similar equipment may discharge excessive solids that must be accommodated without plugging the waste system.*

**F. Drains for Pit Mounted Equipment:** Drains for pit mounted equipment shall be accessible.

**G. Piping Routing:** Ideally lines should be routed in interstitial spaces, or at a minimum above or beneath corridors to facilitate access for repairs and renovation. The A/E should consider access restrictions and cross-contamination control protocols, and minimize noise and potential sources for leakage or maintenance issues.

**H. Drain Requirements:** The A/E shall review the need for drainage for animal holding rooms with ARF personnel. Sufficient drains shall be provided to facilitate cleaning and rapid water removal. Drains shall be provided in ARF corridors and other areas where hose-down or wet washing is required.

**I. Jetted Drain Fittings and Venting:** Jetted drains shall be individually vented and shall not be connected to back-to-back sanitary cross-type fittings.

***Rationale:** This requirement is to prevent waste blow-out from one fixture into another, and to allow for control of pressure transients. Jetted drains shall be treated as blow-out fixtures.*

**J. ARF Floor Drains:** Where floor drains are used in ARFs, conform to the following:

1. Sufficient means shall be provided for clearing waste stoppages without disrupting animals, including (where possible) placement of cleanouts outside animal holding rooms and to serve mains. Where cleanouts are necessary to serve piping within animal holding rooms, utilize two-way cleanouts located outside the room where practical and arranged to minimize waste stoppages and need to enter animal holding rooms or other sensitive areas.

- Where floor drains are provided in small animal areas, they shall be sealable (gas-tight) with blank secure gasketed covers and fitted with primers.

**K. Drains in Large Animal Spaces:** Floor drains in large animal spaces shall conform to the following additional requirements:

- For typical large animal holding rooms, sloping troughs shall be provided along the cage rack walls to serve cages, discharging to at least one jetted drain per room.
- The jetted drain may be located in a common end-wall trough (where side-wall troughs collect into a common trough), or separate drains may be provided for each individual trough.
- The arrangement of troughs shall be coordinated with rack placement and protective wall rail requirements.
- The use of basket strainers and sediment buckets in drains is not a substitute for jetted traps.
- Where solids will not be disposed through the building drainage system, troughs and jetted drains are not required (unless needed for program flexibility).

**L. Trench Drains:** Trench drains (i.e., trough drains with top grates) shall be avoided in large animal holding rooms due to cleaning issues, but may be required in some areas for floor drainage (e.g., cage wash rooms) to facilitate rapid drainage of water.

**M. Drain Pits and Catch Basins:** Drainage pit arrangements shall be impervious, readily cleanable, sloped to prevent any standing water, and arranged such that drains are unconcealed and readily accessible. Catch basins are not acceptable inside the facility.

## 8.4.15 pH Monitoring and Neutralization: General Requirements

**A. pH Treatment Systems:** Central pH treatment systems are not automatically required in all laboratories;

however, automatic monitoring systems (as a minimum) are required in all lab and ARF buildings. The A/E shall discuss the need for pH treatment systems with the NIH based on the specific facility, though required practice is generally to install pH treatment systems for most lab and ARF facilities, essentially all major lab facilities, and all facilities with a cage wash. Any omission of central pH treatment in a laboratory building shall be subject to approval of ORF and DEP. Refer to [Section 8.4.16 Alternatives to Automatic Central Building pH Treatment](#).

**B. Central Active-Type pH Treatment:** Central pH treatment systems shall be used rather than multiple local passive-type neutralization tanks or multiple pH treatment systems throughout a facility.

*Rationale: Except for remote or highly specialized conditions, multiple pH treatment systems (local equipment) should be avoided to minimize maintenance, chemicals, and operational issues. pH adjustment systems at cagewashers may not be consistently reliable and do not address requirements associated with other chemical and descaler usage as may occur in other areas.*

**C. Treatment Considerations and System Type:** In general, pH treatment systems shall be of the active type, capable of positively neutralizing both acidic and caustic pH to acceptable parameters in consideration of varied inflow rates and pH levels, through use of automatic injection and mixing of acid and base reagents (typically sulfuric acid and sodium hydroxide), monitored and controlled by a local programmable logic controller (PLC). Passive type systems (e.g., limestone or marble chip retention) systems are not acceptable. Systems which require routine opening of systems, straining of waste objects, or other operator contact (whether for replenishment of a media or any other exposure to the waste stream) are not acceptable.

*Rationale: Treatment systems relying on limestone or marble chips are ineffective for alkaline waste streams and not suitable for wastes containing solids or slurry, including cage wash areas and main building lab waste systems. The cleaning and disposal of trapped solids and media of such systems are subject to waste disposal guidelines, can be hazardous, and require extensive maintenance of the systems.*



**D. Full Range pH Control:** With very limited exceptions, all pH treatments systems shall include bidirectional pH control for the full range of pH excursions. Limited specialized applications may be permitted with one-way control, but is not acceptable for cage wash, central or ARF lab waste, and other common applications.

**E. Dilution Systems:** Systems relying only upon dilution, retention (holding or blending tanks), or blending with other waste from the campus are not acceptable.

*Rationale: Achieving adequate neutralization, especially with an elevated, sudden, or intermittent pH excursion is highly unreliable without a robust, controlled active treatment process.*

**F. System Continuity and Reliability:** All systems shall be designed to allow continuous operation of the facility and to ensure that at no time (even when the system is down for service) will building effluent be discharged without continuous pH monitoring or will discharge contraventions occur that may result in damage to infrastructure or violation of maximum permitted excursions.

**G. Monitoring:** Automatic monitoring systems, including critical faults from pH treatment, shall alert to BAS and other locations as designated by the PO. The pH monitor shall incorporate an electronic record for at least 120 days of waste stream characteristics monitored at intervals that do not exceed 5 minutes.

**H. Large Animal Holding Rooms:** Sewage from large animal holding rooms should not discharge through pH treatment systems except where wastes requiring pH treatment will enter drains or discharge through pH treatment is requested by the NIH.

*Rationale: Solid matter can interfere with the treatment process and pose significant maintenance and sanitation issues.*

**I. Excluded Wastes:** pH treatment systems shall not be utilized for receipt or treatment of hazardous, flammable, or grease-laden waste; waste from maximum containment or potential biowaste requiring effluent treatment. Highly concentrated wastes (e.g., tissue digesters) shall be treated locally.

**J. System Compliance:** System design, including chemical reagent storage, equipment, and reagent system piping shall comply with [Section 8.1 Plumbing General Requirements](#).

**K. Standby Power:** The complete pH treatment system, including the system monitor, discharge valve, pumps, mixers, and controls shall be on standby power to ensure continuous drainage, maintain records, and prevent flooding.

### 8.4.15.1 System Location and Planning

**A. Accessibility and Related Considerations:** pH treatment systems shall be fully accessible and unobstructed for service and operation, with restricted access at locations as approved by the NIH. pH treatment equipment (including chemical storage) shall not be located in rooms housing AHUs or mechanical air intakes, or in confined or inadequately ventilated spaces. Location shall allow for pump-out of biomass layers, and replacement of equipment and components. Service access, materials handling of chemicals and required path for delivery of chemical agents shall be identified.

*Rationale: Batch type systems (that drain with each batch through conical tanks or pumps with self-cleaning (non-solids accumulating) tank designs and flush cycles) do not typically require pump out or cleaning, but still must be accessible for service and delivery of reagents.*

**B. Influent Drain by Gravity:** Upper level effluents shall flow by gravity into the system, with only the lowest level that cannot drain by gravity pumped into the system. Where possible, the system shall be located such that treated effluent may discharge by gravity.

*Rationale: This is to minimize reliance on pump equipment for facility discharge, and minimizes the risk of flooding.*

**C. Location, Remote Reagent, and Overflow Protection:** Remote bulk storage chemical tanks and transfer piping to the day tanks may be necessary to reach the treatment system location to allow delivery of chemicals. Where remote fill arrangements are provided, they shall include fail-safe protection against overfilling and other operator

errors. Fill operations shall include an automatic over-fill protection arrangement and remote alarm.

**D. Safe Access:** Reagents and reagent service components shall not be located where work from a ladder or other unsafe practice may be required while handling potentially hazardous components. Controls and components requiring routine maintenance or calibration shall be located with access to facilitate proper maintenance without working above reagent tanks or hazardous locations, including confined space.

**E. Containment:** pH treatment systems (including any equalization tank) shall be located upon slab-on-grade to the extent possible. Wherever a tank is not located over slab-on-grade, with any building occupancy below, the area housing the system shall be diked to contain the entire tank volume and the volume of the connected piping or components. Leak detection is required for diked areas to indicate a critical alert to BAS. The construction of diked areas shall be of monolithic construction with appropriate chemically resistant coating or lining. The use of double-wall tank arrangements may be considered where beneficial. Acid and caustic shall be individually contained.

**F. Treatment and Reagent Tank Locations:** Reactor (treatment) tanks receiving or processing influent shall be located on the floor (or housekeeping pad) within the facility; or may be placed in fully accessible, open top with protective rail (or floor-grated) interior concrete pits with sufficient free space around all sides for inspection, service, and egress. Single-wall tanks shall not be direct buried. Exterior installations are subject to prior approval and adequate protection and access control. No tank may be located in a public area, any area where subject to mechanical damage, or where the normal operation or plausible failures are likely to pose risk to occupants or be subject to tampering or unauthorized access. Chemical reagent tanks shall be located above grade, and shall not be in pits or other locations where safe egress may not be quickly possible in the event of an emergency.

### 8.4.15.2 Equipment Requirements

**A. Equipment Type:** Waste streams with significant solid-matter load or significant pH challenges are better suited to the batch-type process, and for such applications continuous type systems are not acceptable. An

in-line grinder or at a minimum a corrosion-resistant grinding or chopping pump station is required for waste streams with solids, but may not be necessary for all batch system applications. The selected system shall be specially designed to automatically handle the waste-stream solid load and to flush solids without requiring extensive maintenance, routine service, or potential exposure to waste streams.

**B. Control and Safety:** pH treatment systems shall be controlled to prevent runaway reactions or hazardous conditions. The need for fail-safety temperature controls, water purge and similar arrangements shall be provided where required for the specific program application. Refer to [Section 8.1 Plumbing General Requirements](#).

**C. Grinders:** Grinders specified for use with any ARF waste stream shall be selected with consideration of potential presence of hair/stringy or fibrous material. Grinders for lab waste and ARF applications shall be corrosion resistant (typically AISI 329 or 316 stainless steel with approved elastomers and AISI 17-4 stainless cutters), and shall typically be in-line type, except where suitable corrosion-resistant grinder or chopper pumps as part of lift stations with self-cleaning sump basin designs are adequate (refer to lab waste lift pump requirements in this section). A normally closed/locked bypass shall be provided around grinders, or configured with N + 1 redundancy. In the case of large ARF facilities, redundancy for grinders is preferred.

***Rationale:** Waste streams in research laboratories and ARF may receive unexpected solid wastes such as pipettes and gloves. Along with other wastes, dirt, and sediment, collects as scum layers within tanks that do not empty in a batch mode. Where serving cage washers and/or animal holding rooms, additional solid matter may be flushed through drains or bypass in room retention trays, strainers, and sediment buckets. Solid matter can interfere with a rapid treatment process, extend required treatment, be the cause of blockages and built-up solids, and cause problems with pH probes.*

**D. Additional Features:**

1. Waste-treatment systems shall be gas-tight and directly (hard) connected to the receiving building drain or building sewer.

2. Tank material shall be weldable and corrosion resistant, and welding and construction shall be appropriately qualified. UV stabilized polypropylene (typical) or polypropylene lined fiberglass or fluoropolymer lined tanks may be used.
3. Industrial grade mixer(s) shall be provided, sized and positioned for thorough mixing and to minimize solids settling. All shaft and mixer loads shall be sized in consideration of a waste stream with potential solids. Flanged and mechanical seal (preferred) or magnetic mixer arrangements with sealed or non-contact tappings shall be used to maintain gas-tight design.
4. A forced recirculation loop shall be provided to facilitate reagent injection, supplemental and backup mixing, and in-line (out-of-tank) pH monitoring. pH probes, pumps, and controls shall not be mounted inside of treatment, equalization, or reactor tanks. Connections to water supply are not acceptable.
5. Continuous operational reliability is required to maintain continuity of service without disruption. Unless redundant treatment systems are provided, redundant mixers and controls or the use of a circulation loop with self-cleaning plug resistant eductors or jet mixers shall be provided to maintain continuity. Where the system utilizes eductors or jet mixers, the pumps for the circulation system shall be redundant.
6. Holding tanks are unacceptable. Equalization tanks may be used only where such tanks are capable of automatically emptying through a sloped bottom or through automatic solids-handling pump out provisions on a routine basis to prevent solids accumulation and to automatically remove accumulated solids, and provided the arrangement does not disrupt normal operations or processing of waste.
7. pH probe(s) shall include a means to facilitate isolation and retraction for maintenance and drain line cleaning without disrupting the building waste flow. Where pH probes are installed in-line, they shall be arranged to prevent catching solids. Installation in the circulation loop may be required. Removal, malfunction, or

disabling of the pH monitor shall provide a fault alarm to BAS.

***Rationale:** Facilities may operate around the clock. For certain limited service activities the locked bypass loop is permitted as addressed in this section; however, routine operational components shall be sufficiently robust and redundant to minimize potential operation in any bypass condition. With the exception of the influent chamber or appropriately designed lift stations with self-cleaning sump basin arrangements, holding tanks can be high maintenance and accumulate solids. The need for holding tanks can be avoided through adequately sized batch designs.*

8. pH probes, sensor probes, level controls, and all components shall be solids handling or as coordinated with an influent waste grinder and the resulting effluent. Pumps shall be corrosion and abrasion resistant; vortex or municipal grade chopper or grinder type; or air operated diaphragm type; designed to pass or effectively grind the maximum size and type of influent solids, including pipettes and ARF wastes. Valves shall be full-way design to not restrict flow.
9. Systems shall be designed to prevent runaway reactions or other hazardous conditions. Check valves shall be provided on reagent injection lines for safety in event of a reagent control valve or similar failure. Reagent lines shall be provided with tubing shields at all connections where not otherwise double contained.

**E. Batch Type Systems:** Batch type systems may be used for all applications and are required for waste streams with routine solids.

1. Conical (or at a minimum dish) bottom tanks shall be used for high solids conditions. Sufficiently sloping bottom tanks may be used for low to moderate solids conditions.
2. Solids grinding/chopping pumps may be waived in favor of solids handling pumps where in-line grinders have already been provided directly upstream of the pH treatment system. Grinders

are also not required where the application is for low levels of solids feeding directly to batch tanks fitted with solids handling pumps.

3. Redundancy of treatment systems is required unless an equalization tank configured to be self-cleaning and automatically evacuate solids is provided.
4. A gravity flow bypass with automatic pH monitoring shall be provided to prevent facility disruptions and ensure continuous monitoring of pH when a tank is offline for service. Batch tanks that are may operate in a continuous flow through pH treatment mode in event of a single tank being offline for service may also be used where adequately designed.

**F. Continuous-Flow Systems:** Continuous flow systems may be used for lab facilities where frequent or extreme pH excursions are improbable, and provided no cage washers, large animal rooms, or other routine solids containing waste streams are present.

1. Systems shall be continuous-flow type, with hybrid batch control to provide a limited retention and treatment in the event of a spike in the pH of the influent stream. The typical reserve freeboard shall provide at least 3–5 minutes of retention.
2. A gravity-flow bypass with automatic pH monitoring shall be provided to prevent facility disruptions and ensure continuous monitoring of the waste stream pH. Alternatively and where approved by the NIH, N + 1 redundant online treatment systems may be provided.
3. An in-line grinder or grinder/chopper pump is recommended for low levels of solids applications, but not required where serving only labs in small facilities that do not have extensive floor drains, troughs, or other significant solids sources.
4. Wherever redundancy of units is not provided, a gravity flow bypass with automatic pH monitoring is required to preclude facility disruptions and ensure continuous monitoring of pH.
5. Systems shall not include or require in-line waste strainers or other components requiring routine maintenance or opening of the system.

**G. Equalization Tanks:** Equalization tank use shall be subject to justification and approval, and where provided shall be designed to automatically clean, handle, and prevent solids accumulation. A normally closed bypass shall be provided to permit service.

### 8.4.15.3 pH Treatment System: Equipment Sizing and Design Requirements

**A. System Size and Treatment Time:** Continuous-flow active-type systems shall provide at least 3–5 minute-influent equalization (first stage) and a minimum 10 minute treatment, in addition to a 3–5 minute free-board for hybrid-batch operation. Batch-type systems shall provide at least 10–20 minute treatment, unless approved by NIH. Where over a 30 minute-retention time is required, provide calculations and justification for NIH approval.

*Rationale: Systems shall be engineered for efficient operation without significant oversizing as unnecessarily large systems result in significant capital costs and maintenance.*

**B. Load/Throughput Calculations:** System loads and resultant sizing shall consider facility equipment and throughput calculations, including required 20% overage.

**C. Continuous Facility Operations:** A normally closed and locked bypass discharging by gravity flow through a pH monitor/recorder shall be provided to facilitate continuous facility operations in the event of system failure or routine maintenance.

**D. Reagent Piping:** Where reagent is piped from a remote location, the transfer lines shall be free draining, and all piping that is not exposed within the chemical equipment handling room shall be double-contained and automatic leak monitored. Approved metallic piping with butt weld joints only is required; e.g., T304 or 316 seamless of min. schedule 40 for sodium hydroxide and Type A53 Grade B seamless extra strong or Alloy 20 (not less than schedule 80) for sulfuric acid. Piping shall be located only in accessible, non-sensitive, spaces that are not exposed to mechanical or environmental hazards. Reagent pipelines, tanks, and equipment shall be designed and installed in accordance with ASME B31.3 and [Section 8.1 Plumbing General Requirements](#) by a qualified chemical/process



piping engineer and subject to ORF approval. Caustic lines shall be heat traced with self-regulating electric type heat trace cable where any portion of the piping passes through an area with a temperature below 18°C (65°F). Caustic system design and installation shall be in accordance with recommendations of Chlorine Institute Pamphlet 94. Reagent line valves shall include live loading packing designs, and shall be suitable for the application. The use of compatible plastic piping (typically fusion joint polypropylene) may be accepted for near equipment piping between the day tank and reactor, only within the equipment room where protected from mechanical damage. Electrofusion joints are not acceptable.

**E. Reagent Selection:** In most cases at the NIH, sulfuric acid and sodium hydroxide should be utilized, and alternatives shall be justified. Typical concentrations for both caustic soda and sulfuric acid shall be 25 to 50%, unless justified. CO<sub>2</sub> is not typically acceptable for central lab waste systems, but may be applied for certain dedicated alkaline waste streams where sourced independent of other bulk gas supplies.

**F. Room Piping:** Localized reagent piping within the pH treatment room may be Schedule 80 PVC, CPVC, or polypropylene infrared (IR) butt fusion for caustic. It may be either minimum Schedule 40 IR fusion joint PVDF, or minimum Schedule 10 carbon steel or stainless steel welded joint for sulfuric acid.

**G. Storage Temperature:** Adequate heating shall be provided to prevent temperatures from dropping below 18.3°C (65°F) where sodium hydroxide is stored or transported.

*Rationale: Caustic soda viscosity substantially increases above 18.3°C (65°F). If such conditions cannot be met, a 25% solution shall be utilized.*

## 8.4.16 Alternatives to Automatic Central Building pH Treatment

**A. pH Monitors:** The omission of pH treatment systems requires NIH approval for lab and ARF facilities. At

a minimum, provision of automatic pH monitors are required. pH monitors may be installed in lieu of central pH waste water treatment systems in the following configurations. Such provisions are generally not acceptable for new lab facilities or major ARFs, regardless of provision of neutralization at cage wash equipment.

1. The exiting lab waste system shall be provided with continuous automatic monitoring at not more than 5 minute intervals and maintenance of an electronic record for at least 90 days. The monitor shall provide immediate alert to the BAS, including a fault alert if the monitor is removed or offline.
2. The pH probe shall be designed for use with waste streams handling solids. Signage shall be provided warning of pH probes similar as described in the DRM for backwater valves. Refer to requirements outlined for pH treatment.
3. Monitoring systems shall be arranged and planned to accommodate the addition of an appropriate pH treatment system to comply with discharge requirements for lab/ARF waste should one become necessary. The pH probe shall be installed in the main lab waste leaving the building (prior to combining with sanitary), within a flow-through sampling basin or other appropriate flow cell. A normally closed locked and automatically monitored (tamper switch to BAS) bypass shall be provided to facilitate continuous building operations. The probe shall be self-cleaning and continuously wetted, with special care applied for systems subject to heavy solids or slurry loading. A service access pit shall be provided for full access.
4. For extramural projects/grant projects, manual grab sampling from pH sampling manholes may be used in lieu of automatic monitoring, but only where approved by the local AHJ. In such cases, the corrosion-resistant lab waste piping system shall extend to the sampling manhole before any change to non-chemically resistant site-utility-piping materials.

**Rationale:** *These provisions set forth an alternative to pH treatment that may be acceptable for limited applications where building operations and the types of waste generated are unlikely to produce pH excursions in violation of discharge regulations, and to provide record of conformance with discharge regulations.*

## 8.4.17 Grease Waste and Fats, Oil, and Grease Control: Additional Requirements

**A. Treatment Required:** Waste pretreatment to effectively capture fats, oil, and grease (FOG) is required for all food service establishments at the NIH.

**Exception:** *Waste pretreatment is not required where food or beverages are sold only in prepackaged, unopened original containers and no warewashing activities are provided.*

**B. FOG Sources:** Pretreatment is required for all FOG sources, including sources of animal- or vegetable-origin oils or dairy grease.

**C. Dedicated Grease Waste Systems:** Dedicated grease waste systems shall serve commercial food service areas and other areas of the facility as necessary to prevent the discharge of FOG to the campus sewer system and maintain NIH compliance with discharge regulations.

1. Waste from pre-scrap sinks of commercial food service areas shall discharge to the exterior gravity grease interceptor, whether or not such sinks are fitted with disposers. Prewash and wash compartments of food service warewashing sinks shall discharge through the grease interceptor. Where disposers are provided at the warewashing area, a dedicated, effectively designed, and adequately sized solids interceptor arrangement shall be provided ahead of the grease interceptor to prevent pass through of solids. The solids interceptor shall be designed for pump-out cleaning operation. Solids-interceptor-retention capacity shall be at least 30% of the required interceptor volume, or greater as calculated.

Appropriately designed three-compartment interceptors may be oversized to serve this function. Disposers may be omitted at prescrap and similar sinks to avoid the need for a solids interceptor. Waste from toilet rooms, mop sinks, cold condensate, and waste streams that may emulsify grease through the interceptor shall not be connected to the interceptor.

**D. Interceptor Type and Criteria:** An exterior gravity grease interceptor of not less than two compartments shall be provided to serve the waste stream from all commercial food service facilities using cooking appliances and a grease hood, or where a commercial dishwasher is required.

1. Grease interceptors shall be designed and sized to ensure maximum 100 mg/L FOG concentration in the effluent waste stream without short circuiting. A minimum 30 minute retention is required. The exterior gravity grease interceptor shall be located in ground as close as possible to the food service clean-up area, at an exterior location, within a maximum 15 m (50 ft.) of pump-out truck access, at an exterior service area, with the location preapproved by the ORF. Interceptors shall be located where replacement may readily occur without damaging building structures, and access ports and manways shall be fully accessible and uncealed. Interceptors shall be of impervious, corrosion resistant construction (e.g., fiberglass or polypropylene), and shall be water and gas-tight (including risers and tops).
2. Grease interceptors shall be placed in the system only at a point to receive stabilized, uniform flow from gravity-flow grease waste collection systems. Grease interceptors shall not receive discharge from sewage pumps or ejectors or other sources of elevated pressure.
3. Exterior gravity grease interceptors, anti-flotation, and manway access arrangements shall be of appropriate structural design for the application, and at a minimum shall be suitable for AAHSTO H20 traffic loads regardless of location. Interior piping shall be at least Schedule 40, solid wall (no cellular core materials). Interceptors shall be provided with internal corrosion resistant ladders with non-slip rungs.



4. Where a gravity grease interceptor must be located within the structure (e.g., within parking garages), the interceptor shall be located in an environmentally controlled space (not subject to freezing). Grease interceptors are not acceptable inside the building.
5. Grease interceptors shall be sized so as not to require cleaning more than once per 45 days, and shall not exceed 25% full of FOG and solids within this time period.
6. The final high temperature dishwasher rinse shall be piped through a separate floor sink plumbed to the sanitary system, or ensure the dishwasher is provided with an after-cooler to limit waste water temperature to 60°C (140°F) for discharge to the grease waste system along with pre-wash and wash compartments.
7. The sanitary vent downstream of the interceptor shall connect directly to the vertical cleanout riser with a wye-type fitting to minimize potential for stoppage of the vent. The tank vent and sanitary vent shall not be combined until a minimum 970 mm (38 in.) above the finished floor and shall be fitted with cleanouts. The vent shall slope to drain and shall be provided with a cleanout. Two-way directional cleanouts shall be provided at both the inlet and outlet of each tank. The discharge from the interceptor shall be direct to the sanitary sewer manhole or exterior sewer lateral.

**E. Minimize Stoppages:** The drainage design shall produce a minimum velocity of 0.9 m/s (3 ft./s).

**F. Grease Interceptor Remote Location:** In cases where the grease interceptor is unavoidably remotely located at extended distances from the kitchen or FOG source, the grease waste line shall be provided with industrial-grade heat tracing and a suitable insulation system.

**G. Grease Traps/Flow Based Grease Interceptors and Hydromechanical Type A:** Point of use grease traps are not permitted, except for limited applications (e.g., where a single wash sink or group of not more than four fixtures is provided as part of a limited remote area) where an exterior gravity type grease interceptor installation would not be practical or justified. Use of grease traps is limited to low risk applications, such as coffee

bars or similar areas with no cooking or washing of items of significant FOG risk. In addition:

1. Use of grease traps in lieu of exterior gravity-type grease interceptors shall be subject to justification and NIH approval.
2. The application of grease traps shall be in accordance with current WSSC Plumbing Code for Flow Based Grease Interceptors.
3. The program operator shall submit details of maintenance and best management practices. Grease traps (where permitted) shall be cleaned at intervals not to exceed weekly. Where this cannot be accomplished, use of an exterior grease interceptor is required.
4. Only one grease trap is permitted to serve any single food service area. Where multiple traps would be required, utilize an exterior grease interceptor and grease waste system.
5. Grease traps shall not serve dishwashers, disposers, or hood wash applications.
6. Grease recover devices, including ASME A112.14.4 type are not acceptable. Grease traps shall comply with ASME A112.14.3.
7. The minimum-size grease trap shall be rated at 20 gpm.
8. The total liquid volume capacity of fixtures connected to the grease trap shall not exceed 2.5 times the grease trap manufacturer's certified flow rate.
9. A vent shall be installed downstream of the grease trap in accordance with trap arm limitations.
10. Grease traps shall be elevated above the floor (on non-corrosive legs) to facilitate cleaning.
11. Grease trap draw-offs, skim systems or similar arrangements are not permitted.
12. The installation arrangement of the flow control vent for the grease trap shall not result in a bypass condition of sewer gas into the building around the trap seal.

13. Grease traps shall be located only where flow is stabilized and uniform, and shall be appropriately sized for that peak flow rate.
14. Grease traps shall be located in unconcealed, readily accessible spaces. Locating grease traps in closets or spaces not in routine use is prohibited.
15. To the greatest extent possible, the A/E shall avoid locating grease traps in food preparation, warewashing, food storage, clean dish areas of kitchens, or other areas of public health concern. Location shall be subject to NIH approval.
16. Discharge of grease traps shall be direct connected to the drainage system. All fixtures discharging to a grease trap shall be properly trapped and vented or discharge indirectly through a properly trapped and vented receptor.

*Rational: Health concerns dictate that grease traps and their maintenance should not be located/performed in food prep or other sanitary areas.*

**H. Private, On-site Waste Treatment System Grease Interception:** For applications discharging to private, on-site waste treatment systems, the use of two interceptors in series or a suitably designed three-compartment interceptor may be required.

**I. Calculations:** The A/E shall submit all grease interceptor, grease trap, and solids interceptor design and sizing calculations for NIH review and approval.

## 8.4.18 Non-Emulsified Oil-Based Waste

**A. Oil-Water Separator/Interceptors:** Oil-water separators/interceptors shall be provided to serve potential sources of non-food service based oil discharge and engineered to provide effluent discharge levels of solvent-extractable matter of mineral or synthetic origin to a maximum of 10 ppm and total suspended solids to a maximum of 350 ppm. The use of coalescing filters or advanced treatment configurations may be required and shall be determined on an application-specific basis.

**B. Coalescers:** Where coalescers are utilized or are provided to meet discharge regulations, an upstream solids-separator arrangement shall be provided where waste streams contain solids.

**C. Location:** Interior installation is not permitted except as approved by the DFM.

**D. Double-Wall Construction:** Where units will contain any significant oil volume or any hazardous fluid, double-wall construction is required. Double-wall construction with monitoring is required for any buried unit, except incidental separators provided for routine impervious surface drainage not associated with a specific oil or flammable liquid source.

**E. Metal Construction:** All piping systems discharging into and venting oil interceptors or serving flammable liquids shall be of approved metal construction. Flammable waste systems shall be in accordance with the requirements of NFPA standards.

**F. Combustible Gas Detection Meter:** Where flammable liquid or combustible gases would be present, waste interceptors shall be monitored with a combustible gas detection meter, alerting to the location as approved by the ORF and DFM for each application. Compliance with NFPA-30 is required.

**G. Sizing Calculations:** The A/E shall submit sizing calculations and their basis and justifications of retention time and the design arrangement. Sizing calculations shall consider presence or absence of a coalescer or other subsequent treatment steps and presence of emulsified oil and surge influent conditions.

*Rationale: Provisions are required to protect the infrastructure from flammable liquids and oil discharges, and to ensure conformance with waste discharge regulations.*

## 8.4.19 Condensate Drainage

**A. WSSC Service Area Projects:** For NIH projects in Montgomery and Prince George (PG) counties, Maryland, clear water, non-contaminated atmospheric condensate shall discharge to the storm system, unless

approved or directed by the NIH or WSSC service area plumbing code.

**B. Contaminated Condensate:** In all cases, chemically contaminated condensate (e.g., steam humidifier waste and waste from coil cleaning) shall discharge as indirect waste only to the sanitary system.

**C. Sanitary Discharge:** For projects outside of the WSSC service area discharge of all condensate wastes to sanitary systems is preferable where acceptable by local AHJ, or may be discharged as outlined in this section subject to approval of the AHJ.

***Rationale:** Discharge to a sanitary system is preferred. This approach avoids reliance upon maintenance technicians and others to follow protocol and avoids accidentally discharging cleaning chemicals.*

**D. Connections to Sanitary System:** Route individual connections or local grouped connections as indirect waste, with a proper air break to an adequately sized receptor.

**E. Connections to Storm System:** Refer to [Section 8.4.20.4 Clear Water Waste Connections](#).

**F. Air Handler-Unit (AHU) Drainage:**

1. Non-contaminated atmospheric condensate shall discharge to storm as clear water waste, and be fitted with a normally closed bypass arrangement with a valved connection and threaded cap near the AHU to permit extension of a hose to a sanitary drain for use during coil cleaning operations. The termination shall be provided with a male thread hose fitting to receive a conventional garden hose. Where constant contaminated drainage or high flow capacity is required or where otherwise beneficial, provide a sanitary floor drain or floor sink near to each equipment along with a clear water waste receptor or clear water standpipe to storm that extends at least 25 mm (1 in.) above the floor slab. Bypass valving and permanent labeling shall be provided to facilitate proper use.

2. Drainage from steam humidification shall be

separately collected, and if discharging to the building drainage system, shall discharge only through the sanitary system with an after-cooler either through a standpipe receptor or to a floor sink or other suitable indirect waste receptor.

3. Special care shall be taken in the installation of any floor drains, standpipes, and floor sinks to maintain full insulation of the drain and drain body, and to adequately seal arrangements to prevent leakage around the drain perimeter to the floor below.

**G. Condensate Drain Line Slope:** Condensate drain lines shall slope a minimum of 20 mm/m (2%) and shall be a minimum 25 mm (1 in.) diameter if over 4.5 m (15 ft.) long, and in no case smaller than 20 mm (0.75 in.).

**H. Condensate Line Fittings:** All pipe fittings shall meet the radii requirements of plumbing drainage systems. Type ACR long pattern copper fittings, Type DWV copper fittings, and arrangements of multiple 45 degree ellips may be utilized to achieve acceptable directional pattern.

**I. Cleanouts:** Cleanouts shall be installed at each aggregate change of direction exceeding 135° (starting from the downstream end), at the end of each horizontal line, and at least every 15.25 m (50 ft.), except that not more than one cleanout is required every 12.2 m (40 ft.), provided the aggregate change of direction does not exceed 270°. Pipe sizes 40 mm (1.5 in.) and larger shall be provided with cleanouts as required for drainage systems.

**Table 8.4.19 Condensate Line (Indirect Waste) Sizing**

Pipe Size mm (in.)	Maximum Cooling Load in W (ton)
25 (1)	Up to 17,050 (5)
32 (1-1/4)	Up to 102,300 (30)
40 (1-1/2)	Up to 170,500 (50)
50 (2)	Up to 511,500 (150)
Run multiple condensate lines	Above 511,500 (150)

## 8.4.20 Storm, Clear Water Waste and Specialty Systems: Additional Requirements

**A. Primary and Secondary Systems:** Combined primary and secondary systems are unacceptable regardless of configuration. Storm drainage systems shall be conventional atmospheric pressure gravity type that does not rely on storage of water on the roof, special drain weirs, or siphonic arrangements. Any required storm water retention shall occur outside away from the structure. At least two drainage points shall be provided for each roof area, and no drain shall have an outlet size smaller than 75 mm (3 in.) diameter.

### 8.4.20.1 Primary Storm and Secondary Overflow Storm Drain-System-Sizing Criteria

**A. Storm Drainage System Sizing:** The primary storm drainage system shall be sized based on a criterion of at least the 100 year, 60 minute storm, which for the Bethesda campus corresponds to a rainfall rate of approximately 94 mm/hr. (3.7 in./hr.), in addition to required overage factor and any connected clear water loads. In no case shall sizing be less than permitted under code or recommended by the structural engineer.

**B. Sizing Overage Factor:** A minimum of a 10% overage factor shall be applied to the sizing of all storm drain piping to accommodate future building clear water wastes, over and above calculated loads. Therefore, actual sizing when utilizing the 100 year, 60 minute storm shall be at least 102 mm/hr. (4 in./hr.).

**C. Clear Water Waste Loads:** The clear water waste loads from any permitted sources (as per [Table 8.4.1](#)) shall be added to the peak load for all segments, mains, branches, and leaders that will carry such load. The resultant sizing shall include at least a 20% overage for those loads, added to the flow rates associated with the base (102 mm/hr. [4 in./hr.]) system sizing.

**D. Secondary Overflow Drainage/Scupper System Sizing:** The secondary overflow drainage/scupper system shall be sized based on at least the 100 year,

15 minute storm, which for the Bethesda campus corresponds to a rainfall rate of approximately 183 mm/hr. (7.2 in./hr.). In no case shall sizing be less than permitted under the applicable building code or recommended by the structural engineer.

***Rationale:** Inadequate roof drainage and water infiltration is one of the most significant causes of facility failure and litigation. Although some codes have recently changed to permit reductions in the sizing and configurations of emergency overflow systems, the NIH utilizes the more rigorous extensively applied and historically proven criteria associated with critical facilities.*

**E. Lower Roof Areas:** Neither primary nor secondary roof drainage may spill from one roof area onto a lower roof. Each primary roof drain shall be connected directly to the storm drain system and each secondary overflow drain shall be connected directly to the overflow drain system. Oversizing of drainage for lower roof areas and provision of monitoring devices is not considered equivalent.

### 8.4.20.2 Primary Storm and Secondary Overflow Storm Drain: Additional Requirements

**A. Expansion/Movement Joint:** An expansion joint or acceptable horizontal offset (swing joint) shall be provided at connections to each roof and overflow drain unless determined unnecessary and not required by the roof system's manufacturer.

**B. Rainwater Leaders Connection:** Lower roof areas and other outlet tapings shall not be connected to rainwater leaders within 600 mm (24 in.) of a horizontal offset, and then only with wye-type fittings.

**C. Drain Selection:** Roof and overflow drains shall be compliant with roofing system manufacturer requirements. Roof drains shall include sump receivers and cast iron (not plastic) domes and underdeck clamps.

**D. Fittings:** Fittings specified for directional changes and branches in storm drainage systems shall be of the same long-radius type required for use in sanitary systems.

**E. Insulation:** The entire storm and overflow drainage system (including vertical piping and drain bodies) shall be insulated. Insulation of only horizontal piping is unacceptable.

**F. Overflow Drains:** Roof and overflow drains shall include sump receivers, underdeck clamps, and aluminum or cast iron domes. Overflow drains shall be provided with a fixed weir, set at appropriate height as coordinated with the structural engineer. For overflow systems, the weir shall be at 50 mm (2 in.) unless determined necessary and approved by NIH, and shall be located along with the roof drain at the low point for each drainage area. Overflow drains shall discharge through downspout nozzles above but near finished grade.

### 8.4.20.3 Area Drainage

**A. Drain Provision and Size:** Adequately sized area drainage with outlets of least 75 mm (3 in.) diameter shall be provided for exterior walkways, stairs, and as necessary to prevent accumulation of water.

**B. Water Accumulation and Drain Inlet Sizing:** Area drains should generally be sized to relieve peak rainfall with a maximum 7 mm (0.25 in.) head.

**C. Dome Tops:** Area drainage in area walkways, window wells, and near landscaping or where subject to blockage shall be provided with dome tops; however, domes shall be located to prevent a tripping hazard.

**D. Pavers:** Area drainage in areas provided with pavers shall be arranged to discharge both surface drainage and accumulated flow below the paver through use of specially designed promenade-type perforated drains.

**E. Stair Areas, Walkways and Landings:** Provide adequate drainage to prevent water accumulation and minimize potential for ice. Trench drains may be utilized as appropriate.

**F. Grates:** The grate of all area drains (including trench drains in pedestrian walk areas) shall be sufficient for the anticipated traffic loading and conditions (pedestrian, vehicular, etc.) and to minimize tripping or fall hazards.

### 8.4.20.4 Clear Water Waste Connections

**A. Clear Water Waste Discharge:** The criteria provided in [Table 8.4.1](#) shall be used to determine where various services are piped.

**B. Connection Location Prohibitions:** Standpipes and clear water waste receptors shall not connect to the storm drain system in locations subject to backflow from storm water surges. Backwater valves on standpipe drains shall not substitute for provision of dedicated leaders or for provision of adequately sized piping systems with branch lines connected to wye-branches into rainwater leaders away from horizontal offsets and surge zones.

**C. Clear Water Drain Connections to Storm System:**

1. Waste discharge to the storm system shall ideally connect indirectly by spilling to an exterior catch basin or similar arrangement or to an approved exterior location spilling to the site storm system in such a manner to not present hazards, puddles, or ice. Water shall discharge as a connection into or directly over an appropriate waste receptor. It shall not flow across impervious surfaces or areas where saturation is likely.

*Rationale: This avoids any potential of backflow or flood openings into the building.*

2. The approach of connection only to dedicated leaders that serve only clearwater waste and not serving storm drains should be followed to the extent possible.
3. Where dedicated leaders are not possible (existing construction), connections directly to the storm system may also be made, provided the leader is adequately sized and the connection arrangement is not subject to flooding, backflow, or infiltration of air or vermin.
4. All connections shall be made as an air-break (indirect) connection into receptors that are at least 25.4 mm (1 in.) above the floor.
5. Connections shall be made to vertical risers with upright wye-pattern fittings, away from areas of potential pressure surges (such as near offsets), or into flow-stabilized sections of horizontal



pipng with wye-pattern fittings rising above the top of the main.

6. Within the building, traps shall be provided to serve each clear water waste receptor and shall be provided with a vent. Storm system/clear water vents shall route to the exterior and shall not be combined with sanitary or other plumbing system vents. Backwater valves may be added where required but are not a substitute for traps and vents. Standpipes and receiving drains within the building interior shall be insulated. The minimum size indirect waste receptor from the storm drain system is 75 mm (3 in.) diameter.
7. Connections within the building shall be located only in suitable locations (e.g., mechanical rooms) where a backup or overflow would not induce significant damage and floor drains are nearby.

*Rationale: Traps are required to protect from air and insect/vermin infiltration. Due to the high-flow nature of storm drain systems, individual vents are required to maintain trap seals. Backwater valves do not protect from vermin.*

#### 8.4.20.5 Underslab/Subsoil and Foundation Drains

**A. Systems:** Underslab subsoil drainage piping shall be provided for slab on-grade and buried structures where recommended by the geotechnical or structural consultant.

**B. Specifications:** The underslab/subsoil drain system shall be designed, positioned, and spaced as per the geotechnical engineer's recommendations, using at least 100 mm (4 in.) diameter perforated laterals and at least 100 mm (4 in.) or 150 mm (6 in.) mains as required, with geotextile filter fabric and a positive slope of not less than 0.5%. The arrangement and associated details shall be coordinated with the structural and geotechnical engineer. Strict conformance to geotech engineer recommended granular backfill and anti-buycancy provision is required. Sufficient cleanouts are required to permit cable cleaning or hydrojetting and shall include system specific labeling (e.g., foundation drain) on access covers.

**C. Sump Pump Placement:** Where a sump pump is required for subsoil drainage, it should be located at the building exterior if feasible and not subject to freezing, consisting of two pumps sized for N + 1 redundancy on standby power.

*Rationale: Exterior location, typically for submersible pumps, in some conditions can ensure that even under failure conditions water backup occurs outside rather than potentially flooding basement areas/slab on-grade.*

**D. Subsoil Drainage Connections:** Areaway drains, rain leaders, downspouts, condensate, clear water drainage, or other above-ground drainage points shall not be connected to subsoil drains.

**E. Sand Traps/Catch Basins:** An exterior sand trap or catch basin shall be provided where subsoil drains connect to the storm drainage system.

**F. Backwater Valve:** Where subsoil drains connect to the storm drainage system without the use of pumps and could be subject to backwater backflow, an accessible automatic backwater valve shall be provided at the sand trap to prevent reverse flow of storm water into the subsoil drains.

**G. Storm Water Vents:** Whenever storm water vents are required e.g., for sealed sumps or any waste receptor), they shall be piped independently of any sanitary vents.

**H. Radon Mitigation:** Where radon mitigation is necessary, justification for approach, materials and arrangement shall be provided for review prior to design.

#### 8.4.20.6 Gravity Drainage (Storm) and Backflow of Waste

**A. Elevated Building Areas:** Building areas, which are sufficiently elevated above the storm drains so as not to require discharge through a pumping system, shall be routed independently to discharge by gravity.

**B. Backflow of Low-Level Storm Water Inlets:** Systems shall be arranged so that a stoppage in the exterior storm sewer shall not result in storm water backflow into low-level storm water inlets that are not fully exterior of the building. Systems shall be designed such that storm water shall be relieved outside the building.



**C. Backwater Valves:** Where such drains are located less than 230 mm (9 in.) above the elevation of the storm water relief point, automatic backwater valves shall be provided. Roof drains and other drains with flood-level rim elevations above the reference point shall not discharge through the backwater valve. Drain openings with flood-level rims that are not located above the crown level of the storm sewer shall be pumped.

### 8.4.20.7 Parking Garage Drainage

**A. Garage Drainage Systems:** An independent garage drainage system shall be provided for parking garage drains below the top parking deck that is not directly exposed to rainfall.

**B. Garage Drain Type:** Garage drains shall be of the dry-pan type (connected without traps), have at least 100 mm (4 in.) diameter outlets, and include a sediment bucket and ANSI special load class ductile iron secured grate and anchor flange.

*Rationale: The provision of dry pan drains eliminates requirements for freeze protection of traps and prevents accumulation of oil or flammable liquids in trap seals.*

**C. Interceptor, Discharge Location for Intermediate and Enclosed Decks:** Except for the top deck exposed to rainfall, the garage drains shall collect to a common minimum 150 mm (6 in.) diameter collector line that discharges to an oil/sand separator designed to ensure discharge does not exceed 100 ppm oil. The interceptor shall incorporate a 150 mm (6 in.) deep submerged water trap seal at the inlet and a 450 mm (18 in.) deep submerged seal at the outlet, and a dedicated vapor vent direct to the exterior terminating at least 2.1 m (7.0 ft.) above the highest parking deck and away from any air intake or building opening. An automatic electrically actuated trap seal primer shall be provided to ensure continued maintenance of the interceptor trap seal. The discharge of this interceptor shall be direct to the site sanitary sewer.

**D. Garage Drain Locations:** Garage drains shall be located at low points adjacent to ramp turnabout and at sufficient intervals to reasonably facilitate garage floor washdown and to prevent puddling.

**E. Backwater Valves:** Backwater valves shall be provided where necessary to protect from flooding due to the elevation of the drains.

**F. Parking Garage Top Deck:** The top deck of the parking garage exposed to rainfall shall be directed to the storm drainage system independent of the storm main serving occupied buildings. The requirements for an oil/sand interceptor to serve the top deck drainage shall be determined based on the most current requirements of discharge regulations (Montgomery County, MD requires an oil interceptor prior to release to the waterway). An interceptor is typically required unless handled downstream prior to release to waterways or retention basins, and subject to approval of ORF and DEP.

*Rationale: The top deck is independent of lower level drains to facilitate handling of the increased loads of storm water. Segregation from the building system is to address present or future likely requirements for interceptors to serve waste water from impervious areas.*

**G. Trench Drains:** Trench drains shall be provided at parking garage ramp entrances and exits to prevent water buildup.

**H. Heel-Proof Drains:** Heel-proof drains shall be provided at any stair landing exposed directly to rainfall from sides or above, and shall have outlets at least 75 mm (3 in.) diameter.

### 8.4.21 Sump, Sewage, and Lab Waste Pumps

**A. Pump System Requirements:** Sump, sewage, and lab waste pumps shall be municipal duty (municipal lift station) grade, submersible type, and provided with lift rail, lead-lag-alternate controls, and designed to prevent single point failure (N + 1 redundancy).

1. Sewage and lab waste pumps shall pass at least 75 mm (3 in.) diameter solids, and shall be vortex type, except that semi-open, self-cleaning multi-vane-type non-clog impellers may be used where receiving only sanitary (not lab or animal) wastes and the pump is specifically designed for sanitary sewage in municipal applications. Provide with corrosion resistant floats, guided wave radar or other approved level and alarm control.
2. Pumps receiving waste from lab, cage wash, and animal areas shall be vortex type, designed for use with corrosive liquid wastes with a high solids content, municipal duty grade, pass at least 75 mm (3 in.) diameter solids, with AISI 329 stainless steel (or not less than AISI 316 stainless steel) wetted parts (or approved equal or better as required), corrosion-resistant floats, guided wave radar, or other approved level and alarm control, and corrosion-resistant accessories.
3. Pumps for storm systems (including sump pumps) shall pass at least 32 mm (1.25 in.) solids and be suitable for abrasive waste streams. Pump systems serving subsoil/underslab drainage, critical applications, or any application serving more than one drain or multiple areas shall be provided with at least two pumps for N + 1 redundancy, municipal duty grade and shall be on building standby power. Provide with corrosion resistant float control.

**B. Sanitary Sewage Basins:** Sanitary sewage basins shall be of acid-resistant, reinforced sulfate-resistant concrete with two coats of high-performance epoxy, or an industrial/municipal lift station-quality plastic sump of either fiberglass encased polypropylene or chemical resistant fiberglass construction with a sealed cover. Sump, frame, and lid construction shall be gas-tight, and rated for traffic in the area installed, but in no case less than pedestrian and light wheel traffic. Tanks shall be designed for a normal operating temperature of at least 82°C (180°F). Where coatings are applied, the A/E shall specify application by an SSPC CAS (Society for Protective Coatings, Coating Application Specialist) Level 2 or better installer.

***Rationale:** Sanitary sumps must be sufficiently resistant to hydrogen sulfide gas and routine chemicals and cleaners.*

**C. Waste Basin Locations:** Sewage and lab waste basins should be located away from occupied spaces, return air openings, and outside air intakes. Coordination with the mechanical/HVAC engineer is required to prevent odor infiltration.

***Rationale:** Even where basins are fitted with appropriate gas-tight seals, maintenance activities can lead to migration of odors that should be contained within appropriate mechanical spaces.*

**D. Lab-Waste-Pump Basins:** Basins for lab waste pumps shall be of an industrial/municipal lift station-quality fiberglass encased polypropylene tank, arranged as a tank in a pit arrangement. Direct burial of single wall tanks is not acceptable. Sump, frame, and lid construction shall be gas-tight, and rated for traffic for the area installed, but in no case less than pedestrian and light wheel traffic. Tanks shall be suitable for a normal operating temperature of at least 82°C (180°F). Polypropylene or PVDF lined water-tight concrete sumps may also be used subject to completely fused joints and leak-tight construction.

***Rationale:** Lab waste systems are subject to corrosive chemical wastes, routine cleaners, and disinfectants, hot water wastes, and potential exothermic reactions. Fiberglass or approved corrosion resistant metal reinforcement is required for structural and impact strength. Polypropylene is required for temperature resistance. The use of an accessible tank in a pit (ideally indoors) facilitates routine inspection and maintenance.*

**E. Self-Cleaning Basin Design:** Basins for sanitary system applications and basins receiving waste from ARFs, lab, or cage wash areas, and other effluents carrying slurry or solids shall incorporate a self-cleaning sloped bottom design to automatically remove solids, and shall also incorporate an automatic flush system.

***Rationale:** Solids from animal areas and cage wash bedding and slurry can create excessive maintenance issues, stoppages, and malfunctions if not appropriately addressed through solids-handling equipment and basins.*

**F. Pneumatic Ejector Systems:** In lieu of pump-based lift stations, pneumatic ejector systems may be utilized for sanitary and lab waste. Ejectors shall be provided with cast iron receivers for sanitary applications and 316 stainless steel receivers and wetted parts for lab waste. Alternative corrosion-resistant materials shall be used for waste streams with significant chloride concentrations.

***Rationale:** Pneumatic ejector stations provide durability and solids handling capability when fitted with properly designed receivers.*

**G. Standby Power and Redundancy:** Sewage and sump pump lift station and ejector arrangements shall be served from standby power systems and designed to provide N + 1 redundancy including pumps, air compressors/air supply, and control arrangements. High-water alarms and pump failure shall alert to the BAS as a critical fault.

**H. Elevator Pit Sump Pumps:** Elevator pit sump pumps shall be of an oil-preclusion type except that standard sump pumps may be used for electric traction elevators with no hydraulic oil lines. The pump shall include a high-water/general fault alarm to the monitored BAS.

**I. Elevator Pits' Discharge:** The discharge from elevator pit drains and elevator sump pumps shall spill indirectly to the sanitary drainage system through an air break into a hub drain or floor sink.

## 8.4.22 Quality Assurance, Startup, and Verification

**A. Code and Contract Requirements:** Systems shall be tested in accordance with code and requirements of this section, and verified to be installed in accordance with the contract documents prior to concealment.

**B. Calibration/Commissioning:** Pump systems, treatment systems, controls, instruments, devices, and alarms shall be calibrated and individually verified for proper operation and adjustment, including but not limited to activation points and alarms. Systems shall be fully commissioned including all critical parameters, proper response to power-loss scenarios, failure conditions, monitoring, and alerts, including integrated systems testing.

**C. Lift Stations and Waste Treatment Equipment:** All lift stations and waste treatment equipment shall be inspected for compliance with this section, verification of removal of any construction debris, all required safety devices and features, and proper condition of tank liners, materials, and venting.

**D. Systems Testing:** All systems shall be inspected and tested prior to backfill, prior to concealment, and again at final completion in accordance with plumbing codes. The following additional criteria is required:

1. Lab and ARF waste downstream of fixture traps shall be tested for at least 4 hours prior to concealment. A 3.0 m (10 ft.) water head is required, except that a 1 hour air test at 34.5 kPa (5 psi) may be conducted for metallic systems with suitable joints and other systems deemed appropriate by the manufacturers and A/E for such testing.
2. For large facilities under new construction or significant renovation, video inspection of underground drainage systems (including piping under building slabs) should be considered. Reports of tests shall be reviewed by the A/E, who shall notify the PO of any issues. Video record and reports should be incorporated in project O&M manuals where such testing is provided.

***Rationale:** Video inspection can provide final indication of conditions of installation after the building slab has been poured, and in particular can demonstrate presence of traps and gulleys, uphill slopes, and presence of construction materials not properly removed or flushed from systems before such issues cause damage or repair issues become problematic.*

**E. Final Drainage System Testing:** Final testing shall be specified for each sanitary, lab/ARF, and grease waste drainage/vent system after all fixtures have been set and all traps filled with water. A U-tube manometer shall be inserted through a trap after plugging the building sewer and vent stacks and an air pressure of 250 Pa (1 in. w.g.) shall be applied through the trap seal and shall hold for fifteen minutes without loss of pressure. Upon completion, all vent stack plugs shall be confirmed to have been removed. Hidden leaks in occupied facilities shall be located through means that do not disrupt research/ARF areas (e.g., approved olfactory, sonar, etc.).

*Rationale: Final testing ensures systems are gas-tight and that all traps are properly set and effective to prevent escape of gases into the facility.*

# Section 8.5

## Natural Gas/Fuel Gas Systems

---

### Contents

8.5.0 Introduction

8.5.1 Systems Approach

8.5.2 General Requirements

8.5.3 Testing and Purge Requirements

## 8.5.0 Introduction

This section addresses the installation of fuel gas systems provided as a utility service to laboratory and animal research facilities (ARF), and fuel gas systems for other applications including, but not limited to food service and mechanical equipment applications. Additional applications of fuel gas within NIH facilities shall be approved by ORF and DFM.

## 8.5.1 Systems Approach

Natural gas is distributed on campus through an underground distribution network to each facility requiring fuel gas service. Gas service shall be independent for each building requiring service.

Low pressure gas shall be independently distributed (from the point of the exterior service entrance) to lab areas per program requirements. Independent gas shall be provided to central food service areas and a third independent fuel gas supply shall serve mechanical equipment where fuel-gas operated equipment is required. Buildings at the NIH Bethesda Campus do not typically have gas-fired mechanical equipment.

The provision of fuel gas to lab spaces is not automatically required for distribution to lab areas and such distribution shall be based upon need and preference of the program to accommodate research or flexibility.

*Rationale: The use of fuel gas is often not required in laboratories with the use of modern equipment and techniques. However, where such need is required by the program, piped natural gas is to be provided. Separation of systems is to minimize potential for disruption and safety issues.*

## 8.5.2 General Requirements

**A. Codes/Standards:** Natural gas systems shall be designed per NFPA Standard 54/ANSI Z-223.1, National Fuel Gas Code, and the requirements of the serving gas purveyor (at the NIH Bethesda Campus, Washington Gas). Propane/liquefied petroleum gas

(LPG) systems shall be designed in accordance with NFPA-58 and DFM requirements.

**B. Fuel Type:** Natural gas shall be utilized as the primary fuel gas source in NIH facilities. LPG may be used for remote buildings when life cycle costing justifies its installation over natural gas, and subject to approval of ORF and DFM for the application, and installation, including but not limited to location of tanks, vaporizers (where required), and equipment.

*Rationale: Natural gas is readily available on-campus in Bethesda, but is not available at all off-campus locations. Use of natural gas is preferred over liquefied petroleum gas to minimize safety and operational issues.*

**C. Storage of Fuel Gas:** Interior building storage of compressed fuel gas or LPG is not permitted except as specifically required by the laboratory where connection to the building natural gas system is not available at the project site or, where approved. Fuel gas storage arrangement and locations shall be subject to ORF and DFM approval and must conform to the requirements of [Section 12.3 Compressed Gas and Cryogenic Systems](#), and any additional DFM requirements.

**D. Gas Service Entrance:** Gas service shall enter buildings above grade and without crossing under buildings. An approved, eccentric type, non-lubricated, plug-type main gas service shut-off valve and union or flange shall be provided at the exterior service riser. Fuel gas shall enter each building from a single service point, unless approved by ORF and DFM. The exterior service riser shall split to separate mains into the facility to serve each major function (lab, foodservice, and mechanical). A corrosion resistant anodeless riser shall be provided.

*Rationale: This is to address disruptions and safe maintenance isolation issues, to minimize potential for fuel gas leaks and corrosion of fuel gas piping and gas service transitions, and to ensure appropriate access of service entrances.*

**E. Gas Distribution Pressure, Flow, and Diversity:** Fuel gas-piping distribution systems that serve laboratories shall be low-pressure systems. The natural gas piping system shall be designed to provide 0.03–0.04 L/s (4–5 CFH) at each laboratory outlet at a pressure



of approximately 1,750 Pa (7 in. w.g.). For fixed laboratory equipment, the volume flow rate and pressure required shall be determined from the manufacturer's input ratings. Diversity may be applied for laboratory turret outlets if the diversity is safely established; however, equipment shall be considered at 100% use factor. Where LPG systems are approved, the pressure shall be reduced prior to entering the building to 2,740 Pa (11 in. w.g.), except that pressures up to 1,379 Pa (5.5 in. w.g.) may be used to serve major mechanical equipment areas where approved by ORF, DFM, and in conformance with NFPA-58.

Welded medium pressure natural gas distribution systems at pressures up to 35 kPa (5 psi) may be used to serve the inlet pressure regulator in food service and mechanical areas, where justified by the gas load and installed in conformance with NFPA-54 and serving gas supplier requirements, including provision of proper over-pressure protection, except that natural gas service to food service areas shall not exceed 14 kPa (2 psi) unless specifically required for individual equipment, or approved. No diversity shall be applied to food service equipment.

Primary building equipment loads (such as for building mechanical equipment) shall not be diversified unless a control means is provided to preclude simultaneous operation and prior approval of NIH is obtained.

*Rationale: The design criteria for flow and pressure are established to promote flexibility of the gas system to support a range of burners and equipment without excessive need for gas-pressure regulators and to minimize risks associated with occurrence of a leak. Diversification of primary equipment loads is not permitted where such equipment could potentially be operated simultaneously.*

**F. System Sizing:** The design pressure loss in the gas piping system shall be such that the supply pressure at any piece of equipment is greater than the minimum pressure required for proper equipment operation. A maximum pressure drop of 75 Pa (0.3 in. w.g.) during periods of maximum design flow shall be used for sizing low-pressure gas installations. Pressure drop in medium pressure systems (including any systems

operating at or above 6.89 kPa (1 psi) shall not exceed 10% of the design distribution pressure at maximum design flow demand.

*Rationale: These requirements are to ensure required operating pressures are provided consistently and safely during peak operating conditions.*

**G. Shut-Off Valve Type:** Shut-off valves shall be specifically listed for the appropriate fuel gas application and for use at the system operating pressure. All interior gas valves shall be actuated without requiring the use of tools.

**H. Emergency Isolation Valves:** Each laboratory floor shall have an isolation valve that is quickly accessible for emergency shut-off, located through consultation with the DFM, to permit a rapid emergency isolation of an individual floor of each building wing. The valve shall be located behind a wall cabinet box (zone valve box) with an accessible clear-glass door or emergency window to prevent nuisance activation. The valve shall be labeled:

*“Emergency fuel gas shut-off”*

A permanently attached tag shall be provided inside the valve box stating:

*“If valve is shut, contact NIH DFM prior to reopening.”*

An automatic actuated valve(s) may be used in lieu of manual operation. If the emergency shut-off valve is of actuated type, it shall be of a stored energy type and shall preclude inadvertent shutdown due to unintended loss of power source or air supply, shall be at least Class 1, Division 2 if electrical or shall be pneumatic type, and shall require manual operation to reopen. The valve activator shall be located in a wall cabinet box with an accessible clear-glass door or emergency window.

Provision of this emergency isolation valve is required in addition to an accessible, dedicated valve to isolate all lab gas service, an isolation valve for food service, and an isolation valve for general mechanical service; each located at the building service entrance and appropriately labeled. Additionally, a whole building isolation valve shall be provided at the service entrance.

***Rationale:** Emergency shut-off gas valves that automatically reopen could induce hazards if they were to reopen prior to safe conditions (all valves closed) having been verified. Nuisance tripping of a gas valve could similarly cause unsafe conditions. Pneumatic actuated normally open valves fed from a reliable compressed air supply can be utilized. The use of actuated valves may be beneficial in large facilities such that gas source may be readily isolated from each access point (typically near beginning or end of primary egress corridor). In emergency conditions, the fire department must be able to isolate each major service, or the whole building quickly and without entering program areas.*

**I. User Accessible Shut-Off Valves:** A user-accessible shut-off valve is required for each piece of fixed equipment. Additional shut-offs are not required for lab turretts (with the exception of those provided for equipment such as fume hoods) as these shall be served by the shut-off valve serving the laboratory.

A lever-handle fuel gas shut-off valve shall be provided upstream of each cooking line, in addition to the required commercial food service equipment automatic gas shut-offs associated with fire safety and individual equipment shut-offs.

**J. Food Service Auto Gas Shut-off:** Automatic gas shut-off arrangements for food service area fire suppression systems shall be provided in accordance with NFPA-54, NFPA-58, and NFPA-96 and UL-300. Automatic shut-off valves shall require a manual reset. An additional manual activation means in the path of egress shall be provided in accordance with NFPA-96.

**K. Mechanical Room Gas Train and Auto Gas Shut-off:** For pressure vessels, comply with UL and ASME CSD-1 at a minimum, utilizing control devices listed by a nationally recognized testing agency. For capacities over 2,500 MBH, compliance with FM or IRI is additionally required. For applications over 5,000 MBH, comply with IRI requirements unless otherwise approved or directed by the ORF and DFM. Non-pressure vessel applications shall comply with NFPA, ANSI, UL and FM requirements at a minimum and as applicable for the gas train application.

**L. Connectors:** Whenever equipment is on wheels or intended to be movable for regular cleaning or usage, the gas connection shall be made with a UL/AGA listed, ANSI Z83 constructed epoxy-coated stainless steel commercial-type gas connectors that are specifically designed for movable equipment applications and includes a quick disconnect with integral shut-off and a properly assembled restraining device. A user-accessible shut-off valve shall be provided. Gas connectors for food service areas shall meet NSF requirements. Residential grade corrugated steel connectors are not acceptable.

***Rationale:** These requirements are intended to provide a safe means of accommodating movable equipment without elevated risk of gas leakage or line breakage.*

**M. Installation Requirements:** Gas connections to laboratory equipment and fixed equipment shall be hard piped, and unions shall not be permitted in concealed, unventilated spaces, including above ceilings. The final gas connection below the ceiling to laboratory fume hoods may be made with ASTM A539 welded steel tubing approved for fuel gas lines or hard connected with iron piping. Compression fittings shall not be utilized at any point in a fuel gas system. Couplings used in fuel gas systems shall include appropriate thread stops and proper National Pipe Thread (NPT) taper. Factory-furnished couplings at the end of threaded steel pipes that protect pipe threads shall not be used in the piping system in lieu of proper fittings and the A/E shall specify these to be discarded. Underground fuel gas shall be installed in conformance with 49 CFR Part 192 subpart G, subpart H, as well as ASTM D2774.

Hard piping of equipment is not utilized where there are seismic considerations or where equipment must be movable.

***Rationale:** This installation and joint connections requirement is intended to reduce the high incidence of leakage at these joint types. Compression fittings are not designed for fuel gas application. Properly installed flexible connectors protect from breakage/leaks in seismic events; however, they must be selected so as not to pose a potential leak risk to the facility over the service life.*

**N. Distribution Arrangement:** Services to each floor of a building wing shall be connected to respective supply risers, independent of other floors. Refer to requirements of [Section 8.1 Plumbing General Requirements](#). Gas piping shall not route through electrical rooms or other potential sources of combustion, hazardous or critical spaces, or where subject to potential mechanical damage. Horizontal gas piping shall be graded to slope to drain towards the service entrance and risers at a slope of at least 5 mm (0.1875 in.) per 5 m (16 ft.).

*Rationale: These requirements are intended to preclude potential disruptions, maintain continuity of service and protect components from contamination.*

**O. Pressure Regulators:** Gas pressure regulators shall be vented to the outside, terminating at code approved locations, sufficiently elevated, turned down and designed to prevent blockage. Pressure regulators without external vents shall not be utilized with the exception of low pressure natural gas appliance regulators (1750 Pa [7 in. w.g.] or less) located at terminal outlets for single appliances where such regulators are approved by the serving gas supplier and in conformance with applicable codes and standards, and provided the area of the installation is sufficiently ventilated to address the flow through the vent limiter in the event of a diaphragm failure. Vent limiters shall not be used outdoors.

*Rationale: These provisions are to minimize risks associated with regulator failures and maintenance issues.*

**P. Sanitary Areas:** Gas piping in food service areas and other spaces which must be readily cleanable shall stand off from the wall at least 25 mm (1 in.), utilizing corrosion resistant sanitary stand-off clamps (not strut material), and shall be arranged to facilitate sanitation and avoid concealed fouling spaces.

**Q. Biological Safety Cabinets (BSC):** Fuel gas shall not be piped to biological safety cabinets.

*Rationale: Pressurized gas, heat, and flames may disrupt intended air flow patterns and sterile fields, damage HEPA filters, and (in the*

*case of recirculating cabinets could also result in potentially explosive gas buildup) thereby compromising the safe and effective operation of BSCs. LPG is especially hazardous. Alternatives techniques are available.*

**R. Grounding Electrode:** Fuel gas piping systems shall be electrically bonded to a grounding electrode in accordance with NFPA-70 and NFPA-54.

**S. Valve and Component Listings:** Valves and specialty components shall be specifically listed for the appropriate flammable gas/fluid application and for use at the system operating pressure and application conditions. Gas valves shall be listed to UL, AGA, CSA International, and ASME standards (as applicable) in consideration of system operating pressure, type of fuel gas, and installation location. Valves at gas service riser shall be wrench-operated. Where plug type valves are utilized, they shall be non-lubricated type only, approved for fuel gas service.

*Rationale: Lubricated plug valves, as often utilized in fuel gas systems, require routine maintenance which if not adequately performed may not operate when required.*

**T. Fuel Gas Storage Tanks and Supply Systems (LPG):** Tanks and supply systems shall be ASME code construction and shall be safely distanced from buildings and sources of ignition, including termination of relief valves.

### 8.5.3 Testing and Purge Requirements

**A. Post-Installation Blow-Down:** Systems shall be blown clean free of debris and residual oil with clean dry nitrogen or dried compressed air prior to installation of any regulators, controls, or hook-up to any equipment.

**B. Testing:** Testing shall be performed to ensure no cross-connections are present. Fuel gas piping shall be tested in accordance with NFPA-54 (or NFPA-58 as applicable) based on the total piping system volume,

except that in no case shall the test pressure be less than 420 kPa (60 psig) for an 8 hour test period. Every connection shall be tested, and procedures to isolate equipment from test pressure shall be strictly followed. Only final connections to equipment (downstream of any appliance regulators) may be tested with non-corrosive manufactured gas leak detection solution or electronic leak detectors in lieu of elevated pressure tests. The use of homemade soap solutions is unacceptable. Fuel gas systems shall be tested after all gas turrets have been installed, with a test pressure of at least 420 kPa (60 psig) for at least 4 hours, upon verification of compatibility of test pressure with the installed gas turrets. Control devices and components not designed for operation at the test pressure shall be isolated.

**C. Post-Installation Purge and Preactivation Leak Check:** Post installation and system modification gas system purging practices shall be specified to strictly conform to current edition of NFPA-54/ANSI Z223.1. Compliance with “Suggested Methods of Checking for Leakage” as indicated in Annex C of NFPA-54 is mandatory immediately prior to restoring a fuel gas service; regardless of pressure or leak test results.

*Rationale: Extent of gas system testing varies by codes, standards, and local ordinances; however, for NIH projects, all gas connections shall be tested to preclude leakage and safe purge practices are mandatory. The final leak-check process immediately prior to activation ensures system is tight and all outlet openings are closed.*

# Section 8.6

## BSL-3 and ABSL-3 Biocontainment

---

### Contents

- 8.6.0 Introduction
- 8.6.1 BSL-3 General Plumbing Requirements
- 8.6.2 Water Systems Serving BSL-3
- 8.6.3 High Purity Water Serving BSL-3
- 8.6.4 Animal Drinking Water Systems Serving ABSL-3
- 8.6.5 Vacuum Systems Serving BSL-3 Laboratories
- 8.6.6 Compressed Gases Serving BSL-3
- 8.6.7 Veterinary Medical Gas Systems
- 8.6.8 Critical Compressed Air/Control Air Serving BSL-3
- 8.6.9 Waste and Vent Systems Serving BSL-3
  - 8.6.9.1 General Requirements
  - 8.6.9.2 Effluent Decontamination, Waste Treatment, and Biowaste for BSL-3
- 8.6.10 Liquid Nitrogen and Cryogenic Fluids Serving BSL-3 Laboratories
- 8.6.11 Plumbing Fixtures Serving BSL-3 Laboratories
  - 8.6.11.1 Faucets
  - 8.6.11.2 Showers
  - 8.6.11.3 Water Closets
  - 8.6.11.4 Sinks/Lavatories
  - 8.6.11.5 Mop Sinks
  - 8.6.11.6 Fixture Trap and Supply Insulation Kits
  - 8.6.11.7 Floor Drains/Floor Sinks/Drain Troughs
  - 8.6.11.8 Emergency Fixtures
- 8.6.12 Special Materials and Equipment
  - 8.6.12.1 HEPA Filters/In-Line Filters
  - 8.6.12.2 Gas-tight Check Valves
  - 8.6.12.3 BSL-3 Vacuum Valves
- 8.6.13 BSL-3 Plumbing Requirements for Special Applications
- 8.6.14 Containment Autoclave Chamber Pressure Relief
- 8.6.15 Special Testing and Inspection Requirements
  - 8.6.15.1 All Piping Systems
  - 8.6.15.2 Waste and Venting Systems
  - 8.6.15.3 Plumbing Fixtures and Equipment
  - 8.6.15.4 HEPA/In-line Filters
  - 8.6.15.5 Critical Compressed Air



## 8.6.0 Introduction

This section addresses requirements unique to BSL-3/ABSL-3 containment areas. It is not all-inclusive as design also needs to comply with other sections and conditions of the risk assessment.

Where provisions of this section directly contradict requirements indicated in other parts of [Chapter 8](#) or [Chapter 12](#), the requirements of this section apply.

Except where indicated, BSL-3 requirements apply to ABSL-3 facilities in addition to any special requirements for the particular animal facility under consideration.

*Rationale: These requirements are to minimize potential for cross-contamination from high containment areas to other spaces (whether during normal operation or as associated with maintenance activities), as well as to minimize disruptions to research and the need for personnel to enter the containment space to perform maintenance. This is not intended to prevent the use of common building services that are subsequently appropriately isolated for each level of containment prior to serving such space.*

## 8.6.1 BSL-3 General Plumbing Requirements

**A. Common Engineering Requirements:** Refer to [1.15.5 Supplemental Technical Requirements for High Containment Facilities](#) for additional related design requirements.

**B. Primary Containment Equipment:** Plumbing services shall not be piped directly to any primary containment device without approval of the NIH, in accordance with the risk assessment, and provision of an approved, redundant backflow protection arrangement to isolate the connection from any other system.

**C. Piping Location and Cross-Contamination:** Cross-contamination protection (e.g., between suites or other spaces) may be required to protect research or facilitate service. Protection shall be provided in accordance with the risk assessment, including but not limited to backflow protection, filters, and segregation of services. There should be no open connections from piping systems within containment. Piping systems serving functions located on the clean side of the containment barrier shall be located outside the containment barrier. Containment piping systems or other isolated systems serving BSL-3/ABSL-3 areas shall not serve across higher or lower bio-safety levels. Waste piping shall not be routed above food service, food storage, or surgical/aseptic areas.

**D. Isolation Valves:** Each pressurized piping penetration from outside the barrier into containment shall be provided with a shut-off valve located outside the containment barrier serving only the BSL-3 area(s). Each equipment connection shall include a dedicated isolation valve. Fire-sprinkler piping need not be provided with a shut-off valve at each penetration; however, the sprinkler zone serving BSL-3 should be capable of independent isolation.

**E. Radioactive Fluids and Waste:** Radioactive wastes are handled in accordance with the radioactive waste handling program and shall not be removed or handled as a piped service. Specific provisions will depend upon the application and individual isotope. Where such conditions are encountered, a meeting with the NIH is required for specific direction to ensure compliance with all regulations and safe handling and disposal requirements.

## 8.6.2 Water Systems Serving BSL-3

**A. Isolation:** Water supplies to BSL-3 spaces shall be isolated from other functions with an approved backflow preventer (BFP) installed outside containment prior to serving BSL-3 areas. A single device may be provided for each individual penetration, or parallel devices arranged to provide N + 1 redundancy may be utilized to serve multiple suites.

Where the supply is from the building general laboratory water system, an ASSE 1015 (manufactured double-check valve assembly) shall be utilized for containment



barrier isolation. Where supply is direct from building potable water, an ASSE 1013 (reduced pressure principal) device is required. The drain from an ASSE 1013 device shall spill through an air gap to a floor drain or other suitable indirect waste receptor located outside containment.

Backflow protection is required at points of use consistent with requirements of [Section 8.3 Water Systems](#) (including but not limited to vacuum breaker spouts at faucets where required by risk assessment), showers with hose sprays, as well as protection at equipment connections).

No special requirements are warranted regarding the discharge from a backflow preventer (including ASSE 1013 devices) serving general BSL-3/ABSL-3 areas.

*Rationale: The use of ASSE 1015 devices in lab water systems recognizes the presence of an upstream ASSE 1013 device to protect potable water supplies, and can be advantageous due to low-pressure drop, adequate hazard protection for the application when applied in accordance with DRM requirements, and avoids the need to accommodate device drainage.*

**B. Distribution Arrangement/Separation/Hot Water Temperature Maintenance:** Downstream of the isolation backflow preventers, distribution shall only serve outlets within containment and water shall not be circulated back upstream of the containment barrier isolation backflow preventer. Hot water shall be immediately available at use points, with delays to the most remote outlets not exceeding ~15–25 seconds. In some cases the use of auxiliary heat source (e.g., a local booster heater with thermostatic control) may be required for temperature maintenance. The use of local heat tracing downstream of the backflow preventer may be permitted provided the system design minimizes the quantity of required heat tracing, tracing is accessible for replacement, and is of industrial grade.

*Rationale: Circulation back to the upstream side of backflow preventers defeats the protection afforded by the device.*

**C. Unprotected Potable Water:** Unprotected potable water shall not be extended into containment. Outlets requiring potable supply direct from the domestic potable water system (e.g., emergency eyewash, showers, and toilet room/shower fixtures located in containment) shall be isolated from other functions with an ASSE 1013 backflow preventer. The ASSE 1013 backflow preventer shall be located outside the containment barrier. An ASSE 1015 backflow preventer is adequate for serving only toilet room/shower-out room fixtures without hose-supplied outlets. Appropriate vacuum breakers (or air gaps) are required at potable water outlets, including showers with hose sprays.

*Rationale: All water supplies shall be protected from potential backflow, which could include misapplication and inadvertent future cross connections. The risk of backflow from a toilet room is normally low.*

**D. High Hazard Connections:** Backflow preventers are required for connections to high hazard equipment and shall be of the type for the application, hazard, and located outside the containment barrier. Connections to tissue digesters, vacuum pumps, and other high hazard arrangements shall consist of at least an ASSE 1013 device if supplied from the lab water system (preferred) or an ASSE 1013 device and downstream ASSE 1015 device in series if connection must be made directly from potable water. An ASSE 1013 is the minimum required protection at high containment autoclaves. Where the design of equipment utilizes an internal code-compliant air gap or does not impose a back-pressure backflow condition, redundant in-line devices are not required and a single ASSE 1013 device is satisfactory. A below flood level rim air break is not equivalent. Potable water shall not be hard connected to a primary containment device. An ASSE 1015 devices shall be located immediately downstream of ASSE 1013 devices where necessary to protect from potentially contaminated relief discharge.

**E. Anterooms:** Water supply to anterooms at the containment barrier shall be supplied from the BSL-2 (general protected) lab water system. Where water supply is direct from potable water (rather than from lab water), an ASSE 1013 RPZ backflow preventer shall be provided prior to serving the anteroom.

**F. Water Treatment Equipment:** Where softeners or other water conditioning devices are required, they shall be located upstream of backflow preventers, outside containment.

### 8.6.3 High Purity Water Serving BSL-3

**A. System Independence:** Purified water systems serving BSL-3 areas shall be completely independent of any clinical systems or other applications requiring sterile or pharmaceutical grade water supplies.

*Rationale: This requirement is to ensure that sterile or special quality water supplies are not compromised.*

**B. Required Approach:** Point of use purified water production units, fed directly from the BSL-3 lab water and selected for the on-site water chemistry to deliver required water quality(s) is the preferred method of providing high purity water within BSL-3 spaces, and shall be utilized unless approved by NIH. Such units shall include an ultrafilter or microfilter at the point of dispense.

*Rationale: Point of use production equipment (e.g., polishing systems designed for use with tap water supplies by inclusion of the Reverse Osmosis (RO) or distillation process) is well suited for these applications and typically most cost-effective for the limited quantities of dispense points; and properly selected and maintained can provide all required water qualities. This approach is preferred as it avoids circulation of services from within the suite and facilitates accommodation of backflow protection for water supplies without inducing an arrangement of dead-legs or other microbial control issues.*

**C. Centralized High Purity Water Systems:** A life cycle cost analysis should be performed in determining the use of central vs. point of use systems, inclusive of periodic maintenance, consumables, and facility disruption.

Centralized high purity systems including RO and other purified systems (i.e., systems that serve multiple outlets) shall be subject to justification and approval, and where provided shall be in accordance with the following requirements and [Section 12.1 High Purity Water Systems](#), including water quality.

*Rationale: Maintaining quality purified water requires constant recirculation from the point of production directly to each use point. Backflow preventers, filters, and segregation requirements as well as the varying uses of these systems can pose risks of contamination and high maintenance. Though satisfactory arrangements are possible, they are often not cost-effective except for large facilities; especially since polishers are required regardless to produce ultrapure water grades.*

**D. Central System Purified Water System Arrangement:** The RO source water (whether from a central or local system) shall supply a dedicated atmospheric pressure maintained and vented storage tank configured to ensure a break tank (separation) function between the tank contents/associated distribution system for BSL-3 areas and the supply fill.

The fill control shall be through an actuated zero-static valve arranged to maintain constant circulation for the supply system to preclude dead-legs from central RO supply, except circulation is not required where the source of makeup water to the tank is directly from a dedicated (independent) adjacent RO membrane and associated high pressure pump. The supply (fill) connection to the tank serving high containment areas shall be sufficiently above the top of the tank and high alarm level to avoid backflow, and the tank shall include redundant high level control valves with high water alarm. The size and placement of the filtered vent shall be sufficient to maintain atmospheric conditions in the tank under all conditions, to maintain an air break with the supply fill, and arranged to prevent blocking of hydrophobic vent filter media without stressing the rupture disk.

The tank shall be designed and constructed to be gas-tight and fully sealed (other than the filtered vents), and protected with an appropriate low pressure sanitary rupture disk with burst indicator. The burst disk placement and selection shall be below the level of water head

required to submerge the supply (fill) system, and below tank maximum pressure rating; but should be as high as possible to minimize maintenance or premature disk rupture. The rupture disk shall be pressure or pressure and vacuum type (as appropriate to tank and distribution configuration).

The tank shall not incorporate threaded manways or other loosely sealed arrangements and shall be continuously provided with electrolytic type ozonation with UV destruct prior to distribution, circulation pumps, and central 0.1µm hydrophilic membrane microfiltration, as outlined in [Section 12.1 High Purity Water Systems](#). A dedicated distribution/circulation loop, serving only BSL-3 shall be provided, with the forced circulation return back to the tank, and shall include a pressure sustaining valve arranged to ensure that pressure within the loop in no case drops below 138 kPa (20 psig). Where possible, the tank and distribution piping should be above the elevation of the use outlets.

**E. Central System Distribution Arrangement and Isolation Valves:** An isolating valve shall be provided on the discharge of the production equipment and main return, located at the production equipment, to facilitate positive system closure where necessary for maintenance. Isolation valves shall be provided for each lab suite. Where more than one system zone is provided, the individual suites shall connect to a direct return or reverse return arrangement. A single serpentine loop may be applied to serve each individual suite.

**F. No Circulation Between Lab Suites:** Purified water systems shall not circulate between outlets from one lab suite into another. For this purpose, suites segregation shall correspond with HVAC system filter zoning or as programmed and approved in accordance with the risk assessment.

**G. Point of Use Backflow Protection:** Within containment, non-return valves/backflow preventers or microfilters of a suitable type as identified in [Section 12.1 High Purity Water Systems](#) shall be provided at points of dispense. They shall be located downstream of the zero-static loop faucet control valve for dispense of general RO water, and at the polisher connection where polishers are provided for dispense of ultrapure water. Manufactured polishers with RO, microfilters, or ultrafilters do not require additional point of use devices.

**H. Recirculation of Fluids:** Recirculation of fluids downstream of any backflow preventers back into the supply side is prohibited. Except as provided in this section, recirculation of fluids back outside the containment barrier is not acceptable.

*Rationale: These requirements are to maintain high quality purified water for these spaces while controlling potential cross-contamination from one space to another through water systems due to chemical or biological contaminants. Maintaining system directional flow and system pressure is necessary to prevent back-siphonage-related backflow. Break tanks provide a separation function, and low TOC is a key parameter to water quality, particle, and microbial control. Rupture disks maintain sealed systems; hydrophilic filters maintain system water quality; local backflow preventers and pressure control provide protection for the loop. Ozonation ensures clean uncontaminated supply at the tank and allows routine system sanitations to occur without requiring workers to enter the containment suites.*

## 8.6.4 Animal Drinking Water Systems Serving ABSL-3

**A. System Type:** The use of bottled or prepackaged water versus piped automated drinking water systems shall be evaluated through the risk assessment and consultation with NIH. Detailed design documents for animal drinking water (ADW) systems shall be submitted for review and approval during project design.

*Rationale: The method of supply can have safety, cross-contamination, and operational impacts and the preferred approach can vary with animal type and housing.*

**B. Water Supply:** Animal drinking water serving BSL-3 shall be completely independent of other containment levels. Water supply serving animal drinking

water treatment and distribution systems shall be taken directly from building potable water and the supply to the BSL-3 area system shall be isolated from all other systems with an ASSE 1013 backflow preventer located outside the containment barrier. ASSE 1015 double-check valve assemblies may be provided downstream of ASSE 1013 devices to mitigate potential of contaminated relief-valve discharge outside of containment (if required by the risk assessment). Once distribution systems have entered high containment, downstream segments of the system shall not be piped back out of containment and shall not have any openings (including tanks or drainage points) that are located outside of the containment barrier. At a minimum, an ASSE 1015 device shall be located on the main ADW pipeline (typically upstream of any flushing or PRV stations), shall be constructed of stainless steel, and shall be located to isolate the pressurized ADW water system from openings outside containment.

**C. Distribution:** Where piped systems are provided, only non-circulated systems (automatic flushing-type animal drinking water systems) shall be used, and maintenance of an approved residual disinfectant throughout the system (typically chlorination at up to 4 mg/L) is required. Flushing lines from the animal drinking water distribution system shall terminate with a fixed air gap to a normally used drain within the containment barrier, and flushing lines for individual rooms shall discharge within the same room served. Drain terminations shall be arranged to minimize splashing or displacement.

*Rationale: Recirculated animal drinking water arrangements, and piping in and out of containment areas are not used within BSL-3 due to possible cross-contamination and safety risks.*

**D. Program Area Cross-Contamination Control:** Requirements for cross-contamination control between program areas shall be evaluated in the design and determined through consultation with the program management and risk assessment. ASSE 1015 stainless steel backflow preventers may be used within the distribution system where required for cross-contamination issues that do not pose a high risk personnel safety concern, and where provided shall be upstream

(on the high pressure side) of pressure-reducing/flush stations. Approved microfilters in conformance with [Section 12.2 Animal Drinking Water Systems](#) may be used where justified, and where applied shall be located within containment and arranged to facilitate routine replacement, and both filters and backflow preventers shall be used only with chlorinated ADW systems and preapproval of program management to ensure sufficient SOP's for routine maintenance/replacement.

*Rationale: Cross-contamination protection may be requested between spaces or suites working with different agents or under different programs. BFP's typically require annual testing. Filters typically require replacement at least quarterly. Unnecessary filters require additional maintenance and can compromise water quality.*

**E. Equipment Location:** Production systems (RO, acidification, chlorination, etc.) shall be located outside the containment barrier in program-controlled or approved secure space. Refer to [Section 12.2 Animal Drinking Water Systems](#) for production system requirements. Drains for the production system shall discharge at the location of the equipment.

Where any controls are located inside containment, components shall be constructed or sealed to permit and withstand fumigation. System controls or valving shall permit flushing control valves to be individually manually activated or disabled.

## 8.6.5 Vacuum Systems Serving BSL-3 Laboratories

**A. Disinfectant Traps/Hydrophobic HEPA Filters:** The use of disinfectant traps and hydrophobic filters are required at each point of use, including biological safety cabinets and aerosol chambers. Filters utilized shall be at least HEPA efficiency for liquid and gas streams; and permanent type pipe-line filters should be sterilizing grade for repeated usage, typically fluoropolymer (PTFE or PVDF) hydrophobic membrane type, or as otherwise approved by NIH.



*Rationale: Disinfectant traps and approved in-line filters protect piping, equipment, and exhaust streams from contamination. Use of filters is to provide microbial protection and minimize potential of drawing liquids into the vacuum system. Appropriate sterilizing grade filter and housing assemblies (unlike point of use disposable style filters) are designed for repeated use and are typically validated for higher efficacy for both liquid and gas streams.*

#### **B. Materials Compatibility and Decontamination:**

Vacuum system equipment, piping, seals, and components shall be selected and arranged to be compatible with the anticipated fumigation method and liquid disinfectant trap fluids as determined by the risk assessment.

*Rationale: All components must be arranged to facilitate an approved means of decontamination to facilitate service and disposal. Portable vacuum pumps and HEPA filters may be autoclaved and repaired or disposed.*

**C. System Approach:** Vacuum may be produced at the point of use through portable/in-lab vacuum pumps of corrosion-resistant construction. As an alternative, dedicated central systems may be utilized where justified by outlet quantity, preference of the program authorities, and consistent with requirements of the risk assessment.

**D. Point of Use:** Point of use vacuum should be of the double-diaphragm type, selected to be low noise, suitable for corrosive vapors or aerosol, leak tight design, and with no potentially contaminated fluids (oils etc.) that require service or disposal. Such pumps may be cost-effectively decontaminated, discarded, and replaced upon malfunction. Pumps shall be selected with appropriate elastomers compatible with disinfectant traps and fumigation chemicals. Equipment shall be coordinated with the risk assessment. Units are connected to a user-provided point of use disinfectant trap and liquid separator, and a user provided single or double (in series) vacuum line hydrophobic filter of at least HEPA or sterilizing grade. Exhaust from point of use portable vacuum pumps may be directed to the outside through discharge into a containment device or exhaust serving the space, or discharged within the containment space where permitted by the risk assessment, as approved by DOHS.

*Rationale: Point of use vacuum can be cost effective, simple, and safe where properly selected and configured. Such arrangements offer the advantage of user control and responsibility, with no piped service leaving the space.*

**E. Central Systems:** Central systems may be used for large applications in accordance with the risk assessment, subject to approval and conformance with the following:

1. **Location and Independence:** The location of the system shall be in accordance with the risk assessment and approved by DOHS and ORF. Where central systems are selected, they shall be dedicated to the BSL-3 lab and shall not serve other areas, and shall be located near to the containment space. Central vacuum pumps should be located in a negatively pressurized room (negative to adjacent spaces).
2. **Decontamination:** Procedures: SOPs shall be developed, submitted, and approved for the pre-service decontamination method for systems and equipment.
3. **Disinfectant Trap/Liquid Separator/Filters:** Arrangement of traps, separators, and filters shall be as described above. A second filter of permanent type shall be located outside containment as close as possible to the barrier penetration, but must be upstream of the vacuum pump or other equipment requiring opening for routine maintenance and as approved by ORF and DOHS; and shall be permanent housing in-line (not disposable) type.

**F. Filter Decontamination and Validation:** Wherever permanent-type filters are applied, they shall be arranged to facilitate decontamination and required validation methods. Disposable (point of use) filters shall be subject to operational SOP's for quality control, decontamination and disposal. The decontamination and validation method shall be planned in advance to ensure an acceptable configuration. Methods of validating filters will typically include forward-flow-diffusion testing, water intrusion, pressure hold, or in some cases, multipoint bubble-point testing, and is required regardless if filters are certified as integrity tested.

*Rationale: These requirements are to protect the system from contamination. The second filter (in series) provides protection for the piping system and equipment in the event of improper trapping or a damaged or improper filter at the point of use, and to ensure effective retention that may include a potential liquid slug with a high bioload in the event of a failed or misapplied primary filter. Where located just outside the containment barrier, it provides assurance for the facility staff of presence of protection.*

**G. Effluent Discharge/Liquid Separator:** The primary liquid separator (located downstream of the disinfectant trap) shall be selected to facilitate autoclaving of entrapped liquid and pre-opening decontamination or treatment and disposal as determined appropriate in accordance with the risk assessment. All liquid separators/receivers shall be arranged to facilitate decontamination; and if located outside containment they shall be fully sealed, shall not include filters, mechanical devices, or other items requiring routine maintenance or opening of the vessel or exposure to potential contamination. Discharge from lab vacuum systems for BSL-3 spaces constructed per the DRM shall discharge to the sanitary system. Refer to [Section 12.4 Laboratory Vacuum Systems](#).

*Rationale: Liquid separators protect from ingestion of fluids, such as some condensable vapors or other liquid from the use point or disinfectant trap and the separator minimizes potential of ingesting liquid. Due to use of upstream hydrophobic filters and required pump types, it is typically acceptable to pipe directly to the vacuum receiver. Connection of vacuum systems to biowaste systems can pose cross contamination risks.*

**H. Decontamination and System Openings:** Vacuum equipment shall be designed to accommodate decontamination. There should be no openings from the vacuum system within the building except those normally sealed, with restricted access, and arranged for qualified maintenance use through proper SOPs, and at approved locations per the risk assessment. Decontamination ports and manual drains shall be valved and capped.

*Rationale: The intent is to maintain a completely sealed vacuum collection system, from the initial point of ingestion within containment to the point of discharge directly to the sanitary sewer and above the roof. If contamination enters the vacuum equipment, such contamination liquids will be disposed through the sealed waste system, not requiring waste handling or exposure, and equipment may be readily decontaminated.*

**I. Isolation Valves/Decontamination Ports:** Isolation valves and decontamination ports shall be provided to allow decontamination of the tank, pump, any filters, appurtenances, and vacuum lines of the system, and to allow independent isolation and decontamination of the pump without decontaminating the entire building-collection system.

**J. Central Vacuum Pump Type:** Central vacuum pumps shall be in conformance with [Section 12.4 Laboratory Vacuum Systems](#), and shall be of corrosion-resistant construction suitable for disinfectant liquids, vapors, and fumigation chemicals and the method of decontaminating equipment in the event of an operational or equipment failure. Additional requirements:

The use of hermetically sealed canned motor or magnetic drive design may be selected to eliminate mechanical seals and associated leak paths. The need for such shall be determined based on risk assessment.

Seal liquid from liquid-ring vacuum pumps may be recirculated within the system only. Where process cooling liquid is utilized, the process cooling liquid shall be at a pressure of at least 10 psig above the pressure of any seal liquid within the vacuum system unless a double-wall heat exchanger is utilized.

Vacuum equipment that requires routine opening of the process parts of the system (e.g., more than once per year), including to change any fluids is not acceptable.

The use of vacuum equipment with disinfectant seal liquids shall require demonstration of temperature compatibility, replenishment frequency and method, and efficacy.



*Rationale: Although lab vacuum systems should be adequately protected by the upstream filtration, properly selected systems may be decontaminated by flooding with decontamination fluid.*

**K. Exhaust/Vent Lines:** Exhaust from the vacuum pump and vent lines for the hard piped receiver/liquid separator shall be separately piped above the roof at locations approved per the facility risk assessment and to prevent re-entrainment or exposure.

Vacuum exhaust may alternatively be hard connected to the BSL-3 exhaust system through series HEPA filters dedicated to this application, only to the clean side of the exhaust system (downstream of the HVAC HEPA filters), or through HEPA filters and dedicated exhaust fans with discharge arranged in accordance with other BSL-3 exhaust, provided such approaches are appropriately interlocked for proper operation and do not pose risk of contamination of the vacuum pump. Any connections between systems shall be made only in such manner as to safely prevent against unacceptable back-pressures and maintain sealed systems to the point of discharge.

**L. System Materials:** Upstream of the second (in series filter) piping systems shall be of Type 316L electro-polished stainless steel or other approved corrosion-resistant metal material of minimum wall thickness equivalent to Schedule 10, leak-tight, vibration-resistant design, and shall utilize automatic GTAW orbital welded permanently sealed connections (except for final equipment/outlet connections that may be threaded or metal gasket face seal [VCR type] joints). Copper tubing of at least Type L wall thickness with brazed joints (conducted with inert gas purge) may be utilized on the clean side (downstream) of the second filter where adequately protected from potential mechanical damage and compatible with disinfectants. Piping shall be reamed to restore full interior bore.

*Rationale: Materials and joining methods are to ensure system integrity and corrosion resistance, durability against breaching or damage, and suitability for effective decontamination; without particle traps or accumulation of particles that can impact filter performance.*

**M. Labeling/Signage:** Portions of vacuum systems upstream of the filters and as required per the risk assessment shall be provided with appropriate biohazard warning signage incorporated with the pipe-line identification label. Pipe-line nomenclature shall be system/application-specific. Equipment shall be labeled appropriately to alert maintenance staff to obtain clearance prior to service.

## 8.6.6 Compressed Gases Serving BSL-3

**A. General Provisions:** No special provisions are necessary for isolating pressurized gases into BSL-3 containment labs serving typical turrets located within the open lab. Such systems may be common with other BSL-2 compressed gas systems that do not serve animal clinical/medical gas applications, provided BSL-3 areas are zoned for independent service isolation.

*Rationale: Lab gas outlets in BSL-3 spaces typically do not represent significant hazard, primarily as outlets typically do not open into primary containment and systems are normally pressurized. Provision of additional backflow prevention should only be applied where required (e.g., where justified by the approved risk assessment).*

**B. Gas Cylinders/Shut-Off Valves:** Gas cylinders shall not be located inside containment spaces and shut-off valves should be provided for each penetration into containment to permit independent isolation of each service.

*Rationale: Compressed gas cylinder systems require maintenance and routine change-out – an activity best handled outside containment.*

**C. Specialty Equipment:** Pressurized gas systems shall not be connected to primary containment devices, including BSC's. CO<sub>2</sub> may be provided per the risk assessment. Only where pressurized gas services are necessary for required equipment operation or procedures in primary containment equipment (e.g., aerosol inhalation

chambers) may such services be provided, and subject to approval of the DOHS. In such cases, the service line shall have a backflow preventer check valve arrangement (per this section) at the point of use. Alternative backflow protection (e.g., an in-line sterilizing grade filter) may be provided in accordance with the risk assessment and as approved by the DOHS; however the method of decontamination for replacement and potential effect on gas quality shall be considered as relevant to the application. In all cases, 1/4 turn shut-off valves shall be provided immediately at equipment connections. Point of use filters shall be provided for aerosol chambers, incubators, and similar equipment where required for gas cleanliness or isolation per the risk assessment.

*Rationale: In some applications (such as inhalation/aerosolization chambers) compressed gases may be required as part of controlled processes. In such cases, additional control over fluid quality may be necessary for research integrity or containment. The provisions of this section are not intended to prevent the use of appropriate filters where such filters may be decontaminated and serviced or safely replaced.*

**D. Fuel Gas Service:** Provision of fuel gas service within containment is rarely necessary and shall be avoided. Where use of fuel gas cannot be avoided, justification and approval is required from the ORF, DOHS, and DFM. Accessible valving for emergency shut-off shall be provided to isolate the space at an approved egress location outside containment. Provision of fuel-burn-ing appliances that would require any type of venting arrangements are unacceptable.

*Rationale: Potential combustion sources within containment should be avoided. Fuel gas leaks or unclosed turrets may not be readily detected due to ventilation rates and use of PAPR's.*

## 8.6.7 Veterinary Medical Gas Systems

Veterinary Medical Gas Systems (VMGS) for BSL-3 (ABSL-3) areas shall be completely independent of

systems from areas outside BSL-3 containment, and protected from backflow or contamination with point of use filters selected in accordance with the risk assessment. Temporary point of use (i.e., transportable as needed) service may be provided. Where piped systems are provided, an upstream sterilizing grade, non-contaminating hydrophobic filter that is clean and approved for oxygen service, USP Class VI, and non-fiber releasing, or a gas-tight check valve that is clean and suitable for oxygen service shall be provided prior to penetrating the containment barrier. VMGS services for BSL-3 areas shall comply with [Section 12.5 Veterinary Medical Gas Systems for Animal Research Facilities](#).

The use of VMGSs may be accommodated by the use of portable gas cylinders dedicated for this purpose on an as-needed basis. The filters utilized may be user-provided disposable/sterilizable gas service filters provided for terminal units. If higher grade filter requirements are necessary they must be disposable/sterilizable between uses for cross-infection control and also shall be suitable for medical gas service.

*Rationale: The segregation of systems is necessary to prevent potential cross-contamination and maintain conformance with gas-quality assurances.*

**A. Alarm System Annunciation:** The alarms for VMGSs alarm panels shall alert to locations approved by the responsible high containment personnel, and the location and type of annunciation shall be as approved.

*Rationale: Alarms used in containment areas should provide warning, but should not startle personnel. Annunciation must reach persons able and authorized to respond.*

**B. Piped Veterinary Surgical Vacuum System Prohibitions:** Piped veterinary surgical vacuum systems shall not be utilized. Where vacuum is required, point of use (portable) equipment is required unless approved by ORF and DOHS. The arrangement of point of use filters and liquid separators and required stand-off supports and reinforcement provisions shall be addressed in designs for all configurations (including portable), and shall comply with the following:

1. Vacuum terminal connection and point of use autoclavable suction bottle/liquid separator (and bracket if on the wall, or coordinated if part of portable equipment)
2. Point of use disinfection trap (and bracket if on the wall), or placement and arrangement coordinated if part of portable equipment
3. In-line sterilizing grade filter, with decon and validation ports (and bracket)
4. For any case where a piped system is approved, a second sterilizing grade filter installed in series is required at the containment barrier and as approved by DOHS and system arrangements shall conform with both piped vacuum requirements for BSL-3 as well as veterinary medical gas requirements.

*Rationale: It is unacceptable to pipe infectious waste and blood out of containment. Filters provided with portable equipment and medical suction canisters are typically bacterial grade and not routinely validated or integrity tested for high containment applications.*

**C. Anesthetic Gas Scavenging:** Where all required procedures necessitating scavenging cannot be conducted within an approved ducted capture device, active scavenging shall be provided. Suitable disposable filters designed specifically for use with scavenging systems on the passive side of the air brake shall be provided upstream of the air brake (transfer hose side) as approved by the DOHS and the program veterinary anesthetist. Anesthetic gas scavenging shall be either:

1. Air-driven autonomous (self-contained) venturi type as per [Section 12.5 Veterinary Medical Gas Systems for Animal Research Facilities](#). The drive gas shall be located in the anteroom or other approved location as per the risk assessment, and shall include an in-line filter or gas-tight check valve at the (prior to entering) the containment barrier. The terminal unit exhaust shall be piped to an approved lab exhaust within the same containment suite, upstream of HVAC HEPA filters, as approved by the DOHS and the risk assessment. Indirect connections of the exhaust from

scavenging to the containment ventilation system is not permitted outside containment or outside of the suite where the terminal unit is located. Lab vacuum systems shall not be used for anesthetic scavenging. For all applications, the termination arrangement of the exhaust connection shall be designed to prevent escape of exhaust into the room. Application of an in-line HEPA filter may be required at the air brake per the risk assessment, and may be sterilizing grade if applied on the disposal side of the air brake and accounted for in system pressure loss; (or)

2. The use of self-contained point of use active systems (e.g., self-contained fan powered air brakes or systems with the extractor fan just upstream of the air brake within the same room at the point of use) may be applied for single outlets. The exhaust from such units shall be piped of approved hard pipe materials with permanently sealed joints to an approved non-recirculating capture device located within the same containment suite in accordance with the risk assessment; (or)
3. For applications with halogenated anesthetics only, the use of activated carbon type passive systems may be used with approval of the program veterinarian and DOHS, with autoclaving and disposal after each use.

*Rationale: As the use of in-line sterilizing filters, separators, and liquid disinfectant traps would interfere with permissible pressure limitations and other factors necessary for safe use of low vacuum active systems, along with avoidance of such vacuum leaving containment (including for high vacuum active systems), the venturi and self-contained air brake approach provide flexible and effective active scavenging without introducing contaminants not otherwise present in the space; while utilizing the ABSL-3 ventilation system serving the space for disposal. Even where central or point of use lab vacuum is present, combining systems to form high vacuum active scavenging can pose multiple risks to animals.*

## 8.6.8 Critical Compressed Air/Control Air Serving BSL-3

### A. Critical Control Air Definition and Application:

Critical control air is the complete system that provides the compressed air supply necessary for the operation or fail-safe condition of critical BSL-3/ABSL-3 HVAC, controls, or containment equipment (e.g., pneumatic dampers, air-powered sterilizer door gaskets, etc.).

**B. Reliability and Redundancy:** Air systems that serve critical containment controls and containment barrier components shall be arranged to prevent single point failures and shall be provided with complete redundancy from two fully independent remote sources. The primary air source shall be from a building laboratory or dedicated control air system arranged to provide N + 1 redundancy with compressors on building standby power. The secondary source shall be from a dedicated air compressor, receiver, emergency reserve nitrogen manifold, or equipment that is remotely located from the primary system and connected to prevent single point failure issues and arranged to prevent loss of required capacity. Upon failure of normal and emergency power, equipment malfunctions, or primary supply shut-off; sufficient air at adequate pressure shall be automatically available to operate and return critical controls to a safe position (including to maintain all sterilizer gasket seals); and the arrangement shall ensure that the required air supply will not be lost through open outlets or non-critical use points. Where check valves are used, they shall be redundant in series, resilient seated bubble tight, and sized based on actual flow rate coefficient and velocity, not line size. A dedicated critical air storage tank with supply inlet check valve, automatic control valves, monitored emergency reserve nitrogen manifold, or other means as approved by the NIH shall be provided. A suitable check valve shall be present in the discharge of each compressor (upstream of the storage receiver). For sterilizers, a dedicated air compressor at each autoclave (with receiver) can also be used for backup or primary air supply, provided a sufficient reserve is available and arranged to preserve any compressed air gasket seals or other critical component including under power failure. Required capacity shall be sufficient for critical needs and to maintain sterilizer gasket seals (where air gaskets are permitted) for at least the duration of simultaneous longest loads (liquid cycle) of each sterilizer. Where sterilizers use steam gaskets during operation or crush-seal

gaskets, the load of sterilizer door gaskets is not required to be addressed as critical compressed air, unless an air gasket seal is utilized for normal (standby) mode of a pass through autoclave.

*Rationale: Air systems must maintain intended failure control sequences in the event of supply failures. The check valve upstream of the receiver is required to prevent loss of air supply in the event the air-compressor supply source becomes disabled.*

**C. BAS Monitoring:** Critical control air systems shall include monitoring to BAS to indicate failure of the equipment or loss of required air pressure. Pressure of backup or reserves (e.g., high pressure gas manifold banks), including storage receivers used as backup shall be automatically monitored to assure required capacity. Where supply valves are not locked open, automatic pressure monitoring or valve tamper switches are required; arranged to detect loss of the required supply.

**D. Biohazardous Contamination:** Systems shall not be configured in any manner where the airstream can be subject to biohazardous contamination. An approved pipeline filter arrangement shall be provided where such a condition could plausibly occur. Filters are not normally required.

**E. Piping/Tubing System Materials and Location:** Control air piping shall be appropriately supported and adequately protected from damage. Piping/tubing and joint connections shall be of approved metallic materials (typically stainless steel or copper). Plastic tubing is not acceptable. Piping shall be clearly labeled as BSL-3 Critical Compressed Air.

## 8.6.9 Waste and Vent Systems Serving BSL-3

### 8.6.9.1 General Requirements

**A. Drainage and Vent System Design:** Waste systems shall be atmospherically vented to the building exterior and shall include deep seal traps for all drain inlets within containment. Traps shall be selected to exceed



the exhaust fan static pressure to maintain at least a 37–50 mm (1.5–2 in.) seal depth under HVAC operating and fan failure modes, as well as extra depth as required for control of pressure transients. Traps shall be of P-trap configuration, constructed of a radiused U-bend or an arrangement of a 45° ell, a 1/4 bend, and 45° ell back to horizontal in that order. Detailing is required as such traps must be field constructed. Traps shall be self-scouring and chemically resistant to disinfectants and shall not have flat or horizontal bottoms. Traps shall be liquid seal-type only, and shall not have gaskets, access covers, or any other means that can defeat the seal or allow potential air leakage. The tailpiece length of drains shall be sufficient to maintain the trap seal during potential pressure oscillations. Avoid excessive trap seal depth and coordinate with casework; however minimum seal requirement is typically 127 mm (5 in.) or greater.

*Rationale: Atmospheric venting arrangements maintain sealed construction and ensure venting to the exterior and discharge to the sewer where survival of sufficient viable infectious organisms from properly designed and operated BSL-3 areas are unlikely to pose hazards. Trap seals protect from cross-contamination but can be lost due to pressure differentials and fan failure modes; therefore, relating the trap seal depth to the potential pressures in the space as well as imposed pressure transients is required.*

**B. Vent Termination:** Vents shall terminate above the roof at least 7.6 m (25 ft.) from air intakes, building openings, or areas where persons may be normally present and shall be placed at locations to prevent re-entrainment into facilities.

**C. Waste and Vent Opening Locations:** Waste and vent openings from other piping systems (serving other building areas) are not permitted within the containment barrier. Openings from containment piping systems necessitating effluent treatment or decontamination shall not be located outside the respective level of containment.

*Rationale: Openings from other systems can introduce cross-contamination hazards, especially if trap seals are lost.*

**D. System Arrangement and Connected Wastes:** All drain inlets within containment shall discharge to the dedicated waste system serving BSL-3 facilities, including lab sinks, aerosol challenge room sinks and drains, mop sinks, and other fixtures within the barrier unless otherwise required. Drain ports (or openings that could be used as drains) from gloveboxes and other primary containment devices shall not be connected to building waste and vent systems.

**E. Systems Grouping:** Waste and venting systems for BSL-3 areas shall be zoned separately from other waste or vent streams and shall be provided with independent vents extending above the roof. Separate collection may be waived for existing facilities if separate systems would be impractical or are unnecessary by the risk assessment, where not carrying solids and risk of waste systems stoppage or potential of cross-contamination is deemed minimal, where floor drains are not provided within containment, and where required future flexibility would not necessitate such grouping. Where the waste from BSL-3 areas will be combined with other spaces, the waste lines serving BSL-3 areas shall be segregated to the extent possible (e.g., to main stacks, risers, building drain, or building sewer). BSL-3 waste and vent systems shall not be combined with waste systems from higher containment levels prior to effluent treatment of the higher risk waste.

*Rationale: Separate systems provide program flexibility (e.g., in the event waste treatment is required in future for certain agents), and minimizes potential for backup of wastes and cross-contamination. The point of separation should be carried ideally to the building sewer, but may be combined at the building drain or dedicated waste mains where required and acceptable to the program requirements and the risk assessment.*

**F. Piping Materials:** Corrosion-resistant pipe materials with thermal fusion joints shall be utilized for the waste and vent systems serving BSL-3 areas, and shall be compatible with the range of chemicals/disinfectants that may be utilized. Acceptable piping and joint materials for waste systems serving BSL-3 areas shall be selected from the approved corrosion-resistant materials, as per [Exhibit 6.3](#).

**G. Gravity Discharge/Order of Treatment:** Waste shall discharge by gravity to the sanitary sewer (or pH treatment system), without use of lift stations or pressurized waste. Where treatment is required, such treatment shall be provided prior to pressurizing waste. Where no treatment is required (as is typical for BSL-3) waste may be lifted only where necessary, in accordance with [Section 8.4 Drainage Systems](#) of the *DRM*.

**H. Floor Drains/Floor Sinks in High Containment:** Floor drains/floor sinks shall be avoided in containment. Consult with the ORF, DOHS, and the approved risk assessment for direction. Floor drains used in spaces where agricultural agents are manipulated and open housing may require enhanced requirements, e.g., biowaste systems and effluent decontamination.

*Rationale: Floor drains can present points of introduction for infectious waste that should otherwise be autoclaved. Infectious waste shall not be discharged through waste systems serving conventional BSL-3 areas.*

**I. Trap Seal Maintenance and Drain Placement:** Trap seals shall be maintained through the use of fixtures, manual pouring of disinfectant seal liquid, and avoidance of placement of drain connections where fixtures are unlikely to receive routine use sufficient to maintain seals. Water-fed trap primers are not typically utilized in containment. Alternative mechanical trap seal arrangements are not acceptable.

*Rationale: Automatic primers can flush disinfectants from trap seals that may be required for protocols for the current, or future agent, as well as backflow hazards where such devices are not adequately maintained.*

**J. Cleanouts:** Waste pipe clean-out access shall be arranged similar to other piping penetrations to maintain integrity of the containment barrier, typically arranged as a threaded capped or plugged pipe extension through a wall.

**K. Drainage Inlet Grinders:** Drainage inlet grinders (food waste disposers/garbage disposals) shall not be utilized in BSL-3 facilities.

*Rationale: Infectious waste shall not be disposed through building drainage systems or include arrangements with significant potential for aerosolization of infectious waste.*

**L. Equipment Connections:** Where waste connections are required for incidental lab equipment (e.g., ice machines and small equipment) drainage connections shall be made as indirect connections per [Section 8.4 Drainage Systems](#) and as follows:

1. Through an adjacent wye-branch sink tailpiece at the trap inlet and within the same suite; (or)
2. Where no adjacent fixture is present or where required by elevation, clean waste from equipment may discharge through a suitable in-room condensate pump into a wye-branch tailpiece of a sink or other approved indirect waste receptor located in the same room; (or)
3. A fixture trap serving a normally used lab sink or similar fixture may be placed below the floor to facilitate the installation of a wye-branch tailpiece at a low elevation to serve floor mounted equipment or other connections at low elevation. The trap shall be oversized at least one pipe size larger than the fixture drain to prevent self-siphonage, and shall be at least 50 mm (2 in.) diameter; (or)
4. Subject to the risk assessment and where the above approaches are not viable, equipment may be fitted with a dedicated trap provided:
  - a. The trap is visibly located (unconcealed) with provisions to facilitate the manual routine maintenance of seal liquid disinfectant.
  - b. An indirect connection (air gap or air break) is maintained.
  - c. The trap includes an isolation valve to permit shut-off on the upstream side of the trap for use when equipment is not active or connected.

Where the use of floor drains is approved, waste may discharge over a floor drain or floor sink but only in the same room/suite served. The use of floor drains in labs, including BSL-3 is avoided and any inclusion must be



evaluated in the risk assessment and approved by the NIH. Funnel-drain arrangements (without floor drain capability) are acceptable.

*Rationale: Discharging equipment waste to a normally used fixture within the same suite of containment minimizes the potential for a dry trap or omission of disinfectant. Portable condensate pumps to lift waste from ice machines to sink trap inlets within containment is preferred over the use of extended length tailpieces due to the potential of an equipment drain being a point of relief for backup of wastes.*

**M. Anterooms and Similar Spaces:** Plumbing connections serving anterooms at the containment barrier shall drain to waste systems serving conventional BSL-2 areas unless justified by the risk assessment and approved by the NIH. Deep seal traps are required at anterooms where ventilation systems are common to the systems serving the high containment areas. Where effluent treatment is required, these systems should not extend to serve anteroom spaces or showers due to risk of waste backup and potential for cross-contamination during normal operation or maintenance.

**N. Shower-Out:** Drains from showers (shower-out) serving BSL-3/ABSL-3 facilities shall route to the sanitary drain or general (BSL-2) lab waste serving the space where the fixture is located, but shall be fitted with a deep seal trap for containment fixture drains. Shower drains for BSL-3/ABSL-3 spaces do not route through effluent decontamination unless specifically required by the risk assessment and approved by the DOHS and ORF.

*Rationale: Drains from showers do not typically pose significant risk of viable agent release. Occasionally the presence of showers may be required within a BSL-3 containment boundary however the presence of a shower at such locations does not automatically justify an effluent decontamination system.*

**O. Emergency Drainage, Fire Sprinklers:** Special floor drains, diking, and troughs are not required to accommodate fire-sprinkler drainage in BSL-3 spaces (including ABSL-3 spaces). For special conditions (e.g.,

BSL-3Ag/GLSP where floor drains are unavoidable), the issues of waste water control and capture shall be reviewed on a project specific basis.

**P. Autoclave/Sterilizers:** The sterilized effluent from BSL-3 autoclave chambers fitted with decontamination of all chamber effluent may discharge through the sanitary system or general building lab waste system as an indirect connection through a floor sink. The drain receptor shall be located on the clean (non-contained) side of the bioseal (typically within the clean sterilizer service access area). Where hard piping of the sterilizer chamber drain is required, comply with the following:

1. Where the entire sterilizer is permitted to be located in containment (i.e., applications with no clean side or clean utility access area), or for any case where the use of an autoclave without full decontamination of all effluent is deemed acceptable by the risk assessment and approved by the NIH, the autoclave drain shall be hard piped to the drainage system through not less than a 75 mm (3 in.) diameter deep seal trap, with a trap inlet tailpiece of at least 50 mm (2 in.) diameter. A suitable full way valve shall be provided within the autoclave service area at the hard piped connection to the drain tailpiece so as to permit isolation of the autoclave for service (and associated pre-service decontamination). A properly labeled air vent shall be extended from the autoclave drain connection upstream of the tailpiece drain valve (located just prior to the sterilizer connection), and the termination of the vent shall be extended to the exterior (not connected with sanitary or non-similar vents) to maintain atmospheric pressure on both sides of the trap. The vent shall be provided with an in-line filter with decontamination ports for any case where the chamber vacuum is connected through the drain and does not include suitable upstream filters as part of the autoclave equipment, as well as for any case where an autoclave is connected to a biowaste system, or where otherwise required by risk assessment. Where vent filter is provided, it shall be located above the bottom of the autoclave chamber, and shall be sized to permit free flow of air. The sterilizer chamber drain inlet vent does not supersede requirements to properly vent the drain trap per plumbing code. Vents shall be free draining, and where filters are provided they

shall be installed upright and vent lines shall be arranged to prevent trapping of liquids on either side of the hydrophobic filter or provide alternative approved methods of protecting for trapped liquids (such as heat jacketing).

2. For any case where the filters are located external to the sterilizer service area, an isolation valve shall be provided on the vent prior to leaving the sterilizer service area and a decon port provided within the service area to facilitate manual filling of the trap with disinfectant or gaseous decontamination. The decon port shall be located on the sterilizer side of the tailpiece drain valve.
3. The chamber drain tailpiece vent shall be constructed of brazed or soldered copper tubing, stainless steel, or other approved metallic material.
4. A clean-out may be provided at the inlet of the drain tailpiece. Outside of containment (including within the autoclave service area), a floor drain may be provided on the horizontal fixture branch serving the sterilizer drain, provided with a deep seal trap and automatic trap seal primer as necessary or as otherwise required to facilitate a satisfactory indirect-waste arrangement. A trap seal primer, located inside containment, may be utilized where required to maintain the trap seals serving autoclave chamber drains that are not connected to a biowaste system where such are subject to infrequent use; however, conventional trap seal primers shall only be used for protecting trap seals serving sterilizers where all effluent is sterilized prior to discharge to a non-biowaste system. Trap seal primers are not typically required for hard connected sterilizer chamber drains subject to frequent use, and especially for sterilizers with water ejectors.
5. Jacket condensate shall be returned to the steam condensate return system in a manner to prevent backpressure on the sterilizer, or shall be spilled to a floor drain outside of containment where approved. Jacket condensate shall not be hard piped to the drainage system.

*Rationale: Locating drains within the service area on the non-contained side prevents having a containment drain outside of containment or a non-containment drain within containment. Hard piping of equipment is acceptable where necessary by the risk assessment but not desirable if the drain can be located in an approved manner in accordance with DRM requirements and adequate treatment of all effluent (including the pre-vac cycle) is present in the autoclave equipment selection. Provision of a floor drain outside containment on the fixture branch serving the drain and at the same elevation provides a relief point for backflow and the equivalence of an air-break indirect waste.*

6. Autoclave capture hood condensate shall discharge to a receptor or vessel on the same side of containment as the respective hood. No arrangement which could result in creation of an opening through containment is permitted (including use of water seal traps).

### 8.6.9.2 Effluent Decontamination, Waste Treatment, and Biowaste for BSL-3

**A. Application and Permissibility:** Effluent decontamination systems (EDS) are not typically required or desirable at BSL-3. Use and design of effluent decontamination systems (EDS) shall be based on the approved risk assessment and concurrence of the NIH and program biosafety officer, based upon a scientific/safety necessity. Where EDS is required, appropriately designed biowaste and vent filtration is also required. Decisions to incorporate EDS should be carefully evaluated prior to commitments.

*Rationale: BSL-3/ABSL-3 spaces rarely have a need for effluent treatment and associated biowaste/vent. Presence of such systems may result in increased hazards. The comprehensive requirements necessary to provide, operate, and maintain systems safely and reliably can result in significant initial and ongoing costs.*

## 8.6.10 Liquid Nitrogen and Cryogenic Fluids Serving BSL-3 Laboratories

**A. Vacuum Jacketing:** Systems shall be insulated with static (passive) vacuum jacketing only. Dynamic vacuum jacketing is not permitted.

*Rationale: In the event of breach of any jacket seal, there should be no induced vacuum through the system to the outside of containment.*

**B. Oxygen Monitors/Sensors:** Oxygen monitors/sensors shall be suitable for fumigation requirements. Air shall not be pulled out of containment for sampling.

*Rationale: Improperly selected gas monitors can be damaged by fumigation gases. The use of sensors with electronics in compatible enclosures, or remote sensing monitors (non-air sampling type) can be selected.*

## 8.6.11 Plumbing Fixtures Serving BSL-3 Laboratories

### 8.6.11.1 Faucets

**A. Faucet Types:** Faucets within containment shall have gooseneck-type spouts and be fitted with integral ASSE 1001 atmospheric vacuum breaker and laminar flow, non-aerating, non-splash outlet. Flow rates for hand wash faucets shall be at least 8.0 lpm (2.0 gpm). The use of separate outlet taps for hot and cold water is not acceptable. Faucets serving dedicated hand wash lavatories outside of the laboratory or animal holding rooms (e.g., lavatories at change rooms) do not require a vacuum breaker unless fitted with an outlet that may receive a hose.

*Rationale: ASSE 1001 vacuum breakers provide required point of use high hazard protection. Laminar flow and minimum flow rates are for adequate water flow for washing and lab use, while maintaining water conservation and control of splashing.*

**B. Hands-Free:** Sink faucets shall be hands-free type that are either electric sensor operated and hard-wired to AC power, or foot pedal actuated with slow-close off-the-floor mounted valves with flip-up pedals to permit cleaning. Battery-actuated faucets and faucets that require use of hands, wrist, or elbow are not acceptable. Knee operated valves shall include suitable anchorage, or shall be knee-panel type with pneumatic control valves (scrub-sink type). Hand wash faucets are required to be fully hands-free type, no overrides to complete hands-free operation will be permitted. Additional sinks within the room (in addition to the hand wash sink required at the exit) may be wrist-blade actuated, though off-the floor foot pedal is recommended. Approval for any sink to not have hands-free operation capability is subject to acceptance by DOHS.

### 8.6.11.2 Showers

**A. Requirements:** Hand-held showers shall not be utilized, except where specifically required for barrier-free compliance and shall include a vacuum breaker. Flow rate reduction below 10 lpm (2.5 gpm) is not permitted. Fixture count shall be evaluated for throughput requirements.

*Rationale: Hand showers are undesirable due to additional maintenance issues and potential for immersion and backflow (e.g., where showers are used for transfer of materials), but are not prohibited where otherwise necessary.*

**B. Materials:** Showers walls and bases shall be of a durable, impervious design. The use of waterproof epoxy over masonry, stainless steel, or ANSI A137.1 impervious-class porcelain tile floors with epoxy grout (not cement grout) is required. Refer to [Section 8.2.9 Showers](#) for safing membrane requirements.

*Rationale: Impervious-grade heavy-duty tile is used for durability and absorption and epoxy grout is preferred due to imperviousness, mold, and chemical resistance.*

**C. Shower-Out Egress Location:** Showers at the shower-out egress location prior to change to street clothes, is a transitional boundary and not considered within BSL-3 biocontainment. With the exception of agents of agricultural significance, such fixtures shall not be connected to containment lab drainage, as such connections could be subject to backup from lab wastes.

### 8.6.11.3 Water Closets

**A. Inside Containment:** Where the DOHS grants approval for water closets to be located in an area that is inside containment, a deep-seal, vented, self-cleaning trap arrangement shall be provided directly below the fixture, and a wall-mount 13.5 lpf (3.5 gpf) blow-out flushing action closet shall be provided. The deep seal P-trap shall be located directly below the vertical fixture waste with the vent located immediately downstream of the trap, and a vent shall also connect vertically as an extension from the trap inlet to maintain atmospheric pressure on both sides of the trap. The trap shall be constructed with a 45° ell, radiused quarter bend and 45° ell in that order. Water closets should be located outside of containment on the clean side of showers where possible.

*Rationale: Fixtures within containment can be subject to extreme pressure differentials resulting in loss of trap seals. As water closets are furnished with integral traps, double trapping is necessary to achieve the required traps seal depth for these applications. Fixture type, trap location, and configuration protects from stoppages.*

### 8.6.11.4 Sinks/Lavatories

**A. Stainless Steel Preferred, Smooth, Non-Sharp Surfaces:** Stainless steel is the preferred material for use within containment where free-hanging sinks are required (i.e., with the exception of phenolic/epoxy sinks integral with casework). Where stainless steel sinks are utilized, surface undercoating and sound-deadening

pads shall be omitted due to sharp edges, porosity, and cleaning issues.

**B. Vitreous China Sinks:** Vitreous china sinks shall not be used in holding rooms, materials corridors, materials handling areas, or other areas where susceptible to damage.

**C. Fixture Overflows:** Within insectaries and for all applications of fixtures connected to biowaste systems, sinks/lavatories shall be furnished without overflows.

*Rationale: This is to avoid the concealed areas associated with overflows which may be subject to buildup of solid material that may not be readily decontaminated.*

### 8.6.11.5 Mop Sinks

**A. Materials:** Service sinks within containment shall be constructed of enameled cast iron or stainless steel. Faucet outlet shall be provided with a vacuum breaker.

### 8.6.11.6 Fixture Trap and Supply Insulation Kits

Insulation kits shall not be used in containment.

*Rationale: Ensures cleanable surfaces for fumigation, and allows for visual inspection.*

### 8.6.11.7 Floor Drains/Floor Sinks/ Drain Troughs

Floor drains/floor sinks, trench/trough drains, etc., should be avoided in containment. Where not avoidable, or where specifically required by the program and in accordance with the risk assessment and approved by the DOHS, the following requirements apply:

1. Floor drains and floor sink tops shall be constructed of at least grade 316 stainless steel or other approved corrosion- and chip-resistant construction with all openings and edges smooth and free of sharp hazards.
2. Drains shall include provisions for positive gas-tight closure, which shall be repeatable.



3. Drains shall be designed to allow interception of solids for autoclaving. Sediment buckets that ensure grate replacement and are free of sharp edges shall be provided as appropriate. See [Section 8.2 Plumbing Fixtures and Equipment](#) for additional information.

*Rationale: Inclusion of floor drains within containment may, in some cases, necessitate effluent decontamination systems and associated biowaste/vent piping arrangements (e.g., where potential introduction of agents of veterinary or agricultural significance may occur). Eventual loss of trap seals will occur where not used; therefore, the gas-tight cover could become the primary seal of the drainage system. Many cover designs are not truly gas-tight, insect-tight, or repeatable; therefore, the seal configuration must be appropriately specified.*

#### 8.6.11.8 Emergency Fixtures

**A. Compliance:** Emergency fixtures and associated water supplies shall comply with [Section 8.2 Plumbing Fixtures and Equipment](#) and [Section 8.3 Water Systems](#) and required locations shall be determined in accordance with the risk assessment. Service shall be configured as an isolated potable supply, with ASSE 1013 backflow protection provided for services prior to entering containment. Eyewash fixtures shall be selected to maintain a fixed air-gap above the flood level rim.

### 8.6.12 Special Materials and Equipment

**A. Recessed Equipment (Hose Stations, Emergency Shower Actuation, Etc.):** The use of recessed box devices (as opposed to selection of equipment that is exposed and stood-off from the finished surface) should be avoided. However, where such arrangements are required or preferred as per the program requirements, the assembly shall be arranged to prevent breaching the containment barrier, and shall not have concealed or inaccessible areas, which may harbor insects. The box shall be constructed of stainless steel with a solid back and sides, and all penetrations into the box shall

consist of permanently sealed pipe inlet and outlet lines (typically welded if in ABSL areas) to maintain rigid, gas-tight penetrations. The box design shall include an appropriate surface flange to permit sealing the device to the containment barrier wall construction, and be arranged to provide a gas-tight finished installation. Device mounting to stand-off from walls is preferable, easier to seal, clean and maintain, and more economical.

#### 8.6.12.1 HEPA Filters/In-Line Filters

**A. In-line Filters:** In-line filters for gaseous piping systems shall be as determined appropriate through the risk assessment, and shall be sterilizing grade per ASTM F838, membrane, or double-membrane cartridge type, absolute rated for aerosolized virus particles in high humidity gas, and shall be bacteria rated in liquid streams at 0.2 microns (or less), with moisture-resistant inherently hydrophobic construction of PTFE, PVDF, or sintered stainless, a leak tight frame or cartridge design of thermal melt-sealed construction, and double O-ring seals of compatible elastomers to avoid bypass leakage. Housings shall be at least 316 stainless steel or equivalent corrosion-resistant metal compatible with system application, dead-leg-free sanitary type housing and designed for the media (e.g., gas system applications). Filters for critical flow volume applications shall be oversized with sufficient safety factor to ensure required performance. Filters shall be 100% integrity tested. Pressure drop/resistance to flow to be considered. Materials shall be confirmed compatible with the decontamination method. Hydrophobic fluoropolymer membrane (typically PTFE) type filters, at least HEPA efficiency for liquid and gas streams may be utilized as approved by DOHS and consistent with the risk assessment. N + 1 redundancy is required for filters serving multiple use points and central equipment.

**B. Filter Selection:** The filter selection shall provide the required efficiency at the minimum and maximum system operating velocity and pressures and shall be sized as required for airflow rate, velocity, and permissible pressure drop under loaded conditions. Where steam sterilization is utilized, filters shall be compatible without deterioration. Unless otherwise approved, filter selection for vacuum systems shall ensure total pressure drop through the filters and housings does not exceed 12.7 Torr (0.5 in. Hg) at design flow. The flow rate through the vacuum filter and housing shall be determined acceptable and factored into design calculations.

**C. Isolation Valves/Decontamination/Validation Ports, General Installation:** Isolation valves and decontamination ports shall be provided at filter inlet and outlet, with a tight-sealing threaded cap to prevent a direct opening (such as in the case of accidental operation of a valve). Assembly shall be compatible for complete gaseous or vaporous decontamination and shall be installed vertically to self-drain and prevent moisture accumulation. A valved and capped drain port shall be provided for pipeline filters on vacuum systems and vents only if required and not avoidable, and shall include appropriate signage. Gas-tight connections shall be provided and the type of connection shall maintain a tight seal under anticipated system vibration and thermal cycling conditions. Where ports are stainless steel, the use of forged brass caps should be provided to protect from galling of stainless steel. Piping shall slope to drain away from filters and to facilitate free air flow, without trapped sections.

**D. Decontamination and Validation Provisions and Process:** Filters shall be validated as an assembly (integrity test certified) for efficiency and leak integrity by the manufacturer and shall be validated again in situ. Certification of tests and procedures shall be forwarded to the DOHS and ORF for approval. Each filter shall be arranged for in-place validation, decontamination, and replacement with valved and capped decontamination ports. The approach to filter maintenance, decontamination, and values for integrity testing/validation shall be documented in the SOPs, and as approved by the DOHS.

**E. Installation of Filters:** Filters shall be placed only in the vertical, upright position and arranged to preclude trapping of liquid. Where necessary to prevent blockage (e.g., may be required for some vent filtrations), heat tracing shall be provided to maintain at least 5°C (41° F) above operating temperature or as otherwise required.

### 8.6.12.2 Gas-tight Check Valves

Where valves are approved for backflow protection of gases (in lieu of sterilizing grade in-line filters), such valves should be loaded type, designed to seal bubble-tight under pressurized and non-pressurized (static) conditions utilizing small molecule gas (e.g., helium). Valves shall be designed to be gas-tight with low leakage, certified for across the seat and either inboard or outboard leakage rate; and shall be provided with test ports on both sides of the seat for in situ validation with gas-tight test valves and caps. Valve body and seats shall

be constructed of compatible corrosion-resistant materials for the application (typically stainless steel or brass with PTFE or similar non-contaminating fluorocarbon seats) and shall maintain a sufficient cracking pressure of not less than 6.9 kPa (1 psig). Where resilient seats are used, they shall be compatible with the process fluid and any fluid intended to be used for decontamination and sizing based on flow rate coefficient and velocity (verses matching of line size) is mandatory.

### 8.6.12.3 BSL-3 Vacuum Valves

Valves shall be Type 316 stainless type (or to match piping material), high-performance full-port 316 stainless ball valve and trim, rated for vacuum service and pressure of at least 4,137 kPa (600 psi) WOG (water, oil, gas), locking type, with PTFE or Viton seat and top entry, live loaded double-stack chevron, cup and cone, bellows, or equivalent PTFE-based ASME B31.3 Category “M” zero-leakage/low-emissions packing chamber design. Equivalent sealed bonnet diaphragm valves with approved chemically compatible elastomers may also be utilized where such valves are designed for vacuum service. Downstream of the second filter, standard full port lab vacuum system valves may be utilized unless otherwise directed by NIH or determined necessary by risk assessment.

## 8.6.13 BSL-3 Plumbing Requirements for Special Applications

**A. Additional System Design Requirements:** Special applications including but not limited to GLSP, facilities intended for manipulation of select agents, agents of veterinary or agricultural significance, recombinant DNA facilities, and work with special vectors (e.g., arthropods) may be subject to additional system design requirements and shall be provided in accordance with the risk assessment and project-specific requirements of the ORF and DOHS.

**B. GLSP Facilities:** Backflow protection is required at each service connection and shall not induce contamination. Water connections required to equipment shall be treated as high hazard connections. Plumbing system arrangements must address failure sequences (including



pressure-relief discharges), seal integrity, overflow/spillage, required containment capacities that could result in the release of viable agent.

**C. Insectaries:** Plumbing connections in arthropod facilities shall be subject to review and approval of the DOHS and ORF, and shall be in accordance with an approved risk assessment as well as [Appendix O.1 Insect Facilities](#). There shall be no uncontrolled escape paths for any life stage of arthropod through piping networks.

1. Drain openings in insectaries shall be provided with durable, tight fitting double-layer stainless steel screens with openings sufficiently small to prevent escape (but not larger than 52 mesh), and free of sharps hazards. Sinks should include normally closed 1/4 turn valves on the inlet tail-piece for each individual trap, unless waived.
2. Floor drains shall be avoided in insectaries.

The use of an approved, effluent treatment arrangement and a controlled collection system suitable for fumigation may be required, and shall be arranged to prevent any uncontrolled release (including provision of vent filtration). Where effluent treatment of any type is used, only systems fully controlled to maintain validation of efficacy for purpose with the waste streams without release or escape of untreated wastes (or arthropods) or plausible exposure of wastes to personnel under any condition may be used, and no holding tanks or vessels that do not incorporate treatment are permitted.

Where insecticide, disinfectant or other chemical treatment arrangements are utilized, conformance with the Insecticide, Fungicide, and Rodenticide Act is required.

3. Utilities shall be provided with a suitable, replaceable filter or screen assembly, within containment and near to the point of use, and appropriate for the system application, consistent with the risk assessment. The screen/filter shall be sufficient to allow for proper flow/pressure drop, while preventing any escape path for arthropods. The size of any openings shall be sufficiently small to prevent escape, but in no case shall openings be larger than 52 mesh. They shall be free of sharps hazards. An attached screen/filter is required for vacuum systems.

*Rationale: Drain openings are screened and valved to protect from insect harborage and cross-contamination. Valves at the drain inlet are used to seal off systems to prevent transfer between spaces and may be required for some SOP's to ensure sufficient local chemical treatment to eradicate arthropods prior to discharge. Floor drains are avoided in insectaries to avoid uncontrolled insect breeding. Utilities are screened as lines may not always be under positive pressure. Vacuum may not always have the point of use filter attached, therefore screens or permanent point of use filter arrangements are required.*

4. Piping materials and appurtenances that may be exposed shall be verified to be compatible with pesticides which may be utilized in the space.

*Rationale: Some agents that may be required can induce stress cracking, permeation, or other problems with various piping materials, especially some plastics and certain elastomers.*

**D. Select Agents and Veterinary/Agricultural Pathogens:** Where pathogens of veterinary (or agricultural) significance are manipulated or animals housed such that the room becomes the primary containment barrier, additional requirements of the USDA APHIS may also apply and shall be discussed with DOHS and ORF prior to design.

## 8.6.14 Containment Autoclave Chamber Pressure Relief

**A. Chamber Pressure Relief Devices:** Provisions shall be made for the safe discharge of pressure relief devices serving chambers in accordance with the risk assessment. The selected arrangement shall not compromise relief of overpressure conditions or allow escape of viable agent due to leakage, discharge, or malfunction, or result in damage of the facility/containment or injury associated with a discharge event. For BSL-3 applications, the use of a combination spring-type pressure relief valve with a sealed bonnet along with a lower-pressure inlet rupture disk and incorporation of a burst

indicator/pressure sensor between the components should be provided. Other approved sealed designs compliant with ASME standards, with discharge piping to a safe location consistent with the risk assessment and applicable codes may be used.

**B. Relief Lines:** Where the relief line is routed to the exterior or extensively piped, or where provision of stainless steel mesh HEPA pipeline filters is required by the risk assessment, the effects of buildup and superimposed backpressure shall be considered, and components shall be arranged to permit decontamination and ensure conformance with ASME code. Relief lines shall not be subject to cross-contamination from other sources. Relief lines shall be sloped to prevent trapping of liquid, and reliefs to the exterior shall be turned down to prevent ingress of water. Where steam is piped at higher pressure from the jacket to the chamber and provided a tight sealing check valve and a normally closed isolation valve is also provided between the jacket and the chamber, the use of a rupture disk and associated burst indicator ahead of the relief valve may be waived where approved in accordance with the risk assessment.

**C. Relief Valves to Drains:** Piping of pressure relief valves to drains as a hard (direct) connection is not acceptable even where biowaste and effluent treatment is provided. A small drip line shall be provided at the low point to the floor drain or floor sink to allow free drainage.

*Rationale: The potential discharge of chamber relief from autoclaves and similar equipment should be in accordance with the facility risk assessment and consider any potential of spilled or unsterilized liquids and risks from viable agents, as well as other safety/facility damage hazards. Typically, provision of the rupture disk and burst indicator with automated steam shut down ahead of the sealed bonnet relief valve is sufficient with the relief piped outside. The arrangement is typically also suitable for applications where steam is piped from the jacket to the chamber, with autoclaves that are designed for such arrangement and therefor only using a single relief valve. Piping relief valves to drains as a hard connection can induce superimposed backpressures as well as other hazards to the system and occupants. Filters are not normally*

*desirable due to back pressure risks, and where required must be non-hydrophobic type to ensure free relief path.*

## 8.6.15 Special Testing and Inspection Requirements

**A. Baseline Criteria:** The A/E shall refer to [Section 2.5 Biocontainment Facility Predesign](#) and [Section 2.6 Biocontainment Facility Design](#) in Chapter 2 and the preceding sections of this chapter and [Chapter 12: Special Process Piping Systems](#).

**B. Conformance:** Conformance with the requirements of this chapter shall be confirmed in the installation of plumbing systems serving BSL-3 containment. Systems shall be inspected throughout installation to ensure conformance with the requirements of the design documents and *DRM*. In addition, the following specific issues shall be addressed as part of quality control, testing, and commissioning plans.

### 8.6.15.1 All Piping Systems

**A. Standing Pressure:** Standing pressure test at least 1.5 times design operating pressure for 8 hours.

**B. Standby Power/Integrated Systems:** Ensure all required standby power and proper response to integrated systems testing has been provided.

**C. Cross-Connections:** Confirm no cross-connections exist between inlets in BSL-3 containment and non-contained spaces, all piping is properly labeled, and all backflow preventers present and tested.

### 8.6.15.2 Waste and Venting Systems

Confirm each drain and vent are connected to the proper system. Provide final test for systems integrity after traps are filled as described in [Section 8.4 Drainage Systems](#) for general waste systems. Verify the venting arrangement. Trap seals in waste systems shall hold tight with at least 37 mm (1.5 in. w.g.) trap seal remaining under actual system HVAC fan tests, operation, and failure conditions.

### 8.6.15.3 Plumbing Fixtures and Equipment

Plumbing fixtures shall be tested for proper operation, flow, and pressure. Correct fixtures shall be installed at each location in conformance with the *DRM*. Gas-tight drains shall be installed to provide required seal testing with dry traps. Sediment baskets/strainers shall be present where required. Fixtures shall be properly caulked. Each equipment item shall be checked for proper connection to the respective systems. Comply with requirements of [Section 8.2 Plumbing Fixtures and Equipment](#).

### 8.6.15.4 HEPA/In-line Filters

Validate performance of complete assembly (filter as installed in housing) in situ after completion of entire system installation. Threaded caps shall be installed for all decontamination ports. Filter shall be properly located and arranged in a visible, accessible manner to permit decontamination, validation, drainage, and servicing. Verify no potential of filter blockage. Confirm proper operation of heat tracing where required. Review required replacement frequency with manufacturer requirements and coordinate with Operations and Maintenance (O&M) documentation.

### 8.6.15.5 Critical Compressed Air

Verify required capacities are provided under simulated failure conditions, and all required alarms present and properly operational, including automatic pressure monitoring of the emergency reserve, and (in the case of cylinders) full cylinder banks properly restrained and emergency valves locked out.

# Chapter 9

---

## Fire Protection & Suppression

# Section 9.1

## Fire Protection Systems

---

### Contents

9.1.0 Introduction

9.1.1 Codes and Standards

9.1.2 Authority Having Jurisdiction

9.1.3 Occupancy Classification

9.1.4 Laboratory Fire Hazard Classification

9.1.5 Fire Resistance-Rated Construction

9.1.6 Flammable Liquid Storage Cabinets

9.1.7 Glazing

9.1.8 Listed Equipment

9.1.9 Design Documentation

9.1.9.1 Fire Protection Submission Guidelines

9.1.9.2 Fire Rated Assemblies

9.1.9.3 Sprinkler System Submittals

9.1.9.4 Fire Hydrants

9.1.9.5 Fire Alarm Systems

## 9.1.0 Introduction

The following design requirements apply to all fire protection systems. The engineering goals and objectives are to provide uniformity of design, combine the best overall economy with suitability of design, and be compatible with all other building systems. Provision shall be made for expansion as determined by the NIH on a project-by-project basis.

### 9.1.1 Codes and Standards

**A. General:** Fire protection design shall follow the latest edition of the following unless amended herein. Applicable editions shall be those in effect at the time of the contract notice to proceed.

1. National Fire Protection Association (NFPA) National Fire Codes (NFC). All portions of the NFPA NFC except NFPA 5000 shall be followed including annexes (as if “should” reads as “shall”), recommended practices, interim amendments, and formal interpretations.
2. International Building Code (IBC), except Chapter 10, Means of Egress, unless specifically altered or amended in this document.

**B. Code Application:** When a conflict between the various code requirements exists, the most stringent standard shall apply. Where NFPA 101 does not address an issue, the IBC requirements, if any, shall apply.

**C. Other Guidelines:** In addition to the applicable codes and standards as listed in this section and in [Chapter 1: Administration](#), projects shall comply with other safety guidelines received from the Project Officer (PO) or as required by the program.

## 9.1.2 Authority Having Jurisdiction

The NIH Division of the Fire Marshal (DFM) is the authority having jurisdiction (AHJ) for all fire protection and life safety provisions in the NFPA and IBC standards on NIH-owned property.

### 9.1.3 Occupancy Classification

For building construction requirements (e.g., construction type, heights and areas, exterior walls, load-bearing members), research and testing laboratories are defined as Use Group B and animal holding areas are defined as Use Group S-1 per the IBC. For life safety and fire protection requirements, laboratory units are defined as industrial occupancies per NFPA 101, Life Safety Code and animal holding areas are defined as business per NFPA 150, Animal Housing Facilities Code, and NFPA 101.

### 9.1.4 Laboratory Fire Hazard Classification

All laboratories using chemicals shall be designed in accordance with NFPA 45. NIH fire hazard classification for laboratory units shall be at minimum defined as Class “C” per NFPA 45 definitions, unless quantities of flammable and combustible liquids dictate otherwise and as modified below.

### 9.1.5 Fire Resistance-Rated Construction

All laboratory unit separation walls shall have a minimum one hour fire rating. All laboratory doors in one hour fire rated walls shall have a minimum forty-five minute fire rating.



## 9.1.6 Flammable Liquid Storage Cabinets

**A. Specification:** Flammable liquid storage cabinets (FLSCs) which are constructed of metal and listed by a nationally recognized testing laboratory (NRTL) shall be provided in each laboratory work area with chemicals.

**B. Size and Quantity:** The size and quantity of FLSCs provided shall be determined per NFPA 45 and coordinated with the end user.

**C. Location:** FLSCs shall be located as remotely as possible from the exit doors of laboratories. FLSCs shall not be located in corridors or beneath fume hoods.

**D. Integrity of Installation:** The integrity of FLSCs shall not be compromised by their mounting method. FLSCs shall not be movable.

**E. Venting:** FLSCs shall not be vented.

## 9.1.7 Glazing

All glazing shall comply with the IBC requirements.

## 9.1.8 Listed Equipment

All fire protection devices, equipment, and materials shall be listed for the intended use. “Listed” is defined as equipment and materials that are identified in the Factory Mutual (FM) *Global Approval Guide* and/or the various directories of Underwriters Laboratories (UL). Testing by another NRTL may be approved by DFM on a case-by-case basis.

## 9.1.9 Design Documentation

Drawings (including Construction Phasing Plans), specifications, and calculations must be submitted at appropriate stages of a project. Refer to [Appendix E: A/E Submission Requirements](#) for documentation requirements at the completion of each stage. In addition, comply with all requirements of this chapter.

### 9.1.9.1 Fire Protection Submission Guidelines

Contract documents shall reference the use of the *DRM* and the NIH Policy Manual 1370 for all fire protection system(s) in government-owned facilities. These manuals contain the requirements for design and construction submissions, shop drawing submissions, and inspections.

### 9.1.9.2 Fire Rated Assemblies

A drawing shall be provided as part of the design submission package showing all fire and smoke rated assemblies including barriers, walls, partitions, shafts, floors, and ceilings. Drawings shall graphically indicate laboratory unit boundaries and gross area.

### 9.1.9.3 Sprinkler System Submittals

Submit sprinkler system shop drawings showing final sprinkler locations in accordance with NFPA 13 requirements.

### 9.1.9.4 Fire Hydrants

**A. Location:** Construction drawings shall show the locations of all hydrants that are intended to protect a new or renovated facility.

**B. Details:** Hydrant and standard thrust block details shall be provided.

### 9.1.9.5 Fire Alarm Systems

**A. General:** Contract documents shall include device locations, riser diagrams, source of primary power supply, points of connection (including panel locations and types, circuit numbers, etc.), capacity of existing circuits, fire alarm zone boundaries (coordinate and align with sprinkler zones), and sequence of operations matrix.

**B. Fire Alarm Riser Diagram:** The Architect/Engineer (A/E) shall provide a fire alarm riser diagram on the contract drawings with the following information shown:

1. All fire alarm initiating devices (alarm and supervisory)
2. All fire alarm notification appliances

3. New or existing fire alarm control panels and any remote panels. Identify manufacturer of existing panel and show location of existing head-end equipment.
4. All interfacing devices (electric door strikes, door hold-open devices, auxiliary relays, and terminal cabinets)
5. Tie-in locations including circuit number, panel locations, etc.
6. Source of primary power supply (indicate panel number and circuit number)
7. Source of grounding

**C. Other Requirements:** Contract documents shall also include requirements for system programming, modification of graphic interfaces, and updating of system as-built drawings.

# Section 9.2

## Fire Suppression Systems

---

### Contents

#### 9.2.0 Introduction

#### 9.2.1 Automatic Sprinkler Systems

##### 9.2.1.1 System Design

##### 9.2.1.2 Design Criteria

##### 9.2.1.3 Backflow Preventer

##### 9.2.1.4 Drainage

##### 9.2.1.5 Materials and Equipment

##### 9.2.1.6 Installation

#### 9.2.2 Standpipe Systems

##### 9.2.2.1 Standpipe System Materials and Equipment

##### 9.2.2.2 Standpipe System Installation

#### 9.2.3 Fire Hydrants

#### 9.2.4 Fire Department Connections (FDCs)

#### 9.2.5 Fire Pumps

## 9.2.0 Introduction

The following design requirements apply to fire suppression systems. Provision shall be made for future expansion as determined by the NIH on a project-by-project basis.

### 9.2.1 Automatic Sprinkler Systems

**A. General:** All new occupied facilities, reconstruction, and/or additions over 185 m<sup>2</sup> gross (2,000 ft<sup>2</sup>) shall be fully sprinklered for compliance with the Federal Fire Safety Act of 1992. Facilities smaller than 185 m<sup>2</sup> (2,000 ft<sup>2</sup>) may be exempted only with prior written approval of the Division of the Fire Marshal (DFM).

**B. Classification:** All laboratory work areas shall be classified as Ordinary Hazard Group 2 throughout in accordance with NFPA 13. Special hazard areas requiring higher hazard classifications shall be protected in accordance with NFPA 13.

**C. Non-laboratory Buildings:** In all other areas that do not contain laboratories, the sprinkler systems shall be designed in accordance with the associated hazards per NFPA 13. Special fire suppression systems may be provided with the approval of the DFM. Animal research and holding facilities must comply with NFPA 150.

**D. Type of Systems:** All sprinkler systems shall be wet-pipe, except as noted below.

1. Dry systems shall be used when subject to freezing.
2. Antifreeze systems are not permitted.
3. Clean agent systems shall not replace sprinkler systems.
4. Pre-action suppression systems may be considered on a per-project basis with approval by the DFM for selection and use. Single-interlock systems utilizing cross-zoned smoke detectors (e.g., any two detectors) to activate pre-action systems are preferred. Non-interlock pre-action systems are not permitted.

**E. Design Method:** All new systems, new portions of systems, and system upgrades to a higher hazard classification shall be hydraulically calculated. Renovations to existing

calculated sprinkler systems shall be based on the originally calculated pipe sizing, sprinkler spacing, and sprinkler type (all of which must be noted on shop drawings).

#### 9.2.1.1 System Design

**A. Location:** Sprinkler locations shall not be shown on the contract drawings, with the exception of special design areas (e.g., water curtains, aesthetically sensitive areas). Each drawing with any sprinklers shown shall have a note that states “Sprinkler locations shown are for suggested and illustrative purposes only.” Showing sprinklers is also acceptable on demolition plans if a disclaimer note is provided on each such sheet stating, “Sprinkler locations must be verified by the contractor.”

1. Sprinkler locations in special design areas shall be designed by a registered fire protection engineer or a National Institute for Certification in Engineering Technologies (NICET) level III or IV sprinkler designer.
2. Final sprinkler locations shall be coordinated in the field based on NFPA 13 spacing requirements.

**B. Engineering:** Fire sprinkler and standpipe shop drawings and hydraulic calculations shall be sealed by a registered professional engineer experienced in fire protection, or by a NICET level III or IV sprinkler designer.

#### 9.2.1.2 Design Criteria

**A. Calculation:** Hydraulically calculated sprinkler flows for new systems shall be based on the maximum spacing permitted by NFPA 13 (not actual spacing) for all standard spray sprinklers. Calculations in labs and office areas must not use the room design method, quick response area reduction, or omit sprinklers in small rooms and closets.

#### B. Water Supply and Safety Margin:

1. A minimum of a 10% or 69 kPa (10 psi) safety margin (whichever is greater) below the available combined water supply curve shall be provided in the hydraulic calculations of fire protection systems on the Bethesda and Poolesville campuses.
2. The safety factor shall be 15% or 15 psi on the Research Triangle Park, Rocky Mountain Lab, and Ft. Detrick campuses.
3. Water supply for calculations of existing

sprinkler and standpipe systems must be based on an inside flow test.

4. When using pump test data, the safety margin shall be based on the pump discharge pressure. When there is no fire pump, the safety margin shall be based on the hydrant flow test data.
5. Water flow test data for the Bethesda and Poolesville campuses can be provided by the DFM upon request. This flow test data shall be adjusted to the low hydraulic gradient.

### 9.2.1.3 Backflow Preventer

A backflow preventer must be provided for all new sprinkler installations. The backflow preventer shall be selected to minimize friction loss through the device. Incoming fire service backflow preventers shall be American Society of Sanitary Engineering (ASSE) type 1013, 1015, 1047 or 1048 devices (as appropriate) that are also UL listed or FM approved for fire protection service. Where multiple products/manufacturers are permitted in contract documents, the pressure loss used in hydraulic calculations shall not be less than the actual devices as installed. The backflow preventer shall be located downstream of the system isolation valve or post indicator valve (PIV). If the system main drain is not capable of performing a forward flow test in accordance with NFPA 25, provide one 64 mm (2.5 in.) hose valve with National Standard Threads (NST) for every 946 lpm (250 gpm) of system demand. Fire pump test headers may be used as the means when present.

### 9.2.1.4 Drainage

**A. General:** All new sprinkler systems shall have a main drain adjacent to the system riser, fully accessible to maintenance and safety personnel. With the exception of low-point and auxiliary drains that are not required to be piped per NFPA 13, all new system drains shall be piped to the building sanitary sewer system. The connection to the sanitary sewer system shall be capable of accepting the full water flow required for maintenance and testing activities without causing property damage, pooling water, or any other safety hazard. Discharge of sprinkler system drains to the exterior of the building shall not be permitted.

### 9.2.1.5 Materials and Equipment

**A. Type:** Quick-response sprinklers shall be used

throughout all NIH Bethesda facilities except where prohibited by code. Residential listed sprinklers shall be used in sleeping rooms of new and renovated systems. Flow control (on/off) sprinklers are not permitted.

#### B. Special Sprinklers:

1. In areas with ceilings requiring penetrations to be sealed (e.g., water wash down areas, clean-rooms), quick-response gasketed concealed sprinklers shall be provided.
2. In areas that require positive pressure in the ceiling with respect to the areas below, sprinklers shall be listed for this situation or pipe drops must be extended through the ceiling and adequately sealed.
3. In primate areas, or multiple use areas subject to primate occupancy, sprinklers shall be institutional type.

**C. Temperature Rating:** The sprinkler temperature rating shall be ordinary temperature in accordance with NFPA 13 for all NIH facilities/occupancies except for the following:

1. High temperature sprinklers rated at 141°C (286°F) shall be used within 10 feet horizontally of autoclave. This extends to adjacent rooms with non-self-closing doors.
2. High temperature sprinklers rated at 141°C (286°F) shall be used in mechanical rooms, electrical rooms, electrical switchgear and transformer rooms, electric closets, local area network (LAN) rooms, cage wash rooms, and any other areas in which high temperatures are routinely experienced.

**D. Guards:** Sprinklers located within 2.1 m (7 ft.) of the finished floor or subject to damage shall be provided with listed sprinkler head guards in accordance with NFPA 13.

**E. Elevator Machine Rooms and Hoist Ways:** For elevator machine room and elevator hoist way requirements, see [Section 4.7](#).

#### F. Pipe Material:

1. Sprinkler pipe shall be schedule 40 black steel. Schedule 5, schedule 10, and “light wall”-designated sprinkler pipes are not permitted.

2. Where non-ferrous materials are required, copper pipe may be used.
3. Listed flexible sprinkler drops are permitted, if substantiated by hydraulic calculations.
4. Other materials as approved by DFM.

#### G. Pipe Fittings:

1. Fittings that use steel gripping devices or set screws to bite into the pipe when pressure is applied are not permitted.
2. Copper pipe must be joined with brazed fittings only.
3. For modifications of existing galvanized pipe, only threaded or cut grooved joining methods shall be used. Welding is not permitted on galvanized pipe.
4. Where sprinklers are installed on exposed piping, fittings to which sprinklers are connected shall have 25 mm (1 in.) outlets.

#### 9.2.1.6 Installation

**A. Freeze and Mechanical Protection:** All fire service mains shall be adequately protected from freezing and mechanical damage by proper burial depths in accordance with NFPA 24, with the exception of the NIH Bethesda, Fort Detrick and NIHAC Poolesville campuses, which shall have a minimum of 1.2 m (4 ft.) burial depth. Heat trace tape is not permitted, unless approved by the DFM.

**B. Painting:** All new concealed piping and piping in stairwells, storage rooms, mechanical rooms, and utility rooms shall be painted red enamel. All other new exposed piping (outside the stairwells) shall be painted to match the existing ceiling, and red enamel bands 102 mm (4 in.) wide shall be painted at 3,000 mm (10 ft.) intervals. In aesthetically sensitive areas, new exposed sprinkler piping may be painted to match the existing ceiling without red enamel bands where approved by DFM.

**C. Control Valve Location:** Control valves for wet pipe systems shall be located below the ceiling and a maximum of 2,300 mm (92 in.) above the floor. For existing buildings where this requirement cannot be met, consult with the DFM and provide a 460 mm × 460 mm (18 in. × 18 in.) minimum access hatch.

**D. Service Valve Type:** When a dedicated fire protection service is provided, the required isolation valve in the exterior water supply main shall be a lockable PIV.

**E. Sprinkler Clearance:** Sprinkler clearances to obstructions, including shelving, shall be in accordance with NFPA 13. New and relocated sprinklers shall also meet all of the following requirements:

1. Not be located directly above shelving or peninsulas.
2. Located no more than half the maximum allowable distance from the center of peninsulas.
3. Where possible, located at least 30 inches from walls and peninsulas to minimize the chance of future shelving and equipment obstructing sprinklers.

**F. Unused Piping:** During sprinkler renovations, remove and plug all unused pipe in the work area back to the main or branch line. Where feasible, remove unused pipe outside the work area.

**G. ITE Rooms:** Control valves required by NFPA 13 and NFPA 75 for information technology equipment (ITE) rooms or ITE areas shall be provided when the room or area exceeds 200 square feet. The valves shall be located outside the ITE room or area and shall be monitored by the fire alarm system. A separate water supply feed and fire alarm zone are not required for this control valve.

## 9.2.2 Standpipe Systems

**A. Interior Class I Standpipe:** An interior Class I standpipe system shall be provided in facilities with two or more stories above grade or more than one story below grade, except for the 15 group Quarters Buildings. Stairway hose connections shall be located on the stairwell main floor landings and in accordance with the IBC and NFPA 14.

**B. Protection:** Standpipes shall be provided and maintained in accordance with the IBC and NFPA 241 during new construction, demolition, modifications, renovations, and alterations of existing NIH facilities.

**C. Manual Standpipe System Design:** Calculations shall be performed to show that the minimum design flows



required by NFPA 14 can be achieved at a minimum residual pressure of 689kPa (100 psi) at the most remote hose valve with a flat supply pressure of 1,034 kPa (150 psi) at the fire department connection.

**D. Automatic Standpipe System Design:** Where automatic standpipe systems are required per NFPA 14, these systems shall be hydraulically designed (including the design characteristics of the fire pump) to provide a residual pressure on the outlet side of the fire hose connection of the most remote DN 65 (NPS 2-1/2) inch hose connection of 448 kPa (65 psig) at system flow rates determined in accordance with NFPA 14. Automatic standpipe systems shall also be designed to meet the manual standpipe design criteria in the preceding paragraph.

### 9.2.2.1 Standpipe System Materials and Equipment

#### A. Pipe Material:

1. Standpipe shall be schedule 40 black steel. Schedule 5, schedule 10, or “light wall” designated pipe is not permitted.
2. Where non-ferrous materials are required, copper pipe may be used.
3. Other materials as approved by DFM.

#### B. Pipe Fittings:

1. Fittings that use steel gripping devices or set screws to bite into the pipe when pressure is applied are not permitted.
2. Copper pipe must be joined with brazed fittings only.
3. For modifications of existing galvanized pipe, only threaded or cut grooved joining methods shall be used. Welding is not permitted on galvanized pipe.

### 9.2.2.2 Standpipe System Installation

**A. Freeze and Mechanical Protection:** All fire service mains shall be adequately protected from freezing and mechanical damage by proper burial depths in accordance with NFPA 24, with the exception of the NIH Bethesda and NIHAC Poolesville campuses, which shall have a minimum of 1.2 m (4 ft.) burial depth. Heat trace tape is not permitted, unless approved by the DFM.

**B. Painting:** All new concealed piping and piping in stairwells, storage rooms, mechanical rooms, and utility rooms shall be painted red enamel. All other new exposed piping (outside the stairwells) shall be painted to match the existing ceiling, and red enamel bands 102 mm (4 in.) wide shall be painted at 3,000 m (10 ft.) intervals. In aesthetically sensitive areas, new exposed sprinkler piping shall be painted to match the existing ceiling without red enamel bands where approved by DFM.

**C. Control Valve Location:** Control valves shall be located below the ceiling and a maximum of 2,337 mm (92 in.) above the floor. For existing buildings where this requirement cannot be met, consult with the DFM and provide a 457 mm × 457 mm (18 in. × 18 in.) minimum access hatch. New standpipe riser isolation valves shall be located in fire-rated stairways, where possible.

**D. Service Valve Type:** When a dedicated fire protection service is provided, the required isolation valve in the exterior water supply main shall be a lockable PIV.

**E. Drainage:** All new standpipe systems shall have a main drain adjacent to the system riser that is fully accessible to maintenance and safety personnel. With the exception of low-point and auxiliary drains that are not required to be piped per NFPA 13 and NFPA 14, all new system drains shall be piped to the building sanitary sewer system. The connection to the sanitary sewer system shall be capable of accepting the full water flow required for maintenance and testing activities without causing property damage, pooling water, or any other safety hazard. Discharge of standpipe system drains to the exterior of the building shall not be permitted.

## 9.2.3 Fire Hydrants

**A. New Hydrants:** The installation of all new hydrants shall conform to NFPA 24 except as modified below.

**B. Location:** A minimum of two hydrants shall be provided within 152 m (500 ft.) of each building. All hydrants shall be located 12 m (40 ft.) minimum away from the building they are intended to protect. See Section 9.4.3 [Fire Extinguishers](#) for fire department access requirements.

**C. Type:** All fire hydrants shall be UL listed or Factory Mutual approved and shall be of the dry barrel type. The hydrants shall have two 62 mm (2.5 in.) hose outlets and

one 114 mm (4 1/2 in.) pumper connection with National Standard Fire Hose Threads in accordance with NFPA 24, Private Fire Service Mains and Their Appurtenances, and NFPA 1963, Screw Threads and Gaskets for Fire Hose Connections.

**D. Installation:** All hydrants shall be installed adjacent to paved areas between 914 mm (3 ft.) and 2.1 m (6 ft. 11 in.) from the roadway shoulder or curb line, where they shall be readily accessible to fire department apparatus. Hydrants shall be installed with a 152 mm (6 in.) minimum connection to the supply main and shall be valved at the connection.

**E. Roadway Valves:** Roadway valves shall be located between 914 mm (3 ft.) and 1.5 m (5 ft.) from the hydrant.

**F. Painting:** All fire hydrants shall be painted red.

### 9.2.4 Fire Department Connections (FDCs)

**A. Location:** All FDCs shall be on the street side of the building within 30 m (100 ft.) of a fire hydrant and along a walkable path of travel around all obstructions. FDCs shall be located so that exits and exit discharge paths are not obstructed by connected hose lines. FDCs shall not be on loading docks, behind parking spaces, or in other locations subject to being obstructed.

**B. Number:** Buildings with a perimeter exceeding 180 m (600 ft.) and all high-rise buildings must be provided with a second remote FDC accessible from a second fire hydrant.

**C. Type:** All FDCs shall be equipped with 64 mm (2.5 in.) inlets, NST internal threaded swivel fittings, and plugs. Plastic breakaway caps are not permitted. The aggregate number of inlets on each building shall be one for every 250 gpm of system demand. Alternate FDC types shall be provided when required by the local fire department.

**D. Signage:** In addition to the sign plate with raised/embossed lettering required by NFPA 13 and 14, comply with the following:

1. Provide a fixed sign above the FDC and visible from the street, with “FDC” letters that are 15

cm (6 in.) high, 13 mm (0.5 in.) stroke and 38 mm (1.5 in.) from the sign edge or border.

2. The sign must contain sprinkler and/or stand-pipe symbols per NFPA 170, as appropriate.
3. The sign must indicate the highest demand pressure required at the FDC if greater than 150 psi.
4. The sign must be reflective, weather-resistant, and rust-proof.
5. For FDCs feeding a portion of a building or multiple connected buildings, the sign shall include a diagram showing the portion or area fed by the corresponding FDC.
6. For free-standing FDCs, the sign must be on a post behind the FDC and must also indicate the building it feeds.
7. If the sign above the FDC is not visible from the street, an additional FDC sign shall be located on the street side of the building and shall indicate the location of the FDC with a directional arrow.

### 9.2.5 Fire Pumps

**A. Installation:** Only electrically driven fire pumps shall be installed and shall be connected to an emergency power system, if available. See [Section 10.3 Emergency Power](#).

**B. Test Header:** The fire pump test header shall be piped to the exterior of the building.

**C. Flow Meters:** Flow meters are not permitted.

**D. Drainage:** All new drain piping associated with fire pumps shall be piped to the building sanitary sewer system. The connection to the sanitary sewer system shall be capable of accepting the full water flow required for normal operation, maintenance and testing activities without causing property damage, pooling water, or any other safety hazard. Discharge of fire pump system drains to the exterior of the building shall not be permitted.

# Section 9.3

## Fire Alarm and Mass Notification Systems

---

### Contents:

#### 9.3.0 Introduction

#### 9.3.1 Fire Alarm Systems

##### 9.3.1.1 Initiating Devices

##### 9.3.1.2 Notification Signals

##### 9.3.1.3 Notification Devices

##### 9.3.1.4 Trouble Signals

##### 9.3.1.5 Circuit Performance

##### 9.3.1.6 Circuit Voltage

##### 9.3.1.7 Wiring

#### 9.3.2 Fire Alarm System Installation

##### 9.3.2.1 Control Panels

##### 9.3.2.2 Conduit

##### 9.3.2.3 Boxes

##### 9.3.2.4 Exposure

##### 9.3.2.5 Painting

##### 9.3.2.6 Battery Backup

#### 9.3.3 NIH Bethesda Campus Mass Notification Requirements

## 9.3.0 Introduction

The following design requirements apply to fire alarm and mass notifications systems. Provision shall be made for future expansion as determined by the NIH on a project-by-project basis.

### 9.3.1 Fire Alarm Systems

**A. General:** A fire alarm system shall be provided for all facilities. For systems on the Bethesda campus, the fire alarm systems shall be integrated with the mass notification system. Facilities smaller than 186 m<sup>2</sup> gross (2,000 ft<sup>2</sup>) may be exempted with prior written approval of the DFM.

**B. Existing Fire Alarm Reporting System:** The building fire alarm system shall be capable of transmitting an addressable signal over the existing fire alarm reporting system.

**C. Network Control Centers:** New fire alarm initiating devices, as well as modifications to existing initiating devices, will require programming of the Network Control Centers (NCCs). For the NIH Bethesda campus, the NCCs are at the Emergency Communications Center (ECC) in Building 31, the Alternate ECC in Building 10, and the NIH Fire Department in Building 51.

**D. Engineering:** Fire alarm shop drawings and battery calculations shall be sealed by a registered professional engineer experienced in fire protection, or by a NICET level III or IV fire alarm designer.

**E. Other Requirements:** See NIH Guide Specification 283111, Digital Addressable Fire Alarm System (<http://orf.od.nih.gov/POLICIESANDGUIDELINES/Pages/FireProtectionSpecifications.aspx>).

#### 9.3.1.1 Initiating Devices

**A. Standards:** Fire alarm initiating devices shall be provided in accordance with NFPA 101 and NFPA 72 requirements except as amended below.

**B. Pull Stations:** In all buildings where a fire alarm system is required, regardless of occupancy type and sprinkler system installation, manual pull stations shall be installed

in accordance with NFPA 72, including at all exterior doors except stair discharge doors.

#### C. Smoke Detection:

1. Provide smoke detection below all raised floors with a depth of 457 mm (1 ft. 6 in.) or greater.
2. In the Bethesda Building 10 complex, provide smoke detectors in every patient sleeping room, exam room, and procedure room in health care and ambulatory health care occupancies where patients can potentially be left unattended. Smoke detectors shall also be provided in corridors that serve such rooms.
3. In other areas, install smoke detectors only where required by codes referenced herein or in mission critical areas.
4. Smoke detectors containing Ra-226 or greater than 10  $\mu$ Ci of Am-241 shall not be used. Notify the Division of Radiation Safety (DRS) if any smoke detectors containing Ra-226 or Am-241 in amounts greater than 10  $\mu$ Ci are found.
5. Special smoke detection systems, such as air sampling systems, must be approved by the DFM.
6. Video image smoke and flame detection is not permitted.

**D. Duct Smoke Detectors:** Duct smoke detectors shall be provided and installed in accordance with NFPA 90A and NFPA 72. They shall be arranged to shut down the associated AHU and initiate a supervisory signal only. IMC requirements do not need to be met.

**E. Label and Access:** Where installed, detectors shall be clearly labeled and access shall be provided for testing and maintenance.

#### 9.3.1.2 Notification Signals

**A. Notification Standard:** The standard notification sequence for the NIH Bethesda campus is a voice evacuation sequence. For other NIH installations covered by this document, the fire alarm notification appliance shall be compatible with the existing system.

**B. Fire Alarm Signal:** Upon an alarm, the speakers are to sound a “slow-whoop” signal for four cycles followed by a voice evacuation message. Upon completion of the voice message, the slow-whoop shall resound and continue until the fire alarm control panel is reset or the “alarm silence” function is activated. Visual appliances shall remain activated upon alarm silence. All NIH Bethesda campus buildings except for Building 10 shall use the Simplex NIH Bethesda campus, Maryland message with female attention and female order.

### 9.3.1.3 Notification Devices

Fire alarm notification appliances shall be provided in accordance with NFPA 101 and NFPA 72 requirements, except as modified below:

1. Strobe only in operating rooms and restrooms.
2. Speaker only in darkrooms and laser labs.
3. Notification appliances shall not be provided in elevator cabs or exit stairs.
4. Rooms not normally occupied, as listed below shall be equipped with audible/visible notification appliances.
  - i. LAN rooms
  - ii. Mechanical, electrical equipment, and similar rooms greater than 9.3 m<sup>2</sup> (100 ft<sup>2</sup>)
5. Environmentally controlled rooms, such as cold boxes, with workstations shall be equipped with audible/visible notification appliances.
6. All work areas shall have at least one audible/visible notification appliance except private work areas and areas with an occupant load of one person.
7. Audible or visual devices may be omitted if necessary due to animal sensitivity.

### 9.3.1.4 Trouble Signals

All trouble signals on fire alarm systems shall be equipped with a two-minute time delay such that all trouble signals are transmitted to the NCCs between 120 and 200 seconds after onset of the trouble condition.

### 9.3.1.5 Circuit Performance

Fire protective signaling systems shall have the following circuit performance in accordance with NFPA 72:

1. All signaling line circuits (SLCs) shall meet Class A requirements.
2. All panel-to-panel communication SLCs shall meet Class X requirements.
3. All initiating device circuits (IDCs) shall meet Class A requirements.
4. All notification appliance circuits (NACs) shall meet Class A requirements.

### 9.3.1.6 Circuit Voltage

Fire alarm notification circuits shall use a 70 V RMS amplifier circuit or match existing system standards.

### 9.3.1.7 Wiring

**A. Wiring Standards:** On the Bethesda campus, the wires should match the building standard or follow wire standards below:

1. **SLC:** Blue twisted shielded #16 American wire gauge (AWG) or per manufacturer’s requirements.
2. **Speakers:** Yellow twisted shielded #16 AWG or per manufacturer’s requirements.
3. **Strobes:** Red solid copper #14 AWG or per manufacturer’s requirements.
4. The fire alarm wire for 120 V AC circuits shall be solid copper #12 AWG.
5. Door holders shall be connected with solid copper #14 AWG at minimum.
6. Fire alarm conductors shall be solid copper type. Strand wire is not permitted for new installations.

**B. Color Coding:** All field wiring shall be color-coded and reflected on the system shop drawings and as-built drawings.

**C. Splicing:** Splices are not permitted unless approved by the DFM. Where splices are permitted, the terminal strip must be in the same room as the device. The fire alarm backbox shall be labeled to indicate the splice location.

## 9.3.2 Fire Alarm System Installation

### 9.3.2.1 Control Panels

New fire alarm control panels shall be installed in the building's main lobby/entrance, unless otherwise approved by DFM, or when a fire command/control room is required by NFPA 101.

### 9.3.2.2 Conduit

In general, fire alarm wiring shall be installed in 19 mm (0.75 in.) minimum rigid conduit or electrical metallic tubing (EMT); a flexible metal conduit may be installed as permitted by NFPA 70. All fire alarm wiring in damp locations (fire pump and valve rooms, at flow and tamper switches) shall be installed in liquid-tight flexible metal conduit and liquid-tight device boxes. Flexible metal conduit is limited to 1.8 m (6 ft.) and shall be secured per NFPA 70.

### 9.3.2.3 Boxes

The electrical back boxes for notification appliances for the Building 10 complex shall be 89 mm (3.5 in.) deep, 102 mm (4 in.) square junction boxes with flat vertical bracket, five 13 mm (1/2 in.) and five 13 mm (1/2 in.) to 19 mm (3/4 in.) side knockouts, and two 13 mm (1/2 in.) and two 19 mm (3/4 in.) bottom knockouts or equivalent. The electrical back box shall be a single box. Extension rings are not permitted.

### 9.3.2.4 Exposure

In areas subject to the elements, such as high humidity and temperature differences, or moisture (e.g., building exteriors, parking garages, rooms subject to steam discharge, cage wash areas, cold boxes, and environmentally controlled rooms):

1. Fire alarm initiating devices and notification

appliances shall be weatherproof with weatherproof back boxes and seal-off fittings installed in accordance with NFPA 70.

2. Conduit serving fire alarm circuits shall be EMT with compression fittings, rigid metal conduit, or liquid tight conduit installed in accordance with NFPA 70. The use of flexible metal conduit in these areas is prohibited.

### 9.3.2.5 Painting

All new concealed fire alarm system conduit and fire alarm system conduit located in stairwells, storage rooms, mechanical rooms, and utility rooms shall be painted red enamel. All other new exposed fire alarm conduits (outside the stairwells) shall be painted to match the existing ceiling color, and red enamel bands 102 mm (4 in.) wide shall be painted at 3,000 mm (10 ft.) intervals. In aesthetically sensitive areas, new exposed fire alarm system conduits may be painted to match the existing ceiling without red enamel bands where approved by DFM.

### 9.3.2.6 Battery Backup

Battery backup shall be provided on all fire alarm systems. Standby battery requirements shall include twenty-four hours of standby system supervision and an additional thirty minutes in alarm mode.

In facilities served with an approved secondary power source or emergency generator-powered circuits, a battery system for four hours of standby system supervision and an additional thirty minutes in alarm mode shall be provided.

## 9.3.3 NIH Bethesda Campus Mass Notification Requirements

The mass notification signal inputs shall be retransmitted simultaneously over all building fire alarm notification circuits, including the exterior notification circuit. The exterior notification circuit shall not be arranged to activate with the building fire alarm system. New mass notification nodes, as well as modifications to existing nodes,



will require programming of the Network Voice Control Centers (NVCCs). For the NIH Bethesda campus, the NVCCs are at the Emergency Communications Center (ECC) in Building 31, the Alternate ECC in Building 10, and the NIH Fire Department in Building 51. The mass notification shall be programmed with the following priorities (highest first):

1. Local pre-discharge alerts in area covered by the corresponding suppression systems only
2. Building 31 ECC microphone
3. Building 10 ECC microphone
4. Building 51 microphone
5. Building of incident local microphone
6. Building of incident fire alarm evacuation message
7. Public address transmissions over the building fire alarm speakers

Exterior speakers shall be mounted 3.7 m (12 ft.) above grade and 12.2 m (40 ft.) on center unless permitted otherwise by the DFM. All conduits shall be run internally

within the building wherever feasible. Exterior speaker housing shall be weatherproof. Exterior speakers shall be capable of delivering 4 watts.

**A. Splicing:** Splices are not permitted on the Mass Notification System.

**B. Multiconductor Cable:** The multiconductor cable for the NIH Bethesda fire alarm reporting and mass notification systems is custom fabricated. There shall be no splices and wire runs shall be continuous from terminal panel to terminal panel.

# Section 9.4

## Life Safety Features

---

### Contents:

9.4.0 Introduction

9.4.1 Means of Egress

9.4.2 Fire Department Access

9.4.3 Fire Extinguishers

9.4.4 Smoke Control Systems

9.4.5 Dampers

9.4.6 Emergency Power

9.4.7 In-Building Signal Amplification

## 9.4.0 Introduction

The following highlights life safety requirements in addition to the applicable codes and standards.

### 9.4.1 Means of Egress

Means of egress shall comply with the NFPA 1, NFPA 101, and all referenced standards, as amended below:

1. Loading dock exit door shall not be utilized as a required egress path for areas of the building outside the loading dock area.
2. A minimum 914 mm (3 ft.) of clear aisle space shall be maintained around laboratory benches and furniture.
3. Unlocking of doors in the direction of egress travel solely by the fire alarm system is not permitted.

See Chapter 4 for additional provisions regarding doors and shelving.

### 9.4.2 Fire Department Access

**A. Fire Apparatus Access:** Public roads or fire department access roads (fire lanes) shall be provided in accordance with NFPA 1 as amended below.

1. All new buildings shall have at least two sides readily accessible to fire department apparatus at all times.
2. Access to all fire hydrants and fire department connections must be provided.
3. The road edge closest to the building shall be between 10 and 20 feet from the building.
4. All fire lanes and access areas for fire hydrants and automatic sprinkler/standpipe fire department connections shall have curbs painted yellow and appropriate signs provided.
5. The minimum roadway turning radius shall conform to the standard 15 m (50 ft.) semi-trailer template.

6. Fire lanes shall be constructed of an all-weather driving surface capable of supporting imposed loads of at least 36,287 kg (80,000 lbs).
7. Turf-filled paver blocks are not acceptable as an all-weather driving surface.
8. Signage shall be posted and spaced at 30 m (100 ft.) intervals and/or at the beginning and end of the no-parking zones.

**B. Roof Access:** Every flat roof of a building of two or more stories shall have at least one stairway access.

**C. Key Box:** A fire department-secured key box (Knox Box Model 4400 for NIH Bethesda campus) shall be provided in all new construction for emergency fire department entry. The key box shall be located at the main entrance door of the facility. If any dimension of the building is more than 46 m (150 ft.), then additional key boxes shall be remotely provided. The key shall match other existing secured key boxes.

### 9.4.3 Fire Extinguishers

**A. General:** Fire extinguishers shall be provided per NFPA 101 and located per NFPA 10. Requirements of the IBC do not need to be met. Fire extinguisher and fire extinguisher cabinet submittals shall be reviewed and approved by the NIH Division of the Fire Marshal (DFM) before purchase of the extinguishers and cabinets. Fire extinguishers shall be compatible with Amerex model B456 spare parts. All fire extinguisher cabinets shall be sized to contain the fire extinguisher noted above. When fire extinguishers with an alternate agent are required, provide an appropriately sized cabinet. Fire extinguisher cabinet doors shall not have locks. Cabinets shall have full glass fronts or “Fire Extinguisher” signs outside the door.

**B. Laboratories:** All laboratory fire extinguishers shall be located in the corridors. The maximum travel distance to an extinguisher shall be 15 m (50 ft.). For open labs, the fire extinguisher shall be located as closely as possible to the exit access doors.

## 9.4.4 Smoke Control Systems

**A. Engineering Analysis:** An analysis shall be documented in an engineering report and include an assessment of potential fuels, a fire dynamics analysis that may include fire modeling, and a tenability assessment for the period of occupant egress.

**B. Sequence of Operation:** The sequence of operations of all fire protection systems and HVAC interfaces shall be included.

**C. Field Control Switches:** Field control switches shall be provided, with locations coordinated with the NIH Fire Department.

**D. Acceptance Testing:** Smoke control systems, if provided or being renovated, shall have their method of operation, control mechanisms, and pass/fail criteria for acceptance tests clearly defined.

## 9.4.5 Dampers

**A. Shaft Enclosures:** Shaft enclosures that are permitted to be penetrated by ducts shall be protected by fusible link fire dampers. The use of combination fire/smoke dampers or smoke dampers is prohibited.

**B. Fume/Exhaust Hoods:** Fire dampers shall not be provided on any fume hood system, in any laboratory fume removal exhaust system, or in laboratory hoods per NFPA 45.

**C. Inaccessible Locations:** Motorized fire dampers for inaccessible locations may be approved by the DFM on a case-by-case basis. The dampers shall be provided with an accessible remote testing station with visible indicating lights.

## 9.4.6 Emergency Power

**A. General:** In addition to those required by the Life Safety Code and [Section 10.3 Emergency Power](#), light sources for photo-luminescent exit signs shall be provided with an approved secondary power source.

**B. Generator Available or Planned:** If an emergency generator is available or if emergency circuits for a future planned generator are in place, the following fire protection and life safety systems shall be connected to the emergency circuits (in addition to those required by the Life Safety Code and [Section 10.3 Emergency Power](#)):

1. Exit signage
2. Emergency lighting
3. Fire alarm system
4. Mass notification system
5. Elevator(s) (operate one per bank and transferable)
6. Smoke control system and/or stair pressurization (including controls and fans)
7. Electric fire pump and controller
8. Jockey pump and controller
9. Air compressor serving a fire protection system
10. Fire command center environment (power, lighting, HVAC)
11. Elevator shunt trip power feeds
12. Fire suppression releasing panels
13. Electrically actuated fire dampers
14. In-building signal amplification equipment

**C. Generator Requirements:** Generator installations shall comply with NFPA 110. Provide a manual emergency stop outside each generator to facilitate emergency shutdown.

## 9.4.7 In-Building Signal Amplification

For the NIH Bethesda campus, refer to the latest Montgomery County regulations regarding in-building signal amplification.

# Section 9.5

## BSL-3 and ABSL-3 Biocontainment

---

### Contents:

#### 9.5.0 Introduction

#### 9.5.1 Fire Protection Systems

##### 9.5.1.1 Automatic Sprinkler Systems

##### 9.5.1.2 Fire Alarm Systems

#### 9.5.2 Design Documentation

## 9.5.0 Introduction

The requirements of this section apply to both BSL-3 and ABSL-3 laboratory and animal spaces. The term BSL-3 is utilized generically.

### 9.5.1 Fire Protection Systems

**A. General:** The A/E shall refer to Chapter 2 sections 2.5 and 2.6 and the preceding sections of this chapter and determine the applicable provisions that are to be incorporated into the design of the biocontainment facility.

**B. Coordination:** Fire sprinkler and alarm zones should be coordinated and shall be as approved by DFM.

#### 9.5.1.1 Automatic Sprinkler Systems

**A. Protection Required:** All BSL-3 facilities shall be fully protected with an automatic sprinkler system.

**B. Sprinkler Heads:** Sprinkler heads shall be pendant type and shall not be recessed or concealed.

**C. Chemical Resistance:** Sprinkler head and pipe material and finish shall be resistant to chemicals used during the daily operation of the laboratory and decontamination procedures.

**D. Barrier Penetrations:**

1. Penetration details for sprinkler piping shall meet requirements as described for plumbing penetrations through containment.
2. The piping drop shall extend through the penetration sufficiently to allow for application of a visible seal. Escutcheons shall not be provided; however, a flat, solid stainless-steel plate or washer that is tight fitting against the pipe may be utilized if bedded in sealant and sealed to the pipe circumference.
3. Piping drops shall be rigidly braced to the

structure prior to penetrating the containment barrier to preclude damage to the barrier seal due to piping movement that can occur during events such as system maintenance or impact.

4. Sealant application shall be provided so as to not adversely affect the operation or UL listing requirements of the sprinkler head. See [Appendix L: Sealant Table](#).
5. Sprinkler pipe penetrations at the containment barrier of BSL-3 facilities require mock-ups to be constructed and tested prior to installation. Test criteria shall be that of the room tightness criteria and testing shall be performed as outlined by NIH.
6. Mock-up, seal, and room tightness test requirements for the sprinkler pipe and penetration shall be coordinated with other pipe and conduit penetrations and layout and shall meet the same standards as outlined in [Chapter 8: Plumbing Design](#).

#### 9.5.1.2 Fire Alarm Systems

**A. Notification Appliances:** Install standard notification appliances, to include combination appliances and speakers in all BSL-3 laboratories.

1. **Animal Holding Areas:** Installation of fire alarm notification appliances in animal holding areas should be evaluated on a case-by-case basis with veterinary staff and shall be approved by the DFM.
  - i. In animal study areas that are subject to light restrictions, an interface to the building lighting control systems is permitted in lieu of fire alarm notification appliances such that the animal holding room lighting dims or flashes during a fire alarm activation, where required after consultation with the DFM.

**B. Conduits, Boxes and Sealants:** Comply with the requirements in [Section 10.8](#). See [Appendix L: Sealant Table](#).



## 9.5.2 Design Documentation

**A. General:** In addition to the design documentation requirements mentioned in the preceding sections, provide the following:

1. Sprinkler pipe penetrations at the containment barrier of BSL-3 facilities shall be detailed in the construction documents.
2. Fire alarm conduits penetrations and boxes installation at containment barriers of BSL-3 facilities.

# Chapter 10

---

## Electrical Design

# Section 10.1

## Electrical Systems Design

---

### Contents

- 10.1.0 Introduction
- 10.1.1 System Growth
- 10.1.2 Renovation and Rehabilitation
- 10.1.3 Unusual Electrical System Design
- 10.1.4 Codes and Standards
- 10.1.5 Design Documentation
- 10.1.6 Testing and Operational Requirements

## 10.1.0 Introduction

The objectives of the electrical design guidelines are to establish uniformity of design, achieve the best overall cost-effective installation, and construct an electrical system that is compatible with other building systems. The design of the electrical systems shall meet the program requirements while incorporating NIH's commitment to sustainability and energy-efficiency. The following design requirements apply to all electrical system designs.

---

### 10.1.1 System Growth

Lighting, power, and communication systems requirements may change during the lifespan of a NIH facility requiring many alterations. These systems must have ample capacity to meet future increased load demand and allow for modification in an area without disrupting other areas of a facility. The electrical system design shall include provisions for the addition of future electrical loads as determined by the NIH on a project-by-project basis.

---

### 10.1.2 Renovation and Rehabilitation

**A. General:** Renovation and rehabilitation of existing facilities do not always allow adoption of the latest industry standards. Existing electrical systems may be antiquated or inadequate for the addition of a new electrical load. The newly planned function may be incompatible with the original building design criteria.

**B. Evaluation and Recommendations:** The A/E shall evaluate early in the design stage to determine the feasibility of implementation of the latest standards. The A/E shall document their findings and submit them with their recommendations to the Project Officer (PO).

## 10.1.3 Unusual Electrical System Design

Whenever a proposed electrical system design has any unusual characteristics and the design intent is not easily discernible, the Basis of Design (BOD) and/or the design analysis narrative shall include the reasoning behind the proposed innovative design to ensure that the proposed design is acceptable to the NIH. This document shall be presented at the earliest design stage.

---

### 10.1.4 Codes and Standards

The A/E shall comply with the latest edition of the applicable codes and standards as listed in [Section Chapter 1: Administration](#). In addition, the A/E shall comply with other safety guidelines received from the PO and other relevant guidelines as required by the program.

---

### 10.1.5 Design Documentation

The A/E shall submit drawings, specifications, and calculations at different stages of a project. Refer to [Appendix E: A/E Submission Requirements](#) for documentation requirements at the completion of each stage.

**A. Drawings:** Contract documents shall include the following:

1. Show all service and major feeder conduit routings and large pull boxes. Include one line diagram not computer generated from short circuit study.
2. Panelboard designation, circuit numbers, and switching groups shall clearly be indicated for each electrified device. Drawings shall clearly show where exposed conduits are to be installed, and indicate locations where conduits are to be concealed. As-built drawings shall include circuit homerun locations.
3. A ground riser diagram showing wire sizes, ground bars, and interconnections shall be provided.

4. A lighting fixture schedule on drawings, identifying at least three manufacturers, catalog numbers, lighting circuit voltage, lamp types, ballast/driver type, number of lamps, installation information, description of fixtures, and remarks shall be provided for each fixture type identified as approved equals.

**B. Site Utility Design Drawings:** The drawings shall include section views of all ducts, with identification and labeling used; and section views of the manholes with identification of each side and bottom. The drawings shall show routing of all duct distribution systems, duct sizes, manhole/handhole sizes, cable sizes, feeder numbers, and grounding details of all manholes. All duct penetrations including spares shall be identified and labeled.

**C. Panel Schedules on Construction Drawings:** Schedules shall include all data required to order

the equipment and to identify the attached loads. Information shown shall include:

1. Panel name
2. Number and size of all breakers, including spares
3. Number of bussed spaces and the maximum ampere frame ratings
4. Total number of breaker positions in the panel
5. Bussing ampacity
6. Main circuit breaker (MCB) and rating; or main lugs only (MLO)
7. Surface or recessed mounting
8. Top or bottom feed
9. Proposed location of panel

**Table 10.1.5 Example Calculation of Electrical Load Summary  
Normal Power (or Emergency/Standby Power)**

System voltage	480V, 3 Phase, 4 Wire			
Design power factor with correction	0.97			
Description of Load	Connected Load (kVA)	Load Type <sup>a</sup>	Multiplier	Design Load (kVA)
Lighting	100	C	1.25	125
General power receptacle	100	NC	1.0 <sup>d</sup>	55
Motors	100	M	1.0 <sup>e</sup>	100
Air conditioning	100	NC	1.0	100
Miscellaneous	100	NC	1.0	100
Largest motor	100	M	0.25	25
Subtotal of connected load (kVA)				505
Future load at 25% <sup>b</sup> (kVA)				126
Total design demand load (kVA)				631
Full current (A)				759
Overcurrent device size (A) <sup>c</sup>				1200
Transformer capacity (kVA)				750

<sup>a</sup> Definition of load types: C = continuous; NC = non-continuous; M = motor.

<sup>b</sup> Refer to sections 10.2 and 10.3 for future load growth requirements.

<sup>c</sup> Refer to National Electrical Code for 100% rated overcurrent device requirements.

<sup>d</sup> Apply 100% demand factor for first 10 kVA of receptacle load and 50% for remainder over 10 kVA.

<sup>e</sup> Demand factor shall be zero for any redundant motor when such motor is not scheduled to operate simultaneously.

10. Trip rating, frame rating, and number of poles of each breaker
11. Short circuit interrupting rating of the panel
12. Identification of the load and room number
13. Estimated connected load in volt-amperes (VA; or kilovolt-amperes [kVA]) per circuit (in watts [W] or kilo watts [kW] for generator loads)
14. Panel total connected kVA and amperes (A) (in W or kW for generator loads)
15. Panel total demand kVA and A (in W or kW for generator loads)

**D. Calculation and Analysis:** The following design calculations and analyses shall be provided:

1. Economic analysis for justification of selection of either 120/208 V or 277/480 V on the secondary side of the network distribution transformers
2. Analysis to determine if large central or smaller 120/208 V step-down transformers are to be used. An economic analysis shall be performed if the choice is not obvious.
3. Electrical service sizing shall be based on the National Electrical Code (NEC) and the *DRM*, as well as estimated connected and demand for major electrical distribution equipment loading, including an additional capacity (minimum 25%) for future building loads. Separate load summaries shall be prepared for both normal and standby/emergency power as shown in the load analysis example given in [Table 10.1.5](#).
4. Panelboard load summation for justification of distribution equipment sizing
5. Transformers, uninterruptible power supply (UPS), and generator sizing calculations
6. Voltage drop calculations for branch circuits longer than 20 m (65 ft.) at 120 V, and branch circuits and feeders longer than 38.1 m (125 ft.) at 208 V, longer than 45.7 m (150 ft.) at 277 V or higher
7. Initial short circuit analysis determining the interrupting or withstand rating of the system components and justification for selection of distribution equipment. Final short circuit analysis shall be performed by the distribution equipment manufacturer based on the actual distribution equipment proposed for installation.
8. Coordination study determining the circuit breaker settings and system coordination. Final coordination study shall be provided by the distribution equipment manufacturer.
9. Arc flash study for all new electrical distribution equipment
10. Cable-pulling calculations to ensure that the maximum tension or sidewall pressures are not exceeded
11. Underground duct bank heating calculation for ambient de-rating of cables
12. Electrical system harmonic load flow analyses for variable frequency drive (VFD) application
13. Lighting calculations giving illumination levels in lux as well as foot candle (fc). Point by point calculations shall be provided for each typical room type and for rooms with unique lighting arrangements. Lighting calculation submittal shall include the lighting fixture manufacturer's name, the lighting fixture catalog number, the average illumination level, the light loss factor use, and the maximum to minimum illumination ratio. Include ASHRAE 90.1 compliance for each area based on room function.

**E. Power Systems Study:** Perform a power system study prior to ordering the equipment. General requirements of the study are as follows:

1. **General:** The study shall include executive summary, assumptions, short circuit study results with a summary of PASS or FAIL at each bus based on the available short circuit currents and commercially available short circuit rating, load flow study results, motor-starting study results, feeder voltage drop calculations, and conclusions. The study shall include all portions of the electrical distribution system from all power source(s) including the smallest adjustable trip circuit breaker in the distribution system.



System connections that result in maximum fault conditions shall be adequately covered in the study.

2. **Credentials:** Power system study shall be performed, stamped, and signed by a registered professional engineer, with a minimum of five years of experience in power system analysis. Credentials of the firm/individuals shall be submitted to the PO for approval prior to the start of the work.
3. **Submission:** The A/E shall provide hard copy reports and all electronic files, SKM or similar software project files, associated with the power system study showing corresponding bus and cable run identification numbers corresponding to the calculations; system load calculations for switchgears, switchboards, motor control centers (MCCs), panelboards, busways, risers, and transformers; and products specified in the design.
4. **Equipment Ordering:** The power system study shall be performed using NIH-approved software and shall be submitted to the PO prior to receiving final approval of the distribution equipment shop drawings and/or prior to release of equipment for manufacturing. If formal completion of the study would cause delay in equipment manufacturing, approval from the PO may be obtained for a preliminary submittal with sufficient study data to ensure that the selection of device ratings and characteristics will be satisfactory.

## 10.1.6 Testing and Operational Requirements

**A. Specifications:** The A/E shall incorporate the following in the project specifications:

1. Testing and operational training requirements
2. Startup and checkout of building systems

**B. Operation and Maintenance Manuals:** Provide operation and maintenance (O&M) manuals for all electrical equipment supplied on the project, in both hard copy and electronic formats on a CD-ROM, DVD, etc. Scanned items are acceptable.

**C. Power Distribution Acceptance Testing:** Perform acceptance testing of primary cable, primary switches on network transformers, network protectors, secondary switchgear, power circuit breakers, motor control centers (MCCs), grounding system, generators, and transfer switches in accordance with the latest edition of ANSI/NETA or NICA acceptance testing specifications. Acceptance tests shall include all other tests recommended by the equipment manufacturer.

The minimum tests required for the given equipment are shown in [Table 10.1.6](#).

**Table 10.1.6 Tests Required for Electrical Equipment**

<b>Equipment</b>	<b>Test</b>
Medium voltage cable	Insulation resistance
Medium voltage oil switch	Visual; contact resistance; insulating liquid
Network transformer	Visual; AC high-potential test on primary windings and switch; insulation resistance (2500 V Megger) on primary and secondary windings; turns ratio on all tap positions; insulating liquid Envirotemp FR3 oxygen percentage; FR3 (six individual tests) including dielectric breakdown voltage
Network protector	Visual and mechanical; insulation resistance Current transformer ratio; contact resistance Minimum pickup voltage
Secondary switchgear	Visual and mechanical; insulation resistance High potential; instrument transformers
Power circuit breaker	Visual and mechanical; insulation resistance Pickup and time delay values; operation
Motor control centers	Visual and mechanical; insulation resistance Overload; bus and starters
Grounding electrode	Fall of potential
Ground fault	Visual and mechanical; neutral to ground resistance; pickup and time delay
Generator	Visual and mechanical; insulation resistance Protective relay; phase rotation
Automatic transfer switches	Visual and mechanical; contact resistance; insulation resistance; relay settings; timer settings; operation

# Section 10.2

## Electrical Service and Normal Power

---

### Contents

10.2.0 Introduction

10.2.1 Electrical Power Distribution

10.2.2 Electrical Service

10.2.2.1 Medium Voltage Service Equipment

10.2.2.2 Secondary Voltage Service Equipment

10.2.3 Motor Control

10.2.4 Electrical Work Space

10.2.5 Other Requirements

## 10.2.0 Introduction

Electrical service shall be adequate to support the current electrical and future anticipated load without compromising reliability. The A/E shall evaluate the degree of reliability required. Design issues such as separately routed primary feeders, two versus multiple network transformers, transformer placement, and switchgear location influence reliability. Critical installation may also require installation of on-site electric power generation. Refer to the [Section 10.3 Emergency Power](#), for requirements/guidance on emergency power.

### 10.2.1 Electrical Power Distribution

**A. Bethesda Campus:** Building electrical service at the Bethesda campus typically employs three network transformers as shown in [Figure 10.2.1\(A\)](#). A few of these buildings employ a non-network transformer in addition to three network transformers as shown in [Figure 10.2.1\(B\)](#). Other remaining buildings are served from a single dedicated pad mounted transformer as shown in [Figure 10.2.1\(C\)](#). With NIH acceptance and proper justification by A/E design team, double-ended stations can be used to supply power to select buildings.

Note that facilities fed from single pad mounted transformers in lieu of the spot network system shall be provided with electronic main circuit breakers.

**B. Other Locations:** Building electrical service at locations other than the Bethesda campus shall consider the following:

1. **Systems Architecture:** The following systems are listed in terms of increasing flexibility, reliability, and cost.
  - a. Looped primary
  - b. Radial primary
  - c. Primary selective
  - d. Primary selective and secondary selective
  - e. Network

For new construction, when continuity of service is critical, network transformers shall be considered as the first priority.

2. **Primary selective and secondary selective:** If a “primary selective and secondary selective” system is chosen with project officer’s (PO’s) approval (when network transformers are not feasible), secondary selective system may consist of the following:
  - a. Multiple primary feeders
  - b. Multiple fused load interrupter switches
  - c. Multiple transformers
  - d. Multiple secondary main breakers
  - e. Tie breaker(s)
  - f. Feeder breakers as required
  - g. Programmable logic control for switching and interlock

**C. Service Voltage:** The secondary service voltage selection will depend on the electrical load. The preferred secondary voltage is 480/277 V. A building with an electrical demand load of 750 kVA or less could operate on 208/120 V unless there are compelling reasons to operate at 480/277 V. An economic analysis to determine the best choice of voltage rating should be undertaken when the decision is unclear. Refer to [Table 10.2.1](#) for a listing of standard voltages and their applications.

*Rationale: This is to ensure that electrical system construction and operational cost is consistent with system size.*

**D. Spare Capacity:** Size the electrical distribution equipment with minimum spare capacity as shown below:

1. **Main Switchgear:** 25% spare ampacity and 25% spare feeder circuit capacity
2. **Switchboards and Distribution Panels:** 25% spare ampacity and 25% spare circuit capacity
3. **Branch Circuit Panelboards:** 25% spare ampacity and 25% spare circuit capacity

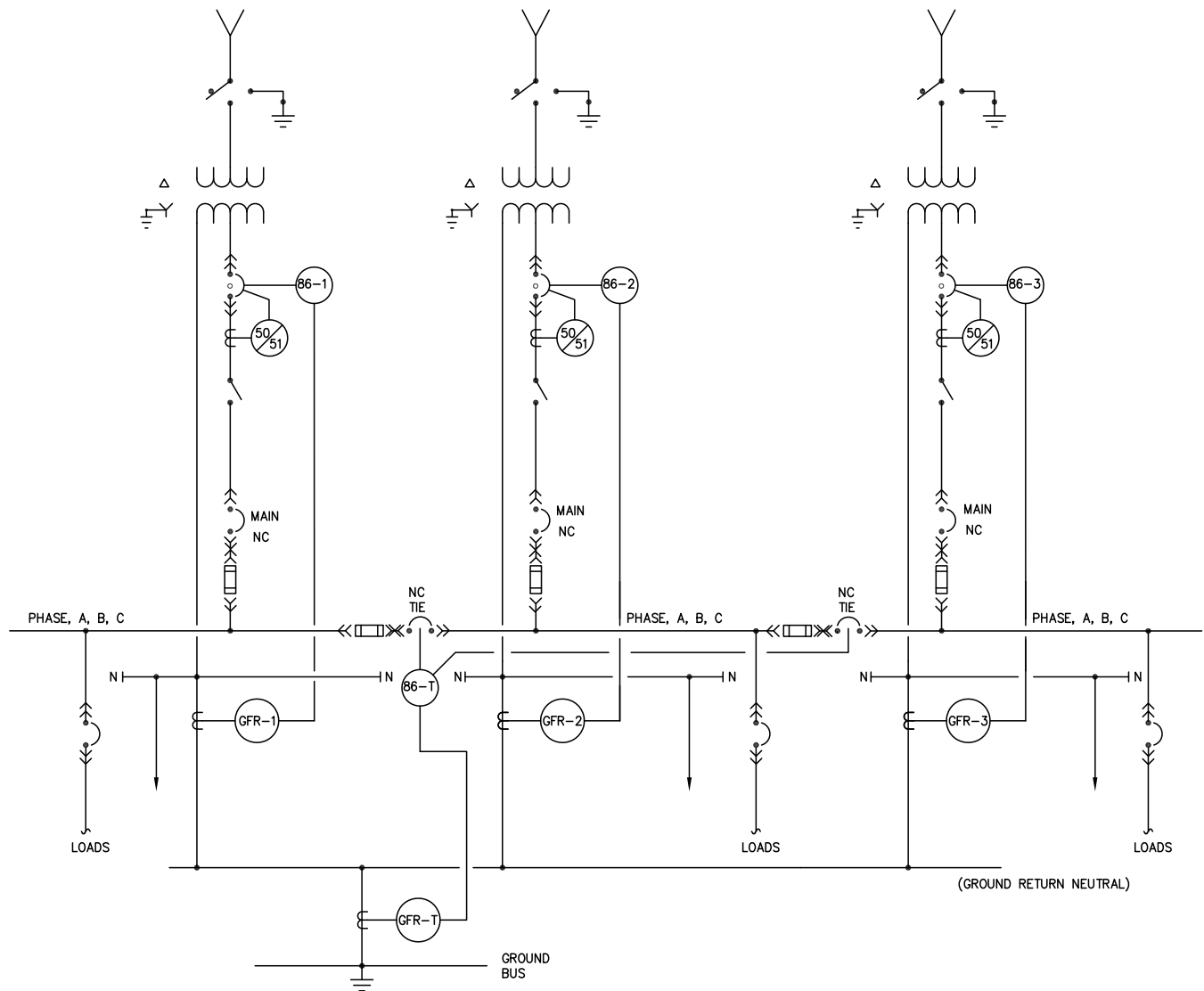
**Figure 10.2.1(A) Typical building service (three transformers) – normal power**

**E. Interrupting Capacity:** Provide electrical equipment with bus bracing and device interrupting capacities that exceed the available fault current at the terminals.

**F. Selective Coordination:** Provide fully selectively coordinated overcurrent protection to the extent practical (use a molded case switch at the downstream protective device when the upstream protective device is of the same size to allow full coordination). Where ground fault protection is provided for the main circuit breakers, provide ground fault protection for feeder circuit breakers to have selective tripping of the breaker closest to the fault.

**G. Power Quality:** Design power systems in accordance with recommended design practices in The Institute of

Electrical and Electronics Engineers (IEEE) standard 1100 and IEEE standard 141. Mitigate harmonic distortions generated by an individual load with filtering at the load terminal to limit harmonic distortions at the electrical system. Limit harmonic distortion at the load side of the building primary transformer not to exceed the limits set for the point of common coupling per IEEE Standard 519. Refer to [Section 10.6 Power Quality and Grounding](#).

**H. Load Segregation:** Wherever possible, loads shall be segregated into like groups based on function (i.e., office, mechanical, research, etc.) or type of load (i.e., computers, motors, lighting, receptacles, etc.).

**Figure 10.2.1(B) Typical building service (four transformers) – normal power  
(Fourth transformer is for emergency power)**

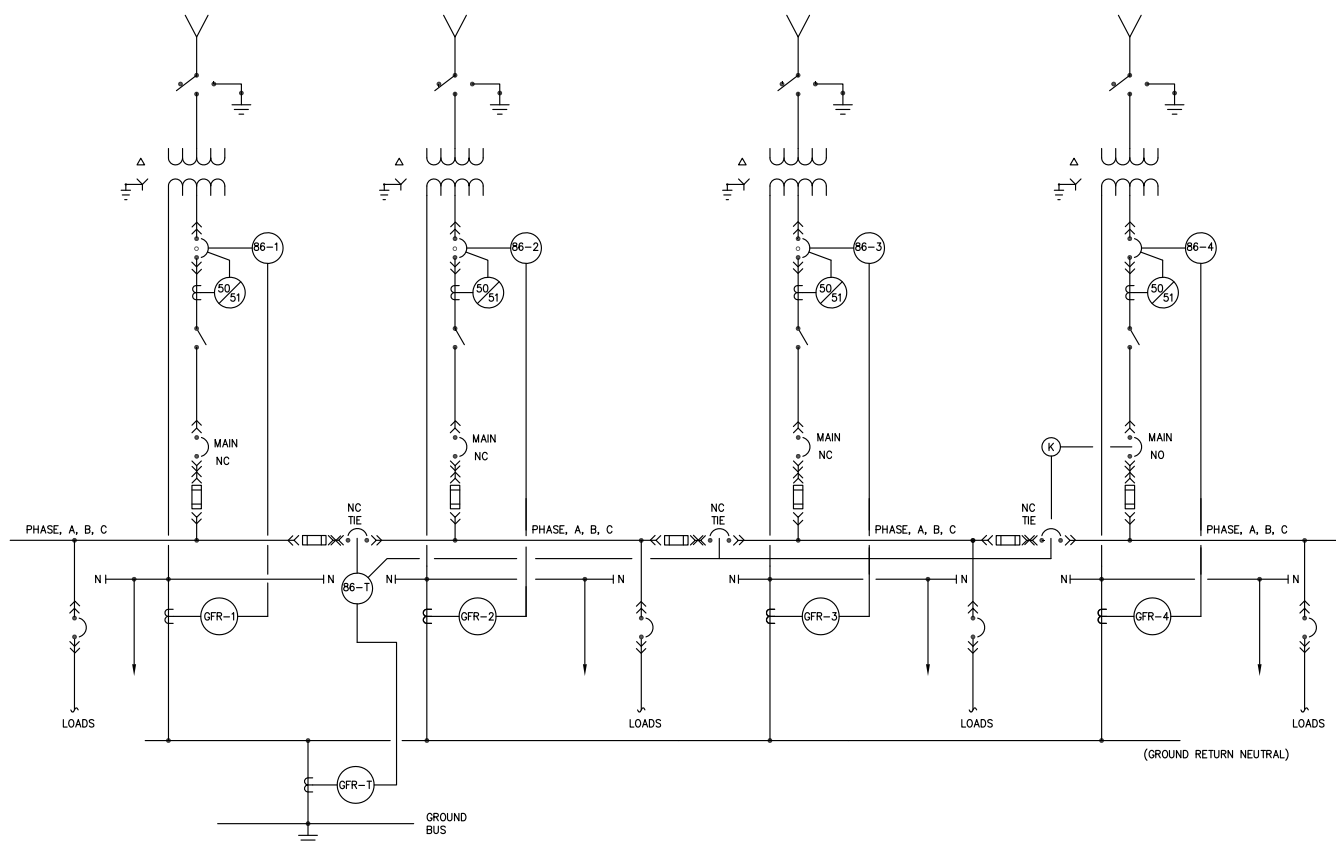

**Rationale:** This is to increase reliability of the electrical service and limit disruption of electrical service to similar types of electrical loads.

**I. Utilization Voltage:** The standard voltages for different utilization equipment shall comply with the following requirements:

1. **Lighting:** The standard voltages for lighting systems are as follows:

- Fluorescent or HID lamps – 277 V (120 V when 277 V source is not available)
- Incandescent lamps (when allowed) – 120 V
- Light Emitting Diode Lamps – 120 or 277 V

2. **Electric Heating (When Allowed):** The standard voltages for an electric heating system are as follows:

- Less than 1.5 kW: 120 V, 1-phase

- Between 1.5 kW and 3 kW: 208 V or 480 V, 1-phase

- Above 3 kW: 480 V, 3-phase or 208 V, 3-phase only if 480 V is not available

**Note:** Use of electric power for total heat production exceeding 3 kW for a space is not permitted unless a formal written variance request for such use is approved by the Division of Technical Resources (DTR).

3. **Motors:** The standard voltages for motors are as follows:

- 250 W (1/3 hp) or below: 120 V, 1-phase
- 370 W (1/2 hp): 208 V or 480 V, 1-phase or 3-phase
- 560 W (3/4 hp): 208 V or 480 V, 3-phase
- 2.2 KW (3 hp) or above: 480 V, 3-phase, or 208 V 3-phase only if 480 V is not available.



**Note:** Motors shall be rated 115/120 V for 120 V systems, 200/208 V for 208 V systems, and 460/480 V for 480 V systems (other nominal voltage and corresponding rating for motors are possible based on availability of utilization of voltage at the project location). Single phase motors furnished as integral parts of variable air volume terminal units are acceptable for all horsepower (hp) ratings.

***Rationale:** Efficiencies of single phase motors are less than three-phase motors. In addition, single phase operation demand higher current and require larger conductors, increasing both construction and operational cost.*

**Figure 10.2.1(C) Typical building service (two transformers) – normal power**

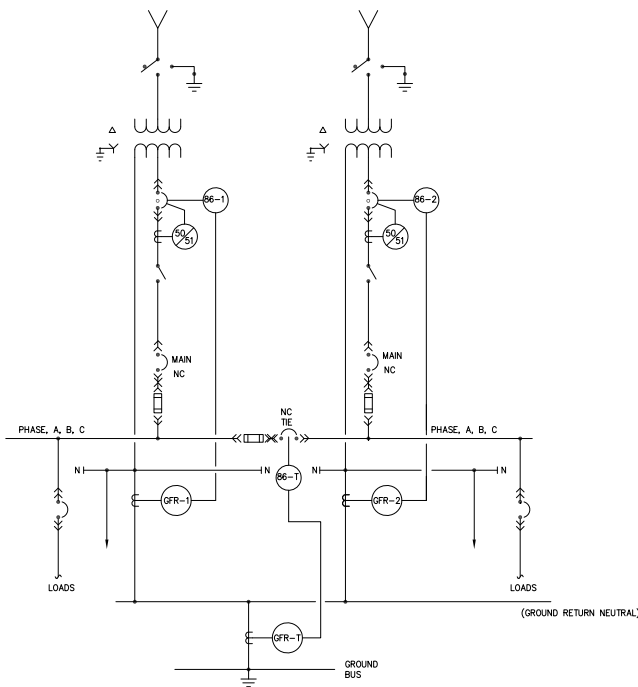

**Figure 10.2.1(D) Typical building service (single transformer) – normal power**

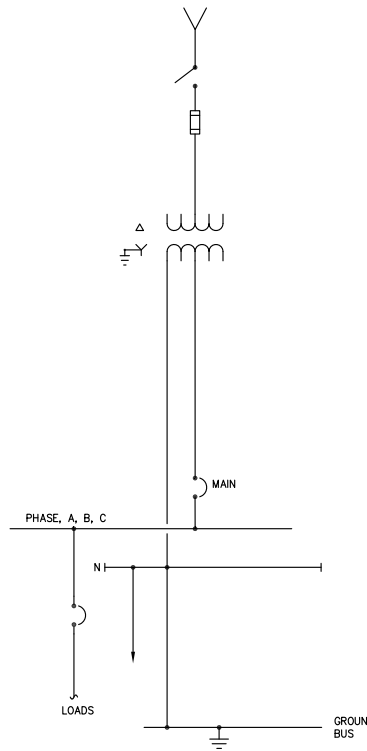

**Table 10.2.1 Standard Voltages and Applications**

Voltage	Phase	Wire	Description
13.8 kV	3	3	Primary voltage
4160/2400 V	3	4	Large motor voltage, utility plant only
480/277 V	3	4	Preferred secondary voltage
208/120 V	3	4	Optional secondary service voltage and receptacle utilization voltage

## 10.2.2 Electrical Service

**A. Coordination:** New service may require installation of medium voltage feeders for connection to the existing electrical distribution system. The A/E shall coordinate with the PO and NIH high voltage supervisor for detailed project specific requirements and for exact medium voltage connection location.

**B. Service Sizing:** Electrical service size shall be adequate to meet the current and future electrical demands. Use [Table 10.2.2\(A\)](#) to estimate approximate electrical demand of a building. Actual building electrical service shall comply with National Fire Protection Association (NFPA) 70 – [National Electrical Code (NEC)] requirements.

**Note:** Exact service requirements will vary depending on the building program. Coordinate exact requirements with facilities operations when a new service is planned for a building.

As the design develops, use actual demand load, not the figures shown on the [Table 10.2.2\(A\)](#), to size the electrical service equipment. Apply appropriate demand factors identified in NFPA 70 when sizing the service.

### 10.2.2.1 Medium Voltage Service Equipment

**A. General:** Each secondary spot network shall include a 15 kV primary switch, network transformer, and a secondary network protector. The substation manufacturer shall provide:

1. **Equipment and Components:** All major secondary spot network equipment, control devices, protective relays, and metering components; minimum two open and two closed auxiliary contacts for all breakers
2. **Remote Monitoring and Control:** Components for remote monitoring and control of all main, tie, and feeder circuit breakers as determined by NIH campus Supervisory Control and Data Acquisition (SCADA)
3. **Warranty:** A single warranty covering all substation assemblies, transformers, and components

4. **Standards:** Substation components designed, assembled, tested, and installed in accordance with the latest applicable standards of National Electrical Manufacturers Association (NEMA), IEEE, and ANSI
5. **Metal Enclosed, Medium Voltage Fusible Load Interrupter Switchgear:** Load Interrupter Switchgear shall be provided in accordance with applicable provisions of ANSI/IEEE C37.20.3

**B. Primary Switch:** The 15 kV primary switch shall be load break type with three-positions: open, closed, and ground. The center position shall be “Closed”. Key-interlock this switch with the transformer tap-changer mechanism such that the switch shall be in the ground position before the transformer taps can be changed.

*Rationale: This is to ensure safety of the personnel involved in the servicing the equipment.*

**C. Network Transformer:** Each of three network transformers, without any forced air cooling, shall be capable of supplying 50% of the total building loads along with 25% future expansion loads. For two network transformers systems – each transformer shall be capable of supplying 100% of the total load, along with 25% future expansion loads, without any forced air cooling.

*Rationale: This is to allow removal of one network transformer from service while the remaining two network transformers carrying the entire connected load and an additional 25% future load indefinitely without any forced cooling of the transformers.*

General requirements for the network transformers are as follows:

1. **Coil Material:** Copper
2. **Insulating Liquid:** NIH approved less flammable natural ester
3. **Cooling:** Class OA/FFA, self-cooled, and with provisions for future forced air cooled rating
4. **Accessories:** Include the following additional accessories:

**Table 10.2.2(A) Normal Power Load Demand**

Area	Administrative	Laboratory	Animal
Load	VA/m <sup>2</sup> (VA/ft <sup>2</sup> )	VA/m <sup>2</sup> (VA/ft <sup>2</sup> )	VA/m <sup>2</sup> (VA/ft <sup>2</sup> )
Lighting	5–16 (0.5–1.5)	5–22 (0.5–2.0)	5–22 (0.5–2.0)
Receptacles & equipment	22–32 (2–3)	65–161 (6–15)	22–43 (2–4)
HVAC <sup>a</sup>	22–43 (2–4)	86–108 (8–10)	86–108 (8–10)
Elevators	11–16 (1– 1.5)	11–16 (1–1.5)	11–16 (1–1.5)
Miscellaneous	5–11 (0.5–1)	5– 11 (0.5–1)	5–11 (0.5–1)
Total range	65–118 (6–11)	172–318 (16–30)	129–200 (12–19)

<sup>a</sup> Heating, ventilating, and air conditioning (HVAC) load assumption is based on a separate central HVAC utility plant supplied by a different service.

- a. Temperature gauges with resettable maximum pointers
  - b. Sampling valves
  - c. High pressure release valves
  - d. Key interlocked tap changer with five settings, one at primary voltage, the other four nominal 2.5% taps – 2 above and 2 below rated primary voltage
  - e. Alarm contacts for SCADA interface
5. **Impedance %Z:** The percent impedance voltage, as measured on the rating voltage connection shall comply with ANSI C57.12.40. Transformers of the same rating to be operated in parallel shall have uniform impedance. New network systems being provided for replacement in existing buildings shall have impedance equal to or greater than existing units to preserve the distribution system’s available fault.
- standard. Meet ANSI/NETA interrupting capacity.
2. **Type:** Fully interlocked, dead-front, draw-out design with externally mounted fuses for easy removal of the unit from enclosure for maintenance and inspection by operating a hand-cranked levering system
  3. **Toggle Cam-Controlled Device:** Include a toggle cam-controlled device that shall not allow closure of the contacts until the springs contain sufficient energy to close and latch the contacts onto available fault current.
  4. **Time Delay Relay:** Include a time delay relay to prevent “pumping,” defined as the cyclical opening and closing of the network protector.
  5. **Relay and Control Panels:** Relay and control panels installed on a draw-out control module below the network protector element
  6. **Disconnect Switch:** Include a disconnect switch on the top of or on the opposite wall from the network protector for the maintenance of the network protector. Disconnecting links are not permitted for safety reasons.
  7. **Intelligent Electronic Device (IED):** Each network protector shall have a discrete network IED for communication with terminals located outside the gear. The IED shall be 3-phase type with relay functions to provide selective closing and tripping of auxiliary contacts mounted on

### 10.2.2.2 Secondary Voltage Service Equipment

**A. Network Protector and Relays:** The network protector shall be a maximum rated device by an NIH approved manufacturer and shall be compatible with existing NIH electrical systems. General requirements for the network protectors are as follows:

1. **Standards:** Comply with Underwriters Laboratories (UL) listed and the IEEE C57.12.44

the relay. General requirements for the IEDs are as follows:

- a. Relay trip contact shall close when positive sequence power flows into the network, when net 3-phase reverse power flows through the network protector and when reverse magnetizing current flows to an associated transformer.
- b. Relay shall include three on-board input ports for external sensors.
- c. Relay shall be insensitive to phase rotation.
- d. Selectable relay operation: Traditional straight-line master close curve or the modified circular closed curve.
- e. Microprocessor relay: Operate under the sequence-base algorithm, which provides a flat, unchanging trip response. The relay shall have the capability to communicate information to a data concentrator over a shielded twisted pair communications cable.
- f. The relay shall be enclosed in a NEMA type 6 chemically treated, waterproof drawn brass shell, and any wiring to the relay (including communication cable) shall not compromise the rating.

**B. Secondary Switchgear:** Secondary switchgear shall comprise main circuit breakers and tie breakers of the same ampacity. A main breaker shall serve a section of the main bus while the tie breaker will connect two sections of the main bus. Both main and tie breakers are normally closed forming a spot network.

***Rationale:** This is to allow sectionalizing of the main bus in case of an electrical fault, restricting electrical outage to the faulted section of the main bus.*

Secondary switchgear shall be freestanding type. General requirements for the switchgear are as follows:

1. **Main Bus:** Main bus shall have copper with plating per manufacturer, 4000 A maximum.
2. **Circuit Breaker:** Draw-out type; electrically operated air power breaker or vacuum breaker.

Circuit breaker shall accommodate the inherently high available short circuit interrupting current in a spot network system arrangement.

3. **Number of Mains:** Provide a main circuit breaker on the secondary of each unit substation transformer.
4. **Bus Stubs:** All bus stubs shall have insulated covers.
5. **Cubicles:** All cubicles shall be complete with bus work, rails, wiring, equipment shorting blocks, and circuit breakers.
6. **Spare:** Provide spare cubicles with circuit breakers. Provide a minimum of one spare circuit breaker mounted in a spare cubicle per frame size utilized in the switchgear lineup.
7. **Spaces:** All spaces shall be fully bussed (including draw-out assemblies, bussed connections, and hardware) based on frame sizes indicated on design drawings.
8. **Bus Extension:** The switchgear shall be positioned to allow for the addition of a minimum of one vertical section to the switchgear provided that switchgear capacity is not exceeded.
9. **Transient Voltage Surge Suppression:** If Transient Voltage Surge Suppression (TVSS) is required for a switchgear, TVSS shall be a modular type and shall be installed within the switchgear. TVSS may be protected by a molded case circuit breaker with appropriate short-circuit interrupting rating (which is normally not allowed to be installed in switchgear).
10. **Grounding:** Ground each transformer neutral only once inside the service entrance equipment in the building to provide single point grounding.
11. **Spot Network Grounding:** Use ground return sensing on main and ties, and residual sensing on feeders for proper selective ground fault operation and isolation of a fault in a spot network system. [Figure 10.2.1\(A\)](#) and [Figure 10.2.1\(B\)](#) demonstrate the ground fault relaying scheme for single point grounding, network type switchgear. Transformer neutral points

are brought into the switchgear and grounded at a single point only. The transformer neutral points are not bonded to ground at the transformer. The use of multiple point grounding or modifications to differential ground fault protection shall not be used.

**12. Overcurrent Device:** Overcurrent devices shall have:

- a. Short-time, long-time, ground fault, and instantaneous trip settings
- b. Overvoltage, undervoltage, and phase sequence protection for all incoming lines
- c. Ground fault protection for all circuit breakers serving 480/277 V, 3-phase, 4-wire bus risers, switchboards, and distribution panels that can possibly serve fluorescent and exterior lighting
- d. Electrically operated mechanism to allow remote operation by the campus SCADA system
- e. Discrete contacts for open/close status of the main and tie breakers wired to the terminal strips for convenient SCADA system connection.

**13. Metering:** Each main breaker shall have a digital power meter connected on the load side of the breaker to measure total output power of the switchgear. The main circuit breaker power meter shall meter the following items:

- a. Volts (phase-to-phase and phase-to-neutral)
- b. Frequency
- c. Ampere demand (per phase and average 3-phase)
- d. Kilowatt hours (with reset)
- e. Kilowatt demand (3-phase)
- f. Kilowatt peak demand
- g. kVA (3-phase)

- h. Harmonic load content (percent total harmonic distortion [THD])
- i. Power factor

Each feeder breaker shall have self-contained local digital metering with remote reporting capability and be wired to a common communication interface. The feeder breaker power meter shall meter the following items:

- a. Volts (phase-to-phase and phase-to-neutral)
- b. Amperes
- c. Kilowatt hours (with reset)
- d. Kilowatt demand
- e. Kilowatt peak demand

**14. Control Power:** The control power for low voltage circuit breakers shall be 120 V AC. The switchgear shall include the provision for a control power transformer with each switchgear section and the necessary switching logic so that there shall be 120 V relay and control power if any one of the three network transformers is energized. All potential transformer (PT) and current transformer (CT) connections shall be wired to shorting blocks.

**15. Test Switches:** Test switches for all IEDs for maintenance, repair and replacement of IEDs when necessary.

**16. Lifting:** Provide a hoist for lifting the circuit breakers from their withdrawn position and lowering them to a dolly or to the floor. Provide a rail assembly along the top of the switchgear with a hoist mechanism that can roll from one end to the other.

**17. Heaters:** Provide electrical strip heaters in switchgear to prevent internal condensation.

**18. Tools:** Turnover all specialized tools necessary for installation, maintenance, calibration, and other testing tools supplied with the equipment to the NIH at the end of the construction project.

**C. Distribution Transformer:** Distribution transformers shall have delta connected primary and solidly grounded wye connected secondary. The transformer shall have self-cooled capacity for 100% of the connected load, plus 25% spare capacity for future loads.

*Rationale: This is to meet future growth in electrical demand.*

General requirements for the distribution transformers are as follows:

1. **Coil Material:** Copper for liquid filled transformers; copper or aluminum for dry-type transformers
2. **Insulating liquid for liquid filled transformers:** NIH approved less flammable natural ester
3. **Accessories:** Include the following additional accessories:
  - a. Liquid level, pressure/vacuum, and temperature gauges with alarm contacts for liquid-filled transformers
  - b. Tap changer with five settings, one at primary voltage. The other four nominal 2.5% taps – two above and two below rated primary voltage
  - c. Alarm contacts for SCADA interface
4. **Dry-type Transformer:** Use K-rated dry-type transformers in accordance with [Section 10.6.1 Harmonics](#). When the average daily load of the transformer is less than 50% of the nameplate rating, use an ENERGY STAR labeled transformer that complies with NEMA TP. Otherwise, use low-temperature-rise transformer with rated temperature rise of 80°C (176°F) or less.

**D. Switchboard and Panelboard:** General requirements for switchboard and panelboard are as follows:

1. **Bus Material:** Copper
2. **Interrupting Capacity:** Circuit breakers shall be fully rated for available fault current; series rating is not acceptable. Circuit breakers shall have published ampere interrupting rating at

125/250 V DC. For purposes of this requirement, it shall be assumed that a DC rating for one-pole and two-pole breakers extends to the three-pole device as well.

3. **Main Circuit Breaker:** Provide a main circuit breaker in the same enclosure if a local disconnecting means is not in the same closet or room.
4. **Type:** All circuit breakers shall be bolt-on type; plug-in breakers shall not be used.
5. **Spare Breaker:** Spare breakers shall be left in the “Off” position.
6. **Directory:** Provide typed directory referencing the actual loads and room numbers for the circuits; mark spare breaker as “Spare” and bussed spaces as “Space” in the directory. The directory shall list the switchboard or panelboard name, the name of the source panel, and the NIH facility number (FAC #). The contractor is liable for the accuracy of the directory regardless of the room numbers used on the contract documents.
7. **Phase Balance:** Arrange single-phase loads between all phases of panelboards to obtain phase balanced to within 15% of the average of the phase current.

Specific requirements for switchboard and panelboard are as follows:

1. **Heat Shrink Insulation Sleeves:** Switchboards 800 A and above shall be provided with manufacturer installed heat shrink insulation sleeves.
2. **Minimum Interrupting Capacity:** The minimum short circuit rating for 208 Y/120 V panelboards must be 10,000 A symmetrical and for 480 Y/277 V panelboards must be 14,000 A symmetrical.
3. **Branch Circuit Panelboards:** Branch circuit panelboards shall be 3-phase, 4-wire; have minimum 42 poles for panelboards with ampacities greater than 100 A.
4. **Ganged Single Pole Circuit Breakers:** Single pole breakers shall not be ganged to form multiple breakers.



- 5. **Neutral Bus:** In general, provide a 100% neutral bus and a ground bus. Panelboards serving high harmonic loads (more than 50% non-linear load) shall have 200% rated neutral bus. Refer to [Section 10.6 Power Quality and Grounding](#).
- 6. **Bussing:** All panelboard breaker bussing (extension fingers), including spaces, shall be rated for minimum 100 A for panelboard rated 225 A and higher; and a minimum 60 A for panelboards rated 200 A or less.
- 7. **Trim:** Provide one full height piano hinged trim for all single section panelboards 400 A and higher; two, one for each side, for dual-section panelboards. The trim shall hinge open with the removal of a few screws.
- 8. **Lock:** The panel door giving access to the circuit breakers only shall have a flush tumbler lock.
- 9. **Key:** All panelboard doors within a building shall be keyed alike. New panelboards installed within an existing building shall be keyed to match the existing panelboards.
- 10. **Spare Pole Positions:** For all 120/208V panelboards and 277/480V lighting panelboards (primarily used for lighting circuits), provide single pole, 20A branch circuit breakers in all unused spare pole positions.
- 11. **Isolated Ground Bus:** Panelboards serving isolated ground (IG) receptacles shall have an IG bus in addition to the equipment ground bus. Clearly label the IG bus and size the IG conductors to match the phase conductors. Connect the IG conductor to the panelboard's IG bus. Refer to [Section 10.6 Power Quality and Grounding](#), for grounding requirement.

- 12. **Operating Rooms in ABSL Facilities:** Provide isolated power panels with ungrounded secondary and line isolation monitors for operating rooms in ABSL facilities.

**E. Distribution Panels:** Distribution panels shall be defined as those panels serving branch circuit panelboards and other 3-phase loads. Distribution panels shall be labeled “DP-1, 2, 3,” etc. Refer to [Table 10.2.2\(B\)](#) for criteria in sizing distribution panels for future space allocation.

**F. Busway:** Install busways such that there is an adequate code required clearance for the current and future plug-in devices. Contractor shall be liable for field measurement of the busway layout prior to ordering. General busway requirements are as follows:

- 1. **Feeder Busway Maximum Current Rating:** 2,000 A
- 2. **Bus Material:** Current-carrying copper bus, fully insulated with Class 130°C (266°F) insulation except at joints. Provide plated surface at joints. Aluminum busway shall not be used.
- 3. **Type:** Use non-ventilated busway in dry locations. For wet or moist locations, use the busway listed for use in the application environment. Busway shall be “drip-proof” for horizontal and vertical applications where busway run beneath piping, or vessels containing liquids, or ductwork.
- 4. **Concrete Curbs:** Provide 102 mm (4 in.) concrete curbs at all vertical busway penetrations

**Table 10.2.2(B) Distribution Panel Sizing**

Maximum Active Poles	Minimum Spare Poles	Total Poles
14	4	18
23	7	30
32	10	42
45	15	60
66	As required	66+ required spaces

### 10.2.3 Motor Control

**A. Starter Type:** Provide motor starter as scheduled below:

- 1. **Thermal Manual Starter:** Motors rated 370 W (½ hp) or smaller. Thermal manual motor starters shall be a non-automatic resetting type, lockable in the Off position, and have overload elements sized per full load current of motor being protected.

2. **Magnetic Starter:** Motors smaller than 22.4 kW (30 hp)
3. **Reduced voltage/soft start controller:** Motors rated 22.4 kW (30 hp) or higher
4. **Variable Frequency Drive:** Variable Frequency Drive (VFD) when required by the mechanical systems shall adhere to the requirements listed under [Section 6.2.8 Motor and Variable Frequency Drives](#). VFD with bypass shall have reduced voltage or soft start motor controller for motors rated 22.4 kW (30 hp) or higher.

**B. Starter Requirements:** Provide NEMA rated starters. Starters shall have:

1. Either a fused disconnect or a motor circuit protector
2. Integral single-phase protection against loss of any phase voltage for 3-phase motors
3. Red light-emitting diode (LED) running pilot light; green LED power-available pilot light
4. Hand-off-automatic (HOA) switch
5. Control power transformer (CPT) with two primary fuses and one secondary fuse, with secondary voltage of 120 V. Provide disconnecting means for both line and control circuits.
6. Two normally open (NO) and two normally closed (NC) auxiliary contacts with provision for four additional auxiliary contacts
7. Mechanical override to open the starter enclosure while energized

**C. Motor Control Center (MCC):** Provide MCC when four or more three phase motors rated larger than 370 W (½ hp) are located in the same area. MCC shall comply with the following:

1. **Bus Material:** Copper
2. **Starter:** Plug-in starters with no hard wiring directly to the starter. Minimum starter size in motor control center shall be size 1.
3. **Short Circuit Protection:** Starters shall conform to IEC 947-4-1 type 2 component protection in the event of a short circuit.

4. **Control Wiring:** All control wiring (in or out) shall be extended to terminal strips in a central location in the MCC in accordance with NEMA Standard ICS 2-322, Type C wiring.
5. **Metering:** Provide advanced metering for remote monitoring.
6. **VFD:** VFDs shall not be installed in MCCs.
7. **Heaters:** Provide a strip heater inside the enclosure when MCC is installed outdoors.

**D. Other Requirements:**

1. **High Efficiency Motors:** Provide overcurrent protection sized per manufacturer's recommendations in compliance with NEC for high efficiency motors.
2. **Control Operation:** Provide ladder diagrams and sequences of operations for all control functions. This applies to heating, ventilating, and air conditioning (HVAC) systems, automatic temperature controls (pneumatic or electric), plumbing, fire protection, security, programmable lighting control, etc.
3. **Enclosure:** Comply with environmental condition at the installed location.
  - a. **Dry and indoor locations:** NEMA type 1
  - b. **Indoor locations subject to excessive dust or dirt:** NEMA type 12
  - c. **Outdoor locations:** NEMA type 4
  - d. **Wash down or corrosive locations:** NEMA type 4X

Equivalent ingress protection (IP) rated enclosures are also acceptable.

---

## 10.2.4 Electrical Work Space

Coordinate with architect and other disciplines to comply with the following requirements.

**A. Location:** Transformers, secondary substations, distribution switchgears, generators, transfer switches and other electrical distribution equipment shall not

be located at the lowest points of the buildings below grade level. In addition, comply with the following requirements:

1. **Medium Voltage Transformer:** The optimal location for the medium voltage primary service transformers is indoors in a transformer vault, located separately from the service entrance switchgear room, and not in the same room as the emergency power distribution gear. The secondary service bussing shall be kept as short as possible and electrically the same length ( $\pm 10\%$ ).
2. **Low Voltage Distribution Equipment:** Locate all branch circuit panelboards and distribution panels at the center of the area being served, secured from the general public. Electrical loads shall be served from the panelboards located on the same floor and located closest to the load.

*Exceptions: Lighting and power circuits within vertical stairways, elevator shafts, roofs, and interstitial areas.*

**B. Clearances:** Provide the minimum required clearances per code for all equipment. Provide 76 mm (3 in.) minimum separation between panelboards. Lay out the electrical equipment in electrical rooms and closets such that there is an unobstructed exit path out of the room. The following minimum clearances are required for new projects around secondary switchgear:

1. 1,524 mm (5 ft.) in front
2. 1,067 mm (3 ft. 6 in.) in rear
3. 914 mm (3 ft.) on the ends

Consider additional clearance for the equipment being racked out.

**C. Electrical Room and Transformer Vault:** Install all substations, switchgears, switchboards, transformers, and network protectors in dedicated electrical rooms or vaults. Equipment installation shall meet the following requirements:

1. **Room Size:** Size electrical rooms to accommodate current electrical equipment and required clearances. Consideration should be given to additional room for future anticipated growth.

2. **Clearance:** Provide clear working space around the equipment in accordance with electrical code and this manual. Columns shall not encroach on the clear working space required around equipment.
3. **Other Equipment:** Piping, ducts, or equipment not serving the dedicated electrical rooms shall not be permitted to be installed in the electrical rooms or traverse the electrical rooms.
4. **Ventilation (and/or cooling):** Rooms with transformers shall have ventilation (and/or cooling) sufficient for 2% of the total transformer kVA expressed in watts of heat load. Coordinate cooling requirement with HVAC system design. Refer to [Chapter 6: Mechanical Design](#).

**D. Electrical Closets:** Electrical closets shall be provided for every 929 m<sup>2</sup> (10,000 ft<sup>2</sup>) of area served by 208/120 V branch circuit panelboards; for every 1,858 m<sup>2</sup> (20,000 ft<sup>2</sup>) of area served by 480/277 V lighting panelboards. Locate panelboards so that the farthest 120 V device/equipment served is no more than 30 m (100 ft.) away. General requirements for electrical closets are as follows:

1. **Stacking:** Vertically stack electrical closets in multistory buildings.
2. **Sleeves:** Provide sealed, water-tight sleeves, extending at least 76 mm (3 in.) above the floor, through the holes in floors of electrical closets.
3. **Location:** Closets shall be located away from the mechanical shafts; coordinate location with all other building systems, particularly those located in the ceiling plenum directly adjacent to the closet.

*Exception 1: Shallow closets with full doors on the long wall are acceptable in lieu of electrical closets for smaller renovations.*

*Exception 2: Secure service corridor may be used for the installation of panelboards.*

**E. Equipment Removal Route:** A permanent exit route shall be provided for the large electrical equipment including transformer, generator, switchgear, etc., to remove the large equipment and bring in new replacement units. A faulty transformer shall be capable of

being removed while the other transformer(s) and equipment remain in place and in operation. Provide painted stripes and warning signs on the floor and walls along the exit (removal) route. See [5.1.7 Equipment Access](#).

---

## 10.2.5 Other Requirements

**A. Equipment Pad:** Concrete equipment pad (102 mm [4 in.]) or manufacturer specification, whichever is higher) for all floor mounted electrical equipment shall be provided. Refer to [Chapter 5](#).

**B. Outdoor Installation:** All cables on outdoor installations shall be provided in weatherproof metallic wireways to protect cables from ultraviolet radiation degradation.

**C. Arc Flash Warning:** Transpose the data from the arc flash study on NFPA 70E approved labels for all panelboards, motor control centers, switchgears, and major electrical distribution equipment. Identify protection boundary per Occupational Safety and Health Administration (OSHA) 1910 and NFPA 70E.

# Section 10.3

## Emergency Power

---

### Contents

10.3.0 Introduction

10.3.1 Emergency Electrical Systems

10.3.2 Emergency Power Generation

10.3.3 Emergency Power Distribution

10.3.4 Other Requirements

## 10.3.0 Introduction

When required, emergency electrical power distribution at the Bethesda campus typically employs diesel generators to support life safety, legally required and optional standby loads.

### 10.3.1 Emergency Electrical Systems

**A. Emergency System Sizing:** Emergency electrical service size shall be adequate to meet the current and future emergency electrical demand, and applicable codes and standards. Use [Table 10.3.1](#) for preliminary equipment sizing of emergency electrical systems. Coordinate exact requirements with facilities operations when a new emergency electrical service is planned for a building.

***Rationale:** This is to ensure that emergency electrical service will meet current and future demand of the facility.*

As the design develops, use actual demand load—not the figures shown in [Table 10.3.1](#) to size the electrical service equipment. Size the generator to serve approximately 125% of the actual current demand load to allow for future load growth. Actual building emergency electrical service size shall be in accordance with NFPA 70 and National Electrical Code (NEC) requirements.

**B. Life Safety Loads:** Life safety loads shall include the following (this list is not all-inclusive):

1. Emergency egress lighting
2. Egress signage
3. Communications systems (including public announcement [PA] systems)
4. Fire alarm and mass notification systems
5. Self-contained, battery-powered lighting at generator set location
6. Fire-suppression systems (fire pumps, jockey pumps, compressors, valves, etc.)
7. Automatic doors used for egress

**Table 10.3.1 Emergency Power Load Demand**

Area	Administrative	Laboratory/ Animal Research
Load	W/m <sup>2</sup> (W/ft <sup>2</sup> )	W/m <sup>2</sup> (W/ft <sup>2</sup> )
Lighting	1–5 (0.1–0.5)	1–5 (0.1–0.5)
Receptacles	1–2 (0.1–0.2)	1–2 (0.1–0.2)
Heating, ventilating, & air conditioning	1–32 (0.1–3.0)	1–32 (0.1–3.0)
Laboratory equipment		16–43 (1.5–4.0)
Elevators	1 (0.1)	1 (0.1)
<b>Total range</b>	<b>4–40 (0.4–4)</b>	<b>20–83 (2–8)</b>

8. Elevator cab lighting, control, communication, and signal systems
9. Generator day tank pump
10. Stairwell pressurization systems
11. Medical gas alarm systems
12. Electrically actuated fire dampers

**C. Legally Required Standby Loads:** Legally required standby loads shall include the following (this list is not all-inclusive):

1. Fire department receptacles
2. Pumps, components and all devices associated with fuel stored in large storage tanks serving the emergency generator except oil circulation pumps, which shall be connected to normal power
3. Generator battery charger
4. Sewage and storm drain ejector systems
5. Sump pumps
6. Sump dewatering pumps
7. Critical supply and exhaust fans
8. Building Automation Systems (BAS) including control air compressor



9. One elevator per bank of elevators. All elevators shall be on emergency power with only one elevator per each bank of elevators to run at a given time. The lock-out of the elevators shall be provided by the elevator controller.
  10. Air handling system serving the elevator machine room when elevators are on emergency power
  11. Air handling systems associated with active smoke purge/evacuation systems
  12. Strip heater for transfer switch
  13. Security, intrusion detection, and access control systems
  14. Heat tapes for sprinkler pipes
  15. Fume hood exhaust fans
  16. All supply and exhaust fans including laboratory exhaust, animal research facility (ARF) exhaust, and other critical exhaust air fans for BSL-3/ABSL-3 areas
  17. ARF medical gas systems
  18. ARF operating room lighting and receptacles
  19. Fire control room power, lighting
- D. Optional Standby Loads:** Optional standby loads shall include the following (this list is not all-inclusive):
1. UPS systems
  2. Automatic temperature control system components
  3. Auxiliary mechanical equipment that supports heating and cooling systems
  4. Closed circuit television cameras and associated equipment
  5. Lighting control systems
  6. Select lighting in electrical distribution equipment, mechanical and main telecommunication rooms
  7. Computer room air handling units (AHUs)
  8. Air conditioning units serving main telecommunication room
  9. Heating systems including boilers, heating water pumps, and associated fuel oil system
  10. Steam condensate pumps
  11. Domestic and industrial/laboratory water pumps
  12. Hands-free toilet flushers and lavatory faucets
  13. Electrical heat tracing for hydronic piping
  14. Minimum one receptacle at each electrical room/closet and mechanical room
  15. Environmental rooms
  16. Biological safety cabinets, incubators, bio-bubbles, containment devices, etc.
  17. Supply and exhaust air fans for laboratory and animal research facilities for BSL-2/ABSL-2 areas
  18. Laboratory equipment alarm-monitoring system
  19. High-value specimen refrigerators, freezers, etc.
  20. Lighting and lighting control systems in animal research facilities, if defined by program requirements
  21. Water chillers, cooling towers, pumps and associated systems, which serve critical areas
  22. Critical scientific equipment identified by program requirements
  23. Supply fans associated with exhaust fans connected to emergency power
  24. Laboratory air compressors and dryers
  25. Laboratory vacuum pumps
  26. Laboratory gas cylinders/Dewar manifolds
  27. Animal water system
  28. Animal caging with power ventilated rack systems, if defined by program requirements
  29. Select outlets along corridors in ARFs
  30. Fire control room HVAC

## 10.3.2 Emergency Power Generation

**A. Equipment Location:** Install generators, transfer equipment, paralleling equipment, and emergency switchgear above grade and in a secured area. General installation requirements are as follows:

1. **Standards:** Emergency power generation equipment installation and startup procedures shall follow NFPA 110.
2. **Location:** Locate power generation equipment where engine, fan, exhaust, and permanent load bank testing noise levels shall be acceptable. Locate emergency power supply equipment close to the main power consuming equipment and locate supply equipment away from high ambient temperatures.
3. **Clearance:** Provide at least 1.2 m (4 ft.) of clearance around the generator set. Ensure all generator enclosure access panels and doors can be fully opened.
4. **Accessible:** Easily accessible for service and future replacement. There shall be access for replacement of the generator without moving other equipment or accessories, such as a day tank.
5. **Vibration:** Include provisions for avoiding structure-borne vibration.
6. **Protection:** Protect electrical equipment from weather and vandalism.
7. **Equipment Pad:** A concrete equipment pad shall be provided for all floor mounted equipment. Refer to [Section 10.2.5](#).
8. **Generator Exhaust:** Refer to [Section 6.2: Supply Air Handling Systems](#).

**B. Outdoor Installations:** The optimal generator location is outdoors in a sound-attenuated enclosure with an adequate working space around the generator. Outdoor installations shall comply with the following requirements:

1. **Noise Level:** The sound-attenuated enclosure shall provide 70 to 79 dB maximum noise

level at 6.1 m (20 ft.) from the enclosure at rated output, regardless of the generator size. The generator noise levels at the property line shall follow the local county noise ordinances and requirements. Assess noise performance requirements early in the design cycle and design appropriate sound attenuation measures based on the site conditions.

2. **Silencer or Muffler:** Provide generator exhaust silencer or muffler rated for minimum residential use or quieter to achieve the required sound rating.
3. **Remote Tank:** Provide power and monitoring wiring for the remote tank level gauge.
4. **Jacket Water Heater:** Provide jacket water heater connected to normal power for reliable starting in cold weather. Provide isolation valves to allow for jacket water heater replacement.
5. **Physical Security:** Coordinate with Division of Physical Security Management (DPSM) representative for additional physical security requirements.

**C. Indoor Installations:** If site constraints are such that the generator shall be located indoors, indoor installation shall comply with the following requirements:

1. **Sound Attenuation:** Sound attenuate the generator room to achieve noise level acceptable to the surrounding occupants.
2. **Ventilation and Air Conditioning:** Refer to [Section 6.2: Supply Air Handling Systems](#).
3. **Equipment Removal Path:** Identify the exit route for the removal of the generator on the drawings. Refer to [Section 10.2.4 Electrical Work Space](#).

**D. Fuel Oil Systems:** Refer to [Section 6.2: Supply Air Handling Systems](#).

**E. Load Bank:** Provide permanently installed fully rated resistive load banks for all generators 1,500 kW and higher. Provide a portable load bank connection point for smaller generators. This connection point shall be suitable for a portable generator with interlocking means provided to prevent concurrent operation of

normal and emergency power. Load bank installation shall comply with the following requirements:

1. **Connection Requirements:** Provide all necessary wiring for load bank testing with proper external building terminal connections and shunt trip circuit breaker for connection to the load bank. Provide a number of lugs based on parallel #500 KCMIL cable connections to a portable load bank.
2. **Load Dump:** Wire the load dump control circuit in the load bank to the shunt trip circuit breaker control. If the building calls for emergency power while the generator is being exercised by the load bank, the load bank circuit breaker shall immediately open, dropping the load bank from the generator bus.

*Rationale: This is to allow transfer to emergency power in case of true emergency while load bank testing is still in process.*

3. **Grounding:** Provide an accessible driven ground rod tied to the electrical grounding system at the portable load bank connection location.

### 10.3.3 Emergency Power Distribution

The emergency distribution panel and all emergency gear up to the load end of the automatic transfer switches (ATSs) shall be located in a separate dedicated electrical room away from the normal power electrical room.

*Rationale: This is to minimize simultaneous disruption of both normal and emergency power sources.*

**A. Transfer Switch:** General requirements of transfer switch are as follows:

1. **Switch Type:** All life safety and legally required power distribution systems shall utilize automatic transfer switches. Manual transfer

switches are acceptable for environmental room retrofits.

2. **Poles:** For all new construction and complete renovation, utilize 4-pole transfer switches for 3-phase, 4-wire systems.

*Rationale: This is to provide complete isolation among power sources.*

For existing emergency power system renovation or upgrade, the number of switched poles (3 or 4) in a transfer switch shall match the existing number of switched poles.

3. **Grounding and Bonding:** Ground the generator neutral for 4-pole switches in accordance with NEC requirements. For 3-pole switches, the lifting of the generator's neutral to ground bond shall comply with NEC requirements for 3-pole, solid neutral power transfer.
4. **ATS:** ATS shall have the following function and characteristics:
  - a. UL listed in accordance with UL 1008
  - b. Fully automatic, open transition, "break before make" operation
  - c. Electrically operated and mechanically held. ATS shall not have two circuit breakers with the trip handles physically connected.
  - d. ATSs without center off time delay shall have an in-phase monitor. ATS shall have center off-time delay when serving motors.
  - e. ATS is only allowed to initiate transfer to the other source when the other source is a "good source," defined as one with line voltage within  $\pm 10\%$  nominal rating and with frequency of  $60 \text{ Hz} \pm 0.5\%$ .
  - f. Allow for a safe transfer of power source via an external manual operator (EMO) to mechanically operate the ATS under load. Pushbuttons shall not be used as EMOs. The EMO shall allow transfer of the switch to any position regardless of the condition of the source.

- g. Provide rack-out mechanism for removal of ATS while load is still connected.
  - h. Microprocessor controlled meters installed on the load side of the transfer switch to monitor the load whether the source is normal or emergency. At a minimum, metering shall consist of a voltmeter that measures all three phases simultaneously, an ammeter, a frequency meter, a kW meter, a power factor (PF) meter, and an analog bar graph for easy reading of voltage and current.
  - i. ATS shall be located indoors. If a waiver is granted for an outdoor location, ATS shall have door-in-door NEMA type 4X construction. Provide a strip heater inside the enclosure when ATS is installed outdoors.
5. **Bypass:** Use only bypass type transfer switch. The bypass switch shall be capable of being manually connected to either source under load regardless of the condition of the source or transfer switch position.

***Rationale:** This is to allow removal of ATS for servicing with only a momentary loss of electrical power.*

**Note:** The size of a transfer switch increases with the addition of the bypass feature.

- 6. **Manual Operator:** The manual operator shall be readily and permanently accessible without opening the enclosure door.
- 7. **Clearance:** Ensure additional working clearance is provided for component in a racked-out position.

**B. Emergency Distribution Panel:** Where two or more ATSs are installed, provide an emergency distribution panel (EDP) for future addition of ATSs.

***Rationale:** This is to provide minimal interruption to the emergency power system.*

**C. Bypass Breaker:** A bypass circuit breaker may be provided for shunting of excess generating capacity.

When a bypass breaker is provided for this purpose, the bypass breaker shall be key interlocked to prevent any possibility of normal power being connected in parallel with the local generator when normal power is restored.

***Rationale:** This is to allow shunting of surplus generating capacity of the on-site generators to non-emergency loads in case of extended outage.*

**D. Portable Generator:** Provide a portable generator receptacle for all installations where a generator is not required or provided. Currently, the largest NIH portable generator size is 1000 kW.

When an on-site generator is deemed necessary, receptacles for the connection of a small NIH-owned portable generator may also be required on a project-by-project basis. Portable generator connection requirements are as follows:

1. **Receptacles:** Portable generator connection shall include the following devices, which shall be compatible with the existing NIH campus components and systems:
  - a. 200 A, 480/277 V, 4-pole, 5-wire junction box, angle adapter, and pin and sleeve receptacle, with either integral or separate series rated over the current protective device where receptacles are parallel. The quantity of parallel 200 A receptacles shall match the loads connected to the portable generator, not to exceed maximum portable generator output.
  - b. One 15 A, 125 V, 2-pole, 3-wire NEMA type 5-15R with a flip-lid cover for 120 V AC load bank control or battery charger
  - c. One 15 A, 125 V, 2-pole, 2-wire-locking NEMA type L1-15R with a flip-lid cover for remote start circuit
  - d. One 20 A, 250 V, 2-pole, 3-wire-grounding NEMA type 6-20R with a flip-lid cover for 208V AC heater circuit
2. **Receptacle Installation:** Install receptacles for load bank control or battery charger, remote start, and heater in a NIH approved box, directly adjacent to the boxes containing other 200 A power

receptacles; wiring for these receptacles may be combined with the larger power conductors.

3. **Receptacle Location:** Locate all generator receptacles 914 mm (3 ft.) above finished grade at or near an accessible roadway, parking lot, or loading dock.

---

## 10.3.4 Other Requirements

**A. Emergency Power Wiring:** Wiring for the emergency power shall be separate from the normal power; utilize separate raceways for these two systems. Do not use raceway with dividers to route both emergency and normal power circuits.

**B. Local Fire Department:** Emergency power installation shall comply with local fire department requirements. Facilities located within Montgomery County shall comply with the following requirements:

1. Provide a single 20 A 3-wire twist-lock receptacle (NEMA type L5-20R) at each level as high as the hose connection outlet adjacent to each standpipe.
2. Provide a similar receptacle in the corridor adjacent to the stairwell. In long corridors, provide additional similar outlets, with maximum 30 m (100 ft.) spacing between them. Provide

receptacle covers. Covers shall be fire alarm red in color and be marked “ONLY FOR FIRE DEPARTMENT USE.”

3. Provide a 20 A, 120 V emergency circuit per floor and a 30 A 120 V emergency circuit for each standpipe riser to the above listed stairwell twist-lock receptacles.

*Note:* 20 A receptacles on a 30 A circuit is not NEC compliant, but accepted by the local jurisdiction for this specialty usage.

4. For exposed installation, the wiring shall be in rigid galvanized steel (RGS) conduit and receptacle boxes shall be metal, weatherproof type, with gasketed flap-door covers and threaded hubs. For concealed work, wiring shall be in electrical metallic tubing (EMT) conduit with appropriate galvanized boxes having gasketed flap-door covers suitable for Fire Department use.

**C. NIH Fire Department:** Provide a duplex receptacle connected to the emergency power system in the corridor within 6 m (20 ft.) of each stairwell entrance for the use of the NIH Fire Department in case of emergency events and shall be so marked with appropriate signage so that the receptacle shall not be blocked or hidden by equipment.

**D. Security:** For specific security requirements, contact PO to coordinate with DPSM. See [Section 1.13](#) for additional information.

# Section 10.4

## Site Electrical Distribution

---

### Contents

10.4.0 Introduction

10.4.1 Distribution Duct Systems

10.4.2 Manhole and Handhole Installation



## 10.4.0 Introduction

The NIH Bethesda campus medium voltage (13.8 kV) electrical distribution systems, emergency electrical systems and communication system utilize underground distribution duct systems (DDS). The DDS comprise concrete-encased polyvinyl chloride (PVC) ducts installed between manholes. This section covers site electrical distribution on the NIH Bethesda campus. Refer to [Section 11.4](#) for site utility requirements of telecommunication systems on the NIH Bethesda campus.

### 10.4.1 Distribution Duct Systems

**A. General Requirements:** DDS installation requirements are as follows:

1. **General:** Provide separate ductbanks and manholes for normal power, emergency power and communication systems. Spacing between ductbanks shall be at least 305 mm (1 ft.). Provide separate manholes for low and medium voltage systems.

*Rationale: This is to provide greater reliability of service.*

2. **Redundancy:** When redundant service is required for power and communication, ductbank routes shall traverse diverse paths.
3. **Coordination:** Ductbank routes shall avoid the foundations of other buildings and structures. In addition, ductbank routes shall be kept away from other underground utilities such as steam, hot water, chilled water, and gas. Coordinate ductbank routing and locations of manholes early in the design with the PO.
4. **Ductbank Type:** Distribution ductbank system shall be minimum 4-way; have 78 mm (3 in.) duct spacing in all directions.

*Rationale: This is to round out and/or provide additional spare duct(s).*

5. **Spare Capacity:** When new ductbank runs and manholes are installed, provide additional ducts for future expansion (minimum 25% spare ducts). In addition to the required number of ducts, provide at least two or more spare ducts as required to have a symmetrical configuration. Odd numbers of duct, such as 7, 11, or 13, shall not be constructed.
6. **Duct Size:** Minimum inside diameter of a duct for medium voltage distribution shall be 129 mm (5 in.).
7. **Bending Radius:** Changes in direction of ducts shall have bending radius of 1.2 m (4 ft.) or larger.
8. **Cable Pulling:** Consider the pulling tension of the cable. The maximum cable length between manholes shall be less than 122 m (400 ft.) for an essentially straight run and reduced by 15.2 m (50 ft.) for each bend of 45°; and by 30 m (100 ft.) for each bend of 90°. Bending radius of the cable shall be as large as possible. Total amount of bends between manholes shall not exceed 270°. Cable pulling tension calculations are required to document each cable length. Cable lengths shall be optimized to minimize (or eliminate) splices. Splices, when required, shall be located in the manholes.
9. **Sealing:** Seal all empty ducts to prevent water seepage into the handhole or manhole.
10. **Ground Conductor:** Include a #4/0 bare copper ground conductor in 27 mm (1 in.) duct within each ductbank section.
11. **Duct Type:** Utilize schedule 40 PVC or encased burial (type EB) ducts for all underground electrical and communication systems as scheduled in [Section 10.5 Wiring Methods and Other Requirements](#).
12. **Direct Buried:** Direct buried schedule 80 PVC and PVC coated RGS conduit may be used for exterior low voltage (600 V or below) branch circuit conduits 41 mm (1-1/2 in.) or smaller.

**B. Concrete Encasement:** Encase all medium voltage feeder conduits in concrete. Concrete encasement shall have steel reinforcement in a plane just below the lowest

row of ducts when ductbank spans disturb earth, when ductbank enters manholes and buildings (out to 1.8 m [6 ft.]), and when ductbank crosses under roadways. Do not tie ductbank reinforcing steel with precast concrete reinforcement steel.

***Rationale:** This is to ensure that electrical duct distribution system is protected from accidental earth work.*

**C. Elevation Considerations:** Locate the ducts at a minimum 762 mm (2 ft. 6 in.) clear below grade or below the top of roadway and completely below the frost line. Slope the ducts from the higher manhole entrance to the lower manhole entrance with no intermediate low spots that pool moisture. Slope the ducts entering a building toward the manhole.

If the manhole entrance points are almost at the same level, provide an arch in the duct run to allow drainage from a high point into both manholes. If a low point is absolutely unavoidable, provide another manhole at or near the low point.

***Rationale:** This is to provide positive drainage away from the building.*

## 10.4.2 Manhole and Handhole Installation

**A. General Requirements:** Manhole and handhole installation shall comply with the following requirements:

1. **Handhole Usage:** Do not use handholes for medium voltage power systems. Handholes may be used for low voltage feeders, branch circuits, signal circuits, and communication circuits.

***Rationale:** Use of hand hole is not suitable for a medium voltage system since such systems require large working area.*

2. **Size:** The minimum inside dimensions of manholes shall be 3.7 m x 2.7 m x 2 m (12 ft. x 9

ft. x 6 ft. 6 in.); minimum handhole dimensions shall be 610 mm x 610 mm x 610 mm (2 ft. x 2 ft. x 2 ft.).

3. **Cover:** Provide grounded steel covers for all manholes and handholes. The standard manhole frame and cover shall be 686 mm (2 ft. 3 in.) in diameter (610 mm [2 ft.] inside diameter). The cover shall have a small, flat area for labeling, with the manhole number applied by a welded bead. Provide an embossed brass tag with the manhole number, legible from outside the manhole with the cover removed, inside the manhole collar. Label each manhole cover as “ELECTRIC” for power and “COMMUNICATION” for communication. Each manhole shall have two covers, 13 mm (1/2 in.) above finish grade. One cover is for forced air and materials entry, and the other is for worker access.
4. **Location:** Preference for manhole location is as follows: grass areas first, sidewalks second and street the last. Manholes shall not be located in parking spaces. Handholes and manholes in streets, immediately adjacent to and within 4.9 m (16 ft.) of a street shall meet Department of Transportation standards associated with the project/campus.
5. **Grading:** Grade surrounding grass areas to drain away from the manhole cover.

**B. Other Requirements:** In addition, manhole installation shall comply with the following requirements:

1. **Cable Mounting:** Rack all cables on heavy duty non-metallic cable racks designed for installation on all walls of manholes to accommodate a full loop of cable inside the manhole.
2. **Pulling Irons:** Provide pulling irons opposite all ductbank entrances.
3. **Sump:** Provide a sump, in-line with a manhole cover, approximately 305 mm x 305 mm x 152 mm (12 in. x 12 in. x 6 in.) deep at all manholes so that a pump can be lowered into the sump without entering the manhole.

***Rationale:** This allows water to be pumped out of manholes without requiring personnel to enter the manhole.*

4. **Manhole Grounding:** In each manhole, provide a 3 m (10 ft.) long, 19 mm (3/4 in.) diameter copper-clad steel ground rod through the floor of the manhole; connect all metallic components in the manhole, such as racks, cable sheaths, pulling irons and ladder to that ground rod with a #6 American Wire gauge (AWG) green insulated cable. Exothermically bond ground rod to the #4/0 ductbank ground conductor.

# Section 10.5

## Wiring Methods and Other Requirements

---

### Contents

10.5.0 Introduction

10.5.1 Conductors and Cables

10.5.2 Raceway

10.5.3 Wiring Devices

10.5.4 Other Requirements

10.5.5 Laboratory and Animal Research Facility

## 10.5.0 Introduction

The intent of this section is to specify requirements for conductors, conduit, wiring devices, and other requirements that need to be followed in all new or renovation projects.

### 10.5.1 Conductors and Cables

**A. Medium Voltage Cable:** All medium voltage cable installation shall meet the following requirements:

1. **Cable Specification:**
  - a. **Cable Type:** MV 105
  - b. **Conductor:** Copper, single conductor
  - c. **Insulation:** Ethylene-propylene rubber (EPR)
    - i. **Voltage Rating:** 15 kV
    - ii. **Insulation Level:** 133% insulation level
  - d. **Strand screen:** Extruded semiconducting EPR meeting or exceeding the electrical and physical requirements of ICEA S-68-639, AEIC CS8, and UL 1072
  - e. **Shielding:** Copper tape, 5 mils thick, helically applied with a 12.5% overlap
  - f. **Cable Assembly:** Three insulated, shielded conductors cabled together with a ground conductor
  - g. **Cable Jacket:** Sunlight-resistant PVC
  - h. **Cable Size:** 350 KCmil or 500 KCmil. 500 KCmil is preferred for new construction in the NIH Bethesda campus.

***Rationale:** This is to maintain NIH short circuit study and possibly serve multiple buildings by a single feeder.*

2. **Cable Termination:** Termination materials shall be compatible with the cable supplied.

3. **Cable Splice:** Splice all cables to completion without any interruption using customized splicing kits from a reputable cable manufacturer. Splices shall be custom made at each site by an experienced cable splicer.

***Rationale:** This is to ensure that splicing of cable will meet the reliability standards of the NIH.*

4. **Existing Cable:** The typical existing medium voltage cable at the NIH Bethesda campus is paper-insulated lead-covered (PILC) cable, compact-sector, 100% insulation, and shielded with the lead sheath, which is grounded in each manhole. Splice PILC cable with only PILC cable with similar physical and electrical characteristics.

***Rationale:** This is to restrict splicing of existing PILC cable with PILC cable only.*

5. **Cable Identification:** Label cables in manholes with embossed brass cable tags and brass chains.
6. **Cable Testing:** Perform insulation test of cables with all splices and pothead terminations while not connected to switchgear or any other equipment. Repair or replace cables if cable testing result does not meet specification requirements.

**B. Conductors and Cable (600 V or less):** General requirements for building wires and cable rated 600 V or less are as follows:

1. **Conductor Material:** Copper conductor except for lightning protection systems. Lightning protection systems (except for down conductors) may utilize aluminum conductors.
2. **Insulation:** THW or THWN or THHN insulation

*(T = thermoplastic; H = heat resistant; HH = high heat resistant; W = water resistant; N = nylon coating).*

Isolated power branch circuits shall have conductors with orange and brown XHHW insulation.

**Rationale:** *This is to reduce leakage current.*

3. **Voltage Drop:** Maximum branch circuit voltage drop shall be limited to 3% and feeder voltage drop shall be limited to 2% at full load.
4. **Minimum Wire Size:** #12 American Wire gauge (AWG) except for dedicated special-purpose circuits, where minimum wire size shall be #10 AWG. Adjust wire size with considerations to voltage drop and ambient temperature.
5. **Neutral:** Provide dedicated neutrals for all 120 V receptacle circuits. Multi-wire shared neutral conductor size for 20 A circuit of wired modular furniture shall be minimum #10 AWG and protected in accordance with NEC.
6. **Conductor Quantity:** No more than three single-phase circuits or six current-carrying conductors shall be installed in a conduit.

**Rationale:** *This is to limit simultaneous outages and increase in conductor sizes due to increased heating of cables.*

**C. Cable Identification:** Identify all power and signal conductors. Identification of cables shall follow the requirements below:

1. **Power Conductor:** All branch circuit conductors shall have colored insulation. For larger-sized conductors, provide appropriate color tape (minimum 152 mm [6 in.] wide) around the conductor at the cable end. Color-code each conductor of multiconductor cable in the same manner as the single conductors. Color coding of power conductors is as given in [Table 10.5.1](#).
2. **Control Wiring:** For all control system wiring, provide permanent, numbered tape markers at both ends of the cable and at splice points of each conductor. Tape markers shall be uniform in color.

**Note:** Parallel feeders shall be marked with the number of the feeder set on both ends of the conductors. Medium voltage cables shall be marked with feeder number and cable size.

**Table 10.5.1 Color Coding for Wire Insulation**

Power Conductor	208/120 V	480/277 V	5/15 kV
Phase A	Black	Brown	Brown
Phase B	Red	Orange	Orange
Phase C	Blue	Yellow	Yellow
Neutral	White	Grey	Grey
Ground	Green	Green	Green
Isolated ground	Green with yellow tracer	Green with yellow tracer	NA
Isolation monitor panel	Orange and Brown	NA	NA

NA = Not applicable.

**D. Temporary Wiring:** Temporary wiring when required shall follow the installation requirements below:

1. **Construction Method:** For a construction period of less than a year, use temporary wiring methods for all power system circuiting except for lighting. Install temporary wiring for construction that has construction schedule exceeding a year per permanent wiring methods.

**Rationale:** *This is to limit use of temporary wiring to preclude any hazards arising from such wiring systems as they are meant to last only for short duration.*

2. **Removal:** Remove all temporary wiring including temporary lighting prior to the end of construction.

**Rationale:** *This is to limit inadvertent use of temporary wiring in future.*

**E. Branch Circuit Loading:** Lighting branch circuit load shall be limited to 1,400 VA for 120 V circuit and 3,200 VA for 277 V circuit. Provide full size separate neutrals for all lighting circuits. General purpose receptacle circuit load (unless mentioned otherwise) shall be limited to 1,080 VA.



**Rationale:** *This is to allow future circuit additions.*

**F. Wiring:** Wiring termination and other requirements are as follows:

1. **Wiring Terminations:** Wiring termination temperature ratings shall be strictly based on overcurrent protective device ratings.
  - a. Circuits 100 A or less shall comply with conductors rated at 60°C (140°F). Circuits rated over 100 A shall comply with conductors rated 75°C (167°F).
  - b. Wiring terminations shall be suitable for both aluminum and copper when dry-type transformer with aluminum winding is used.
2. **Multi Wire Branch Circuit:** Multi-wire branch circuit shall have a common disconnecting means in accordance with NEC 210.4(B).
3. **Isolated Ground Circuit:** Where isolated ground (IG) circuits are required, provide an IG conductor (in addition to an equipment ground conductor) with the branch circuit.
4. IG conductor shall be sited the same as the phase conductor.

## 10.5.2 Raceway

**A. Conduit:** Install all wiring, including low voltage system wiring, in conduit except as noted elsewhere in this document. In addition, comply with the following requirements:

**Table 10.5.2(A) Conduit Size Imperial to Metric Transition**

Inches	Millimeters	Inches	Millimeters
.5	16	2.5	63
.75	21	3	78
1	27	3.5	91
1.25	35	4	103
1.5	41	5	129
2	53	6	155

1. **Size:** Size raceways considering all adjustment factors noted in NEC. Nominal imperial to metric transitions for conduit are given in [Table 10.5.2\(A\)](#).
2. **Conduit Type:** Conduit shall be metallic. PVC or aluminum conduit is not acceptable except as noted elsewhere in this manual.
3. **Minimum Conduit Size:** The minimum conduit size is 21 mm (3/4 in.) for power system wiring (600 V or less); 27 mm (1 in.) for telecommunication system wiring; 129 mm (5 in.) for medium voltage wiring; 16 mm (1/2 in.) is acceptable for a branch circuit with two #12 AWG current carrying conductors and one #12 AWG equipment ground wire; 16 mm (1/2 in.) flexible metal conduit (FMC) is acceptable for lighting fixture whips consisting of one phase, one neutral, and one ground wire.
4. **Fittings:** Fittings for the metallic conduits shall be compression type steel or malleable iron.
5. **Direct Buried Cable:** Direct burial of power and signal cables is not permitted. Where an existing direct-buried street lighting circuit is being extended to one or two poles, the circuit may be direct buried. Where the cable is direct buried, protect entire length of the cable by 25 mm × 152 mm (1 in. × 6 in.) nominal pressure treated lumber installed at 152 mm (6 in.) above the cable. The cable burial depth shall be 762 mm (2 ft. 6 in.) below grade.

**Rationale:** *This is to limit direct burial of cable as such installation compromises reliability of service.*

**B. Conduit applications:** Conduit types in all areas except animal research facilities (ARFs) shall comply with the following requirements:

1. **Electrical Metallic Tubing (EMT):** Installed indoors in areas not subject to physical damage when allowed by code.
2. **Rigid Galvanized Steel Conduit (RGS):** Installed indoors in areas subject to physical damage, in elevator shafts, outdoor feeders

exposed or concealed, conduits larger than 103 mm (4 in.) and where exposed within 3 m (10 ft.) of the finished floor level. RGS conduit may be substituted for schedule 40 PVC.

3. **Flexible Metal Conduit (FMC):** Connection to lighting fixture (whips). Conduit length is limited to 1.8 m (6 ft.) maximum and 457 mm (1 ft. 6 in.) minimum.
4. **Liquid-tight Flexible Metal Conduit (LFMC):** Connection to vibrating equipment. Conduit length is limited to 1.8 m (6 ft.) maximum and 457 mm (1 ft. 6 in.) minimum.
5. **Metal clad (MC) Cable:**
  - a. MC cables are acceptable for power (receptacle, wiring devices, and lighting) branch circuits in administrative and public spaces only.
  - b. MC cabling is not allowed for use in laboratories or ARFs.
  - c. MC cabling is not allowed for use in mechanical, electrical, or telecommunications rooms.
  - d. Where allowed, MC cabling shall not be used for circuiting homeruns to panelboards.

***Rationale:** Limiting the use of MC cable is to allow for future tracing of circuiting routes, alleviate inspection for required supporting of cables, and allow for future addition of additional circuits to same general area within existing conduits.*

6. **PVC Conduit: Installed underground.** PVC conduit shall be minimum type EB if concrete encased, or schedule 40 if direct buried. Schedule 80 may be used per [Section 10.4.1 Distribution Duct Systems](#) for exterior low voltage (600 V or below) branch circuit conduits.

**C. Conduit Installation (within buildings):** Conduit installed within buildings shall comply with the following requirements:

1. **Routing:** Install all conduits parallel or perpendicular to the building features except for the

conduit routed inside or under the slab. Do not install conduit within a slab on-grade.

2. **Support:** Support all conduits with approved devices independent of other systems and equipment. Tie wire is not acceptable. Do not attach conduit to box covers except 16 mm (1/2 in.) or smaller flexible conduit terminated on a flush mounted box cover.
3. **Transition:** Conduit stubbed out of floors shall transition to RGS raceway prior to the point where the conduit is exposed. Provide RGS elbow when elbows are terminated above slab.
4. **Identification:** Identify all service and feeder conduits with machine made labels every 15.2 m (50 ft.) indicating their use.

**D. Conduit Installation (Underground):** Conduit installed underground shall comply with the following requirements:

1. **Medium Voltage Applications:** Conduits for medium voltage applications shall be concrete encased.
2. **Direct Buried Conduit:** Direct buried conduit is acceptable for electrical systems rated 600 V and below.

***Exception:** Conduits shall be concrete encased when buried beneath roadways.*

Direct buried RGS conduit shall be coated with asphalt paint or PVC

3. **Cover:** Install buried conduit at a minimum 762 mm (2 ft. 6 in.) below grade.
4. **Marking:** For underground systems wiring, install metallic foil-backed plastic cable marking tape, 152 mm (6 in.) wide, at 305 mm (1 ft.) below grade above the conduit run. The plastic marking tape shall be red or yellow and read "CAUTION: BURIED ELECTRIC LINE."

***Rationale:** This is to protect conduit from accidental digging.*

- 5. Empty Conduits:** Provide a minimum 4 mm (3/20 in.) diameter nylon pull wire for pulling future cables for all empty ducts; seal all empty ducts to prevent water seepage into the handhole or manhole; slope all ducts to prevent water drainage into the building.

*Rationale: This is to facilitate future installation and protect feeder from water damage.*

- 6. Existing Conduit:** Prior to pulling cable into any existing conduit, the conduit shall be cleaned with a wire brush 13 mm (1/2 in.) larger than the duct and rodded with a mandrel 8 mm (3/10 in.) smaller than the duct to test the integrity of the duct.

*Rationale: This is to limit damage to cable insulation from abrasion of dirt and debris.*

**E. Cable Pulling:** Design raceway systems so that the calculated cable pulling tensions and sidewall pressures will not exceed the manufacturer’s recommendations. Conduit runs within building shall not exceed more than 61 m (200 ft.) for straight pull. Reduce length by 15.2 m (50 ft.) for each bend of 90°. Total amount of bends between pull points shall not exceed 270°.

**F. Cable Tray:** With NIH approval, dedicated cable tray may be used for communications wiring or for racking medium voltage cabling. Neither power nor signal cables are allowed in dedicated telecommunication cable trays.

**G. Surface Metal Raceway (SMR):** SMR installation shall comply with the following requirements:

- 1. Metal Type and Dimension:** SMR shall be metallic – steel, stainless steel, or aluminum. Non-metal surface raceway is not acceptable. The nominal dimensions for SMR are as given in Table 10.5.2(B).

*Rationale: This is to provide a redundant equipment grounding path and restrict the use of non-metallic raceways as they are prone to damage from physical abuse.*

- 2. Applications:** Use of modular SMR is limited to dry locations. Installation of SMR in environmental rooms is prohibited.

*Rationale: This is to limit the use of SMR in tempered environment only.*

- 3. SMR with Dividers:** Normal power circuits and communication cabling are allowable in the same SMR provided with dividers. SMR with dividers is not acceptable for routing of emergency circuits with normal circuits.

*Rationale: This is to provide greater reliability of electrical service and preclude simultaneous disruption of both normal and emergency electrical service.*

- 4. Circuit Breaker:** Either a 60 A, 3-phase, 4-wire system with integral circuit breakers or individual receptacle circuits fed from local branch circuit panelboards may be provided.
- 5. Circuit Taps:** When SMR with integral circuit breakers is used, complete the taps in raceway using three-ganged, 20A single pole circuit breakers in a common circuit breaker housing.
- 6. Receptacle:** Install receptacles in SMR at a 610 mm (2 ft.) on center unless otherwise indicated on contract drawings. Connect these receptacles to alternating circuits – phase balanced with no more than four receptacles per circuit.
- 7. Specialty Equipment:** Dedicated circuit for specialty equipment shall use separate device box and may utilize SMR circuiting.

**Table 10.5.2(B) Surface Metal Raceway Dimensions**

Raceway Type	Dimensions (Width x Depth)
Single channel	70 mm × 38 mm (2.75 in. × 1.5 in.)
Two channel	121 mm × 44 mm (4.75 in. × 1.75 in.)
Two channel	121 mm × 89 mm (4.75 in. × 3.5 in.)

***Rationale:** This is to provide flexibility of connection of different lab equipment.*

### 10.5.3 Wiring Devices

**A. Device Boxes:** Boxes for interior electrical systems shall be hot-dipped galvanized steel or malleable iron and shall be compatible with the raceway system.

**B. Switches and Receptacles:** General requirements for switches and receptacles are as follows:

1. **Type:** All wiring devices shall be minimum specification grade. Wiring devices installed in patient care areas shall be hospital grade.
2. **Toggle Switch:** Toggle switches used to control lighting shall be specification grade, rated for use in both 120 V and 277 V circuits, and rated for a minimum of 20 A.
3. **Duplex Receptacles:** Duplex receptacles shall be rated for 20 A at 125 V, be polarized parallel-blade type with ground, and have NEMA 5-20R configuration.
4. **Tamperproof Receptacles:** Tamperproof receptacles, where required, shall be NEMA 5-20R safety type that operates with either a two or three-bladed plug.
5. **Ground Fault Circuit Interrupter (GFCI) Receptacles:** Receptacles installed outdoors or within 1.8 m (6 ft.) of sources of water shall be GFCI type. Do not use GFCI receptacles to protect downstream receptacles except for receptacles located in the same room.
6. **Bracket and Terminal:** Receptacle mounting brackets shall be extra heavy and the terminals shall be copper alloy, side wired.
7. **Receptacle Orientation:** Install vertically mounted receptacles so that the ground prong is in the up position for receptacles mounted up to 1.5 m (5 ft.) above the finished floor. Horizontally orientated receptacles mounted up to 1.5 m (5 ft.) above the finished floor shall have the neutral blade facing up and ground pin facing left.
8. **Cover Plates:** Cover plates for building interior receptacles, switches, and boxes shall be stainless steel, brushed aluminum, or hospital-grade impact-resistant nylon. Cover plates for cast boxes shall be gasketed and weatherproof.
9. **Design Load:** Design load for the general-purpose receptacles shall be 180 VA each; connect maximum of six receptacles to a circuit.
10. **Computer and Printer Outlets:** Provide dedicated circuits, not connected to any other types of loads, for both computer and laser printer outlets. Limit four personal computers (PCs) to any single 20 A circuit. Limit two laser printers to any 20 A circuit. These circuits shall have dedicated neutral conductors. PC and laser printer quantity restrictions shall also apply to wired modular furniture.
11. **Outlets Required:** Provide outlets in all spaces in accordance with NEC, program requirements, and other requirements listed below.
  - a. If no furniture plan is provided, provide a minimum of one general purpose receptacle per wall in offices, copy rooms, conference rooms, and similar spaces. Provide IG receptacles in offices based on the program direction. Provide additional outlets above counter for each 914 mm (3 ft.) (or fraction thereof) of counter spaces.
  - b. **Computer Receptacle:** Provide a computer receptacle connected to a dedicated circuit at the following locations:
    - i. **Enclosed Offices:** Based on proposed furniture layout, provide a double-duplex computer receptacle to serve suggested computer location.
    - ii. **Open Office Workstations:** Provide at least one double-duplex receptacle at each location.
    - iii. **Conference Rooms:** Provide at least one wall receptacle and one floor receptacle. Locate a floor outlet centered under the conference room table location.

- c. **Office Spaces:** Provide at least four receptacles per office. One of these receptacles is intended for housekeeping. Place housekeeping receptacle on wall adjacent to the entry door to the office space.
  - d. **Open Office Workstations:** Provide minimum two receptacles and additional receptacles so that no point in any wall panel space is more than 1.8 m (6 ft.) away from a receptacle.
  - e. **Conference/Training Rooms:** Similar to the office space. In addition, provide outlets for audio-visual equipment and power connection for motorized projections screens as well as motorized shades.
  - f. **Corridor:** Provide 20 A receptacles on dedicated circuits for custodial use along the corridor wall so that any point on the corridor floor is no more than 7.6 m (25 ft.) from a custodial receptacle. Custodial receptacles shall be on dedicated circuits and not shared with any program space receptacles.
  - g. **Copy/Printer Room:** Provide at least one dedicated 20A receptacle for a copy/printer. Some copy/printer rooms may require additional outlets of different configurations.
  - h. **Storage Room:** Provide minimum one receptacle adjacent to door and additional receptacles in equipment rooms so that all equipment that may require maintenance is within 7.6 m (25 ft.) of a receptacle.
  - i. **Electrical room/closet and Mechanical Room:** Provide at least two receptacles with one connected to emergency power per [Section 10.3.1 Emergency Electrical Systems](#) and the other one connected to normal power.
  - j. **Toilet Rooms:** Provide at least one GFCI receptacle at the vanity or sink. Coordinate exact location with toilet accessories.
  - k. **Service Outlets:** Provide a 20 A duplex GFCI receptacle within 7.6 m (25 ft.) of any electrically operated equipment on rooftops, in attics, and in crawl spaces. These receptacles shall be on the same level and shall be on a circuit separate from the circuit serving the equipment.
- 12. **Plug Load Control:** Occupancy or time-schedule based control shall be considered for plug loads for office cubicles and private workstations.
  - 13. **Safety Showers:** Light switches and receptacles installed in close proximity to the safety showers shall be provided with gasketed and weatherproof covers. The receptacles shall be GFI type.
  - 14. **Plumbing Fixtures:** For automatic flush valves, faucet sensors, and paper towel dispenser in restrooms, provide a 120 V, 20 A dedicated emergency circuit for each group of fixtures except for self-charging, battery-powered flush valves and faucets required in the Building 10 complex on the NIH Bethesda campus.
  - 15. **Design Documentation:** Indicate NEMA configuration for all receptacles on the drawings.

---

## 10.5.4 Other Requirements

**A. Disconnects:** General requirements of disconnect switches are as follows:

- 1. **Type:** All disconnect switches shall be heavy-duty type.
- 2. **Mounting:** Disconnect switches shall have a minimum clear mounting height of 610 mm (2 ft.) above grade for outdoor installation and 1.1 m (3 ft. 6 in.) above finished floor for interior installation.

**B. Nameplates and Circuit Identifications:** Provide nameplates and circuit identifications in accordance with following requirements and other requirements mentioned elsewhere in this manual.

- 1. **Nameplate:** All electrical equipment (e.g., disconnects, starters, etc.) shall have nameplates with NIH Facility Numbers (FAC #). Coordinate exact NIH Facility Numbers for the electrical



equipment with the PO.

- a. Provide nameplates (in small letters) on the equipment with phrase “FED FROM” followed by the source panel and circuit number to identify the electrical power source of the equipment.
  - b. Nameplates shall be laminated phenolic legend plates with white letters on black background for normal power and white letters on red background for emergency power.
  - c. Nameplates shall have minimum 6 mm (1/4 in.) high letters for small equipment and disconnects; minimum 13 mm (1/2 in.) high letters for medium-sized wall-mounted equipment such as panelboards, individual starters of size 2 and higher; minimum 51 mm (2 in.) high letters for freestanding equipment such as large distribution panelboards, switchgear, and liquid filled transformers.
  - d. Attach the nameplates with stainless steel screws.
2. **Circuit Identification:** Provide printed laminated tape or engraved or labels on cover plates of wiring devices, including receptacles, light switches, junction boxes and pull boxes, identifying the panelboard source and circuit number. In addition, provide phase sequence for the receptacles installed in the SMR.

Receptacles for computers and printers shall be provided with engraved cover plates or nameplates identifying their specific use riveted to the cover plate.

Identify wiring devices according to power source, i.e., normal power or emergency power. Wiring devices on emergency power shall be red in color.

**C. Demolition:** Demolition of existing electrical system shall comply with the following requirements:

1. **Empty Conduits:** Remove all empty conduits that are not embedded in concrete or scheduled

to be reused in new construction. Otherwise, abandon the conduits in place.

***Rationale:** This is to require removal of unused equipment that would clutter areas and would not be known as available for future reuse.*

*The following exceptions apply:*

- a. *The lighting switch leg conduit connected to the first outlet box if the wall containing the switch is to remain.*
  - b. *The vertical conduit connected to the first outlet box at the panelboard if the panelboard is of the recessed type.*
2. **Repair:** Cut the conduit passing through slab from above after the wire has been removed with a cold chisel at least 6 mm (1/4 in.) below the slab elevation; then, seal the conduit and enlarged opening with non-shrinking grout with the slab surface finished flat and true. Cut the conduits penetrating slab from below, after the wires have been removed, as close as possible, with no more than 19 mm (3/4 in.) protrusion below slab.

**D. Telecommunication and Audiovisual Systems:** Refer to [Section 11.2](#) for electrical requirements of the telecommunication systems and refer to [Section 11.5](#) for conduit and boxes requirements of the audiovisual systems.

## 10.5.5 Laboratory and Animal Research Facility

Other specific requirements for electrical installation in laboratory and animal research facilities (ARFs) are as follows:

**A. Dedicated Panel:** Provide dedicated branch circuit panelboards for laboratories and animal research facilities.

**B. Dedicated Circuit** Provide dedicated circuits for all refrigerators, freezers, centrifuges, and other specialty



laboratory equipment. Connections to specialized equipment (i.e., autoclaves, surgical lamps, cage washers, etc.) shall comply with equipment manufacturers' instructions.

**C. Wires (ARF Operating Room):** Wires for animal research facility operating room circuits shall be minimum #10 AWG with XHHW insulation.

**D. Alarm and Monitoring:** Provide monitoring and alarm notification in laboratories and ARFs via building automation system (BAS) or standalone system. Perform a cost analysis to justify the use of BAS or stand alone system. The monitoring system shall have the ability to generate reports without the use of proprietary software.

**E. Conduit Applications – ARF:** Conduit types in ARF shall comply with the following requirements:

1. **RGS:** Exposed in ARFs and wash down areas
2. **EMT:** Installed indoors in areas not subject to physical damage when allowed by code
3. **Intermediate Metal Conduit (IMC):** Wash down areas
4. **Non-ferrous or Aluminum Conduit:** Magnetic field (i.e., magnetic resonance imaging [MRI], nuclear magnetic resonance [NMR]) areas. Possible restrictions may apply to aluminum conduit due to radio frequency (RF) interference.
5. **Metal clad (MC) Cable:** MC cabling is not allowed for use in animal research facilities.

**F. Conduit Installation – ARF:** Conduit installation in ARFs shall comply with the following requirements:

1. **Penetrations:** All conduit penetrations through walls in animal research facilities shall be completely sealed. See [Appendix L: Sealant Table](#).
2. **Concealed:** Conduits installed in ARFs shall be concealed unless impractical.
3. **Surface Mounted:** When conduits are required

to be surface mounted, surface-mounted conduits shall be secured with 19 mm (3/4 in.) standoffs or sealed on both sides to adjacent surfaces with continuous beads of silicone caulking.

4. Provide dedicated emergency outlets along corridors in ARFs for connection of portable emergency equipment.

**G. Device Boxes:** In animal research facilities, use cast boxes with external hub and gasketed device cover plates; provide 25 mm (1 in.) barrier of silicone caulking around the wire within the device box hub; and provide a continuous bead of silicone caulk around the device cover plate and the adjacent surface. If device boxes are surface mounted on RGS conduit, all sides shall be sealed to adjacent surfaces with a continuous bead of silicone caulk. See [Appendix L: Sealant Table](#).

**H. Switches and Receptacles:** Switches and receptacles installed in laboratories and ARFs shall comply with the following requirements:

1. **IG Receptacle:** Provide IG receptacles in laboratories and offices based on the program direction.
2. **Ventilated Animal Racks:** Receptacles for power ventilated animal racks shall be twist-lock NEMA L5-20R or NEMA 5-20R hospital grade at program discretion.
3. **GFCI Outlets:** Provide GFCI receptacles within 1.8 m (6 ft.) of sinks, or other sources of water. These GFCI receptacles do not include outlets for cup sinks, outlets for local water polishing near the sinks, or receptacles dedicated for specific pieces of equipment.

Provide weatherproof, GFCI-type receptacles in animal research facilities where they are exposed to water.

4. **Coverplate:** Provide weatherproof covers for receptacles and switches where they are exposed to water. Utilize stainless steel coverplates for switches and receptacles in room that will utilize vaporized paraformaldehyde or chlorine dioxide gaseous decontamination protocols.

# Section 10.6

## Power Quality and Grounding

---

### Contents

10.7.0 Introduction

10.7.1 Lighting Design Guidelines

10.7.2 Interior Lighting

10.7.3 Exterior Lighting

10.7.4 Lamps

10.7.5 Lighting Control

10.7.6 Animal Research Facility Lighting and Controls

## 10.6.0 Introduction

Power quality is an increasingly important parameter that impacts productivity and research at the NIH. In designing new electrical systems or in major renovations, power quality issues must be addressed to ensure proper operation of all sensitive electronic equipment including research lab equipment, networking equipment, computer, etc.

### 10.6.1 Harmonics

**A. Harmonic Control Measures:** Variable Frequency Drives (VFDs), electronic ballasts, LED drivers, uninterruptible power supplies (UPS), computers, laser printers, and other electronic equipment are known to be harmonic generators (non-linear loads). Perform a power system analysis to determine if mitigating measures are required when a large number of harmonic generators are anticipated. These mitigating measures may include oversizing the transformers serving the harmonic loads, specifying k-rated transformers, specifying harmonic filters, oversizing neutral conductors, etc. When 50% or more of the load is non-linear, provide the following:

1. K-13 rated transformers with 200% neutral conductor from transformer to panel
2. Branch circuit panelboards with 200% neutral buses
3. Active harmonic mitigation filters/devices

*Rationale: This is to minimize deleterious impacts of the harmonic current on the electrical power distribution systems.*

**B. Sensitive Electronic Equipment:** Sensitive electronic equipment may be prone to common mode noise. In general, low voltage electrical distribution shall meet the following requirements:

1. Connect large motors and power loads to separate service or feeders from the ones supplying sensitive electronic equipment.

2. Provide separate feeders for each panelboard serving the sensitive equipment; do not tap from a common feeder riser.

To further mitigate the impact of common mode noise on sensitive electronic equipment, provide isolation transformers, electronic power distribution panelboards, or power conditioners to serve critical electronic equipment loads.

### 10.6.2 Uninterruptible Power Source

UPS systems may be required in some facilities to serve information technology/server equipment and other equipment per facility program requirements. Coordinate UPS size, location, critical load connected to UPS, and other requirements with an NIH technical representative. UPS installation shall comply with the following requirements:

1. **Generator Available:** Where centrally provided UPS is backed up by a generator, the generator must provide power to all auxiliary equipment, lighting, air conditioning equipment, and ventilation of the UPS room.
2. **Redundancy:** Coordinate system redundancy requirements with NIH technical representative.
3. **Spare Capacity:** UPS systems shall have spare capacity to meet future program requirements. Large UPS shall have modular expansion capability.
4. **Maximum Demand:** The maximum demand load of a UPS shall not exceed the UPS manufacturer's recommended value.
5. **Wet Cell, Non-sealed Battery Type:** Provide proper ventilation, emergency lighting, hydrogen detection, spill containment, working clearance for UPS battery room when wet cell, non-sealed battery types are used.
6. **Alarm and Monitoring:** System status panel shall include an audiovisual alarm feature to alert the operator. In addition, provide a remote

alarm at the space served by the UPS and interface to building automation system (BAS) to indicate alarmed condition. Alarm and monitoring shall include:

- a. System “On,” system “Bypassed,” system “Fault”
- b. Out of phase utility fault
- c. Generator “Run” status

### 10.6.3 Transient Voltage Surge Suppression

**A. Service Entrance:** Provide ANSI/IEEE Standard C62.41 compliant category C3 Transient Voltage Surge Suppression (TVSS) protection at the service entrance when a lightning protection system is required. Refer to [Section 10.2.2.2 Secondary Voltage Service Equipment](#).

**B. Branch Circuit Panel:** If very sensitive electronic equipment is present, the A/E shall consider providing a layered TVSS protection plan with category B3 TVSS protection at the downstream branch circuit panels.

**C. Surge Protector:** Provide properly sized surge protectors for all medium voltage transformers, medium voltage motors, medium voltage distribution cables, telephone equipment, fire alarm control panel, and security system monitoring panel.

### 10.6.4 Grounding

The grounding system plays a major role in ensuring the safety of personnel and proper operation of sensitive electronic equipment. The ground system comprises ground grids, grounding electrodes, and metallic structures, forming an equipotential ground plane.

**A. Ground System Resistance:** Provide a solid grounding electrode system to ground the service entrance equipment. Electrical service ground system resistance shall be as follows:

1. Service rated less than 2500 kVA: 5 ohms

2. Service rated 2500 kVA or larger: 1 ohm

Perform grounding electrode resistance testing in accordance with IEEE Standard 141.

**Note:** Conduct soil resistivity testing early in the design because soil resistivity varies from site to site.

**B. Domestic Water Service:** Electrically connect electrical service ground to the incoming domestic water services provided the piping for water services is a conducting material.

**C. Ground Ring:** Ground ring installation shall comply with the following requirements:

1. **Transformer Pad, Main Electrical Room and Transformer Vault:** Provide a ground ring of #4/0 AWG bare copper conductors, exothermically welded to copper-clad ground rods (minimum 3 m [10 ft.] long and 19 mm [3/4 in.] diameter), around the transformer pad (if installed) and the main electrical room or indoor transformer vault.
2. **Building:** When lightning protection is required or provided, provide a ground grid of #4/0 AWG bare copper conductors, exothermically welded to copper-clad ground rods (minimum 3 m [10 ft.] long and 19 mm [3/4 in.] diameter), encircling the entire building.
3. **Ground Rod Spacing:** The ground ring around the transformer shall have ground rods installed approximately 914 mm (3 ft.) outside each corner of the pad. The main electrical room and building ground ring shall have ground rods with maximum spacing of 6.1 m (20 ft.) between them.
4. **Exothermic Weld:** Perform all underground connections using exothermic welds and utilizing the appropriate tool as recommended by the manufacturer.
5. **Test Well and Monitoring:** Provide ground test wells at accessible locations. Provide an active ground monitoring system connected to the BAS system to continuously monitor the integrity of the grounding system.

**D. Transformer Grounding:** Ground each transformer enclosure with two #4/0 AWG conductors connected to the transformer ground ring at separate locations. Refer to [Section 10.2.2.2 Secondary Voltage Service Equipment](#).

**E. Ground Bus:** Unless otherwise indicated, provide a copper ground bus mounted 610 mm (2 ft.) above a finished floor, on insulators 51 mm (2 in.) from the wall, at the following locations to provide a common ground point throughout the building:

1. **Main Electrical Room:** One ground bus, 6 mm × 51 mm × 2,438 mm (1/4 in. × 2 in. × 96 in.), at the long access wall
2. **Electrical Closets/Rooms:** One ground bus, 6 mm × 51 mm × 610 mm (1/4 in. × 2 in. × 24 in.) at an accessible location. Connect this bus to the main electrical room ground bus via a continuous #4/0 bare copper express ground riser. Provide a #4/0 bare copper ground conductor from each closet ground bus exothermically welded to vertical express ground riser, routed through stacked electrical rooms to provide a continuous grounding connection between the closets.
3. **Electrical rooms dedicated for emergency power distribution equipment and generator rooms:** One ground bus, 6 mm × 51 mm × 610 mm (1/4 in. × 2 in. × 24 in.) at an accessible location. Connect this bus to the main electrical room ground bus via #4/0 bare copper wire.
4. **Main Communication Room:** One ground bus, 6 mm × 51 mm × 610 mm (1/4 in. × 2 in. × 24 in.) at an accessible location. Connect this bus to the main electric room ground bus with an insulated #2/0 copper ground wire.
5. **Communication Closets/Rooms:** One ground bus, 6 mm × 51 mm × 610 mm (1/4 in. × 2 in. × 24 in.) at an accessible location. Connect this bus to the main communication room or to a nearest communication closet ground bus with an insulated #2/0 copper ground wire.

**F. Main Electrical Room Ground Bus:** Connect two #4/0 AWG ground conductors from each of the transformer ground ring, electrical room ground ring, and building ground ring (provided for lightning protection

systems) to each end of an accessible, wall mounted main electrical room ground bus. Ground conductors leading to the ground ring shall be exothermically welded to the ground bus; all others shall be bolted.

*Rationale: This is to create single ground system, providing equipotential ground plane.*

**G. Metal Structure and Objects:** Ground all structural steel. All exposed metallic structures such as light poles, aerial structures, electrical equipment protective steel bollards, and manhole/handhole covers shall be connected to a grounding conductor and grounded to separate grounding electrodes. Bond all metallic objects crossing the ground grid to the ground grid.

*Rationale: This ensures that any accidental contact between a current carrying conductor and the metal object would have the fault cleared by the associated overcurrent protection device.*

**H. Substation Fence:** Bond fence enclosures around or adjacent to substations to ground ring with #4/0 AWG ground conductor at 15.2 m (50 ft.) intervals. Bond gates and fence openings to grounding electrodes with flexible braid to provide grounding continuity.

**I. Raised Floor:** All raised floors must be grounded. Bond every fourth floor pedestal to the communication room common ground bus.

**J. High Frequency Signal Reference Ground:** A high frequency signal reference ground for radiofrequency noise mitigation may be required. If this is required, provide a 610 mm (2 ft.) on center copper signal reference grid. Bond the high frequency signal reference grid to the main electrical service ground.

**K. Other Requirements:** In addition, grounding system shall comply with the following requirements:

1. **Conductor Size:** Use bonding conductors that are not smaller than the grounding electrode conductor in accordance with NEC and not smaller than #6 AWG copper.
2. **Equipment Ground:** Provide green, insulated equipment grounding conductors sized in accordance with the NEC for all feeders and branch circuits, including switch legs.

3. **Isolated Ground:** Provide isolated ground (IG) sized the same as the phase conductors for equipment sensitive to external interferences from other sources (coordinate equipment requirements with an NIH technical representative). Connect the IG conductor from the equipment to panelboard IG bus and do not bond panelboard IG bus to the panelboard's enclosure or the equipment ground bus. The IG conductor must be connected to the main grounding system only at the separately derived power source's ground point.
4. **Protection:** Do not locate ground conductors in traffic areas or in areas subject to damage. Provide PVC conduit sleeves for ground conductor penetrations through the floor or walls. When ground leads through the floor become susceptible to damage due to layout changes, the PVC sleeve shall be cut off flush with the floor. Place a steel "C" channel face down over the penetration to form a protective bridge; bolt the "C" channel to the floor with the ground wire exiting one end.
5. **Label:** Label all grounding electrode conductors using embossed brass metal tags with nylon tie wraps.
6. **Ductbank Grounding:** Refer to Sections 10.4 and 11.4 manhole and ductbank grounding requirements.
7. **Load Bank Grounding:** Refer to Section 10.3.2 Emergency Power Generation.

## 10.6.5 Lightning Protection

**A. Evaluation:** Evaluate the need for lightning protection in new buildings at the NIH campus by performing risk analysis in accordance with the latest NFPA 780, lightning protection standard. Provide lightning protection when the risk analysis indicates a moderate or higher risk.

**Note:** Low height buildings may be protected by a lightning protection system installed at an adjacent taller building in accordance with the standards.

**B. General Requirements:** Lightning protection systems installation requirements are as follows:

1. **Standard:** Lightning protection systems shall meet the most restrictive requirements of NFPA 780, Lightning Protection Institute (LPI) publication LPI-175, and UL. New building lightning protection systems shall receive a Master C Label from UL after the lightning protection system is evaluated by UL and found acceptable to UL.
2. **Ground Ring:** When a lightning protection system is installed on a new building, provide ground grid around the building. See Section 10.6.4 Grounding.

*Rationale: A ground grid system is required to provide a low ground potential for arcing current flow from a lightning strike.*

3. **Modification of Existing System:** If the outer envelope of an existing building is altered or modified, adapt the lightning protection system and verify the integrity of the protection system. The method for this protection status verification is a UL "Letter of Finding," rather than a review of the entire building. If a whole building review is required, a new Master C Label termed a "Reconditioned Master Label" is required.
4. **Temporary Building or Minor Modifications:** The A/E shall determine the necessity of lightning protection for temporary buildings and for minor additions.
5. **Non-metallic Conduit:** Lightning protection conductors shall be in non-metallic conduit if routed inside the buildings.
6. **Lightning Rod:** Blunt-tipped



# Section 10.7

## Lighting

---

### Contents

- 10.7.0 Introduction
- 10.7.1 Lighting Design Guidelines
- 10.7.2 Interior Lighting
- 10.7.3 Exterior Lighting
- 10.7.4 Lamps
- 10.7.5 Lighting Control
- 10.7.6 Animal Research Facility Lighting and Controls

## 10.7.0 Introduction

The intent of this section is to ensure that lighting systems comply with the NIH goal of providing safe levels of lighting while meeting the sustainability requirements. Often, illumination level is considered the prime lighting design benchmark; however, other visual factors are of great importance especially in environments where difficult visual tasks are performed. These visual factors include:

1. **Uniformity:** Non-uniform illumination level across the work plane increases eye fatigue as the eye needs to continuously adapt to different lighting levels.
2. **Glare:** Direct glare from poorly shielded light fixtures and reflected glare from glossy surfaces reduces visibility.
3. **Shadows:** Shadows degrade visibility and increase eye fatigue.
4. **Surface Brightness:** Unbalanced brightness of work planes, walls, and ceiling degrades visibility and creates an uncomfortable visual environment.
5. **Vertical Surface Illumination:** Inadequate illumination on vertical surfaces such as case work creates an uncomfortable visual environment.

---

## 10.7.1 Lighting Design Guidelines

The lighting designer shall consider each of the visual factors mentioned previously, follow the lighting design guidelines of Illuminating Engineering Society of North America (IESNA), American Society of Heating, Refrigeration, and Air Conditioning Engineers (ASHRAE) 90.1 energy usage requirements, and follow other requirements mentioned in this manual.

## 10.7.2 Interior Lighting

Interior lighting systems shall provide an illumination level adequate for the level of visual task involved, provide visual comfort, and meet sustainability requirements. Recommended ambient lighting levels (with uniformity ratio of 3:1 or lower) for various spaces are given in [Table 10.7.2](#).

**A. General Requirements:** Lighting system design and installation shall comply with the following requirements:

1. **Lighting Calculation:** Use a point-by-point lighting calculation method. In calculating the lighting level, utilize the lamp lumen depreciation associated with the published life of the LED or fluorescent lamp. In modeling laboratories for lighting level calculations, assume shelves as fully loaded, solid surfaces, similar to a wall, providing minimal, if any, contributions from adjacent lighting fixtures. Task lighting shall be considered in lighting calculations.
2. **Recessed Lighting Fixture:** Support recessed lighting fixtures from the building structure with two steel wires (minimum 3.5 mm [0.1 in.]) located at diagonal corners of the fixtures.
3. **Pendant Lighting Fixture:** Provide a minimum of 13 mm (1/2 in.) diameter stems with swivel mounts or aircraft cable hangers with lighting fixture supported by the structural support provided to each wiring box that the fixture is hung from.
4. **Industrial Fluorescent Lighting Fixtures:** Provide a wire guard over the lamps and protective housing end caps.
5. **Task Lighting:** Utilize light-emitting diode (LED) or fluorescent lamps for all task lighting fixtures. Provide protective plastic lens with fluorescent fixtures, and diffuse plastic lens with LED fixtures for under-shelf lighting fixtures.
6. **Layout:** Place light fixtures with direct light distribution directly above and parallel to the front edge of the laboratory bench. Direct/indirect lighting fixtures can be installed in various configurations and orientations.

*Rationale: This is to provide uniform level of lighting at the work surface and prevent shadows.*

**B. Storage, Mechanical Equipment, or Rooms with Exposed/Finished High Ceilings:** Use LED, fluorescent, or high-intensity discharge (HID) lamps to illuminate the rooms, depending on the size of the area and height of the ceiling. When HID fixtures are utilized, use instant restrike ballasts for life-safety egress and emergency illumination.

**Table 10.7.2 Recommended Ambient Lighting Levels (with Uniformity Ratio of 3:1 or Lower) for Various Spaces**

Function/ Space	Lighting Levels in Lux (fc)
Offices	270–375 (25–35) @ 762 mm (30 in.) AFF
Corridors	110–165 (10–15) @ 1,067 mm (42 in.) AFF
Stairwells	55–110 (5–10) @ 1,067 mm (42 in.) AFF
General storage	55–110 (5–10) @ 1,067 mm (42 in.) AFF
Locker and toilets	30–55 (3–5) @ 914 mm (36 in.) AFF
Mechanical/ electrical room	110–215 (10–20) @ 1,067 mm (42 in.) AFF
Laboratories: On benches	750–1075 (70–100) @ 914 mm (36 in.) AFF
General illumination	325–430 (30–40) @ 1,067 mm (42 in.) AFF
Laboratory sup- port areas	325–430 (30–40) @ 914 mm (36 in.) AFF
Laboratory equipment rooms	325–540 (30–50) @ 1,067 mm (42 in.) AFF
Medical pathological waste holding	55–110 (5–10) @ 1,067 mm (42 in.) AFF
Imaging laboratories	550 (50) @ 1,067 mm (42 in.) AFF

*fc = foot-candle; AFF = above finished floor.*

- 1. Telecommunication Equipment Room:** Refer to [Section 11.2](#) for lighting requirements in telecommunication equipment rooms and closets.
- 2. Emergency Lighting:** Provide egress lighting connected to an emergency generator and/or self-contained battery to meet the most stringent requirement among International Building Code, NFPA, and local ordinances. The emergency lighting level shall be a minimum of 10 lux (1 fc) measured at the floor level.

*Rationale: This is to meet the most stringent emergency lighting requirements.*

- 3. Electrical Equipment Rooms:** Provide a minimum of one lighting fixture with self-contained emergency battery pack or emergency battery ballast in all electrical vaults, switchgear rooms, major electrical distribution rooms, and at all locations of transfer switches. Connect 50% of the fixtures in the electrical equipment rooms to a local emergency generator (if installed). Where both normal and emergency circuits are provided and switched, the switching method must turn on the emergency circuit anytime the normal circuit is turned on.

*Rationale: This is to provide personnel safety during the transition period of power transfer and to provide emergency illumination for maintenance in the case of a generator failing to start.*

- 4. Generator Room:** Provide self-contained, battery-powered lighting fixtures connected to emergency power on both sides of the generator(s).

*Rationale: This is to provide personnel safety during the transition period of power transfer and to provide emergency illumination for maintenance in the case of a generator failing to start.*

- 5. Telecommunication Equipment Rooms:** Refer to [Section 11.2](#) for emergency lighting requirements in telecommunication equipment rooms/closets.

6. **Other Rooms:** Provide a minimum of one emergency lighting fixture in the following rooms:
- Facility supervisor's office
  - Mechanical equipment room
  - Receiving area
  - Locker and public multi person toilet rooms

### 10.7.3 Exterior Lighting

Exterior lighting systems shall provide adequate illumination level, avoid hot spots, minimize light trespass, and meet sustainability requirements. Coordinate exterior lighting requirements and exact locations of the exterior lighting fixtures with an NIH technical representative. Lamp types for exterior lighting are as given in [Table 10.7.3](#).

**A. Exterior Exit Lighting:** Provide lighting on emergency power for exterior exit discharge in accordance with NFPA 101. Emergency lighting provided for exit discharge must extend up to the public way or to a minimum of 15.2 m (50 ft.) from the exit discharge.

**B. Security Lighting:** Provide security illumination around the perimeter of NIH property. Coordinate exact requirements with the Division of Physical Security Management as well as other NIH technical representatives.

**C. Street Lighting:** Utilize LED lighting fixtures compatible with the existing NIH campus lighting aesthetics.

*Rationale: This is to set uniform lighting standards throughout the site.*

Street lighting shall comply with following requirements:

- Lighting Level:** Minimum average maintained lighting level of 10 lux (1 fc) on the roadway surface. Uniformity ratio shall be 10:1 or lower.
- Pole height:** Limited to 7.6 m (25 ft.); mounting arm limited to 1.8 m (6 ft.)

**Table 10.7.3 Lamp Types for Exterior Lighting**

Area	Light Source
Food service loading docks	LED or HPS
Architectural lighting	LED or MH
Landscape lighting	LED, MH, or HPS
Loading docks	LED or MH
Parking garages	LED or MH
Site lighting, roadways, sidewalks	LED

LED = Light emitting diode; MH = metal halide;  
HPS = high-pressure sodium

- Pole Spacing:** 27.4 m (90 ft.) to 30.5 m (100 ft.) on two-lane roads. Maximum spacing shall be limited to four times the pole height.
- Lamp Wattage:** Maximum 175 W for MH lamps
- Walkway Lighting:** Utilize fixtures compatible with the existing NIH campus lighting fixtures.

*Rationale: This is to set uniform lighting standards throughout the site.*

**D. Walkways:** Walkway lighting shall comply with following requirements:

- Lighting Level:** Minimum average maintained lighting level of 5 lux (0.5 fc) on the walkway surface. Uniformity ratio shall be 10:1 or lower.
- Lighting Fixture Spacing:** 24.4 m (80 ft.) to 30.5 m (100 ft.); reduce spacing in the elevated security areas or areas that have had high incidences of past accidents. Coordinate these locations with NIH police department.

**E. Architectural Lighting:** Where exterior lighting is used for vertical surface illumination, total architectural lighting connected wattage shall be limited to 1.1 W/m<sup>2</sup> (0.1 W/ft<sup>2</sup>) of exterior wall and maximum lamp wattage to 175 W.

**F. Loading Dock:** Exterior lighting in loading dock areas should utilize full cut-off fixtures with warm color temperatures to reduce the attraction of flying insects. Do not use wall-mounted lighting and do not install lights directly above receiving or personnel

doors. Locate loading dock lighting fixtures (UL listed for damp locations) away from doors and provide a 120 V circuit for “bug zapper” fixtures.

**G. Light Pollution:** Avoid placing lighting poles and other lighting sources near NIH property lines. If this is unavoidable, utilize “house side shields” with good cutoff optics for light trespass control of lighting fixtures.

**H. Lighting Poles:** Exterior lighting poles shall comply with the following requirements:

1. **Pole Base:** Street lighting poles shall have break-away bases. Poles in parking lots or in areas where automobile bumpers may come in contact with the poles shall have 610 mm (2 ft.) concrete bases, and have adjusting leveling nuts. Mounting bolts and adjusting leveling nuts shall have trim cover(s).

*Rationale: This is to protect lighting poles from damage from automobile contact.*

2. **Pole Identification:** Provide aluminum 127 mm × 38 mm (5 in. × 1-1/2 in.) tag riveted to the pole. The tag shall clearly identify the pole number, lighting fixture type, the building where the electrical panel is located, panel name, circuit number and power voltage.
3. **Pole Grounding:** All lighting poles shall be grounded. Provide a 3 m (10 ft.) long, 19 mm (3/4 in.) diameter copper-clad ground rod in the foundation. Ground all metallic components, including metal standard and the equipment ground wire of the power circuit, to the ground rod. Extend an equipment ground wire to the luminaire.

*Rationale: This is to protect lighting poles from lightning and allow over-current protection system to function properly.*

**I. Surge Protection:** Pole mounted LED fixtures shall be provided with integral surge protection.

**J. Other Requirements:** Exterior lighting installation shall comply with the following requirements:

1. **Circuit Breaker:** The protective circuit breakers shall be single pole. The maximum circuit breaker size protecting site lighting circuits shall be 30 A.

*Rationale: This is to preclude a total outage of lighting in an area.*

2. **Wiring:** Site lighting circuits shall use minimum #6 AWG wire in minimum 41 mm (1-1/2 in.) PVC conduit.

*Rationale: This is to allow future addition of lighting poles to an existing circuit.*

3. **In-line Fuses:** Provide in-line fuses located within the pole base or transformer housing.
4. **Splice:** Circuits shall have no underground splices or tee splices. Splices shall only occur in accessible locations in light pole bases.
5. **Existing Lighting Circuit Voltage:** Coordinate existing site lighting circuit voltage information with a NIH technical representative.

## 10.7.4 Lamps

Utilize LED lamps throughout facilities unless approved by DTR. LED lamps provide significant benefits in cost savings as well as environmental impacts. LED lamps and fixtures shall be used in all new construction and renovations unless there is a compelling technical justification for using another lamp type, in which case a variance shall be submitted to DTR. Other lamp types, if approved by DTR, should follow the specifications below.

**Exception:** Incandescent lamps may be used in color-sensitive applications and where electronic noise from lamp drivers may be an issue; HID lamps may be used in high ceiling areas.

*Rationale: This is to restrict use of less energy efficient incandescent lamps.*

**A. LED Lamps:** Lamps shall have color temperature 3,500°K, color rendering index (CRI) 80 (minimum), and average-rated life of minimum 50,000 hours.

**B. Fluorescent Lamps:** General specification requirements of the fluorescent lamps are as follows:

1. T8 lamps rated between 25 W–32 W for nominal length of 1.2 m (4 ft.); 80 CRI (minimum); 3,500K color temperature, and minimum rated life of 65,000 hours at 3 hours per start used with program rapid start ballasts. 32 W lamps shall provide a minimum of 2,800 initial lumens; 28 W lamps shall provide a minimum of 2,450 initial lumens; 25 W lamps shall provide a minimum of 2,250 initial lumens.
2. T8 lamps rated 15 W for nominal length of 610 mm (2 ft.); 80 CRI (minimum); 3,500K color temperature, 1,090 minimum initial lumens, and minimum rated life of 65,000 hours at 3 hours per start used with program rapid start ballasts.
3. T5 lamps, 80 CRI (minimum), 3,500K color temperature; 26 W for nominal length of 1.17 m (3 ft. 10 in.) with minimum 2,470 initial lumens or 13 W for nominal length of 559 mm (1 ft. 10 in.) with minimum 1,140 initial lumens.
4. T5HO lamps, 80 CRI (minimum), 3,500K color temperature; 54 W for nominal length of 1.17 m (3 ft. 10 in.) with minimum 4,450 initial lumens or 21 W for nominal length of 559 mm (1 ft. 10 in.) with minimum 1,630 initial lumens.
5. Compact Fluorescent Lamps: Nominal tube diameter of 13 mm, CRI 82 (minimum), color temperature 3,500°K, and average rated life of 10,000 hours.
6. U-type lamps are not allowed.

**C. Halogen Infrared Lamps:** Lamps shall have 1,150 initial lumens and average-rated life of 3,000 hours.

**D. Metal Halide Lamps:** Lamps shall have color temperature 3,200°K, CRI 65 (minimum) and average rated life of 9,000 to 15,000 depending on lamp wattage.

**E. High-Pressure Sodium Lamps:** Lamps shall have color temperature 1,900°K, CRI 22 (minimum), and

average rated life of 16,000 to 24,000 depending on lamp wattage.

**F. Specialty Lamps:** Lighting fixtures with specialty lamps with less than 3,000 hours lamp life shall not be used.

**G. LED Driver:** General requirements for LED drivers are as follows:

1. **Listing:** Listed with UL; certified by lighting Electronic Testing Laboratories (ETL)
2. **Efficiency:** Higher than 90%
3. **Power Factor:** 0.90 or above
4. **Sound rating:** Class A per UL 935-84
5. **RFI/EMI:** Comply with Federal Communication Commission (FCC) Title 47 CFR Part 18
6. **Total Harmonic Distortion:** Less than 10%
7. **Transient Voltage Protection:** Comply with IEEE C62.41.1 and IEEE C62.41.2
8. **Dimming:** Dimmable driver shall be capable of dimming light output to 10% of full light output without producing visible flicker.
9. **Warranty:** Minimum five years

**H. Fluorescent Lamp Ballast:** General requirements for fluorescent ballasts are as follows:

1. **Type:** Solid state electronic, programmed rapid start or step-dim ballast. Instant start ballasts are acceptable for line voltage control with infrequent switching. Use programmed start ballasts in areas controlled by occupancy sensor or with frequent switching.
2. **Listing:** Listed with UL; certified by lighting ETL; labeled by Certified Ballast Manufacturer Association (CBM)
3. **Thermal Rating:** Class P; ballast temperature shall not exceed 25°C (77°F) over 40°C (104°F) ambient.
4. **Operating Frequency:** 20 KHz or higher
5. **Minimum Ballast Factor:** 0.85



6. **Sound Rating:** Class A per UL 935-84
7. **RFI/EMI:** Comply with FCC regulation Part 18
8. **Total Harmonic Distortion:** Less than 10%
9. **Transient Voltage Protection:** Comply with IEEE C62.41.1 and IEEE C62.41.2
10. **Dimming:** Dimmable electronic ballast shall be capable of dimming light output to 10% of full light output.
11. **Lighting Regulation:**  $\pm 10\%$  lighting output variation with  $\pm 10\%$  nominal input voltage variation
12. **Warranty:** Minimum five years
13. Contain no polychlorinated biphenyl (PCB)

- a. Private offices
- b. Conference rooms
- c. Restrooms
- d. Storage spaces

In addition to occupancy sensor control, provide local switch control for:

- a. Facility supervisor's office emergency lighting fixture
  - b. CCTV monitored area lighting fixtures (local key switch)
  - c. Supplemental emergency lighting unless noted otherwise elsewhere in this manual.
4. **Dimming:** Provide dimming control for the following spaces and for other rooms at the discretion of the NIH technical representative.
    - a. Auditorium
    - b. Conference room
    - c. Cafeteria as part of the day-lighting control

Provide a dimming control panel in lieu of stand alone dimmer boxes when the number of dimming zones exceeds four.

5. **Digital Timer Switch:** Provide a digital timer switch with a user-adjustable flash-before-off feature for the mechanical, telecommunications, and electrical rooms.
6. **Daylight Harvesting:** Provide daylighting control for lighting fixtures located within 4.6 m (15 ft.) of perimeter glazing and skylight wells. Daylight control shall automatically reduce lighting level in response to available daylight by either:
  - a. Combination of daylight sensor and dimming ballast capable of dimming the lights continuously
  - b. Combination of daylight sensor and stepped lighting switch capable of automatically reducing lighting level in steps and turning off lights

## 10.7.5 Lighting Control

**A. Interior Lighting Control:** Lighting control systems shall be both automatic and manual. Lighting control system shall comply with the following requirements:

1. **Automatic Lighting Control Systems:** Provide programmable lighting control systems for all new construction and major renovations when cost-effective. Automatic lighting control systems shall interface with building automation system (BAS) when required by the program.
2. **Lighting Zones:** Lighting circuits must be properly zoned to allow separate switching based on the occupancy types and usage. Lighting zone shall be no larger than 100 m<sup>2</sup> (1,076 ft<sup>2</sup>) or one structural bay.

**Note:** Digitally addressable ballasts may be used to allow easy rezoning of circuits without any changes to circuiting or disruption of occupants.

3. **Motion Sensor and Local Switch:** Utilize dual technology motion sensor for all rooms except as noted elsewhere in this manual. When fully automatic motion sensor control is provided, provide illumination off delay set for fifteen minutes. Motion sensor control must have "manual on," "automatic off" local controls for the following spaces:

7. **Unswitched:** Egress and supplemental emergency lighting for the following areas shall be unswitched:
  - a. Open offices and administrative areas
  - b. Corridors
  - c. Locker and multi-person toilet rooms (one emergency fixture per room)
  - d. Large electrical and mechanical rooms

*Rationale: This is to allow emergency lighting to function as night lighting.*

8. **Tandem Wiring:** Unless noted otherwise, a maximum of two fluorescent luminaires can be tandem wired. A single odd fixture shall be provided with required number of ballasts.

**B. Exterior Lighting Control:** Utilize photocell control in conjunction with programmable lighting control systems (when provided) for all exterior lighting circuits. In addition, comply with the following requirements:

1. **Photocell:** Install the photoelectric cell facing the north sky on the building where the exterior lighting circuit originates. Provide a photocell bypass switch to energize the circuit during daylight for troubleshooting purposes.
2. **Contactors:** Contactors, if used, shall be mechanically held.
3. **Hours of Operation:** Exterior lighting shall illuminate only during hours of darkness.
4. **Motion Sensing:** Provide motion sensing control to reduce lighting level by 80% when area is unoccupied.

## 10.7.6 Animal Research Facility Lighting and Controls

Lighting level and control in areas within animal research facilities (ARFs) depend on the usage of the space and on the species occupying the space. Consideration shall

be given to uniform lighting in the vertical plane to accommodate vertically stacked cages or aquatics tanks in racks. [Table 10.7.6](#) shows the minimum average lighting levels in various areas of an animal care facility.

**A. Animal Research Facility Lighting:** General requirements of ARF lighting are as follows:

1. **Coordination:** Coordinate animal research-related lighting issues such as photo-toxicity in housed animals to adjust lighting levels to facilitate research needs.
2. **Lighting Fixture Type:** Provide UL listed, IP65 rated, factory sealed and gasketed housings that utilize door frames that seal to fixture housing. Recessed or surface mounted fixtures shall be coordinated with ceiling construction, independently supported from structure, with proper field caulking identified such that fixture remains serviceable.

*Rationale: This is to prevent vermin harborage and transmission in/through lighting fixtures.*

3. **Control Coordination:** Fluorescent ballast and LED Driver types must be coordinated with specified controls. Only electronic ballasts shall be utilized, and LED drivers compliant with IEEE guidelines shall be specified to prevent flicker.
4. **Rooms with Hose-Down Capabilities:** IP65 rated lighting fixtures must be installed in or on gypsum board ceilings.

*Rationale: This is to maintain integrity of lighting fixtures in areas subject to pressurized hose direct water and chemical cleaning.*

5. **Occupancy Sensors:** Occupancy sensors in animal research facilities shall have no ultrasonic sound emissions in order to limit disruptions to research animals.

**B. Animal Holding Area Lighting:** Lighting system design and installation in animal holding areas shall comply with the following requirements:

1. **Power Source:** All lighting fixtures (except specific emergency lighting fixtures) are normally connected to normal power. Though not required by the Association for Assessment and Accreditation of Laboratory Animal Care (AAALAC) organization's accreditation, all lighting fixtures may require emergency backup at the discretion of animal program.
2. **Single Lamp Fixture:** Provide an additional single lamp lighting fixture controlled by a local switch for out-of-diurnal-cycle entry at the discretion of veterinary program. This fixture shall have a red (or possibly other color) sleeve or filmed lens for the lamp at the discretion of veterinary program. The actual user shall provide information for sleeve or lens film color.
3. **Large Animal and Non-human Primate Holding Rooms:**
  - a. Light fixtures in non-human primate rooms shall be provide with tool-less entry

*Rationale: Avoids the risk of maintenance tools being accessed by the non-human primates.*

- b. The diurnal "on" cycle shall provide an illumination level of 540 lux (50 fc), while operating one or two lamps per fixture.
4. **Small Animal and Rodent Holding Rooms:**
  - a. Coordinate light fixture placement with ventilated rack connections, rack locations, and automatic watering systems in order to assure service access and mitigate shadows.
  - b. The diurnal "on" cycle shall provide an illumination level of 270 lux (25 fc), while operating one or two lamps per fixture.
  - c. Wherever possible, locate light fixtures to be accessible from service aisles between cages.
5. **Flexibility:** Lighting fixtures and control for the animal holding room that requires flexibility to handle either species shall follow the requirements of the large animal holding room and utilize dimmable fixtures and dimming controls.

**Table 10.7.6 Minimum Average Lighting Levels (with Uniformity Ratio of 3:1 or Lower) of an Animal Care Facility**

Function/Space	Lighting Levels in Lux (fc)
Animal facilities:	270–810 (25–75)
Rodent holding	multilevel @ 914 mm (36 in.) AFF
Non-human primate holding	540–810 (50–75) multilevel @ 914 mm (36 in.) AFF
Aquatic facilities <sup>a</sup> :	540–800 (50–75) @ 1067 mm (42 in.) AFF
At tank	
General illumination	160–270 (15–25) @ 1067 mm (42 in.) AFF
Non-human primate ante rooms	270–375 (25–35) @ 1067 mm (42 in.) AFF
Animal facility surgery rooms	375–1075 (35–100) @ 1067 mm (42 in.) AFF
Animal facility surgery table area (task area only)	2200 (200) @ 914 mm (36 in.) AFF
Procedure, necropsy, and treatment rooms	1075 (100) @ 914 mm (36 in.) AFF
Cage wash areas	430–540 (40–50) @ 1067 mm (42 in.) AFF
Feed and bedding areas, autoclave, and cage wash service areas	160–270 (15–25) @ 914 mm (36 in.) AFF
Receiving/decontamination area	110–215 (10–20) @ 1067 mm (42 in.) AFF
Animal facility corridors	160–270 (15–25) @ 1067 mm (42 in.) AFF
Medical pathologic waste holding	55–110 (5–10) @ 1067 mm (42 in.) AFF
Insectaries: With environmental chambers <sup>c</sup>	430–540 (40–50) @ 1067 mm (42 in.) AFF
Without environmental chambers <sup>b,c</sup>	270–810 (25–75) @ 914 mm (36 in.) AFF

<sup>a</sup> Coordinate lighting level with research program for different aquatic species

<sup>b</sup> Possible dimming to simulate dusk and dawn cycles.

<sup>c</sup> See Appendix O.1 for further Insectary lighting levels.

6. **Fixture Ballast and Operation:** Provide one lighting fixture with self-testing emergency battery ballast (non-audible, visual indication only) for each large animal and non-human primate holding room. If the animal area lighting is provided with an emergency power source, this shall span the allowable time delay for the transfer from normal to emergency power for personnel safety. This ballast shall minimally operate a single lamp (not to exceed two lamps) per single fixture and shall operate under the same diurnal controls as normal power operation, i.e., the ballasts shall illuminate lamp(s) on during the programmed “on” diurnal cycle only, and not illuminate any lamps if a power outage occurs during the programmed “off” cycle. When either emergency power is available, or normal power is restored, the emergency battery ballasts shall revert back to their standby operation. The same shall apply for small animal and rodents, when required for species room flexibility, but shall be determined on a per project basis as it is not typically required.

*Rationale: This is to provide personnel safety in the handling of large animals.*

**C. Animal Holding Area Lighting Control:** Lighting control system in animal holding areas shall comply with the following requirements:

1. **Lighting Control Systems:** Lighting control systems shall be programmable, using either the BAS or a stand-alone system (which may also be used for flushing operation of the animal watering system), depending on functional needs and which control method is most cost-effective. If dimming, monitoring, and reporting of light levels are not required, consider using individual astronomical timers as a cost-saving method for lighting control within small facilities.
2. **User Interface:** Provide a terminal for user control and adjustment of lighting cycles within the animal research supervisor’s office, or at another location within the animal research holding area as directed by the user.
3. **Battery Backup:** The control system shall be provided with necessary integral battery backup.
4. **Monitoring, Reporting and Alarming:** Though not required by AAALAC accreditation, all animal holding rooms may require monitoring, reporting and alarming on lighting cycle function within each room at the discretion of the animal program. Reporting requirements may include proofing of diurnal cycle and illumination levels.
5. **Programmable Diurnal Cycle:** Provide a programmable diurnal lighting cycle, which typically provides 12 hours “on” cycle and 12 hours “off” cycle, allowing adjustment of either cycle duration or providing for multiple cycles in a single day at user discretion.
6. **Dimming Control:** Provide dimming control to simulate dusk and dawn circadian cycles at the discretion of the animal program.
7. **Diurnal “Off” Cycle:** The diurnal “off” cycle shall require all lamps be extinguished.
8. **Caretaker Cycle:** Provide one local override switch outside each holding room door to turn on the lamp(s) associated with the “on” cycle, plus remaining fixture lamps to achieve an 810 lux (75 fc) level within each room during the caretaker cycle.
9. **Lighting Operation:** For both lighting operation scenarios, an override switch shall circumvent the programmable lighting panel controls diurnal cycling for a user adjustable period of between 0–60 minutes, and then have the programmable lighting control revert back to its normal diurnal cycle as previously programmed. A second manual switch operation is not required to go back to the normal diurnal cycle operation. A second manual operation shall not change or increase the timed override until after the override cycle has timed out, but it is acceptable for the second manual override switch operation to directly force the programmable lighting controller to go back to the normal diurnal cycle operation immediately, as long as this is a standard operational feature.

**D. Lighting and Control for Other Areas:** Other room types located within an animal research facility shall be provided with the following functional lighting requirements:

1. **Autoclave and Cage Wash Service Areas:** Provide UL listed fixture rated for damp location, controlled by occupancy sensor. Lighting fixtures provided within capture hoods shall have a minimum IP63 rating
  - a. **Cage Wash Areas (Except for Service Areas):** All lighting fixtures located within dirty side of the cage wash areas shall be UL listed for wet location, with a minimum of one fixture on emergency power per area operated as an unswitched night light, and any others on normal power with single pole switching or occupancy sensor control.
2. **Quarantine Rooms:** Same requirements listed under large animals, non-human primates, small animals, and rodents
3. **Cubicle Holding Rooms:** These rooms are small closet-like rooms accessed by large sliding doors. The rooms have the same diurnal lighting requirements as other holding rooms; caretaker illumination levels can be met by the lights within the cubicle when the large folding doors are opened. Glass doors will typically require red film to mitigate illumination contribution from lights outside cubicle. Caretaker illumination requirements (and control requirements) apply to the common room that is used to access the cubicles.
4. **Non-human Primate Holding Ante-rooms:** All lighting fixtures shall be IP65 rated and controlled by occupancy sensor with at least one emergency fixture normally controlled by the occupancy sensor
5. **ABSL-2 Procedure, Necropsy, and Treatment Rooms:** All lighting fixtures shall be IP65 rated with at least one fixture either provided with an integral switched self-testing/self-diagnostic battery or on emergency power operated as an unswitched night light. Control lights with a local switch or local dimming switch, do not use occupancy sensors.
6. **Animal Surgery Rooms:** All lighting fixtures shall be UL listed with an IP65 rating, with 50% of the fixtures on normal power and the remaining fixtures on emergency power with single pole toggle switches. At least one fixture on both normal and emergency power shall be provided with self-testing emergency battery ballast (non-audible, visual indication only). Task and exam lights shall be on emergency power.
7. **Storage Room:** All lighting fixtures in sterile storage rooms shall be fully sealed and gasketed with a UL listing for wet locations. All storage room lights shall be fed from normal power and controlled by occupancy or vacancy sensor switches.
8. **Locker and Toilet Rooms:** All lighting fixtures shall be UL listed for damp locations, with at least one fixture on emergency power operated as an unswitched night light, and any others on normal power with single pole or occupancy sensor switching control. Any shower lighting fixtures shall be UL wet, on single pole switching control.
9. **Offices and Administration Areas (Not Including Facility Supervisor's Office):** All lighting fixtures shall be UL listed for damp locations, on normal power controlled by occupancy or vacancy sensor switching. Code required emergency egress lighting, in the common egress path of travel, may remain unswitched and operate as a night light.
10. **Facility Supervisor's Office:** All lighting fixtures shall be UL listed for damp locations, with at least one fixture on emergency power provided with a UL 924 listed transfer device to control emergency fixture with normal room lighting that is controlled by a vacancy sensing switch.
11. **Feed and Bedding:** All lighting fixtures shall be UL listed with an IP65 rating, controlled by vacancy sensing switches.
12. **Receiving/Decontamination Area:** All lighting fixtures shall be UL listed with an IP65 rating. Confirm decontamination protocols with facility operations and provide stainless steel housings where necessary. Provide one fixture on

emergency power operated as an unswitched night light, and any others on normal power with single pole or occupancy sensor switching control.

**13. Corridors:** All lighting fixtures shall be UL listed. Within the gowned-in area light fixtures shall have a minimum wet location listing; outside the gowned-in area light fixtures shall have a minimum damp label listing. Lighting fixtures shall be controlled by occupancy sensors or time clock scheduling. Where time clock scheduling is utilized, emergency egress lighting supplied by emergency power shall be operated as un-switched night lights. Where occupancy sensors are utilized, the facility has the discretion to control the emergency egress lighting via UL 924 listed transfer devices or operate as un-switched night lights.

**14. Medical Pathological Waste Holding:** Environmental box with vapor-proof lighting provided by box manufacturer, external pilot light single pole switch control, and control panel (including refrigeration system) shall be on emergency power.

**15. Aquatic Feeding Area:** All lighting fixtures shall be on normal power with single pole or occupancy sensor switching controls. Lighting fixtures located in close proximity to the tanks shall be UL listed for wet locations.

**E. BSL-3 and ABSL-3 Facilities:** Lighting in BSL-3 and ABSL-3 areas shall comply with the requirements of this section and additional requirements as outlined in [Section 10.8.4 Lighting](#).



# Section 10.8

## BSL-3 and ABSL-3 Biocontainment

---

### Contents

10.8.0 Introduction

10.8.1 Electrical Power Systems

10.8.2 General Requirements

10.8.3 Conduit, Conductors, Cables, and Boxes

10.8.4 Lighting

## 10.8.0 Introduction

BSL-3/ABSL-3 facilities shall meet all the requirements of the preceding sections and meet additional requirements as outlined in this section.

### 10.8.1 Electrical Power Systems

**A. Electrical Service:** Electrical service for the NIH Bethesda, Maryland, campus shall follow the requirements outlined in sections [Section 10.2 Electrical Service and Normal Power](#), and [Section 10.3 Emergency Power](#). Buildings other than the NIH Bethesda campus, not including small laboratory facilities or small renovations of existing facilities, shall have a minimum of two dedicated utility services, physically separated in different ductbanks and different manholes. These dedicated services shall be fed by different primary substations or by one double-ended utility substation, which is fed by two dedicated utility service lines. Each required electric service to the facility shall be sized to handle 100% of the design load (i.e., N + 1 redundancy).

*Rationale: This is to increase the reliability of the electrical services.*

Consider the following criteria when designing electrical service.

1. **Customer Owned Service Equipment:** The customer rather than the utility company should own the on-site electrical distribution including medium voltage (MV)/low voltage (LV) transformers.

*Rationale: This provides the owner with greater control over the selection of the equipment and aids maintenance of the equipment.*

2. **Utility Owned Service Equipment:** When customer owned distribution system installation is not possible, coordinate with the local utility company to ensure that they provide an electrical distribution system that meets the facility's requirements.

*Rationale: Electrical demand of the facility may considerably exceed the utility's own engineering and construction standards. As a result, coordination with a utility company is critical in providing reliable electrical service.*

3. **Switchgear at Other Locations:** For non-NIH Bethesda, Maryland, campus BSL-3/ABSL-3 projects with low voltage double ended switchgear, an automatic main-tie-main breaker configuration is acceptable. The switchgear shall be metal-clad compartmentalized type with each breaker capable of being racked out and replaced with the switchgear energized.
4. **Utility Installation:** The preferred method of installation for the electric utility services is underground; overhead lines may be used only within the secured perimeter of the facility.
5. **Location of Distribution Equipment:** Locate distribution equipment, such as MV switches and transformers, in a secured location.
6. **Reliability:** Evaluate and minimize single points of failure for all systems including power supplies, electrical distribution, grounding, equipment, and controls for all projects. Where a single point of failure is present, the A/E shall document the condition and forward the finding for NIH review.

*Rationale: This is to preclude outage due to a single point of failure.*

7. **Separate Feeders:** Downstream electrical distribution from switchgear to critical areas, such as mechanical support rooms with redundant motors in each set, shall comprise pairs of distribution switchboards/panelboards, each fed from a separate side of the switchgear, to supply approximately half of each set of motors. Where possible, provide separate feeders to packaged units with multiple motors, i.e., a separate feeder for each motor.

**B. Standby Power Requirements:** In addition to the loads listed in [Section 10.3 Emergency Power](#), connect the following loads to the standby electrical systems:

1. Heating and cooling units provided for critical support function
2. Receptacles serving selected equipment identified as critical by the program
3. General lighting in laboratories as specified in [Section 10.8.4 Lighting](#).
4. Critical control and containment equipment compressed air systems

As determined per program basis, recommend connecting the following loads to the standby electrical system:

1. Freezers/refrigerators
2. Sterilizers
3. Cage wash equipment for remote locations, where there are no other options available to accommodate an extended outage
4. Other loads as required by the program based on the risk assessment

**C. Uninterruptible Power Supply:** A central UPS system or a number of local UPSs may be required to backup all building wide low voltage systems that are essential for containment operation, safe shutdown of the facility and for critical BSL-3/ABSL-3 specific loads. Perform an economic analysis to select the appropriate UPS system. UPS installation shall comply with following requirements:

1. **UPS Type:** Central UPS shall be of the double-conversion online type; wet cell type batteries are recommended.
2. **UPS Loads:** Recommend connecting the following systems to the UPS:
  - a. Building automation system (BAS)
  - b. Select light fixtures in lieu of emergency battery packs
  - c. Communications and PA systems
  - d. Fire alarm systems
  - e. Laboratory equipment monitoring systems
  - f. Mechanical controls

- g. Security, CCTV, and access control systems
- h. Mechanical equipment as required by the program

**D. Emergency Generator:** Provide a local generator dedicated to the facility to provide emergency/standby power; however, a remote generator farm (with redundant feeders) may also be acceptable.

Consider providing 100% generator backup for facilities where the loads mandated to be connected to a generator comprise the majority of the load of the facility. Consider loss of redundancy in emergency operation of the facilities with 100% generator backup and update operational procedure during emergency operation.

**E. Load Bank:** Provide a load bank (including a connection point suitable for use for a portable generator) for periodic testing of the generator.

---

## 10.8.2 General Requirements

**A. Electrical Installation in Containment Areas:** Avoid installing electrical equipment which requires service within a containment area. Electrical systems and equipment not serving the BSL-3/ABSL-3 area shall not be located within the containment area.

**B. Containment Barrier Penetrations:** Penetrations through the containment barriers shall comply with the following requirements:

1. Penetrations through the containment barriers shall be gas-tight, non-porous, smooth and cleanable; and readily visible for routine inspection, cleaning, and maintenance. Penetrating components shall be sufficiently rigid in construction and adequately braced to structure to maintain the long-term integrity of the penetration. The result shall be free of sharp edges or similar hazards.
2. All penetrations shall be durable, sealed, and tested to meet the room tightness criteria for BSL-3/ABSL-3 laboratories.

**C. Submission and Mock-up:** Penetrations into the containment barrier (including mounting of electrical boxes) shall be detailed in the construction documents

and shall require mock-ups to be constructed and tested prior to installation. Penetration details for equipment shall be coordinated with the equipment manufacturer.

**D. Sealing Requirements:** Provide silicon-based caulk in all areas. See [Appendix L: Sealant Table](#).

### 10.8.3 Conduit, Conductors, Cables, and Boxes

**A. Conduits for All Systems:** Conduit applications in BSL-3/ABSL-3 facilities are as follows:

1. **Conduit Type:** Use Rigid Galvanized Steel (RGS) conduit with threaded fittings in all BSL-3 areas.
2. **Seal-off:** Provide seal-off fittings when conduits exit defined BSL-3/ABSL-3 perimeter.
3. **SMR:** Use of surface metal raceway systems (SMRs) is not allowed in BSL-3/ABSL-3 areas.

*Rationale: This is to provide a gas-tight electrical distribution system to facilitate decontamination, and prevent vermin harboring and passage through the electrical raceway system. Surface metal raceway is not available with manufactured approved gasketing to eliminate vermin harborage and transmission.*

**B. Power Wiring:** Insulation shall be compatible with sealing compound (sealing compound non-deleterious to insulation), using THW, THWN, THHN/THWN, or XHHW.

*Rationale: This is to protect insulation of the electrical wire from damage from sealing compound.*

**C. Other System Wiring:** Voice/data, fire alarm, control, and security system wiring shall follow the same sealing requirements as that of the power wiring. Cable types shall be determined by NIH Information Technology and manufacturer's recommendations for

voice/data wiring and by respective system manufacturers for other systems. The A/E shall coordinate exact requirements for security wiring with the Division of Physical Security Management (DPSM) for projects within NIH, Bethesda campus.

**D. Boxes for All Systems:** General requirements of device boxes are as follows:

1. **Type and Depth:** All boxes shall be double gang type; the box depth shall be at least the next size larger than the minimum size required per code.

*Rationale: This is to provide added device box volume for wiring and required sealing within device boxes.*

2. **Cast Boxes:** Provide cast boxes with external mounting provisions, external hub, and gasketed device cover plates.
3. **Sealing:** Provide a 25 mm (1 in.) barrier of silicone caulk around the wire within a device box hub. Provide a continuous bead of caulk between the device box and the adjacent surface. Provide a continuous bead of caulk around the device cover plate and the adjacent surface.

*Rationale: This is to provide for a gas-tight electrical installation for decontamination, and to prevent vermin harboring and passage through the electrical raceway system.*

### 10.8.4 Lighting

**A. Containment:** The lighting systems shall be designed to ensure that biohazards are contained within the laboratory area.

**B. Lighting Fixtures:** Lighting fixture installation shall comply with the following requirements:

1. **Listing:** Fixtures shall be UL listed with a minimum IP65 rating.

**Rationale:** *This is required for strict moisture and vermin control required within the space.*

2. **Decontamination:** Lighting fixtures shall allow full decontamination with ease of effort, and permit easy re-lamping and access to ballasts.
3. **Type:** Lighting fixtures shall be provided with stainless steel housings, glass or heavy duty acrylic prismatic lens, and stainless steel door with tool-less fasteners or captive, flush, stainless steel screws.

**Rationale:** *This is to allow the cleaning of the lighting fixture and decontamination by gaseous means.*

4. **Mounting:** Use surface mounted, fully sealed, enclosed, and gasketed fluorescent or LED fixtures. Seal surface mounted fixtures with a continuous bead of sealant around its perimeter to seal housing to ceiling. Lighting fixture must have a sealed conduit entrance to housing. Lighting fixtures may be pendant mounted only in an open ceiling. Pendant-mounted lighting fixtures shall be fully sealed and gasketed with same features as those of surface mounted fixtures including both a sealed conduit entrance to housing and a sealed conduit entrance at ceiling canopy.

**Rationale:** *This is required for strict moisture and vermin control required within the space.*

5. **Layout:** Install fixtures in continuous rows and aligned with edge of laboratory bench in laboratories and laboratory support areas. Install lighting fixtures in a symmetrical pattern.

Fixtures mounted in continuous rows shall have flush ends that can be field caulked; fixtures not mounted in continuous rows should have a minimum of 152 mm (6 in.) between fixtures to allow for disinfection.

6. **Imaging Laboratory:** In specific imaging modalities, such as MRI, incandescent or LED fixtures and conduit shall be made of non-ferrous materials. Utilize EMI filters and DC dimming methods that are compatible with imaging equipment. All special requirements shall be coordinated with the manufacturer of equipment in each modality.

**C. Emergency Lighting:** Emergency lighting installation shall comply with the following requirements:

1. **Emergency Power Source:** Connect at least 50% of light fixtures in the laboratories to the emergency power source.
2. **Emergency Battery Ballast:** Provide at least one lighting fixture per room in laboratory areas with self-testing emergency battery ballast. Connect the lighting fixtures with emergency ballasts to unswitched local emergency generator circuits.
3. **ABSL-3 Areas:** In addition to the above requirements, battery ballasts shall not be self-testing type.

**D. Lighting Control:** Laboratories shall utilize line voltage toggle switches. Occupancy sensors may be used in laboratory support and other areas. In addition, specialized lighting controls (such as dimming systems and DC lighting controls) shall be provided per specific program requirements. If occupancy sensors are used, specify infrared sensors with sealed enclosures.

# Chapter 11

---

## Telecommunication Systems Design



# Section 11.1

## Telecommunication Systems Design

---

### Contents

11.1.0 Introduction

11.1.1 Telecommunications System Growth

11.1.2 Renovation and Rehabilitation

11.1.2.1 Recommendations

11.1.3 Codes and Standards

11.1.4 Design Documentation

## 11.1.0 Introduction

The objectives of the telecommunication systems design guidelines are to establish uniformity of design, achieve the best overall cost-effective installation, and construct a telecommunications system that is compatible with other building systems. The following design requirements shall apply to all telecommunication systems design.

---

### 11.1.1 Telecommunications System Growth

Telecommunication systems design shall include provisions for future system growth as determined by the NIH on a project-by-project basis.

Due to the ever changing nature of the Information Technology (IT) systems, Center for Information Technology (CIT) compiles a living standard volume that reflects current changes in NIH IT Infrastructure. This CIT standard document should always be requested at the beginning of all new projects so the architect can reflect those changes in the IT infrastructure design.

---

### 11.1.2 Renovation and Rehabilitation

The renovation and rehabilitation of existing NIH facilities does not always allow for the adoption of the latest industry standards. Sometimes, the existing telecommunication systems are antiquated or inadequate for the current need; the newly planned function may be incompatible with the original building design criteria.

### 11.1.2.1 Recommendations

The A/E shall evaluate early in the design stage the feasibility of implementation of the latest standards. The A/E shall document such findings and submit the findings and recommendations to the project officer (PO).

---

### 11.1.3 Codes and Standards

The A/E shall comply, as a minimum, with the latest edition of the applicable codes and standards as listed in [Chapter 1: Administration](#). In addition, the A/E shall comply with other safety guidelines received from the PO and other relevant guidelines as required by the program.

---

### 11.1.4 Design Documentation

The A/E shall submit drawings, specifications, cost estimates, and calculations at different stages of a project. Refer to [Appendix E: A/E Submission Requirements](#) for documentation requirements at the completion of each stage.

# Section 11.2

## Telecommunications/Local Area Network Closet/Room Construction Criteria

---

### Contents

#### 11.2.0 Introduction

#### 11.2.1 Telecommunications Closet

##### 11.2.1.1 Closet Size and Location

##### 11.2.1.2 Wall Requirements

##### 11.2.1.3 Door Requirements

##### 11.2.1.4 Ceiling Requirements

##### 11.2.1.5 Floor Requirements

##### 11.2.1.6 Environmental Requirements

##### 11.2.1.7 Lighting Requirements

##### 11.2.1.8 Electrical Requirements

##### 11.2.1.9 Network Equipment Electrical Requirements

##### 11.2.1.10 Fire Protection Requirements

#### 11.2.2 Additional Requirements

## 11.2.0 Introduction

This section describes minimum requirements established by the Center for Information Technology (CIT), Division of Network Systems and Telecommunications (DNST).

### 11.2.1 Telecommunications Closet

**A. Definition:** The telecommunications (TEL)/local area network (LAN) closet (referred to as “the closet” in this chapter) houses:

1. The transition point between the information technology backbone and the horizontal pathways
2. The horizontal distribution center for the TEL/LAN cabling (it is where the cable tray and feeder conduits terminate)
3. The LAN patch panels, TEL cross-connect fields, and TEL and LAN electronic equipment
4. The telecommunications and optical fiber cable riser and terminations
5. Associated local uninterruptible power supply (UPS) systems

**B. Quantity:** There shall be a minimum of one centrally located closet per floor. Closet(s) shall be strategically located so the farthest work area outlet (WAO) does not exceed a 76 m (250 ft.) telecommunications cable run, which is measured along the actual cable tray route and not as a straight line from the telecommunications closet to the farthest WAO. Reduce the maximum cable run to 70 m (230 ft.) if furniture is to be cabled. Additional closets shall be provided as required to maintain the cable run distance requirements noted.

**C. Location and Usage:** Dedicated closets shall be provided in all areas to prevent the use of electrical closets for telecommunication equipment.

This space shall not be used for any occupant-related servers and systems. TEL/LAN closet shall not be shared with building or custodial services.

#### 11.2.1.1 Closet Size and Location

**A. Size:** The closet size provided shall be 14 m<sup>2</sup> (150 ft<sup>2</sup>) minimum per 929 m<sup>2</sup> (10,000 ft<sup>2</sup>) of occupied space, and with minimum dimensions 3 m × 4.6 m (10 ft. × 15 ft.).

**B. Obstruction:** There shall be no obstructions in the room, including in the ceiling area/plenum.

**C. Stacking:** The closets shall be stacked in multistory buildings. If stacking closets is not possible, locating closets under rooms with wet plumbing is not recommended.

**D. Minimum Separation Distances from Electromagnetic Sources Exceeding 5 kVA:**

1. 610 mm (2 ft.) separation between unshielded power lines or electrical equipment in proximity to open or non-metal pathways
2. 305 mm (1 ft.) separation between unshielded power lines or electrical equipment in proximity to a grounded metal conduit pathway
3. 152 mm (6 in.) separation between power lines enclosed in a grounded metal conduit (or equivalent shielding) in proximity to a ground metal pathway
4. 1.2 m (4 ft.) separation between electrical motors and transformers

#### 11.2.1.2 Wall Requirements

**A. Fire Rating:** Walls shall extend slab to slab, with a minimum one hour fire rated wall or as required by local code or authority having jurisdiction (AHJ).

**B. Fire Rated Plywood:** Closet walls designated by the CIT shall be lined with rigidly installed, wall-to-wall 19 mm (3/4 in.) A-C fire retardant plywood, 2.4 m (8 ft.) tall. The bottom of the plywood shall be 152 mm (6 in.) above the finished floor.

**C. Painting:** All walls and plywood shall be covered with two coats of fire retardant white paint and per local code. White paint shall be Federal Spec. Color 27780, with legible fire rating symbol exposed on each sheet of plywood.

### 11.2.1.3 Door Requirements

**A. Fire Rating:** A single door, 914 mm (3 ft.) wide and 2.1 m (7 ft.) tall, is required and shall be fire rated the same as the walls.

**B. Door Swing:** The door is to swing out from the closet.

**C. Door Locks and Keys:**

1. Standard locks of the Mortise 1000 series shall be installed.
2. A latch plate guard shall be installed to prevent pry bar entry on double doors or single doors that swing out from closet. Five permanent door keys supplied to CIT are required.
3. Electronic door locks must stay locked during power outages, but still allow egress from the inside of the closet.

**D. Card Access:** Card access shall be provided and programmed for CIT access only.

**E. Dust Barrier:** Dust-door strips shall be used on all TEL/LAN closet doors.

### 11.2.1.4 Ceiling Requirements

**A. Lay-in Ceiling:** Lay-in ceiling is not permitted in the TEL/LAN closet.

**B. Painting:** The ceiling must be painted white with Federal Spec. Color 27780.

### 11.2.1.5 Floor Requirements

**A. Loading:** The floor shall have a minimum load rating of 7.2 kPa (150 psf).

**B. Floor Tile:** The floor shall be off-white vinyl composition antistatic covering tile.

**C. Floor Penetrations:** All floor penetrations shall extend 102 mm (4 in.) above and below the finished surface.

### 11.2.1.6 Environmental Requirements

**A. Continuous Operation:** Heating, ventilating, and air conditioning (HVAC) systems shall operate twenty-four hours per day, 365 days per year. If the building system cannot ensure continuous operation, there shall be provided a stand-alone HVAC unit.

**B. Emergency Power:** If an emergency power source is available, connect the HVAC system that serves the TEL/LAN closet to the emergency power source.

**C. Design Temperature:** The temperature for the closet shall be maintained between 17.78°C (64°F) and 23.33°C (74°F).

**D. Design Stabilizing Humidity Levels in Closets:** 30–55% relative humidity.

**E. Design Heat Dissipation Load:** Heat dissipation shall be a minimum of 15,000 British thermal units (BTUs) per hour. This will accommodate four racks.

**F. Pressure Difference:** Maintain positive pressure relative to adjacent spaces with a minimum of one air change per hour.

**G. Location:** HVAC unit shall not be placed inside the TEL/LAN closet.

**H. Thermostat:** This temperature shall be adjustable from inside the TEL/LAN closet. An independent adjustable thermostat shall be installed inside the closet. Provide a manual and password for the thermostat.

### 11.2.1.7 Lighting Requirements

**A. Lighting Level:** The closet shall have uniform lighting that provides a minimum of 540 lux (50 fc) when measured 914 mm (3 ft.) above the finished floor.

**B. Lighting Fixture:** 1.2 m (4 ft.), LED or fluorescent strip light fixture protective lens shall be provided.

**C. Lighting Fixture Layout:** Locate light fixtures a minimum of 2.6 m (8 ft. 6 in.) above the finished floor. Coordinate fixture layout with the equipment rack location and the overhead cable trays to ensure the fixtures are not obstructed.

**D. Emergency Power:** All lighting fixtures in the TEL/LAN closet shall be on the emergency lighting circuit or be provided with a ninety minute battery backup.

### 11.2.1.8 Electrical Requirements

**A. General:** Contact CIT for exact power requirements for wall fields and equipment racks. All receptacle specifications shall be provided by CIT.

**B. Panelboard:** Provide one panelboard with 42 poles, 3 phase, 4 wire, 225A lug with a 100A main circuit breaker in each CIT closet (unless otherwise directed by CIT or AHJ Standards and Rules).

**C. Emergency Power:** All electrical power circuits in closet shall be connected to the building emergency circuit (unless otherwise directed by CIT).

**D. Grounding:**

1. Provide an insulated grounding bus bar in each TEL/LAN closet. The telecommunications grounding bus bar shall be connected to the main building ground.
2. Cable contractor shall provide grounding to all racks inside the TEL/LAN closet to the insulated grounding bus bar in that closet.
3. All grounding and bonding shall be performed according to the grounding and bonding drawings.
4. All TEL/LAN equipment shall be grounded to the bus bar in the same closet.

**E. Electrical Outlet:**

1. Provide a 120V, 20A 3 wire utility NEMA 5-20 outlet on each wall in each closet. This will be placed at 457 mm (1 ft. 6 in.) above the finished floor. See CIT TEL/LAN closet sections for quantity and locations.
2. On the telephone equipment wall-field, there shall be one 120V, 20A 3 wire emergency circuit Quad NEMA 5-20 outlet placed at 2.3 m (7 ft. 6 in.) above the finished floor for telephone equipment. See wall-field drawing for locations.

**F. Labeling:** Each circuit ID shall be legibly labeled within the electrical panel. Each circuit ID shall be labeled on its own outlet cover plate. The label shall be made with a computer generated type label.

### 11.2.1.9 Network Equipment Electrical Requirements

**A. General:** All installations must follow AHJ standards and rules. The A/E shall contact the CIT Project Manager (PM) lead to verify the type of outlets required. These outlets are determined by manufacturer, equipment size, UPS size, and area to be served. CIT has final approval for possible upgrade of power provided at the racks.

**B. Electrical Outlet:** There shall be a minimum of three outlets per rack unless otherwise directed by CIT.

1. NEMA 5-20 120V (top outlet)
2. NEMA L5-30 120V (middle outlet)
3. NEMA L6-30 220V (bottom outlet)

**C. Outlet Location:** On the rack, the bottom of the lowest outlet shall be placed at 457 mm (1 ft. 6 in.) above the finished floor. There shall be a clear spacing of 152 mm (6 in.) between each outlet box.

**D. Boxes:** 102 mm x 102 mm (4 in. x 4 in.) electrical outlet boxes shall be used on all racks.

**E. Power Feed:**

1. Power feeding the rack shall originate from the TEL/LAN closet panel.
2. If power is fed from the bottom of the racks, the conduits shall not have on-site 90° bends. Only “T” and “L” conduit bends will be accepted because rack space may be lost by utilizing on-site bends. Conduit placement shall not block rack mounting holes.
3. If power is fed from the top of the racks, it shall not interfere with cable tray installation, horizontal cable management, or any other equipment or installations. Conduit placement shall not block rack mounting holes.

### 11.2.1.10 Fire Protection Requirements

**A. General:** Fire protection shall be provided for the TEL/LAN closet(s) as required by applicable codes.



**B. Sprinkler Head:** If sprinkler heads are required, sprinklers shall have guards and must not be installed directly over any racks or equipment, wherever possible.

**C. Fire Alarm Notification:** An audio/visual building fire alarm shall be installed in the TEL/LAN closet. The audio/visual combination device shall match the existing fire detection system. Comply with requirements of Chapter 9.

**D. Fire Extinguisher:** Fire extinguishers shall meet NFPA 10 in accordance with Chapter 9.

**E. Barrier Penetrations:**

1. All CIT wall, floor, and ceiling barrier openings and penetrations require approved fire protection.
2. Fire protection methods, materials, and considerations for establishing the integrity of fire rated architectural structures and assemblies (e.g., walls, floors, and ceilings) required by building codes shall be observed when cables and pathways, such as conduits, penetrate these barriers. Pillow-type barriers shall not be used for pipe penetrations. A copy of the UL document will be provided to the NIH prior to installation.
3. All fire stopping inside and outside of TEL/LAN closets shall be provided by the general contractor or predetermined responsible party.
4. Each installed fire stopping for CIT penetrations shall be photographed and supplied to the CIT cable branch project manager.
5. CIT will supply all fire stopping labels to contractors installing fire stopping for all CIT openings and penetrations. Each label shall list all information shown in Table 11.2.1.10 and be placed on both sides of the barrier penetration. The label shall reflect the information available at the time of installation.
6. Cable trays must not penetrate through walls; use fire-stopping sleeves.

**Table 11.2.1.10 Information Required for Fire Prevention Labels**

Date of installation	Fire rating
NIH/CIT project contract number	Product manufacturer
Size of opening	UL listed product material
CIT help desk number	On-site installer

*NIH = National Institutes of Health; CIT = Center for Information Technology*

## 11.2.2 Additional Requirements

**A. General:** See CIT TEL/LAN closet drawings for verification and additional installation information.

**B. Other Utilities Installation:** Utilities equipment not related to the support of the TEL/LAN closet such as piping, ductwork, auxiliary cooling unit, distribution of power, etc. shall not be located in or pass through the closet.

**C. Drip Pans:** Drip pans are required if closets are located under rooms with wet plumbing.

**D. Cable Tray:**

1. A 457 mm wide x 102 mm deep (1 ft. 6 in. wide x 4 in. deep) minimum cable tray shall be installed around the main hallway perimeter of the building and extend to the closet. All joints in the tray shall use factory made joint couplings.
2. A 457 mm wide x 102 mm deep (1 ft. 6 in. wide x 4 in. deep) minimum cable tray shall be installed along entire length of the closet and to racks to distribute cable in the closet. There shall be a 305 mm x 25 mm (1 ft. x 1 in.) ladder rack installed vertically slab to slab behind the metallic sleeves for vertical riser cable support.
3. A #6 AWG copper-bonding jumper shall be installed between each section of the tray and be terminated with #2 crimp type connector.

**E. Connection to Main Closet:** A minimum of four 102 mm (4 in.) conduits shall connect the closet with the main closet(s). Each 102 mm (4 in.) conduit bank shall have one conduit installed with three 38 mm (1-1/2 in.) inner ducts with pull lines.

**F. Connection to Antenna:** Provide two 102 mm (4 in.) conduits through the roof to the nearest TELE/LAN closet for antenna connection.

**G. Interconnections:** Two 102 mm (4 in.) diameter horizontal conduits shall connect between multiple CIT closets on the same floor. Exact quantity, size and pathway shall be determined with CIT depending on the TEL/LAN closet(s) layout. Each conduit bank shall have one conduit installed with three 38 mm (1-1/2 in.) innerducts with pull lines.

# Section 11.3

## Cable Management

---

### Contents

#### 11.3.0 Introduction

#### 11.3.1 Inter-Building Riser

##### 11.3.1.1 Sleeves or Slots

##### 11.3.1.2 Open Shaft

##### 11.3.1.3 Conduits and Pull Boxes for Ties and Riser

#### 11.3.2 Cable Management System

##### 11.3.2.1 Cable Management System Installation

#### 11.3.3 Horizontal Pathways

##### 11.3.4 Barrier Penetrations

## 11.3.0 Introduction

This section describes cable management systems for telecommunication and other low voltage systems.

### 11.3.1 Inter-Building Riser

#### 11.3.1.1 Sleeves or Slots

**A. Cable Sleeve or Slot Installation:** Cable sleeves or slots shall be positioned adjacent to the wall on which the backbone cables are to be supported. Sleeves or slots shall not obstruct wall terminating space, that is, they shall not be directly above or below the wall space that is to be used for termination fields. Slots shall be constructed with a minimum 25 mm (1 in.) high curb. Sleeves shall extend a minimum of 102 mm (4 in.) above the finished floor.

**B. Coordination:** The A/E shall provide sleeve and slot quantity and configuration per ANSI/TIA-569 Standard, with the team's structural engineer's review and approval of the quantity, location, and configuration of sleeves.

#### 11.3.1.2 Open Shaft

**A. When Required:** Open cable shafts are used when available and where large quantities of cables are required on a floor that is distant from the main equipment room (e.g., the main equipment room is in the basement and a large quantity of circuits are required on the top floor).

#### 11.3.1.3 Conduits and Pull Boxes for Ties and Riser

**A. Conduit Size:** Conduits placed to support risers and closet tie cables shall be of a minimum of 102 mm (4 in.) electrical metallic tubing (EMT).

**B. Pull Boxes:** There shall be a pull box every 30.5 m (100 ft.), sized so that exit and reentry of cable is supported in case the pull requires re-rigging and to support the bend radius of the cables to be placed.

## 11.3.2 Cable Management System

**A. Type:** A cable management system or cable tray shall be comprised of a continuous rigid welded steel wire mesh cable management system with continuous safety edge wire welded to the top of the tray, and wire mesh welded at all intersections. The open mesh permits easy access to the tray and provides continuous ventilation of cables installed in the tray.

**B. Construction:** The cable tray system shall be of a "basket" type construction; a rigid-type cable tray shall not be accepted.

**C. Non-ferrous or Aluminum Cable Tray:** A non-ferrous or aluminum cable tray shall be used in areas subject to high magnetic fields. Possible restrictions may be in place for an aluminum cable tray due to radiofrequency (RF) interference.

**D. Cable Tray Sizing:** Cable management systems sizing shall be no smaller than 457 mm wide x 102 mm deep (18 in. wide x 4 in. deep). The final determination of depth, width, and layout design shall be coordinated with and approved by the Center for Information Technology (CIT).

**E. Grounding:** A continuous ground system shall be accomplished by the use of approved splices and bonding jumpers.

**F. Finishes:** Electroplated zinc galvanizing (standard stock finish) is suitable for most indoor applications and shall be used outdoors in mild environments only. Hot-dip galvanizing is most suitable for outdoor applications or environments where increased corrosion resistance is desired.

### 11.3.2.1 Cable Management System Installation

**A. General:** The cable management system shall be installed using hardware, splice connectors, support components, and accessories furnished by the manufacturer. All turns and "waterfalls" shall be of manufactured products.

**B. Cutting:** All cutting of the cable management system shall be performed using manufacturer cutting techniques and cutting tools.

**C. Access:**

1. All cable trays shall be accessible with a minimum of a 152 mm (6 in.) clearance on all sides.

**D. Maximum Span Distance:** There shall not be a span of a distance of 1.8 m (6 ft.) or more that does not allow access to the cable tray.

**E. Code Compliance:** The cable tray shall be installed to meet National Electrical Code (NEC) Article 392 and other applicable codes.

**F. Usage:** Systems other than telecommunications/local area network (TEL/LAN) shall not utilize the LAN cable tray unless approved by CIT. When approved, other systems may utilize the cable tray system, provided barriers are installed between the systems or J-hooks are provided attached to the cable trays.

---

### 11.3.3 Horizontal Pathways

**A. Work Area Locations:**

1. Work area locations of a CAT5E/CAT6 voice and CAT6 data solution shall be sized as a 25 mm (1 in.) EMT conduit to each location.
2. Work area locations of a CAT5E voice and CAT7 data solution shall be sized as a 32 mm (1-1/4 in.) EMT conduit to each location.
3. Horizontal pathways shall be bonded to the cable management system (cable tray) with a #6 AWG ground.

4. Each conduit shall have a factory produced ground bushing on the end to facilitate this grounding.
5. All work area outlets shall have its own conduit pathway; “daisy chaining” of any horizontal pathway is not permitted.

**B. Bends:** Conduits shall not have any more than two 90° bends and shall terminate at the closest point. A ground conductor conduit may have up to four 90° bends.

**C. Pull Boxes:** If pull boxes are required, they are to be placed every 30.5 m (100 ft.) for placement of tie cables and or larger bundles of unshielded twisted pair (UTP) cable.

#### 11.3.4 Barrier Penetrations

**A. Penetrations:** Penetrations shall be caulked and sealed as required. See [Appendix L: Sealant Table](#). The minimum required quantity shall be applied per code, in addition to specific project needs and/or structural limitations. Provide fire proofing and vermin proofing as required.

**B. Fire Stopping:** All fire stopping systems shall meet the UL requirements for the specific type of wall construction and penetration.

# Section 11.4

## Site Utility

---

### Contents

**11.4.0 Introduction**

**11.4.1 Duct Bank Construction**

**11.4.2 Underground Concrete Utility Structures**

**11.4.2.1 Manholes**

**11.4.2.2 Accessories**

**11.4.2.3 Construction Materials**

**11.4.3 Outside Plant (OSP) Pull Boxes/Handholes**



## 11.4.0 Introduction

This section describes site utility requirements for telecommunication and other low voltage systems.

### 11.4.1 Duct Bank Construction

**A. Configuration:** All duct bank placed shall be a minimum of a 4-way duct bank system in a 2 × 2 configuration. Depending on the size of the building, a larger duct bank may be required. The final sizing of the duct bank system shall be determined by the Center for Information Technology (CIT).

**B. Pipe Material:** Duct banks shall be sized at 102 mm (4 in.) rigid plastic conduit; NEMA TC 2, Schedule 40 polyvinyl chloride (PVC), rated for use with 90°C conductors under all installation conditions.

**C. Encasement:** Duct banks shall be encased with a minimum of 25 mm (1 in.) of concrete over the top ducts. Concrete shall be 20.7 MPa (3,000 psi) minimum, twenty-eight day compressive strength with 10 mm (2/5 in.) maximum aggregate.

**D. Cover:** Duct banks shall be placed at a minimum depth of 914 mm (3 ft.) to the top duct.

**E. Spacer:** Provide with rigid PVC spacers selected to maintain minimum duct spacing and concrete cover depths indicated, while supporting ducts during concreting.

**F. Bends:** Factory produced “communications” sweeps shall be used in lieu of 90° bends. There shall be no more than two 90° bends in any duct bank run.

### 11.4.2 Underground Concrete Utility Structures

#### 11.4.2.1 Manholes

**A. General:** Manholes shall be precast units comprised of interlocking, mating sections, complete with accessory items, hardware, and features as indicated.

Manholes shall include concrete knockout panels for conduit entrance and sleeve for ground rod. The structure shall be designed per ASTM C 858. The structural design loading shall be per ASTM C 857, Class A-16 and the fabrication shall be per ASTM C 858.

**B. Cover:** The cover shall be recessed to accept finish materials in landscaped and paved areas. Joint sealant shall be a continuous extrusion of asphaltic-butyl material with adhesion, cohesion, flexibility, and durability properties necessary to withstand maximum hydrostatic pressures at the installation location with the ground water level at grade.

**C. Quality Control:** Project specifications shall include quality control for inspecting structures per ASTM C 1037.

#### 11.4.2.2 Accessories

**A. Accessories indicated shall conform to the following:**

1. **Frames and Covers:** Cast iron with cast-in legend, “COMMUNICATIONS”; machine cover- to frame-bearing surfaces
2. **Sump Frame and Grate:** Comply with FS RR-F-621, type VII for frame and type I for cover
3. **Pulling Eyes in Walls:** Eyebolt with reinforcing-bar fastening insert, 51 mm (2 in.) diameter eye, and 25 mm × 102 mm (1 in. × 4 in.) bolt; working load embedded in 152 mm (6 in.), 27.6 MPa (4,000 psi) concrete, and 58 kN (13,000 pound force [lbf]) minimum tension
4. **Pulling and Lifting Irons in Floor:** 25 mm (1 in.) diameter, hot-dip galvanized, bent steel rod, stress relieved after forming, and fastened to reinforced rod; exposed triangular opening. Ultimate yield strength shall be 180 kN (40,000 lbf) shear and 270 kN (60,000 lbf) tension.
5. **Bolting Inserts for Cable Stanchions:** Flared, threaded inserts of non-corrosive, chemical-resistant, non-conductive thermoplastic material; 13 mm inner diameter × 70 mm deep (1/2 in. inner diameter × 2-3/4 in. deep), flared to 32 mm (1-1/4 in.) minimum at base. Tested ultimate pullout strength shall be 53 kN (12,000 lbf) minimum.

6. **Expansion Anchors for Installation after Concrete is Cast:** Zinc-plated, carbon-steel-wedge type with stainless steel expander clip 13 mm (1/2 in.) bolt size, 24 kN (5,300 lbf) rated pullout strength, and minimum 30 kN (6,800 lbf) rated shear strength
7. **Cable Stanchions:** Hot-rolled, hot-dip galvanized, T-section steel, 57 mm (2-1/4 in.) size, punched with 14 holes on 38 mm (1-1/2 in.) centers for cable-arm attachment
8. **Cable Arms:** 5 mm (1/5 in.) thick, hot-rolled, hot-dip galvanized, steel sheet pressed to channel shape; 305 mm wide x 356 mm long (1 ft. wide x 1 ft. 2 in. long) and arranged for secure mounting in horizontal position at any position on cable stanchions
9. **Cable-Support Insulators:** High-glaze, wet-process porcelain arranged for mounting on cable arms
10. **Ground Rods:** Solid-copper-clad steel, 19 mm diameter x 3 m length (3/4 in. diameter x 10 ft. length)
11. **Ground Wire:** Stranded bare copper, #6 American Wire gauge (AWG) minimum
12. **Duct Sealing Compound:** Non-hardening; safe for human skin contact; not deleterious to cable insulation; workable at temperatures as low as 1°C (34°F); and capable of withstanding temperature of 149°C (300°F) without slump and of adhering to clean surfaces of plastic ducts, metallic conduits, conduit coatings, concrete, masonry, lead, cable sheaths, cable jackets, insulation materials, and common metals.

### 11.4.2.3 Construction Materials

**A. Damp-proofing:** The A/E shall design damp-proofing to comply with applicable codes and standards.

**B. Concrete Brick and Mortar Types:** Concrete brick shall be specified as ASTM C 55, type I, grade N; mortar shall be specified as ASTM C 270, type M, except for quantities less than 60 L (2 ft<sup>3</sup>), where packaged mix complying with ASTM C 387, type M may be used.

**C. Concrete Strength:** Concrete strength shall be specified as 20.7 MPa (3,000 psi) minimum, twenty-eight day compressive strength, with a maximum 10 mm (2/5 in.) aggregate.

---

## 11.4.3 Outside Plant (OSP) Pull Boxes/Handholes

### A. Metal Pull Boxes:

1. Metal pull boxes shall be cast aluminum, sized as indicated, with outside flanges, and recessed, gasketed cover for flush mounting.
2. A non-skid finish shall be provided on the cover, with a cover legend, "COMMUNICATIONS."

### B. Non-metallic Pull Boxes:

1. Non-metallic pull boxes shall be of a molded high density polyethylene. The flange around the base shall prevent frost damage from heaving or tilting.
2. Non-metallic pull boxes shall be placed at a depth of 914 mm (3 ft.) to the top of the box.
3. The cover shall be of high density polyethylene with a cover legend, "COMMUNICATIONS."

# Section 11.5

## AudioVisual Systems

---

### Contents

11.5.0 Introduction

11.5.1 Audiovisual

11.5.1.1 Closets

11.5.1.2 Cabling

11.5.1.3 Conduit

11.5.1.4 Floor Boxes and Wall Plates

11.5.1.5 Display Devices

11.5.1.6 External Devices

11.5.2 General Notes

## 11.5.0 Introduction

This section describes audiovisual systems requirements.

### 11.5.1 Audiovisual

All Audiovisual (AV) requirements shall be coordinated with the equipment supplier.

#### 11.5.1.1 Closets

##### A. Cable Termination Locations:

1. AV cabling shall terminate in an AV equipment rack in the nearest telephone closet, intermediate distribution frame (IDF), or main distribution frame (MDF) unless otherwise determined by the collaborative technology innovation and video services group (NIH/CT/OD/CTIVS) engineering staff.
2. Local use items such as user interface devices shall be located in a small professional AV rack, podium, or millwork in the room as determined by the NIH/CT/OD/CTIVS engineering staff.

**B. Electrical Outlet:** Each rack shall have a dedicated 20-A circuit. Two NEMA L5-20R receptacles shall be provided per rack.

#### 11.5.1.2 Cabling

##### A. Cable Types:

1. Audio cabling shall be 2C:22 shielded.
2. Composite cabling shall be RG-6.
3. Red-green-blue-horizontal-vertical (RGBHV) cabling shall be RG-174.
4. Balun and data or data only cabling shall be CAT5e or CAT6 as specified by manufacturer.

**B. Cable Bandwidth:** RGBHV and balun cabling shall have sufficient bandwidth to support 1,080 pixel signals for a distance of 45.8 m (150 ft.).

**C. Powered Balun:** S-video and RGBHV connectivity shall be provided via powered balun as feasible.

**D. HD cable Length:** HD cabling (i.e., HDMI and DVI-D) shall not exceed 15.2 m (50 ft.) in length without the use of a balun or cable equalizer.

**E. Plenum Rated Cable:** Plenum cabling shall be used in all circumstances where cabling does not pass directly through conduit for the length of the run.

#### 11.5.1.3 Conduit

**A. Straight Run:** All AV conduits to floor boxes shall be direct pulls (home runs) from the rack location.

**B. CIT Pathways:** No AV cabling shall be pulled through CIT data cabling pathways, including cable tray.

##### C. Conduit Size:

1. All floor box cabling shall be pulled through 51 mm (2 in.) rigid conduit, unless otherwise noted.
2. All single-gang endpoint cabling shall be pulled through 25 mm (1 in.) rigid conduit, unless otherwise noted.
3. All double-gang endpoint cabling shall be pulled through 32 mm (1-1/4 in.) rigid, unless otherwise noted.

#### 11.5.1.4 Floor Boxes and Wall Plates

**A. Floor Installation:** All AV cabling to the floor shall be pulled through floor boxes.

**B. Size and Type:** AV floor boxes shall measure a minimum depth of 102 mm (4 in.) and shall feature separate compartments for data, power, and AV.

**C. Poke-throughs:** Poke-throughs are only acceptable as a retrofit last resort. Poke-throughs, if used, shall be open pass throughs and feature no connectors, cabling, or power other than that necessary for AV connectivity.

**D. Wall Plates:** Double-gang wall plates shall be specified for all connectivity points, unless otherwise noted.

**E. Mounting Height:** Receptacle heights shall be determined in the field, unless otherwise noted.

### 11.5.1.5 Display Devices

#### A. Flat Screens Display:

1. **Types:** Flat screens displays shall be liquid crystal display/light-emitting diode (LCD/LED) or plasma. The standard plasma screen shall be 1.27 m (50 in.) diagonally. The standard LCD/LED screen size shall be 1.17 m (46 in.) diagonally.
2. **Connectivity:** Flat screen displays shall be professionally connected for AV usage, with the following installation requirements: high-definition multimedia interface (HDMI) and/or digital visual interface (DVI) for digital video connectivity and video graphics array (VGA); and/or RGBHV (one line for red, one for green, one for blue, one for the horizontal sync and one for the vertical sync) component, S-video, and composite for analog video connectivity, component connectivity, S-video connectivity, and composite connectivity.
3. **Audio Reproduction:** Audio reproduction for isolated wall mounted flat screen systems shall be provided by attached speakers.

#### B. Projection Systems:

1. **Rating:** Projectors shall be rated 4,000 lumens full white at a minimum.
2. **Resolution:** The native resolution of a flat screen display device shall be high-definition (HD) 1080 (1920 × 1080) or better. The native resolution of a projector shall be HD 720 (1280 × 720) or better. Video to any display device shall be scaled to the highest possible resolution whenever possible.
3. **Mounting Types:** Projection systems shall be ceiling mounted or portable.
4. **Projection Screen Mounting:** Projection screen mounting hardware supported to slab shall be provided at location(s) to be determined. Mounting hardware shall feature threaded rod or channel in a 610 mm × 610 mm (2 ft. × 2 ft.) matrix mounted between 305 mm (1 ft.) and 610 mm (2 ft.) above grid; and shall be

sufficient to support 39 kg (85 lb.) dead weight, unless otherwise noted. Flat screen mounting backing, in the form of 18 gauge minimum steel attached to stud, shall be provided at a location to be determined. Backing shall be sufficient to support 181 kg (400 lb.) dead weight on a 610 mm (2 ft.) moment, unless otherwise noted.

### 11.5.1.6 External Devices

**A. Camera Type:** Cameras shall be S-video capable.

**B. Ceiling Microphones:** Ceiling microphones shall not be used.

**C. Speaker Voltage:** Speaker systems shall be 70V unless otherwise noted.

**D. Speaker Support:** All ceiling speakers shall be individually supported to the slab or other ceiling support. If the ceiling is too high for contractor access, post grid, tie points, or cross braces shall be provided between 305 mm (1 ft.) and 610 mm (2 ft.) above grid. Ceiling speakers shall be supported using 18 American Wire gauge (AWG) steel wires.

**E. Projection Screen Mounting Hardware:** Projection screen mounting hardware supported to slab shall be provided at location(s) to be determined. Mounting hardware shall feature threaded rod or channel mounted between 305 mm (1 ft.) and 610 mm (2 ft.) above grid and shall be sufficient to support 181 kg (400 lb.) dead weight, unless otherwise noted.

## 11.5.2 General Notes

#### A. Responsibility:

1. NIH/CT/OD/CTIVS is not responsible for carpentry, millwork, electrical work, or painting.
2. NIH/CT/OD/CTIVS is not responsible for replacing or cutting grid-work around ceiling-mounted devices, including electric screens.

**B. Ceiling Tile Replacement:** Replacement of acoustic tiles shall be provided for any installation featuring ceiling mounted devices.

# Section 11.6

## Antenna and Miscellaneous Systems Requirements

---

### Contents

#### 11.6.0 Introduction

#### 11.6.1 Antenna

##### 11.6.1.1 Distributed Antenna System

##### 11.6.1.2 System Architecture

##### 11.6.1.3 System Extended Architecture

##### 11.6.1.4 Wireless LAN (WLAN) Architecture

##### 11.6.1.5 Third Party Equipment Interface

##### 11.6.1.6 Wide Area Services Equipment (Cellular/PCS, Two-Way, First Responder, and Paging)

##### 11.6.1.7 Access Point Equipment

##### 11.6.1.8 Enabled Devices and Software Applications

#### 11.6.2 Miscellaneous Systems

##### 11.6.2.1 BAS, Utility Monitoring, and Security Systems

##### 11.6.2.2 Elevator Room Support

##### 11.6.2.3 Renovation Work

##### 11.6.2.4 Cable TV System



## 11.6.0 Introduction

This section describes antenna and other communication systems requirements.

## 11.6.1 Antenna

### 11.6.1.1 Distributed Antenna System

**A. System Capability and Compliance:** The distributed antenna system is a broadband, in-building, antenna system designed for the transmission of multiple radio-frequency (RF) signals simultaneously over a passive antenna infrastructure. This system shall be compatible with the existing distributed antenna system.

**B. Accommodation of Existing Systems:** The basic distributed antenna system shall accommodate a broad range of wireless services operating between 400 MHz to 2400 MHz (such as two-way radio, first responder, paging, cellular, and PCS, Wi-Fi and others) and shall be expandable to accommodate additional wireless services in both the 150 MHz (VHF) and 5800 MHz (802.11a) frequency bands.

**C. System Design:**

1. The distributed antenna system provider shall provide the RF expertise, engineering, and operations teams that can configure the distributed antenna system to provide fully engineered, comprehensive coverage throughout the facility and overall wireless systems capacity to meet even the most demanding services and applications needs.
2. The following products and services shall be provided as follows: project scope, site survey, wide area services (WAS) design, wireless portals, wireless local area network (WLAN) design, customer design documentation, antennas, installation, project management, integration of wireless services, testing, and acceptance.

**D. System Accessibility:** The distributed antenna system shall deliver wireless accessibility everywhere in the building, shall be accessible by multiple users, using

multiple technologies and applications, and shall have a predictable level of reliability equivalent to other building utilities such as electricity and air conditioning.

### 11.6.1.2 System Architecture

**A. Single Point Connection:** The distributed antenna system shall provide a single point of connection for all of the WAS providers' equipment such as two-way radio, first responder, paging, cellular/PCS, 3G, etc. The system's portal shall combine all of the different signal inputs onto a single riser cable, which is distributed vertically throughout the building. At each segment this signal energy shall combine with the RF signal outputs from the local area services equipment located on each floor (such as WLAN, location services, enterprise voice, monitoring, building automation, security, etc.) and is transmitted in a combined fashion throughout the segment over a highly engineered network of RF distribution cables and broadband antennas.

**B. Passive Structure:** All of the individual components that make up the distributed antenna system (including the portal, vertical riser cables, horizontal distribution cables, and broad-band antennas) are passive in nature; require no electrical power, software, or ongoing management or monitoring; and are designed for many years of reliable and unattended operation.

### 11.6.1.3 System Extended Architecture

**A. Optical Repeater:** For individual buildings (or multi-building campuses) that exceed the capacity of a single distributed antenna system zone, the distributed antenna system can be expanded with third party RF optical repeater equipment.

**B. Extended Architecture Operation:** The extended architecture involves connection of the wireless portal from the first distributed antenna system zone directly onto the WAS providers' carrier equipment. RF optical repeaters are then used to extend each carrier's RF signal out to each of the adjacent buildings where it is connected onto the wireless portal serving that zone. In this manner, a single distributed antenna system zone can be extended to create a system of virtually any size and capacity.

### 11.6.1.4 Wireless LAN (WLAN) Architecture

**A. Capacity and Coverage:** The distributed antenna system shall provide the WLAN architecture with the dual concepts of “layered” capacity and deterministic RF coverage.

**B. Layered Capacity Operation:** Layered capacity means the combining of the RF signals from multiple 802.11 access points (APs) (up to three 802.11b/g APs, or in multiples of three 802.11a APs) over a single coverage area. This is achieved by passively isolating, filtering, and combining the AP output signals onto a single RF stream.

### 11.6.1.5 Third Party Equipment Interface

**A. Open Architecture:** The distributed antenna system shall be designed based on open architecture concepts and is implemented entirely within the bounds of an open system interconnection (OSI) layer 1 definition. This allows for the connection of multiple systems and devices without the need for proprietary interfaces or consideration of any specific layer 2 or layer 3 signaling limitations.

**B. Compatibility Partner Program:** The distributed antenna system shall be part of a compatibility partner program to provide NIH with the means to verify interoperability between the distributed antenna system and any third party systems, devices, and applications. This program shall ensure the allocation of resources required to address all of NIH network interface needs and priorities. The distributed antenna system shall have a compatibility laboratory where the distributed antenna system engineers test and evaluate directly with the product vendor any devices or technologies that a customer may want to deploy over the distributed antenna system.

### 11.6.1.6 Wide Area Services Equipment (Cellular/PCS, Two-Way, First Responder, and Paging)

**A. Coverage:** The distributed antenna system coverage designs shall be based on the assumption that each WAS provider shall provide:

1. RF connectivity at each connection port on every wireless portal, at a signal level of +28 dBm per RF channel.

2. Sufficient RF filtering on each of their RF connections to prevent interference with other RF signals of other WAS providers that may be operating on the inner wireless system in adjacent frequency bands.

### B. Additional Amplification and Filtering:

1. In the event that any WAS provider is unable to provide sufficient amplification or filtering equipment to meet the distributed antenna system design requirements, further amplification or filtering equipment may be necessary prior to connection of that WAS providers’ signal onto the distributed antenna system.
2. The distributed antenna system shall be able to provide the additional amplification and filtering equipment required for each WAS provider’s connection, such as RF optical converter equipment, off-air bidirectional repeater equipment, or passive band-specific filter devices.

### 11.6.1.7 Access Point Equipment

**A. Compatibility:** The distributed antenna system shall be compatible with 802.11a/b/g access points on the market today. Specific compatibility testing is available to verify antenna port configurations, output signal levels, and to complete the detailed design of the distributed antenna system, as required.

**B. RF Signal Levels:** Unless otherwise noted, the distributed antenna system WLAN architecture shall be designed based upon access points having easily accessible external antenna ports and the following minimum 802.11 RF signal levels:

1. +17 dBm per 802.11a channel
2. +20 dBm per 802.11b channel
3. +15 dBm per 802.11g channel
4. +23 dBm per 802.11n channel

**C. Modifications:** In the event that the specific model of 802.11 access point selected by NIH cannot provide either external antenna port access or the minimum signal strengths mentioned above, the distributed antenna system design shall be modified to accomplish the NIH requirements.

### 11.6.1.8 Enabled Devices and Software Applications

**A. Existing Systems:** The distributed antenna system has been deployed successfully with many different combinations of 802.11 enabled devices and software.

**B. NIH System Needs:** As different manufacturers' devices and software applications have varying design needs, it is critical to the successful design and implementation of the distributed antenna system that the contracted distributed antenna system shall be advised of all 802.11 enabled devices and software applications planned for deployment on the system, as NIH needs dictate.

**C. Interoperability:** In the event that the specific combination of devices or applications planned for deployment is new to the contracted distributed antenna system, the contracted distributed antenna system provided shall make available its compatibility partner program to verify interoperability prior to connection onto the distributed antenna system.

---

## 11.6.2 Miscellaneous Systems

### 11.6.2.1 BAS, Utility Monitoring, and Security Systems

**A. Building automation system (BAS), utility monitoring, and security systems** vary widely in requirements for connections used to monitor their systems; however, the following shall always apply:

1. Provide an electrical metallic tubing (EMT) conduit pathway(s) back to a closet or closest cable management system.
2. The pathway shall never exceed 90 m (295 ft.) in length when utilizing LAN communications.

3. Center for Information Technology (CIT) shall provide the cabling via an NIH cabling contractor to support these requirements and shall assist in determining cable types required to support the installation.
4. CIT shall participate in this design process to ensure that the connections required can be supported. Refer to [Section 11.2.1.9 Network Equipment Electrical Requirements](#).

### 11.6.2.2 Elevator Room Support

**A. Wall Phone:** Elevator rooms require a pathway to support a wall phone located at 1.2 m (4 ft.) above the finished floor and a pathway to support each controller.

**B. Connection to Closet:** Elevator rooms shall be provided with an EMT conduit pathway(s) back to a closet or closest cable management system, not to exceed 90 m (295 ft.) in length.

### 11.6.2.3 Renovation Work

**A. Abandoned Cabling:** All abandoned cabling in renovated areas shall be removed and recycled in accordance with CIT's recycling requirements.

**B. CIT Responsibility:** CIT shall be responsible for disconnecting and labeling all cables to be removed.

### 11.6.2.4 Cable TV System

**A. When Required:** Some buildings on campus are wired for cable TV.

**B. Cable TV Outlets:** Cable outlets shall adhere to the requirement of [11.3.3 Horizontal Pathways](#), for cabling to be provided by the local cable TV company.

# Section 11.7

## Security Systems

---

### Contents

11.7.0 Introduction

11.7.1 Security Systems

11.7.1.1 Security System Wiring, Conduit, Cabling, and Labeling

## 11.7.0 Introduction

This section describes security system requirements.

### 11.7.1 Security Systems

All security system requirements shall be coordinated with the Division of Physical Security Management (DPSM). See Section 1.13. In addition, refer to NIH Policy Manual Chapter 1381 for additional requirements.

#### 11.7.1.1 Security System Wiring, Conduit, Cabling, and Labeling

##### A. Wiring:

1. All wire and cable shall be installed in accordance with the security system and equipment manufacturer's requirements and instructions, national, state and local code requirements.
2. All wiring not in conduit or cable tray shall be run concealed within walls or above accessible ceilings. All cables run exposed above accessible ceilings shall be plenum rated and neatly run and fastened to the structure at least every 3 m (10 ft.). All cables run exposed in the security riser rooms shall be plenum rated and neatly bundled and run in a dedicated cable management system.
3. All Security Free Wiring shall be fastened to and labeled with the following:
  - a. J Hooks, cable/wire bundling will be labeled with Yellow and Blue definition strips
  - b. On the side of a Cable Tray with Yellow and Blue definition strips
  - c. J Hooks which are hung from independent ceiling mounted tie wires
  - d. J Hooks on the side of a Cable Management Tray with Yellow and Blue designation strips

4. All cable must be run continuous from device location to the final point of termination. No mid-run cable splices will be allowed.
5. Make all wiring connections with solderless devices, mechanically and electrically secure in accordance with manufacturer's requirements.
6. A single "system ground" point shall be established for the system. This system ground shall consist of a single grounding point to which all grounds in the system are connected. Under no conditions shall the AC neutral either in a power panel or in receptacle outlets be used for a reference ground. The contractor shall be responsible for establishing the ground point and ensuring that no ground loops are created.

##### B. Conduit and Junction Boxes:

1. With the exception of conduit for fiber optic cable, cabling inside poured concrete walls and ceilings, and cabling serving devices at APR doors; conduit is not required in the secured areas of the building. In unsecured areas, provide conduit system as described herein. The contractor shall be responsible for providing any additional conduits, junction boxes, and raceways as indicated or that are required to provide a quality installation. The contractor shall be responsible for ensuring that all conduit, back boxes and raceways meet equipment and wiring requirements for the system.
2. All security conduits will not be supported by any fire sprinkler systems.
3. All Security Junction Boxes (JB) will be secured by no less than one of the following:
  - a. Security Screws
  - b. Key Panel (JB)
  - c. Medeco Security Lock (when applicable)
  - d. Three keys to hard locks will be made and given to DPSM, Division of Police and the NIH Lock Smith.

**C. Cabling:**

1. NIH DPSM Outside Plant (OSP) includes right-of-way and route design; OSP space design (maintenance holes, ducts, vaults); underground, direct-buried, and aerial plant design; OSP cabling hardware; and OSP grounding, bonding and electrical protection systems.
2. The DPSM requires certain key aspects of pre installation work to be performed such as:
  - a. Right-of-way designation and Route Design
  - b. Cabling and Splicing Hardware
  - c. Grounding (earthing), bonding and electrical protection systems
  - d. Cable and Connector Types
  - e. Cabling Topologies, Pathways and Spaces
  - f. Bonding, Grounding (earthing) and Electrical Protection
  - g. Maintenance and Restoration
  - h. Media Selection and Special Design Considerations

**D. Labeling:**

1. All Security Free Wiring shall be labeled with the following:
  - a. J Hooks, cable/wire bundling will be labeled with Yellow and Blue definition strips
2. Security wiring in cable tray shall be labeled with Yellow and Blue definition strips, including J Hooks which are hung from independent ceiling mounted tie wires and J Hooks on the side of a Cable Management Tray with Security Designation Strips (Yellow and Blue)
3. All cables shall be marked in common at both ends using a permanent method such as self-laminating write-on cable marking tape. Labeling shall agree with record drawings. Labels shall be visible and legible.
4. All terminals shall be permanently marked and shall agree with record drawings.
5. All connectors shall be marked with common designations for mating connectors. The connector designations shall be indicated on the record drawings.
6. All visible panel and control labels shall be silk-screened, engraved and filled, or engraved plastic laminate.
7. All security conduit installed will be labeled **yellow** and **blue** with the option of:
  - a. Permitted color spray paint around the conduit
  - b. Color Tape around the conduit
  - c. Color Band Glued around the conduit
8. All security conduits will be labeled every 7.6 m (25 ft.) starting from the beginning Junction boxes (JB) to the end location.
9. Security yellow and blue definition will be 13 mm (1/2 in.) in width and space side by side covering around the conduit.
10. All Security Junction Boxes (JB) where only security conduit is joined shall be labeled with 12 x 12, 14 x 14, 18 x 18 (JB):
  - a. Yellow and Blue definition strips on the center of the (JB)
  - b. Label with point of contact (POC) phone number
  - c. If the cable tray in which the J Hook is to be fastened has been installed by a government entity other than the DPSM (i.e., CIT, etc.) the contractor must first receive approval from that government entities representative before installation of hardware. If installation of hardware is denied, contractor must install independent ceiling mounted tie wire hardware.
11. When these standards conflict with other specified requirements, the most restrictive requirement shall govern. Any exceptions to requirements must be approved by the Director of DPSM.



**E. DPSM Security Building Systems:**

1. In general, the area shall be designed in accordance with the Level of Protection (LOP) requirements of the Facility Security Level (FSL), as determined by the Interagency Security Committee (ISC) Standards by the Director of DPSM.
2. Access to all sensitive areas shall be controlled with an approved electronic physical access control system. In addition, CCTV coverage and associated systems may be required. For specific physical security requirements contact the PO to coordinate with DPSM, see [Section 1.13](#). Building systems include spaces housing the following:
  - a. Main electrical switchgear and panels
  - b. Electrical branch distribution panels
  - c. Transformers and UPS
  - d. Transient suppression equipment

- e. Emergency generators and transfer switches
- f. Main telephone service, telephone branch distribution panels
- g. LAN servers and distribution panels
- h. Security systems panels
- i. Main control valves, fire pumps
- j. Filters and air purification equipment, HVAC systems
- k. Lactation rooms
- l. Lobbies

**F. DPSM CCTV Cameras Systems:** CCTV camera systems shall only be installed with the approval of DPSM, see [Section 1.13](#).

**G. Renovation:** Coordinate with DPSM prior to removing any physical security systems or hardware, see [Section 1.13](#).

# Chapter 12

---

## Special Process Piping Systems

# Section 12.1

## High Purity Water Systems

---

### Contents

12.2.0 Introduction

12.2.1 General Requirements

12.2.2 ADW Production Systems

12.2.2.1 ADW Production System  
Components

12.2.3 Barrier Facilities

12.2.4 Microbial Control

12.2.5 Distribution

12.2.6 Disaster Mitigation

12.2.7 Materials

12.2.8 Startup and Verification

## 12.1.0 Introduction

Water utilized for research is a reagent. The quality and purity of water as delivered at the point of use can affect research results and introduce variables. This section addresses the production and distribution of high purity (purified) water systems used for research, equipment feed, and pharmaceutical applications. In addition to the requirements listed in this section, comply with [Appendix N: High Purity and Animal Drinking Water System Sanitization, Lab Testing, and Acceptance](#).

### 12.1.1 Purified Water System: Common Requirements

**A. Water Quality:** Purified water to laboratories and laboratory equipment shall meet the requirements of [Table 12.1.1](#), except as otherwise required and approved for limited, special applications.

**B. Cross-Connections and Contamination:** Designs shall be free of cross-connections and unprotected hazards that might plausibly contaminate the distribution system.

**C. Basis of Design, Use of Standards:** The required product water quality shall be documented in the Basis of Design (BOD) and the design specifications in conformance with this section of the DRM. The BOD shall demonstrate the capability to reliably produce, deliver, and maintain that water quality. The A/E may consider the guidance of current reference standards for purified water used in various industries recognizing the limitations of such standards. Final analytical water quality for individual research applications shall be determined fit for use by the researcher.

***Rationale:** Various industry standards for water quality are available with useful reference data; however, many standards do not adequately consider individual parameters required for specific uses, consequences of particular stated values or measurement requirements, interrelationships and consequences of contaminants, or requirements to reliably maintain required system water quality and flexibility of central systems as applied in biomedical lab applications. There are also*

*conflicts within and between some of the standards produced by different organizations, and their applicability does not necessarily reflect the way central systems for biomedical applications are typically operated.*

*Resistivity limits of several prominent standards are unacceptable to many lab equipment manufacturers. Current total organic carbon (TOC) limits at Type II and III waters can be insufficient for many biomedical applications and may not provide for adequate long-term central system water quality with low maintenance. Type I contaminant class parameters may not be cost-effective to maintain centrally. CLSI C3-A4 can provide additional guidance.*

**D. Minimum Specified Parameters:** At a minimum, the design conductivity/resistivity, TOC, particulate/colloid, and microbial parameters shall be indicated, along with the proposed treatment process and water source. Definition of suitable endpoint water quality must be verified by the user to be fit for the application.

***Rationale:** A clear definition of the delivered water quality, method of preparation, and long term control is essential to facilitate proper design, procurement, and ongoing maintenance of the system and for accurate communication of the supply quality. The use of process terminology e.g., reverse osmosis (RO) and deionized (DI) water is not adequate, and reference only to conductivity/resistivity water does not reflect the presence of a number of nonionizing contaminants.*

**E. Control and Monitoring Provisions:** The production and distribution systems shall include automatic instrumentation, equipment, alarms, and sampling ports to facilitate the monitoring of performance parameters and the system. Instrumentation shall be provided after each step of the treatment process, with additional instrumentation for product water located at point(s) in the system to effectively represent the delivered water quality and to provide effective process control. Locating monitors only at the end of a series of components is unacceptable. Indicating type instrumentation shall be provided for clear verification of critical status elements (e.g., flow and pressure). Control for large

systems shall be either by local programmable logic controller (PLC) with integrated controls or by a local “central” PLC with interconnection to local component PLC’s. Set point changes shall be keyed by individual user or supervisory passcode, and programs shall allow for at least ten distinct passcodes changeable only by an on-site administrator.

**F. Sampling Valves:** Sampling valves are required to monitor component and system performance and to validate major process instrumentation. Sampling valves shall be selected and configured to preclude dead-legs, be accessible, and located in a clean space away from interferences. Sampling valves shall have a discharge port small enough to achieve a laminar flow stream with a velocity of at least .305 m/s (1 ft./s) at a flow rate of 1 lpm (0.25 gpm). Downstream of the purified water production, sampling valves shall be sanitary type stainless steel with mid-stream collection probe and sanitary tri-clamp connection, engineered for high purity sampling. High purity needle type sampling valves may be used. Ball valves and diaphragm type are unacceptable. A sanitary-type sample valve shall also be provided at the following locations:

1. **Supply Main:** Common supply main (immediately downstream of all treatment components including filters and ultraviolet (UV) light generators) within the same room where the production system is located and prior to any use outlets.
2. **Return Main:** Common main returning from the system, after the last use point, located within the room housing the production system, but prior to passing through any filters, UV, storage tank, or other treatment component.

*Rationale: These provisions facilitate accuracy of data for offline validation and troubleshooting without inducing system contamination.*

**G. Instruments:** Instrumentation shall be provided and calibrated in consideration of the required water quality, accuracy for the system application, and reference conditions, installed and commissioned per manufacturer requirements. Instruments shall be provided with manufacturer calibration reports, and included in O&M manuals. The method of connecting instrumentation to the system shall not compromise water quality. Manufactured dead-leg free instrument fittings,

fluoropolymer diaphragm isolators (e.g., for pressure and level transmitters), sanitary wells, and gauge guards are required after the RO membrane. Fill fluids shall be FDA approved. Gauges shall be inert liquid filled.

**H. TOC Monitors:** TOC monitors shall be online type for applications requiring less than 50 ppb and may be online or offline for other applications. The A/E shall specify monitors with capability for the types of prevalent organic contamination in the site water supply and for use compatible with the water quality at the point of installation; of sufficient quality, accuracy, and low maintenance balance to capital cost. Offline TOC monitoring is subject to conformance with the system design configuration to reliably assure low TOC, and for applications where TOC and microbial control are not critical parameters for the application (e.g., some scale control applications), subject to prior approval of ORF. A TOC monitor shall be provided on the main return and preferably also on the main supply, analyzer may be shared. A sanitary sample port shall be provided at the TOC sensor location.

*Rationale: TOC is a significant factor to water quality, representing broad classes of contaminants that can introduce research variables, influence microbial and particle control, system reliability and operating costs.*

**I. Resistivity Meter:** Each system shall include an online resistivity meter provided at least on the supply main leaving the system and the main return.

**J. Additional Required Instrumentation:** Other required automatic instrumentation includes return loop flow, pressure, and temperature (upstream of the back pressure regulator for each return loop), individual pump status monitoring, as well as individual component instrumentation described in this section.

**K. Pressure Ratings:** With the exception of atmospheric tanks and where greater pressures are required, a minimum working pressure rating of 1,030 kPa (150 psig) (at approximately 23°C [70°F]) is required for pressurized tanks, filter housings, media vessels (not RO housings), softeners, and components.

**L. Water Contact Materials and Components:** Refer to [Chapter 6, Exhibit 6.3](#) for approved piping system materials and joint methods, including for vendor-furnished

production equipment. PVC is not permitted after the carbon bed or for any flexible hoses (including connections of service exchange equipment). All plastics shall be in conformance with 21 CFR 177.1520 or 177.2510. All materials shall be compatible with the process fluid and sanitization methods. All materials on the permeate side of the RO membrane shall be inert and non-contaminating to the required water quality, with avoidance of dead-legs and crevices. Products with bactericidal impregnation or high levels of ionic or TOC elution are prohibited. Polypropylene, polyethylene, ethylene-propylene rubber, nitrile, and butyl rubber shall not be utilized for any system where ozone will be utilized. Natural rubber and other materials which provide nutrients to bacteria, or any material which is subject to degradation associated with sanitization methods or due to low conductivity fluid is prohibited. Ultrapure and water for injection (WFI) applications shall additionally be in conformance with USP Class VI or ISO 10933 equivalent, and shall be PVDF or 316 L stainless. All materials shall be specified to be stored, handled, installed, tested, flushed, and sanitized following methods to prevent introduction of unacceptable levels of contaminants.

**M. Chemical Resistance:** All materials downstream of the RO membrane and throughout the distribution system shall be suitable for routine sanitization with hydrogen peroxide/peracetic acid standard solutions.

**N. Piping Materials and Components Pressure Ratings:** All materials shall be selected as appropriate for required system working pressures and surge pressures. Required working pressure ratings for piping system and components shall be based on 50 year values and still be suitable for operation. Piping system materials and joints shall be in accordance with [Exhibit 6.3 Piping Designation, Material, Fittings, and Joints](#).

**O. Elastomers Selection, Specification, and Verification:** Elastomers shall be selected for compatibility with selected sanitization methods and maintenance of water quality. Generally, only 21 CFR 177.2600 FDA or USP Class V or VI (or ISO 10933 equivalent) compliant grades of Viton/FKM/FPM, PTFE/PFA or silicone shall be utilized downstream of the activated carbon and throughout the distribution system. Where systems are constructed of polypropylene, FDA grade of ethylene propylene diene monomer (EPDM) rubber may also be utilized. The A/E shall specify and review certifications of completed elastomer seals.

***Rationale:** These materials ensure durability and compatibility with a wide range of disinfectants. EPDM is permitted for polypropylene systems as such systems cannot be used or retrofitted for ozonation. Elastomers can contain significant contaminants and handling and curing processes can result in TOC elution and/or ionic contamination necessitating product certification.*

**P. Passivation:** All stainless steel components and systems shall be passivated in accordance with ASTM A967 and ASTM A380 by firms specializing in passivation of high purity system components. The A/E shall specify full conformance, testing, and traceability in accordance with these standards, including proper rinsing of surfaces to render them chemically inert, clean drying, and appropriate post-passivation packaged to protect from subsequent contamination.

**Q. Pharmaceutical, USP, Aquatic, and Animal Water Supply and High Purity System Interconnections:** Purified water systems of differing type, source, or application and serving different functions such as those listed shall not be interconnected.

***Rationale:** This provides protection of critical systems from contamination, supply quality fluctuations, chemical, microbial, and sanitant chemicals. While interconnection of systems is sometimes beneficial as a backup, a number of hazards can be created by these arrangements.*

**R. Documentation:** The A/E shall ensure that the O&M manuals contain appropriate water quality maintenance guidance. At a minimum, a general outline of anticipated requirements shall be documented in the project BOD and coordinated with the NIH.

**S. Engineered Calculations, Documentation, and Pipe System Simulation Modeling:** Comprehensive process engineering calculations are required for the design and selection of all components and equipment and shall be based on at-site water quality analysis. The use of computerized pipe flow hydraulic modeling/system simulation software is recommended, is required for all new work with more than 75 outlets, shall be utilized to simulate and optimize the entire system performance and component interactions (including pumps and control valves) and to validate proper flow, velocity,



Reynolds number (Re), pressure, set points, equipment selections, orifices, balance valves, surge pressures, and other critical factors under each operating condition (including peak demand and static conditions). Piping flow modeling software shall be sufficiently robust for use with high purity piping systems of the type, size, and complexity being provided. All calculations shall be submitted for review and approval and the pipe flow modeling print sheet (showing the nodes and legible output data) shall be included in design documents and record submission as informational sheets and updated for any field changes, additions, deletions, or other modifications during construction. The A/E shall model for each specified piping material and associated piping diameter to ensure accurate conditions, and shall update the model where any substitution of materials (e.g., pumps, valves, or differing manufacturers of piping utilizing different internal diameter systems) is permitted.

**T. Piping and Instrumentation Diagram/Drawings (P&ID):** Full P&ID documents and sequences of operation shall be provided to the NIH for review and approval.

**U. Microbial and Particle Control:** All purified water systems shall be designed to accommodate routine sanitization, limit microbial contamination, TOC, and control biofilm and particles. The appropriate method for sanitization and removal of sanitization residuals shall be evaluated, outlined in the BOD, and confirmed with the program and the ORF early in the design planning stage.

**Rationale:** The selection of system sanitization can have an effect on systems operation, materials selection, design arrangement, disruptions/impact to research, and operating costs.

**V. Standby Power:** Purified water systems, including PLCs and distribution/circulating pumps, shall be on standby power.

**Rationale:** Purified water supply disruption may result in negative consequences, including backflow, microbial contamination, pressure surge/particle issues, air infiltration, or significant damage if sanitation is in progress.

**Table 12.1.1 Minimum Design Quality Parameters (at Point of Use) and Associated Monitoring Levels for General High Purity Feedwater Service to Laboratories, Polishers, and Lab Sinks**

Parameter	Design Requirement	Alert Level	Maximum Corrective Action Level
Resistivity <sup>a,b</sup> (min/max), 25°C	0.5–1 MΩcm	< 0.5 MΩcm, > 3 MΩcm	< 0.5 MΩcm > 5 MΩcm
TOC (max) <sup>c</sup>	≤ 10–20 ppb	> 20–50 ppb	> 200 ppb
Microbial <sup>c,d</sup>	≤ 10 CFU/ 100 mL	> 100 CFU/100 mL	> 1000 CFU/100 mL

<sup>a</sup> Where the required minimum resistivity cannot be reliably achieved even with two-pass RO and use of a membrane contactor, lower limits may be accepted if it can be confirmed that values of resistivity at the use points (including at the inlet connection to water polishers and sink taps) will be between 0.3–0.5 MΩcm 25°C) upon evaluation of proper on-site water analysis and consideration of lowest RO reject that may be present (prior to membrane service requirement, typically 90%); however, design below 0.5 MΩcm shall be justified and avoided. Reduction below 0.5 MΩcm shall not be used as a means of waiving two-pass RO and this provision does not waive achieving other required contaminant limits. The upper portion of this range (0.75 to 1MΩ) may be required for many lab applications over the life of the facility and two-pass ensures robust and reliable water quality for the range of primary contaminant parameters.

<sup>b</sup> Online values for resistivity.

<sup>c</sup> System design shall minimize TOC and microbial contaminants to achieve water quality and minimize frequency of system sanitizations.

<sup>d</sup> Microbial count is based on plate count methods in this section of the DRM. Direct count epifluorescence microscopy values may be higher and must consider viable versus non-viable organisms.

**W. Drain Air Gap:** All drains shall be provided with a plumbing code defined fixed air gap. Common drain manifolds serving multiple tanks or other components shall be arranged to prevent backflow (including from

one tank or system component into another), and any check valves used for that purpose shall be located on the discharge side of individual equipment drain valves to prevent fouling or microbial contamination.

**X. Bypasses:** Where a bypass is provided around any component or where stagnancy could occur, such bypass shall be configured to avoid dead-legs and be fully drainable when not in use.

## 12.1.2 Centrally Distributed High Purity Water

**A. Description:** For most laboratory applications, a centrally distributed purified feedwater arrangement with point of use polishers shall be utilized. This shall consist of a centrally produced and distributed purified water supply dispensed to sink taps, select equipment, and to point of use polishers as required to achieve final ultra-high purity (UHP) water for analytical purposes.

**B. Small System Exemption:** The provision of point of use production and treatment systems (in lieu of central purified feedwater systems), may be provided for small systems encompassing a total of not to exceed approximately 20–30 outlets with program approval. Such point of use treatment systems shall be capable of delivering both purified RO and ultrapure waters as required, except that well-designed point of use stills may be utilized where acceptable to the program. Such systems shall be limited to application at the point of use or point of dispense and not piped to other areas. Arrangements relying upon dispense and storage of purified water in containers and transport to individual labs are unacceptable. Lab planning and utilities for such spaces shall ensure sufficient utility and spatial provisions for these types of treatment systems at the point of use.

**C. System Configuration Overview:** Central high purity water systems supplying purified water/feedwater to laboratories shall be configured to include a direct source potable water supply with point of production backflow protection, particle and fouling control provisions as appropriate to the worst case incoming supply conditions, ion exchange type water softening for scale

control, activated carbon media beds in series, two-pass RO, purified water storage tank, UV for disinfection and/or organics oxidation, final 0.1 µm or 20 nm hydrophilic microfiltration. Continuous recirculation with avoidance of dead-legs to each use point and arranged for continuity of supply at required flow and velocity to each laboratory with minimum flow rate maintained regardless of user consumption. Membrane degasification shall be provided as required between the RO passes or after RO as appropriate, especially where high alkalinity waters are present and for large systems. Electrodeionization (EDI) is not normally required, but shall additionally be provided where the minimum required water resistivity cannot be obtained after double pass RO and membrane degasification. Blending or adjustment shall be provided to control conductivity with EDI within required limits. The system shall be provided with monitoring to ensure the minimum water quality requirements will be maintained, and a suitable routine microbial control approach is required. EDI shall not substitute for two-pass RO.

*Rationale: This approach helps ensure consistent, reliable, low maintenance systems that provide high-quality feedwater suitable for most applications and compatibility with typical scientific equipment. This allows individual well-selected polishers to produce required UHP analytical water qualities cost-effectively as appropriate to individual applications with control of all contaminant classes.*

**D. Water Quality:** Laboratory feedwater systems serving polishers and purified water taps at sinks and other lab uses shall comply with the requirements of [Table 12.1.1](#). Alert levels and action limits indicated are informational for the designer and recommended for maintenance of the purified water systems. TOC and resistivity alarms shall activate at alert levels as indicated.

*Rationale: Water quality requirements are driven by scientific need at the point of use, limitations of polishing equipment, and parameters to reliably maintain water quality without excessive maintenance/disruptions. Users expect delivered water quality to be pure, inert, chemically and microbially safe. The required parameters identify*

*the limits for significant contaminant concerns. Resistivity limits reflect a cost-effective baseline and program suitability and compatibility with limits for typical lab equipment. TOC values are limited to control the entire class of organic contaminants and to limit available nutrients for microbes. Failure to control bacteria can result in system contamination (including particles, decomposition byproducts, algae, and ionic effects from CO<sub>2</sub>), ultimately affecting end use water quality. There can be interrelationships between failure to control one contaminant class and presence of other contaminants. Production and maintenance of central UHP water is not typically cost-effective to maintain. Use of high resistivity water may void some lab equipment warranties.*

**E. Documentation:** Calculations shall demonstrate proper engineering of system and component sizing, delivered water quality, face velocity through beds, backwash velocities, volumetric flow rates, RO membrane selection and configuration, UV size and transmission, appropriate equipment selection, chemistry and process chemical byproducts, water supply analysis. Other analyses shall be provided that justify the design, materials, component selection and sizing approach. See [Section 12.1.1 Purified Water System: Common Requirements](#) for additional requirements.

**F. EDI/Resin Bed Deionization and Organic Scavenging:** Deionization is not normally permitted except for final polishing at points of use (POU). Where deionization is required, EDI shall be utilized. 254 nm UV is required after deionization, followed a final 0.1 µm particulate filter. Resin bed deionization requires justification and preapproval. A resin trap is required. Neither EDI nor organic scavenging are a substitute for the required RO arrangement; however organic scavenging may be used where required in pretreatment systems (e.g., to protect carbon beds) due to high natural organic matter and EDI may be used to restore required resistivity.

*Rationale: There are limited applications where deionization (typically only EDI) may be justified. Deionization is typically used to remove oxidized components where degasification is determined technically inadequate or where resistivity must*

*be restored. Deionizers can leak TOC's, shed particles, induce microbial issues and are not cost-effective to operate. Organic scavenging beds may not address broad contaminant classes, and can induce contamination and additional operating costs.*

**G. Loop Return Polishing Restriction:** System water shall be circulated back through the tank, UV, and final particulate filter without additional polishing. Oxidizing UV may be used to address any trace TOC accumulated from the distribution loop. Where additional loop polishing is justified, the acceptable approach is to reclaim and reprocess through the second pass RO (with recovery of reject back to the first pass).

*Rationale: This is to avoid introducing potential contamination and unjustified operating cost.*

### 12.1.3 Point of Use Polisher and Complete Point of Use Production Systems

**A. Equipment Selection:** Currently at the NIH, point of use polisher and complete point of use production systems are not typically furnished as part of building systems construction. All systems connected to central purified feed water shall be capable of addressing ionic, organic, and microbial contaminants to deliver the required water quality and with features to prevent contamination of upstream systems. Well designed point of use stills or polishers inclusive of deionization, oxidizing UV, and ultrafilters or microfilters (using virgin resins) may be used. Point of use production units shall include reverse osmosis. RO pretreatment is optional where stills are used. DTR should be contacted for technical guidance where systems are required through the A/E scope. Provision of infrastructure, including space planning, adequate support, and utilities is required by the A/E and shall be shown in design documents. Polishers that avoid dead-legs and maintain circulation, including in the supply system, are strongly recommended.

**B. Planning and Arrangement:** Equipment locations shall be coordinated with the program management. A sink or other approved drainage provision is required near the equipment to receive drainage. Central purified feedwater shall be piped to a dedicated purified water dispense tap at the designated lab sink(s), and to polisher(s). Where point of use production systems are utilized, water may be dispensed directly from the unit without a sink tap where such units include provisions for both lower grade (typically ASTM D1193 type 2 or type 3) and higher grade UHP water or directly from a point of use still. Placement of equipment and dispense units shall not interfere with other lab requirements (e.g., eyewashes, faucet handles, drying racks, etc.).

**C. Equipment Drains/Air Gap:** Drains shall spill above the sink or appropriate indirect waste receptor with a configuration to maintain a fixed air gap (e.g., fastened stainless steel tube spilling over the sink) or utilization of a manufactured air gap fitting.

**D. Water Supply Connections, POU Polishers:** The supply and return (or in the case of an in-lab serpentine loop, the supply in and out) serving the polisher shall be stubbed out at the polisher location and fitted with a zero-static (sanitary T-valve) or approved equivalent arrangement located as close as possible to the polisher connection. The outlet port of the T-valve shall be fitted with a properly sized, non-contaminating pressure regulator where required based on feed water supply pressure and equipment requirements. The regulator shall connect to the T-valve with a sanitary (tri-clamp) connection. Immediately downstream of the regulator or zero static T-valve, a sanitary x PFA (perfluoroalkoxy) sanitary flare adapter shall be provided and a minimal length of PFA tubing shall be used to connect to the polisher using only high purity flare or sanitary tri-clamp (not push-connect) joints. The location of the zero static valve shall ensure that the uncirculated tubing length to the polisher operating valve is absolutely minimal, and in no case more than 305 mm (12 in.) long. The PFA tubing shall be covered with a loose fitting pigmented polypropylene, polyethylene, PVC or similar non-porous opaque jacket. PFA tubing and fittings shall be clearly marked to permit on-site verification. Where sufficient polisher information is not available to ensure proper rough-in location of the zero-static valve during construction, an additional normally open diaphragm valve shall be provided at the supply and return stub out

to the polisher to permit proper fit-out without cutting into the central system.

***Rationale:** The stagnant condition of water supplies to polishers can lead to contamination in upstream supplies. PFA tubing is required to minimize organics leaching out of long-term stagnant sections, which can compromise upstream systems. Positioning a zero-static valve at the connection minimizes this issue with current available equipment and allows for system sanitization to occur in some cases without disconnecting individual polishers.*

**E. Water Supply Connections, POU Production Systems:** The water supply for point of use production systems in typical lab applications shall be from the building's lab cold water supply. Point of use backflow protection is not required unless supplied from potable water or a backflow hazard specifically exists. Avoid push connect and compression fittings.

**F. Circulated Connections:** Purified water shall not be hard piped from polisher outlets to remote dispense points or in any manner that creates dead-legs in a system connected to the central purified water supply. Where remote points are needed, units with integrated recirculation remote dispense or provision of multiple units are required.

***Rationale:** Flooding, system contamination, and poor local water quality can occur due to poor quality installations and use of non-DRM compliant materials and tubing joints. Requirements should be coordinated with the equipment purchaser. Stagnancy at polishers, combined with inadequate polisher maintenance can contaminate upstream systems, even if equipment includes a point of use microfilter.*

**G. Ozone-Resistant Materials:** For central feedwater systems utilizing an ozonated water sanitization method, it is preferred that polishers incorporate ozone-resistant construction materials up to the first solenoid valve (typically PVDF, stainless steel, PFA, or other low-leaching, low-TOC, ozone compatible components with fluorocarbon (FKM) elastomer, (or where not available



compatible silicone may be used) but not polypropylene/polyethylene. PFA and PTFE encapsulated seals may also be used. Where available and cost-effective perfluoroelastomer is preferred for applications where regular seal, maintenance, or replacement would be impractical or not cost-effective.

## 12.1.4 Purified Water for Special Applications

**A. Water for Humidification:** Water quality that is at least Type III or Type IV water as specified in ASTM Standard D1193 shall be provided for heat exchangers where clean steam humidification is required. Purified feedwater that meets/exceeds these requirements and is prepared in accordance with [Section 12.1.2 Centrally Distributed High Purity Water](#) may be utilized if suitably configured.

*Rationale: Water supply for these applications is generally to prevent scaling issues.*

**B. Purified Water for Labware Washers, Autoclaves, and Glassware:** Provide purified water only where specifically required by the program or equipment manufacturer. These parameters shall be verified with the equipment manufacturer and program. Where purified water is required, it shall not be of lower quality than 0.33M $\Omega$ cm resistivity, 50 ppb TOC, and 100 CFU/100mL microbial, and produced from a treatment process inclusive of RO or distillation, or water prepared in conformance with [Section 12.1.2 Centrally Distributed High Purity Water](#). Some autoclave and special equipment applications may have significantly more stringent water quality requirements (e.g., clean steam and pure steam applications).

## 12.1.5 Production Systems: Common Requirements

**A. Water Testing:** A site-specific water supply analysis shall be prepared during the design stage to determine the degree of treatment required. The investigation of

water supply quality and determination of treatment methodologies shall consider seasonal and source variations in water supply quality. Where the source is inclusive of a surface water supply, at least one test shall be conducted on-site from a time when the surface waters source is active. At least two samples shall be taken and analyzed anytime sampling is conducted. Sampling analysis used for design shall be taken on-site and data more than 12 months old shall not be used for design.

1. Testing shall be carried out by a water quality lab accredited in accordance with ISO 17025 by a signatory to the International Laboratory Accreditation Cooperation (ILAC) mutual recognition agreement, within the scope of their accreditation. Sample collection shall be carried out either by the lab or under their direction by experienced personnel, following appropriate protocols for sample collection, handling, shipping and testing to ensure accuracy.
2. Testing shall include (at a minimum) pH, chlorine/chloramine, TOC, TDS, total suspended solids (TSS), turbidity, total alkalinity (including report of both p- and m- values), conductivity, total silica, total hardness, hydrogen sulfide, major metals including but not limited to: boron, iron, barium, manganese, strontium, copper and aluminum; major anions, including but not limited to: fluoride, chloride, phosphate, sulfate, carbonate, bicarbonate, sulfide, nitrate and bromide; and major cations including but not limited to: sodium, potassium, calcium, and magnesium. Silt Density Index (SDI) may be used for consideration of multimedia filtration. Excessive levels of biofouling contributors (e.g., sulfate reducing and iron related bacteria) shall be checked. The A/E shall determine appropriate safety factors for hardness and membrane fouling contaminants as part of the analysis of test data.
3. TOC composition of the water shall be tested and analyzed to ensure design TOC performance is achieved and is mandatory on water supplies sourced from surface water. Volatile organic compounds (VOCs) and trihalomethanes (THMs) levels should be reviewed. At minimum, verification of composition of TOC to ensure effective system performance must be

performed through consultation with the water purveyor with subsequent analysis of TOC test results to treatment method. The use of organic speciation via liquid chromatography/organic carbon detection coupled with VOC testing (LC/OCD) is strongly recommended to provide inexpensive and comprehensive TOC analysis prior to system design; however other scientifically recognized methods, including GC/MS and carbon column tests may be utilized.

4. Upon receipt of testing, the A/E shall perform the comprehensive water quality analysis and process calculations to establish treatment requirements, sizing etc. to achieve design in conformance with the DRM.

***Rationale:** In many cases feedwater characteristics can be subject to significant variation, including seasonal changes, source changes, and variations in upstream source water treatment. Testing for VOCs and THMs and low molecular weight organics is beneficial as such products typically pass through RO membranes (and some may require degasification). LC/OCD testing coupled with VOC testing, characterization of molecular weights can provide understanding of contaminants present and facilitate proper design.*

**B. Water Supply System Source:** Purified water shall be generated from a potable water source with a reduced pressure zone (RPZ) backflow preventer (dedicated ASSE 1013 [RPZ] local backflow protection). Local pressure boosting may be provided and shall be N + 1 redundant configuration.

**C. System Sizing:** The A/E shall define sizing parameters of the systems including total daily consumption, peak system flow, distribution flow to each floor or zone, maximum flow per outlet, supply to demand ratio (SDR), minimum and maximum pressures, minimum design Reynolds number (Re) under peak loop demand conditions and peak velocities. Each floor or zone shall be balanced in the field to provide a predetermined quantity of water flow so that all research functions are satisfied. The system production equipment and distribution mains shall be designed to incorporate a 20% overage for future demands or load compression.

**D. Storage Volume:** Usable storage volume serving purified water distribution systems shall be designed to provide 24 hour operating capacity. The use of multiple tanks (e.g., two tanks in parallel, each at 12 hours capacity) is acceptable where designed for equal usage, but is not required. Production equipment shall provide the total required capacity to replenish the system within 4 hours of operation. Where higher volumes of water storage are required or sufficient water turnover cannot be achieved, the use of ozonated water storage (with central UV destruct), hot storage, or similar means of maintaining water quality shall be provided.

**E. Tank Water Quality Preservation and Central Tanks:** Where replacement of tank water will not be achieved within a 24 hour period, a method of microbial control for the tank is required and turnover shall be incorporated to maintain water quality. The use of tank applied electrolytic ozonation with pre-distribution destruct may be considered, but is not required where other suitable methods are provided. Purified water tanks shall be placed as close as practical to the RO system and shall not be remotely located, except that remote located tanks may be considered on a project-specific basis where justified and provided with approved microbial control.

***Rationale:** Large storage tanks pose risk of water quality deterioration. However, a balance must be achieved to allow for service continuity such as an unplanned system malfunction. Remote located tanks may be desired for zoning but will typically require electrolytic ozonation with UV destruct. Local pumps and microfiltration to ensure water quality are rarely cost-effective.*

**F. Diversity Factors:** Unless otherwise directed, at least two use points shall be provided per wet lab (e.g., a polisher plus a sink tap), or one use point per module, as determined acceptable by the program management.

Diversity factors shall be appropriately applied by the design professional and documented. Total daily usage shall be considered in establishing loads in addition to peak demands.

**G. Flow-Rate:** Water supply to polishers and dispersal taps shall provide a demand flow rate of 1.5–2.0 L/min (0.4–0.5 gpm). Lab ware washers and other equipment



shall be sized based on individual equipment peak-flow-rate requirements, potential for simultaneous use, and projected daily throughput. Polisher demand shall include use and polisher system purge cycle demands over the 24 hour period.

**H. Supply to Demand Ratio (SDR):** Distribution system pumps and circulation systems shall be sized to provide a system SDR of at least 1.5:1. This requirement is prior to the 20% overage required for mains and risers and therefore it is acceptable to utilize a 1.7:1 SDR to accommodate sizing inclusive of overage for new mains.

*Rationale: Maintaining sufficient SDR and associated velocity requirements are key factors in maintaining system water quality and proper system hydraulics, including protection from backflow contamination.*

**I. System Location:** Source equipment shall be located in environmentally controlled, restricted access space subject to routine occupancy and shall not be located in boiler rooms, near oil storage tanks, pH treatment rooms, bedding disposal areas, sewage lift station or waste treatment or waste holding rooms or other potentially unclean spaces or areas subject to chemical vapors, damage, or tampering. Production equipment shall be located at the top of the system where possible.

**J. Temperature Control:** Seasonal temperatures, peak and minimum shall be investigated including municipal supply reports and installation site location and accommodated in design. For most systems at the NIH, feed-water thermostatic temperature mixing 25°C (77°F) shall be provided, except that cooler temperatures may be used for ozonated systems and small systems where the reduction in RO system efficiency is cost-effective. Cooling is required for all systems where the loop temperature may exceed 29°C (85°F) and to meet the ratings and manufacturers recommendations for proper operation of the RO membrane. Automatic purge is acceptable only for small systems where calculations show waste will be minimal. Permeate storage tank shall be located in conditioned space. Post-permeate heat exchangers shall be double-wall sanitary type, ASME code and ASME Bioprocessing Equipment Standard (BPE) compliant, designed for use with pure/ultra pure water of stainless, PFA, or PVDF. Supply feedwater heat exchangers shall be double wall NSF-61.

*Rationale: Temperature control is required to protect from overheating of systems, maintain RO efficiency, component pressure ratings, and other factors.*

**K. Media Bed Backwash and Startup Provisions:** Each individual deep media/resin bed, softener, and carbon unit shall be arranged with individual bypass valving, flush ports, and piping arrangements to facilitate flushing of particle fines, required regenerations, soak procedures, and other startup requirements as appropriate for media replacement or service exchange without damaging or disrupting system operation or passing particles to downstream components. Designs shall include sufficient freeboard and adequately sized supply arrangements for effective backwashing and shall not allow chlorinated water to reach the RO membrane. Backwash provisions may be omitted for service exchange systems, but individual soak provisions (for carbon beds), startup, and fines flushing arrangements are still required. Carbon bed backwash capacity shall be at least 490 lpm/m<sup>2</sup> (12 gpm/ft<sup>2</sup>) bed cross sectional area and drains shall be adequately sized for backwash (or surge tank discharge). Automation shall be provided for backwashing of large systems.

**L. Multimedia Beds/Sand or Similar Granular Media Deep Bed/Cartridge and Tangential Flow Prefiltration:** Provide multimedia beds or similar granular bed or sand filters only as required based on-site water supply conditions (typically surface water sources or other supplies with elevated TSS) or required by flow demand. Deep media beds shall be arranged to permit backwashing and provided with adequate water supply flow/size to facilitate backwashing, except where a service exchange type is approved, properly sized, and routinely replaced not to exceed 90 day intervals. On the Bethesda campus, multimedia beds are normally not required for potable water that has been filtered (centrally or locally) with 10–20 µm manual cartridge filters or automatic self-cleaning filtration (pretreatment filters shall be beta ratio 10 or better efficiency at the required particle and flux).

Multimedia beds are required where silt density index (SDI) is above 2.5 or turbidity is above 0.75 NTU (nephelometric turbidity unit) to minimize potential of RO membrane fouling and unacceptable filter load. Where SDI is below 5.0 and multimedia or similar deep

beds are utilized, a normally offline and dry cartridge filter may be utilized as a service bypass in lieu of providing two beds for  $N + 1$ . Multimedia beds shall be arranged upstream of the sorption (carbon/granular activated carbon [GAC]) such that chlorine residual will be maintained through the beds and prefilters, unless justified and conditional upon the provision of a suitable cleaning mechanism (e.g., high temperature potable hot water backwashing). All deep media beds shall be virgin material selected for application in high purity water pretreatment (typically anthracite/sand/garnet). Arrangements shall provide an operating face velocity of approximately 200–280 lpm/m<sup>2</sup> (5–7 gpm/ft<sup>2</sup>) of bed cross section, and at least two times the normal face velocity for backwashing and consistent with media manufacturer and AWWA B100. Feedwater flow rate metering is required.

Media shall be selected compliant with AWWA B100-09 or approved equal. Each unit shall be sized/selected for appropriate face velocity and volumetric flow rate (including consideration of resin channeling), capacity, pressure drop and (with the exception of service exchange type units) shall include sufficient freeboard (typically 50%) for bed expansion during backwash. Vessels shall be ASME fiberglass or ASME steel or stainless steel tanks provided with NSF-61 and FDA (food contact) compliant interior lining.

Galvanized steel interior coating and interior paint coatings are not acceptable. Vessels shall include provisions for media replacement. Dielectric waterways shall be provided between any copper piping and ferrous water softener connections. The use of hollow fiber (tangential flow) and ultrafiltration systems with 0.1 µm membranes may be used in lieu of deep beds where determined beneficial through life cycle cost analysis after thorough consideration of water quality, incoming TOC, and potential of biofouling.

Where multimedia beds are not provided, cartridge filters are required. Cartridge filters shall be arranged in parallel for  $N + 1$  redundancy.

**M.Scale Protection/Water Softeners:** Water softeners shall be provided wherever water contains a hardness level that may cause scaling with RO systems operated at a minimum of 75% recovery ratio of the first pass. Water softeners are typically required for applications at NIH Bethesda campus and shall be ion exchange, automatic alternating, demand volume-based (not

time-based) regenerating type, arranged to maintain service continuity as required for the process application. Anti-scalants shall not be used in lieu of water softeners. Brine tanks shall hold 3–4 weeks of salt demand, inclusive of a plastic salt storage shelf to maintain fresh brine. Brine tanks maintaining wet salt storage are unacceptable. A float safety valve and cover is required for brine tanks and a total hardness meter is required to confirm softening. The use of in-bed conductivity sensors are unacceptable. Membrane softeners and weak acid cation may be used where strong acid cation softeners are prohibited or not otherwise satisfied by use of potassium chloride and off-site regeneration may be used for small systems (e.g., consuming a single bed per month), or where required by local jurisdiction. Softeners using sodium shall not discharge to NIH facilities with on-site waste treatment or to dry wells. Partial salt recovery (recycling systems) shall be provided for large systems using sodium. Off-floor space for salt storage shall be included.

Where softeners are placed before the carbon bed, resin shall be rated for the chlorine/chloramines concentration of the water and suitably cross-linked. Resins shall be virgin, approved for use in potable water systems, shall be in conformance with NSF-61, and strong acid cation type, unless otherwise required. Maximum hardness leakage rates and maximum pressure drop shall be established to the application but in no case shall hardness leakage rates exceed 1% of the maximum influent total hardness.

Calculations shall be provided to demonstrate proper selection including sizing optimization for water and salt usage, bed volume flow rate, resin surface flow rate, capacity and pressure drop, control of resin channeling, and hardness leakage rate. The use of counter-flow and co-current operation shall be determined for the application to achieve optimum water and salt efficiency without exceeding required maximum hardness leakage.

Vessels shall be ASME polyethylene or polypropylene lined fiberglass or ASME steel tanks provided with NSF-61 compliant interior lining. Where placement is not otherwise avoidable in hot water systems, the equipment and resin selection shall be rated for operation at the maximum water temperature. Piping of softener skids shall be Schedule 80 PVC polypropylene with fused joints, or cement lined ductile iron.

***Rationale:** Water softeners are utilized in lieu of anti-scalants because they are more efficacious for the range of scaling compounds, avoidance of chemical additives, formulation and application variables, associated chemical handling (e.g., sulfuric acid and polymer type inhibitors), efficacy with varying pH, and overall reliability and stability of protection.*

**N. Automatic Membrane Cleaning/Membrane Fouling**

**Protection:** The use of direct osmosis high salinity (DO-HS) self-cleaning systems should be provided for all large/major systems and all systems where biofouling issues may be expected. Redundancy of equipment is not required.

**O. Pretreatment Train Microbial Control:** Residual disinfectant in the water system shall be maintained as late as possible in the pretreatment train. Activated adsorption units e.g., GAC beds shall be located as late in the pretreatment train as practical, and resin beds (e.g., softeners) shall be selected with chlorine resistant materials. Continuous circulation with 254 nm UV may be provided to help control effects of microbial growth in the pretreatment train and associated GAC beds and is required for any case where the GAC bed must be upstream of any deep media bed, softeners, or other components, or where extensive piping runs are required downstream of the GAC which be prone to excessive microbial contamination. Circulation of UV water through the pretreatment train shall not be relied upon as an exclusive method of microbial control but may be utilized with filtration on the feed water side of the RO membrane where beneficial. The distance between the activated carbon and the RO system shall be minimized.

**P. Chlorine/Chloramine/Oxidizer Removal, TOC Reduction/GAC:**

The use of GAC is required and shall be sized and designed in consideration of potential chloramines, in addition to organics reduction and chlorine removal. Oxidizing UV or reducing agents are not an acceptable substitution. Systems shall consist of at least two beds in series each with a minimum empty bed contact time (EBCT) of 5 minutes to achieve at least 10 minutes EBCT and chlorine levels below 0.05 ppm. Higher EBCT shall be provided for applications where required for specific TOC reduction. Where available pressure does not facilitate two beds in series, a single bed of not less than 7.5 minutes EBCT may be used

provided a sudden potential chlorine breakthrough incident would not be detrimental to the equipment or application and 50% breakthrough time has been evaluated. Minimum GAC depth shall not be less than 1.22 m (4 ft.) (and should be deeper, i.e., 1.52–1.83 m (5–6 ft.) where possible), and should include a 50% freeboard area for backwash. Although beds are provided in series, the backwash and servicing arrangements shall only take one unit offline at a time. Vessels shall be designed for flow of approximately 200 lpm/m<sup>2</sup> (5 gpm/ft<sup>2</sup>) of cross sectional bed area, but in no case above 30 lpm (8 gpm) or below 3.8 lpm (1 gpm) per square foot cross section. The design of the carbon bed and associated backwash velocities shall be in conformance with AWWA B604 and the recommendations of the carbon media manufacturer. Carbon bed backwash capacity shall be at least enough to achieve 30–40% bed expansion at backwash temperature but not less than 400–480 lpm/m<sup>2</sup> (10–12 gpm/ft<sup>2</sup>) bed cross sectional area. Service exchange systems shall not require changeout more frequently than quarterly. Vessels shall be ASME polyethylene or polypropylene lined fiberglass or ASME stainless steel tanks.

**Q. Carbon Selection:** GAC is required for RO pretreatment systems. Carbon shall be virgin material (including for service exchange systems), selected for the individual site water contaminant removal requirements, and be either re-agglomerated bituminous coal or control-quality coconut shell, low ash, without silver or other chemical impregnation, and 12 x 30 or 12 x 40 mesh size. Direct activated coal and lignite carbons are not acceptable. Certification to ANSI/NSF-61 and AWWA B604 is required. Trace Capacity Number (TCN or Acteoxime) shall be not less than 10 mg/cc; abrasion number shall be 75 or higher; apparent density shall be at least 0.45 g/cc, ash shall not exceed 10%. An iodine number of 950 mg/g or greater is required. An iodine number greater than 825 is acceptable where necessary due to organic fouling. An isotherm test, organic speciation, or other suitable design analysis shall be performed to confirm proper carbon selection and adequate EBCT and breakthrough duration. Where water supply contains chloramine, surface modified catalytic carbon without metal or alkali but otherwise compliant with the above including EBCT and adequate organics removal performance, may be used with two-pass RO provided an iodine number greater than 825. Service exchange systems shall be certified for tracability to potable water applications only.

***Rationale:** Reducing agents may promote RO biofouling, fail to treat organics, and promote byproducts. The use of properly selected GAC adsorption provides a robust treatment when coupled with RO to address a broad range of contaminants. Service exchange carbon of non-virgin origin may introduce contaminants.*

**R. Carbon Bed and Deep Media Bed Startup:** The carbon bed shall be pre-wetted for at least 24 hours. The placement and startup of the carbon sorption media shall be in accordance with AWWA B604. All backwashable systems shall be backwashed prior to installation. Lines shall be flushed prior to startup of downstream components.

**S. Chemical Additives:** Chemical additives other than required sanitants shall be avoided unless specifically justified by source water conditions and not otherwise avoidable by conventional treatment technologies. Only ANSI/NSF-60 listed products may be used. Chemicals shall be fully removed from the product water prior to distribution and the chemical supply and operating parameters shall be automatically monitored.

**T. Degasification/High CO<sub>2</sub> Levels:** Where degasification is required (e.g., CO<sub>2</sub> removal) membrane contactors shall be provided and located between the RO passes. For small systems, provision of pH adjustment only between passes (to pH 8 to 8.5) is acceptable for low alkalinity compatible water quality in lieu of membrane contactors where the system serves limited program areas and chemical adjustment is appropriately controlled to address seasonal incoming supply quality variations. The contactor housing shall be stainless steel or other compatible, non-contaminating construction compatible with water purity and pressure requirements, sanitary connections, and appropriate membrane pore size for carbon dioxide removal. Use a combination of filtered air sweep gas and vacuum from the compatible house system or vacuum or air as determined adequate for required levels of contaminant removal upon completion of sizing and application analysis. Controls shall be provided to prevent vacuum waste. Sweep gas control shall be provided as appropriate to throttle air usage during intermittent demand but not to create any condition which may compromise the membrane or performance. Building lab air shall be utilized for the sweep gas and shall be pressure controlled

and filtered at the unit. Where critical to water quality, redundancy of membranes (in parallel) shall be provided. Where application may be satisfied by locating the membrane either before or after the second RO, application between passes is preferred. The use of ion exchange beds in lieu of membrane contactors is not acceptable. Membrane degasification may also be provided where water supplies contain substantial THMs, VOCs, or requires use to achieve specified water quality.

***Rationale:** High CO<sub>2</sub> levels can promote algae and impacts pH and conductivity. Membrane contactors provides many advantages over forced draft degasification and chemicals. Application between passes allows for protection of water through RO from events (e.g., a membrane fiber failure). Ion exchange beds are not desirable due to ongoing microbial control issues, operational costs, and quality control.*

### 12.1.5.1 Materials Selection and Miscellaneous Component Criteria

**A. Storage Tank Materials and Construction:** Polypropylene or polypropylene lined fiberglass shall be used for tanks that are not ozonated, though natural linear high density polyethylene or natural linear PE-lined fiberglass may also be used for general applications that do not utilize ozone or incompatible disinfectants. Where ozone is utilized, purified water-storage tanks shall be PVDF lined (not coated) or 316 L stainless steel (with not to exceed 20 Ra electropolished surface finish and passivation). Use of stainless tanks requires review of life cycle cost, risk, and disruptions associated with routine maintenance, derouging, and re-passivation. Tanks that are pigmented shall have low TOC/extractable leach properties. Fluoropolymer tanks including but not limited to PVDF, PVDF or PFA lined fiberglass are also acceptable where cost-effective. Tank bottoms shall be conical and all tanks shall include hydrophobic vent filters. Plastic tanks shall at a minimum meet of 21 CFR 177.1520, be of sanitary construction, and where joints are required they shall be butt welded with smooth welds designed for high purity, crevice-free applications. Fillet welding and caps over welds shall be avoided. Tanks, including the design and construction of all access openings, shall be fully gas-tight and suitable for a working pressure of



at least 10.3 kPa (1.5 psig) at the maximum temperature of exposure; however not less than 38°C (100°F). Tanks shall be fully sealed except for the filtered atmospheric vent(s). Conventional screw-on tops larger than 150 mm (6 in.) diameter are not acceptable, however large flanged ports with a blank-off plate are acceptable. Elastomers for sealing any tank openings shall be in conformance with this section and openings shall be designed to preclude fouling.

**B. Storage Tank Fittings:** At a minimum, the tank level controls, rupture disk, fill line, discharge outlet, and vent ports shall be addressed in the location and quantity of nozzles. Nozzles/tank inlets shall enter the tank without protrusion beyond the inner tank wall and shall be crevice free. All piped connections shall be provided as sanitary (tri-clamp) style connections; although fusion joints may also be used where movement has been appropriately controlled. Flange joints shall be used only where tri-clamp or other sanitary options are not available. Where flange joints or rigid connections are utilized, a flexible connector consisting of a PTFE lined, smooth bore, non-corrugated stainless steel braided hose shall be provided to prevent shearing, leakage, or damage. Piping connections shall be braced to prevent stresses to tanks. Tanks with internal dip tubes shall include sufficient sanitary support to prevent tube breakage.

**C. Tank Support:** A corrosion-resistant durable tank support leg arrangement shall be provided with anchorage and shall be of a design approved by the tank manufacturer.

**D. Tank Level Sensors:** Tank level sensors shall be testable and adjustable without requiring drainage of the storage tank and shall be sanitary/hygienic type. Sensors shall be non-contact, liquid level pulse type radar, or high quality pressure type sensors; designed for high purity, low conductivity hygienic water conditions, non-contaminating, and with approved materials. Ultrasonic type sensors are unacceptable. Redundant high level sensors are required. Where tanks include spray balls, the level control shall be verified compatible.

*Rationale: The provision of redundant controls is to prevent rupture disk failure which can occur as level controls and fill valves lose adjustment or malfunction, and to provide alert to such conditions. Ultrasonic sensors are avoided due to sanitary, reliability, and tank shape/agitation issues.*

**E. Rupture Disks:** Each tank shall be provided with a low pressure sensitive, stainless steel, sanitary-type rupture disk of not less than 3 in. diameter and with a burst indicator in lieu of tank overflows. The rupture disk shall be piped to drain with an air gap. The maximum pressure rating utilized for the selection of the rupture disk shall not exceed 70% of the tank rated working pressure and shall be at least 14 w.g. The effect of any back-pressure that may be present in system vents/filters shall be considered. Rupture disks shall be selected to activate both for liquid and vapor conditions. Each tank shall be specified with a suitably sized overflow port to receive the rupture disk (typically a 100 mm [4 in.] overflow port, but not less than 75 mm [3 in.]) adapted to receive a tri-clamp connection serving the rupture disk and associated burst indicator. Provision of a torque nut is required and the burst indicator shall provide an alarm condition to the system PLC. Where the tank is subject to vacuum conditions, an appropriate sanitary relief arrangement, vacuum rupture disk, or dual acting disk shall be provided. Chemical traps and p-traps with or without checks are unacceptable.

*Rationale: Overflow designs are often not as tight as vent filters and are susceptible to microbial fouling or chemical contamination. Overflowing traps waste purified water. Proper disk sizing and selection is critical to avoid false activations.*

**F. Spray Balls and Dip Tubes:** Spray balls above the water line are required for multiple pressure zones. For single pressure zone systems, the use of properly sized spray balls shall be used for non-ozonated systems. Ozonated single pressure zone systems shall utilize below water line dip tubes or dip tubes with a side stream loop. Spray ball pattern shall ensure complete coverage without spraying into/blocking hydrophobic vent filters.

**G. Vent Filter:** System openings shall be filtered to protect from contamination, and provision of a filtered vent is required to maintain tank atmospheric pressure. Vent filters shall be hydrophobic type, 0.2 micron rated per ASTM 838-05 with a 0.2 µm sterilizing grade performance in liquids, 0.003 µm in dry gas, 100% integrity tested and mounted in a dead-leg-free sanitary housing with double O-ring seals. Vent filters shall provide at least a 6 month service life. Coordinate the vent filter selection with rupture disk selection to prevent disk bursting

due to sudden changes in tank level as associated with system operation. Sizing shall be sufficient to ensure that the maximum pressure or vacuum in the tank does not come within 80% of the working rating of the rupture disk; the flow rate shall include a safety factor three times over the maximum combined pump out and fill rate. The filter shall meet flow rate requirements not to exceed 1.49 kPa (6 in. w.g.) pressure differential, including vent back-pressure. The maximum pump-out rate shall include the increase in pump speed/pumps in operation as applicable to system flushing and sanitization. Vents/filter housing shall be heat traced where required to prevent blockage; at a minimum, mount the vent filter near to the tank with self-draining piping.

**H. Cartridge Filters:** Filter housings and components shall be rated at a minimum of 1,034 kPa (150 psi) working pressure and shall be selected for flux rates, element replacement frequency, maximum loaded pressure drop, and shall be constructed of type 316 L stainless steel. Polypropylene filter elements may be used in the pretreatment train (not where subject to ozonation). Housings in product water shall be sanitary type, electropolished, interior, and with no dead-legs. Filter elements shall at a minimum be approved for use with potable water. Filters on the downstream side of the activated carbon shall be free of binders, adhesives, of compatible materials and elastomers, and 21 CFR compliant for food contact. String-wound filters are not acceptable for the RO prefilter or other critical filters. Suitable filter media is generally polypropylene and PES for non-ozonated applications and PVDF or PTFE for all applications including ozone. The required filter performance and beta ratio, efficiency, or rating method shall be specified. Flush ports are required except for final filters and vent filters. All filter housings for liquid systems shall include a drain to prevent contamination during filter element changes and a high point air vent (both on the dirty side). Housings shall be non-proprietary to a single manufacturer's elements. Additionally:

1. Filters shall be arranged in parallel to provide  $N + 1$  capacity. Filters shall include means for independent isolation and pressure monitoring (manual type/pressure gauges) are acceptable. Pressure gauges are not provided on vent filters. Isolation valves on vent filters shall be provided with a locking device and position indicator, and locked open.

2. Filter ends shall be O-ring type seals. A single O-ring is acceptable for pretreatment, double O-ring is required for the permeate side of the RO system and critical applications. Flat gasket, crush-seal, and knife-edge seal arrangements are unacceptable. Seal designs shall be Type 222 or 226 style, with or without fin as required, and shall be Code 2, 3, 7, or 8 style as appropriate.
3. Filters selections shall not require pre-wetting.
4. System pre-filters utilized for the pre-treatment train shall be rated 10 to 20  $\mu\text{m}$  at Beta 10 unless deep media beds are utilized. Divert to drain flush ports and dead-leg free sanitary drain valves shall be provided.
5. RO membrane pre-filters shall be rated either 5 $\mu\text{m}$  at Beta ratio 5,000 or 1 $\mu\text{m}$  at Beta 10 unless justified by feedwater analysis. Resin traps or additional pre-filters may be provided ahead, but shall be included only where necessary.
6. Final particle filters (microfiltration) shall be provided after the storage tank(s) but prior to distribution, downstream of system UV equipment, as part of the circulation loop. The filters shall be ultrapure water (UPW) hydrophilic PTFE or PVDF single or double layer membrane type with no wetting requirements, non-shedding, with single digit ppb TOC extractables, rated for an efficiency of greater than or equal to 90% at 0.1 $\mu\text{m}$  when tested per SEMI 5067A polystyrene ball test or per SEMI C079 validation standard or at 0.02  $\mu\text{m}$  (20 nm) per SEMI C079 validation standard or an equivalent test method with filters of at least this efficiency. Filters shall be 100% integrity tested. Housings shall be sanitary type and utilize multi-element housings as required.
7. Filters shall be selected with sufficient surface area for a 3 month replacement cycle with a pressure drop not to exceed 69 kPa (10 psi); final filters shall not require replacement more frequently than annually and vent filters semi-annually.



**I. Service Exchange Resins/Media:** Typically, service exchange is only acceptable for applications serving small systems where permanent vessels would not be justified. Service exchange frequency for pretreatment bed materials (including GAC and media beds) shall require a frequency of not more than a quarterly basis. Resin change out shall be based upon breakthrough/performance data provided microbial control may be maintained. Where service exchange is intended to be applied for large systems and critical applications, a comprehensive cost analysis should be performed and sufficient control of the media/vessel performance characteristics shall be demonstrated.

*Rationale: A key issue with service exchange is control of contaminants, media performance, and potential of variations associated with different vendors.*

**J. UV Systems, General Requirements:** UV systems shall be 316 stainless steel chamber, less than or equal to 20 Ra, low pressure type. Systems shall include digital intensity meters and a “lamp out” indicator, sanitary connections, and stainless steel light traps shall be provided. UV control shall alarm to the system monitor and include an automatic safety cut-off to protect from no-flow and high temperature conditions. Capacity shall be within manufacturers approved flow ratings. Certified bulbs (validated lamps) are required for TOC oxidation and ozone destruct applications and the intensity sensor for these applications shall be traceable to NIST. Adequate turbulence within the UV chamber shall be verified with the manufacturer for all oxidizing applications, including O<sub>3</sub> destruct. Calculations/manufacturer substantiation shall be provided to demonstrate proper UV sizing, fluence, UV transmission (end of lamp life calculation), conformance with manufacturer flow and turbulence, bulb-distance requirements, and heat gain. Minimize or avoid baffles where possible. N + 1 online equipment is required; bypasses shall not be provided.

**K. UV Disinfection Systems:** UV systems for disinfection shall be provided prior to distribution in the circulating loop, upstream of the final particulate filter and shall be rated at 254 nm. 254 nm UV for disinfection purposes is not required where oxidizing UV has been provided at the same location, however this does not waive requirements for 254 nm UV for ozone destruct

where ozonation is utilized. UV for disinfection is also not required where 254 nm UV for ozone destruct is provided at the same point. Minimum fluence shall not be less than 30 millijoule per square centimeter (mJ/cm<sup>2</sup>) at end of lamp life (greater than or equal to 60 mJ/cm<sup>2</sup> new lamp).

**L. Oxidizing UV:** 185 nm UV shall be provided for polishing oxidation of organics where required to maintain specified product water TOC limits. Oxidizing UV shall be used for TOC polishing only, not for primary reduction. Provide N + 1 redundancy (in parallel) and locate downstream of the permeate tank(s) prior to the final filters. Fluence for specific water conditions shall be demonstrated and at least 300 mJ/cm<sup>2</sup> is required (usually greater). Coordinate the arrangement with other provision of membrane degasification, or (where deionization is unavoidable) with provision of EDI to address conductivity issues. The A/E shall evaluate potential of unacceptable byproducts of oxidation as may be associated with UV or upstream ozone (e.g., hydroxyl radical/hydrogen peroxide formation, various acids etc.) depending on feedwater organics. Catalytic conversion may be used as required and a sample port shall be provided where hazardous carryover is plausible with subsequent confirmation of no hazardous byproducts.

**M. UV Ozone Destruct:** At least three UV ozone destruct systems (254 nm) are required, two of which must be online, in series, and operational to serve the entire flow at any time. Automatic alternating rotation of the offline unit (power status) shall be provided and a critical alarm shall occur if two of the three required units are malfunctioning. A bypass shall be provided around individual units for maintenance while maintaining at least two units online, in series. Arrangements shall preclude dead-legs and be fully drainable when bypasses are not in use. Piping configurations shall not rely on repeated wetting/drainage/drying due to leakage potential of seals. The minimum UV fluence for ozone destruct (per destruct unit) shall be at least 125 mJ/cm<sup>2</sup> at end of lamp life for typical ozone levels below 1.0 ppm. Frequency of sanitizations (on/off switching) shall be evaluated in equipment selection for EOL calculation. Any failure condition that does not maintain two ozone destruct units in series and in operation (including lamp outage) shall automatically shutdown ozonation. UV systems for ozone destruct shall be specifically designed for that purpose and elastomers shall be FKM.

**Rationale:** *In-series UV ozone destruct is required to ensure complete destruction of O<sub>3</sub> that may leak past a UV unit. In the case of the ozone destruct, redundancy of the UV is considered a safety component. Oxidizing TOC is not acceptable as a primary method due to efficacy and potential of toxic byproducts.*

**N. Pressurization/Distribution Pumps:** Pumps shall be arranged as N + 1 and configured to provide operational redundancy normally online and without stagnancy. Individual VFDs shall be provided for each pump. In the event of a pump failure, the remaining pumps shall ramp up automatically to maintain the normal system flow. For small systems or limited program areas where the use of individual VFDs are impractical, it is acceptable to provide constant speed operation with each pump sized at 50 to 60% load, provided the flow rate at 50% load is sufficient to maintain the required minimum velocity throughout the entire system under conditions of failure of any pump, and provided such pump failure is automatically monitored. Pumps downstream of the RO membrane shall be hygienic (sanitary) 3A or EHEDG centrifugal type, designed for WFI, UPW, or high purity applications, free of dead zones and of clean in place (CIP) design, AISI 316 L or 329 L stainless steel 20 Ra and electropolished, or sanitary fluoropolymer lined (not coated) construction. Pumps shall be provided with silicon carbide seals designed for use with low conductivity UPW, and shall include a seal flush configured per manufacturer recommendations to maintain sanitation, service life and control noise, or alternatively shall be magnetic drive (seal-less) sanitary type. Motors shall be wash down duty or TEFC. Connections to pumps shall be sanitary TC. Controls/power supplies shall be arranged to permit elevated velocities (above 1.52 m/s [5 fps]) to be achieved in the piping system for periodic chemical sanitization and rinsing. Special application purified water systems (e.g., applications purified for scale control only) may utilize conventional 316 L centrifugal pumps provided microbial control is not required.

**O. Check Valves:** Check valves shall be avoided if possible. Where required, they shall be of sanitary type only, typically a ball check.

**Rationale:** *Crevices and fouling areas are associated with check valves and should therefore only be used where absolutely needed. Effective system design, pressure control, and hydraulic modeling can often be used to minimize check valve requirements.*

**P. Lab Water System Service Continuity:** Systems shall be arranged to maintain service continuity and to ensure that upon plausible failure conditions, including loss of power and routine maintenance that entire circulation systems remains in safe operation. A redundant controller, backup controller, or at least readily available program backup for a non-proprietary controller, with non-volatile memory shall be specified. N + 1 redundancy is required for equipment downstream of the permeate tank to facilitate continued system operation and prevent contamination during routine maintenance.

**Q. RO Systems, General Requirements:** Two-pass systems are required for RO feedwater systems serving labs. Single pass RO may be used only for scale control, point of use supply or supply to stills, and low purity applications. The second-pass concentrate shall be recycled back to the first-pass feedwater (with softening only where required). Optimal recovery for each pass shall be as determined through system analysis (typically approximately 75% first and second pass at Bethesda). In performing system design, the A/E shall consider the impact of reduced performance up to the anticipated replacement/service point of the membrane (typically approximately 10% reduction). The use of RO process design software is required for membrane selection, configuration, and array optimization to individual project water conditions and arrangement of treatment components. Additionally, a fouling-factor modified performance calculation shall be submitted to demonstrate performance at 3 years of membrane age. Recovery per element should not exceed 10%. Waste/reject lines from RO components shall not be combined.

**Rationale:** *Required resistivity, TOC and microbial requirements will generally not be met or maintained with a single-pass system; and two-pass provides consistent, low maintenance, reliable water quality.*

**R. RO Membrane Selection:** Membranes shall be thin film composite/polyamide flat sheet and spiral wound type. Membrane selection shall provide required rejection of ionic and organic contaminants in consideration of the on-site water supply analysis, but at least 98% for ionic contaminants and organics above 200 daltons. The use of anti-microbial chemical impregnated RO systems (e.g., silver impregnated spacers) is unacceptable. Extra high rejection membranes and performance with low molecular weight organics shall be reviewed as applicable to on-site water contaminants.

*Rationale: Thin film composite (TFC) polyamide (PA) membranes are preferred for their pH stability and TOC reduction performance, along with their resistance to microbial degeneration susceptibility from low chlorine.*

**S. RO System Instrumentation and Controls:** RO systems shall include instrumentation and controls for monitoring feed pressure, permeate pressure, inter-stage pressure, concentrate pressure, online resistivity (or conductivity) for both feedwater and permeate, feed temperature, flow metering for feedwater, permeate and concentrate, totalizing for feed water and permeate, temperature and pressure monitoring and control and protection, and an adjustable reject flow-rate-control valve (including control for second pass reuse). Automated monitoring of membrane rejection and permeate flow percentage is recommended, and set point shall be specified (typically 90%). Components shall be of a non-contaminating type. Automation shall be provided for parameters necessary to protect from system damage (e.g., low feed pressure, high temperature etc.), with fault alarm to the system PLC and general or critical fault to BAS. Automatic restart shall be provided for RO system features (e.g., low pressure) to minimize intervention, however fault conditions shall be recorded. For any application where chemicals are permitted, automatic monitoring (e.g., metering, ORP, pH, etc.) shall be provided.

**T. RO System Materials of Construction:** Pressure vessels (membrane housings) shall be ASME code compliant and NSF-61 (or equal). Minimum vessel pressure rating shall be 2,070 kPa (300 psi) except that vessels 102 mm (4 in.) and larger shall be at least 3,105 kPa (450 psi). Vessels shall be epoxy coated fiberglass or 316 L stainless steel and shall be ASME Section

X code stamped for greater than or equal to 4,140 kPa (600 psi) vessels. PVC vessels may be used only for point of use/small local applications not directly exposed to UV light, and provided such applications operate below 1,030 kPa (150 psi) (within the vessel). Housings shall not be proprietary to one manufacturer's membranes. Fiberglass or fiberglass lined stainless is required where direct osmosis high salinity (DO-HS) is employed. The selected membrane and housing (including fiberglass resins, surface finish, seal designs, ports, and elastomers) shall be designed for use with ultrapure or pharmaceutical water applications and shall be selected for low particle, microbial, and TOC elution. Multiporting is not permitted unless the design arrangement and performance has been confirmed by the membrane manufacturer. Split ring pressure vessel closures are unacceptable. Pumps shall be 316 L stainless steel, with stainless steel impellers and non-leaching compatible elastomers suitable for the clean in place (CIP) method. The use of brass valves, solvent cement, PVC components and hoses, and other materials which are susceptible to leaching contaminants or high maintenance are unacceptable. 316 L stainless steel is required for all RO system piping and tubing including high pressure waste. All instrumentation shall be process/industrial grade. Electrical arrangements shall be listed in conformance with requirements of a nationally recognized testing laboratory, and all wiring shall be in conduit. Motors shall be totally enclosed or wash down duty.

**U. RO System Clean in Place Configuration and Special Access:** Systems shall be configured to facilitate an approved CIP configuration, utilizing chemical sanitization unless other approved methods are utilized. The use of DO-HS membrane cleaning systems is generally recommended and shall be provided for all large, central systems, especially where influent water quality exhibits potential membrane fouling characteristics. Placement of the RO system shall allow for replacement of RO membranes.

**V. General Material and Connection Requirements:**

1. Piping materials in the pretreatment train shall be either pigmented polypropylene of IR, butt, or socket fusion, materials as approved for use in the purified water distribution system, or on the upstream side of the GAC, may also be Schedule 80 PVC with two step solvent cement and not

less than a 24 hour cure time. Downstream of the RO membrane, materials shall be as approved for purified water distribution, refer to [Chapter 6](#).

2. Hoses in the pretreatment may be used for final connections up to 1.2 m (4 ft.) long where 21 CFR 177.2600 compliant, suitable for maximum pressure, and of fluorocarbon lined smooth bore construction with stainless steel braid as required. Fittings shall be 316 L stainless radial crimped type, with either rigid, flared, flanged, or sanitary connections. Push-on style joints and PVC or rubber hoses are unacceptable.
3. All connections downstream of the RO system shall be sanitary type. Unions, flanges, and compression joints are unacceptable. Tri-clamps shall be 316 L stainless steel with approved elastomers and in conformance with the current ASME BPE standard. Provide a manufacturer-approved torque nut for the application and gasket material or other assurance of application of only proper torque. The use of tri-clamp connections is only permitted for instrumentation, orifice plates/flow restrictor tubes, and equipment connections provided the connection is readily accessible.

## 12.1.6 Distribution Systems: Common Requirements

**A. Constantly Circulating System:** All systems shall be designed as constantly circulating back through the tank, UV and final filter, with appropriate considerations to control microbial contamination, regardless of required water quality.

**B. Distribution Piping System Sizing:** Distribution piping systems, including mains and risers shall be sized to accommodate the current load plus 20%, in addition to required minimum SDR specified in this section. Systems must be designed to perform within required velocity limitations under these 20% overage conditions. The distribution piping shall allow for at least two usage points per lab (one polisher and one sink outlet or other common allowance e.g., 1.5–2 usage points per lab module as required by the PO). The minimum SDR shall be achieved under these allowances without exceeding allowable velocities or pressure. Diversity

shall be applied to sizing mains and equipment.

**C. Operating Velocity:** A minimum velocity corresponding with turbulence Reynolds number of at least 10,000 or a velocity of at least 0.30 m/s (1 fps) is required throughout the system (including returns) under all conditions, including peak design demand. Normal operating velocities in excess of 1.52 m/s (5 fps) are generally not acceptable for plastic systems. Stainless steel distribution systems shall provide a velocity of at least 0.61 m/s (2 fps) under normal conditions regardless of application.

**D. Periodic Flushing Velocity:** Systems shall be capable of achieving elevated velocities for systems flushing of 0.91–1.83 m/s (3–6 fps) for PVDF, polypropylene and other plastic materials, and between 0.91–2.44 m/s (3–8 fps) for stainless steel piping.

*Rationale: These velocities are adequate for DRM compliant systems. Elevated velocity is provided for stainless steel to maintain corrosion resistance. Capability to increased velocities for sanitization and flushing can be beneficial for removing and exposing biofilm to chemical sanitants, and to assist in rapid rinsing.*

**E. Pumps/Water Exchange:** Pumps shall be arranged to prevent dead zones and stagnancy. No pump (including on the feedwater side), shall be operated at intervals that are less frequent than every 12 hours, and pumps within the distribution system shall operate continuously.

**F. Pressure Requirements:** A residual pressure of not less than 207 kPa (30 psi) shall be provided at the hydraulically remote use point; however where this would result in unavoidable additional pressure zones it is acceptable to provide a minimum residual pressure of 140 kPa (20 psi). Maximum pressure shall not exceed 550 kPa (80 psi), except that static pressure up to 690 kPa (100 psi) will be permitted within the distribution system where maximum pressures are compatible with all components. Unless justified, 140 kPa (20 psi) shall also be the minimum pressure of any point in the pressurized distribution system including during peak demand. Pressure requirements at the polisher, lab equipment, and tank spray ball shall be verified, with the system capable of delivering the more demanding criteria. Unless pressure higher than 140–207 kPa (20–30 psig) is required, the 207 kPa (30 psi) values shall represent the baseline for the hydraulically remote points of the system.



**Rationale:** Supply loop pressure must not drop below 140 kPa (20 psig) at any point in the system to protect systems from backflow and ensure acceptable operation of components wherever they connect to the system. The use of 207 kPa (30 psig) as the lowest pressure at use points is for flexibility to accommodate equipment of various types and manufacturer. Spray balls typically require greater than or equal to approximately 172 kPa (25 psig).

**G. Use of Pressure-reducing Valves:** Pressure-reducing valve (PRV) use shall be minimized and shall not be located throughout the system or at points of use in lieu of multifloor pressure zoning. PRVs shall be provided only at the final point of connection to polishers and equipment where required by the equipment manufacturer, pressure condition within the relevant pressure zone(s), and provided the resultant dead-leg has been adequately addressed. Such PRVs shall be located on the downstream side of the equipment isolation valve.

**Rationale:** PRVs can create maintenance issues, can induce particles, and promote microbial contamination, especially where not in a constant open, flowing condition.

**H. Multiple Pressure Zones:** Pressure zoning shall be accomplished by use of independent distribution pumps and associated independent loops back to the storage tank for each individual pressure zone or by use of a single sanitary type PRV to serve the supply main just prior to feeding the entire zone(s) requiring reduction. The return for each low pressure zone(s) shall be provided with independent duplex in parallel in-line pressure boosting (if boosting is required) to maintain at least 140 kPa (20 psig) in the system return back to the tank, located at a point downstream of the last return connection within each pressure zone. Each return shall be piped independently to an air break within the storage tank above the high water line such that PRV's remain open and flowing. PRVs shall not be arranged in series. Alternatively, each pressure zone shall be fitted with an independent supply and return loop with its own dedicated distribution pumps, tank, and microfiltration provided each tank is near to the RO system. The use of downfeed arrangements (e.g., supply tank at the top of the system) shall be used where possible whenever multiple pressure zone

arrangements are required. Pressure booster pumps serving the return for the low pressure zone(s) shall be located in an accessible mechanical space.

**Rationale:** Downfeed arrangements minimize pressure on front-end equipment, the risk of flooding during maintenance, and can reduce piping costs.

**I. Combination of Returns:** Returns from separate building wings and pressure zones are preferably returned separately to dedicated ports at the storage tank. However if sufficient tank ports are unavailable (or where required as part of ozonated systems), combination of returns from individual pressure zones or building wings that are supplied by common distribution pumps may occur immediately at the storage tank connection but downstream of individual back pressure regulators serving each individual zone or building wing. A separate shut-off valve is required for each individual return main at the point of interconnection. For returns from separate building wings supplied from common distribution pumps, the use of a below water line dip tube return is acceptable for ozonated tank applications only where each return is from the same pressure zone. Where preclusion of reverse flow cannot be assured, a separate return for each pressure zone to the tank above the high water line is required. Pressure sustaining devices, return loops, and on-floor distribution shall not be subject to potential reverse flow and the use of check valves or other control valves are unacceptable.

**Rationale:** PRVs applied to sections that return above the high water line simulate an open, constant demand system condition; however, PRVs still contain fouling areas and should be avoided where possible.

**J. Circulation through PRVs and Multiple Pressure Zones:** Forced circulation shall not occur through PRVs in any closed loop configuration. Once pressure is reduced, it shall not be blended back into a higher pressure system. PRVs shall be arranged only in a manner where constant flow at required velocity is maintained without backpressure. The use of orifice plates, flow control valves, check valves, remote sensing controls and other attempts to compensate are unacceptable.

**K. Hydraulic Shock and Surge Pressures:** Maximum surge pressures, hydraulic shock etc. shall be addressed to prevent exceeding working ratings of materials. The use of shock arrestors, bladder tanks, or other arrangements that may result in microbial contamination is unacceptable.

**L. Pressure Sustaining/Pressure Control Devices:** Pressure sustaining/back-pressure regulator valves shall be provided at the end of return (or at the end of supply/supply to return bypass) of all systems to maintain adequate pressure control under varying demand conditions and shall be applied individually for each pressure zone. Pressure control devices shall be non-contaminating, sanitary high purity diaphragm type, designed for UHP system applications, free of dead zones and with approved elastomers and wetted materials, and matched to load conditions to ensure adequate opening. External sensing, automatically modulating type pneumatic actuated radial (weirless) diaphragm valves shall be used as the pressure sustaining/control device for large systems, and shall be air-to-open, fail closed (spring type) configuration, operated by an upstream pressure element through a current to pneumatic (I/P) converter. A pressure relief valve is required on the air supply between the I/P converter and the back pressure regulator. Conventional self-contained UHP water diaphragm backpressure regulators shall be used only where adequate capacity match can be achieved to the low flow return condition (e.g., peak demand/low back pressure) to preclude cavitation, and subject to provision of sufficient downstream back-pressure (e.g., a tank sprayball) for proper operation. The required set points for all pressure control devices shall be properly documented and verified at project startup including under peak design demand condition with confirmation of required minimum pressure in the system. Where end or return pressure sustaining is used, inclusion of a sufficiently sized zero static valve on the main return upstream of each back pressure control valve is recommended to facilitate startup.

**M. Supply and Return Pressure Control and Differential:** Provide sufficient pressure control and any required differential between the supply and return mains to minimize potential for backflow and ensure proper flow through the distribution system and branches under all demand conditions. This shall be accomplished through proper use of flow control tubes or orifices, (or in some cases may be accomplished with reduced size diaphragm type valves to affect control) at the end of each supply

(beginning of each return). Care shall be exercised in the sizing of returns and balancing valves and flow restrictors to prevent oversizing and maintain required control within the limits of the balancing device (diaphragm valve) or flow restrictor orifice. Where return lines from recirculating outlets are connected to a serpentine supply arrangement, the return shall have a positive maintained pressure differential below the supply. PRVs shall not be used for this purpose.

*Rationale: Inadequate pressure differential can result in backflow and unstable operation of the distribution loop.*

**N. Dead-Legs and Circulation:** Dead-legs in distribution and return piping shall in no case exceed 4 pipe diameters in length. Where possible, dead-legs shall be eliminated and comply with ASME BPE standards. The use of zero-static valve arrangements are typically required. All pipe line branches and run-outs shall be circulated.

**O. Hygienic Design and Surface Finish of Components:** Systems components shall be selected with surface finish per the selected water quality. Crevices and pockets shall be avoided and systems shall be constructed as sanitary (hygienic) type following best practices. Stainless steel component surface finish (after the RO) shall be at least 20 Ra and electropolished.

*Rationale: These provisions help maintain water quality and facilitate effective sanitization, rinsing, and corrosion resistance.*

**P. Extensions/Modifications to Existing Systems:** Where existing systems are extended to serve additional points, ensure the SDR allowed for that floor, wing and area do not drop below 1.5:1. Where demand may cause such a drop, upgrades to supply may be required and shall be indicated to the PO.

**Q. Future Tap Provisions/Flexibility:** Circulated taps with valving in the normally open position to maintain circulation shall be provided at points for anticipated future expansion (including where unused extension of risers or mains are provided). Such taps shall be arranged to preclude need to cut into or relocate piping for future connections. A valved supply and return connection (with flow control) and continuous circulation shall be provided for each research wet lab, even if



current lab usage does not require purified water. The requirement does not apply to specialized areas where there would be no plausible need for purified water in the future. Distribution systems and flow controls for unused branches and for serving supply and returns shall be sized to maintain required loop flow based upon the condition required once the full demand for that floor or wing has been built out. The initial system shall maintain the required minimum loop return flow inclusive of all circulated taps.

The preferred method is through use of a zero-static diaphragm (T-valve) on the supply and return mains with sanitary tri-clamp outlets between an engineered orifice inserted on the lab (or future outlet) side of the return system valve with the branches interconnecting and open for flow.

The use of normally closed zero-static diaphragm valves (T-valves) on both the supply and return mains, each with branch lines capped for future may also be used to serve each individual lab, provided required future flow restrictor size has been identified. Where this approach is used, supplies and returns must still be sized for the future demand, the end of the supply main must have an accessible and resizable (replaceable) flow restrictor and associated valving, and a hydraulic model must demonstrate proper performance for each (initial and future) condition.

***Rationale:** These requirements are to ensure accommodation for future connection points without dead-legs or need to cut into the system, and to ensure required system flow is properly maintained. The sanitary tri-clamps permit the change out of the orifice plate and the extension of the piping downstream of the isolation valves into the lab or future program area.*

**R. Distribution Arrangements, Supply and Returns:** Reverse return and direct return horizontal distribution arrangements consisting of a supply and return branch takeoff from the horizontal supply and return main to serve each laboratory shall be provided as the required systems distribution approach. The distribution design shall allow for each individual lab to be isolated by operation of a single supply and return valve. The supply and return mains shall be connected to a dedicated common supply and return riser back to the source equipment.

**Exceptions:**

1. *The use of serpentine distribution between outlets is acceptable but shall be limited to distribution within only a single lab, fed from the common supply main serving that lab. The end of the serpentine supply for that lab shall connect back to the dedicated direct or reverse return main. Bypasses are not permitted.*
2. *The use of single floor serpentine arrangements may be accepted on a project specific basis for small facilities or where extensions must be made to existing systems originally constructed in this manner. Such systems shall be arranged such that the serpentine arrangement serves only (at most) a single floor within a single laboratory wing prior to connecting to dedicated main supply and return risers, and not serpentering from one floor to the next. Separate distribution loops shall be provided to serve labs on each side of the corridor such that labs on each side are independently operational. The use of bypass valves in serpentine loops (e.g., attempts to facilitate individual lab or outlet isolation) is unacceptable. Circulation shall be maintained at all times through the entire system, without dead-legs. Isolation valves are required at the beginning and end of each distribution loop.*
3. *Special system applications not serving labs, and therefore not susceptible to potential changes in outlet quantities or locations (e.g., RO for descaling functions) and other limited applications as approved may utilize serpentine systems.*

***Rationale:** Although serpentine loops provide positive circulation and are simple design, such arrangements are not flexible for changes, repairs, or renovations without disruption and potential significant maintenance costs. Bypass arrangements provide dead-legs, which in room temperature systems should not be present. Properly engineered direct and reverse-return approaches with horizontal mains allow for individual lab shutdown without disrupting other areas, facilitate reduced branch pipe sizing, avoid dead-legs and maximize future flexibility. The use of reverse return branches to laboratories may be coupled with direct-return mains/risers for additional system economies.*

**S. Piping System Distribution Independence:** The piping system distribution on each floor and building wing shall be independent of other floors to the connection with the main supply and return riser.

*Rationale: Independent designs of floor loops minimize disruption as systems are maintained, cleaned, or modified and ensure effective circulation.*

**T. Single Pipe Distribution, In-Line Flow Restrictor Systems:** The use of single horizontal supply pipe distribution systems with in-line flow restrictors (and without a dedicated horizontal return main for each floor) may be used for small facilities, lease facilities, and conversions of existing serpentine systems (e.g., to facilitate independent lab isolation capability), subject to the following:

1. Each horizontal main shall serve only outlets on a single floor, fed from a supply riser and circulating back to an end-of-line dedicated return riser. A total of two floors, with not more than 40 outlets per floor, may be served by such systems, provided the result is not more than 10 flow restrictors in series throughout the system, and provided required velocities, flows, and pressure requirements are maintained throughout the system.
2. A separate zero-static diaphragm T-valve and in-line flow restrictor (or similar manufactured assembly using zero-static valves) shall be provided to serve each lab, and engineered for the number of outlets served. Capacity shall be as programmed, but at minimum such systems shall be engineered to provide for at least three use point outlets and a total demand flow of at least 6.62 lpm (1.75 gpm), plus required recirculation rate to maintain a flow velocity of at least 0.30 m/s (1 fps) under peak demand, per lab. The in-line flow restrictor shall be either an engineered orifice plate of PVDF or 316 stainless steel, or shall be an engineered PFA restrictor tube. Adjustable valves are not permitted. Each in-line flow restrictor shall be accessible and provide sanitary tri-clamp connections. Where multiple mains utilize such an arrangement (e.g., two floors), hydraulic modeling is

required to demonstrate required flow, pressure, and velocity under all demand conditions and conditions of varying branch lines open/closed status, e.g., up to all labs on an entire floor being shut-off. Each wet lab (or future wet lab) shall be provided with the tee/valve/orifice arrangement, and a loop shall be provided to maintain proper flow without a dead-leg. Within an individual lab served by zero static valves, flow restrictor/tee arrangements may be used without requiring zero static valves, however conventional diaphragm valves are still required at use points.

3. The use of flexible sanitary tubing and fittings constructed only of PFA will be permitted in lieu of piping provided the tubing and joints are fully accessible, only used on the downstream side of isolation valves for individual labs, joints are minimized and the tubing shall be opaque jacketed. PFA tubing joints shall be sanitary heat-fused or sanitary heat flare. Use of multiple supply mains or return risers per building wing to exceed the system size limitations is not acceptable.

**U. Dispensing Outlets:** All outlets, including sampling ports shall be oriented for discharge to drain dry when not dispensing water.

**V. Connector Hoses:** Sanitary heat-flare type polyethylene (for polypropylene systems) or PFA (for PVDF or polypropylene systems) tubing of type and pressure rating compatible with system water quality shall be used for final faucet and point of use equipment connections that are not hard piped, provided the hose and connections are constantly circulating. Alternatively, braided, non-corrugated PTFE connectors with flare or sanitary ends may be utilized. Hoses shall be of size to ensure at least 0.30 m/s (1 fps) velocity under flow conditions and length shall be minimized. Sanitary tri-clamp connections shall be used where possible. Compression type or push-connect hose and tubing configurations are not acceptable. Where the hoses are not constantly circulating and are located within the distribution system (e.g., polisher connections), use of PFA tubing with sanitary flare joints or tri-clamp connections is required.

*Rationale: This is to avoid contamination and joint failure issues. During extended static conditions, PFA minimizes leaching of organics.*

**W. Threaded Connections:** There shall be no threaded connections throughout the high purity system (downstream of RO permeate). Where threaded plastic adapters are unavoidable female plastic adapters shall not be used. Premium density degreased virgin PTFE tape is required.

*Rationale: Threaded joints have crevices and can compromise sanitary conditions.*

**X. UV and Light Infiltration Protection:** Exposed translucent piping systems, hoses, and components (including storage tanks) shall be protected from lighting infiltration and UV light with opaque 20 mil or better polypropylene, plasticizer free PVC, or similar compatible jacket materials, with lap seams caulked where jackets are exposed. Insulation is not required; however adhesives shall not be attached to the protected material unless chemically compatible. PVDF components do not require UV protection, but shall be shielded from light infiltration.

*Rationale: UV light (including fluorescent and daylighting) damages many plastics and light infiltration promotes photosynthetic organisms.*

**Y. Valve Types:** Valves on the distribution side of the RO production system shall be sanitary diaphragm type with travel stop and position indicator. Zero-static valves shall be provided where necessary to comply with dead-leg requirements, including under valve-closed conditions. Valves providing supply and return to individual labs from mains must be zero-static diaphragm (T-valve) type. Valves on the feedwater side of the RO production system may be ball-type. Valves upstream of GAC on the feedwater side of the system may be conventional NSF-61 certified ball valves. High purity EPDM diaphragms for non-ozonated systems and PTFE with EPDM backing for ozonated systems. Sanitary diaphragm valves are required for faucet connections. There shall be no ball valves within the purified water system downstream of the RO. Valves 100 mm (4 in.) and larger shall be diaphragm or UHP butterfly valves of the lug type fitted with a slow-opening wheel handle. Sanitary tri-clamp, flanged, or IR fusion may be used for sizes 100 mm (4 in.) or larger; however, flange joints shall be minimized.

*Rationale: Zero static valves are required for lab branches because it is not uncommon for labs to be shut off for more than 24 hours while other areas remain active (e.g., renovations). Stagnant water in tee-runouts during these closed conditions could induce contamination throughout systems.*

**Z. Lab Faucets/Dispensal Point Faucet Types:** All faucets shall have rigid (fixed) position, non-flexible spouts with a smooth and sanitary interior bore, and non-contaminating high purity valving of either the needle-valve or diaphragm type, and shall be self-draining with no stagnant water pockets. There shall be a dedicated pipe line flow path under constant circulation of at least the required minimum velocity throughout and up to the dispense valve, which shall be located immediately at the point of dispense (and not at the faucet base). Faucets shall be of PVDF or fluoropolymer, stainless steel, or polypropylene construction; except polypropylene is not approved for systems using ozone. Taps shall be labeled as either RO water, “RO”, or “HPW” only. Additionally, comply with the following:

Option 1) Faucets may be field constructed or manufactured to consist of a U-loop style with a zero-static sanitary diaphragm or needle valve (T-valve) for the dispense point. An eccentric (self-draining configured) orifice plate shall be provided at the outlet to limit discharge flow to between 2 and 6 lpm (0.53 and 1.6 gpm), except where self-limited (e.g., through porting of the diaphragm valve). The outlet shall spill over the sink vertically or at an angle of not more than 45° and shall terminate at least 175–250 mm (7–10 in.) above the flood rim. The termination shall be plain end, 8–10 mm (0.25–0.375 in.) diameter.

Option 2) Manufactured high purity water faucets which include separate supply and return piping lines, with two distinct sanitary type piping connections and continuous recirculation from the supply and return connection directly to a high purity needle or sanitary diaphragm type control valve that is positioned at the dispense point without dead-legs may be provided (subject to provisions above). Faucets that do not use two completely independent flow paths with a positive sanitary flow from supply to return (e.g., tube-in-tube and similar arrangements) are not acceptable.

*Rationale: Inadequate faucet/outlet tap configurations can contribute significantly to contamination of central systems, poor water quality, and extensive microbial problems, as well as sanitization and disinfectant flushing issues.*

**AA. Distribution System Backflow Protection:** Systems shall not be subject to contamination from points of use due to backflow or cross-connections. Methods utilized shall not result in degradation of central system water quality. The application of suitable point of use break-tank reservoirs with normally closed manual or automatic fill valves, a physical fixed visible air gap at the fill connection, or the use of dedicated point of use systems (e.g., connected to tap water) are the required means of protecting central systems from backflow associated with connections to any equipment that does not have an integral listed air gap arrangement (with the exception of water polishers). The fill to such tanks (or air gaps) shall fully drain downstream of the fill control valve when not under pressurized demand flow. Each break tank arrangement shall be provided with adequate drainage to prevent overflow and any possible submerged inlet condition, and shall include a fill port and access for routine cleaning. As discharge from break tanks may require repressurization, placement restrictions (for gravity fill to equipment), or special equipment procurement selections; these issues shall be coordinated with the specifier/purchaser of equipment requiring purified water. Point of use microfiltration is inadequate due to potential of back contamination (grow through), as well as lack of chemical and back pressure protection. Direct connections from central systems will be permitted only where a fixed air gap is provided. Laboratory purified water faucets/taps shall terminate with a clear air gap above the receiving fixture flood level rim.

**AB. Flexibility Analysis, Over-Pressure Protection and Anchorage:** Thermal movement shall be accommodated through the use of appropriately sized expansion loops, piping offsets, or fluoropolymer lined non-corrugated braided stainless steel hose. Overpressure relief provisions downstream of the RO permeate tank shall be sanitary rupture disk type only. In general, plastic piping shall not be clamped or rigidly restrained.

**AC. Pipe Support:** Plastic piping shall not be anchored rigid with metal clamps. Horizontal piping typically requires frequent, and in some cases continuous support.

## 12.1.7 Flow Control/Balancing/Monitoring

**A. Flow Control and Measurement Provisions:** Each branch connection to the return main shall include provisions for flow control and a method for flow monitoring as outlined in this section (except that fixed orifices/restrictor tubes with designated values and engineered design do not require flow meters where the application is on branch lines to laboratories or individual circuits within a lab). These requirements shall be appropriately coordinated with the sizing of the system.

1. Where manual valves are utilized for flow adjustment, valves shall be sanitary diaphragm or sanitary needle-type designed for use in high purity systems, shall include a position indicator/markings of set position, and shall be of reduced size or special porting for reliable control.
2. Engineered orifice plates or PFA restrictor tubing with sanitary connections is preferred for individual labs and branch lines. Manually adjustable flow control valves with a flow meter shall be utilized for an entire floor or entire wing.
3. Manually adjustable valves shall not be located where subject to tampering. Required set points shall be recorded in the O&M documentation.
4. Within the distribution system, flow control is required to be provided at least at the following locations:
  - a. The common return main serving each individual floor of each individual wing at the connection to the primary system return riser/main. Monitoring of the return main for each floor of each wing (after the last lab connection) shall be sufficient to ensure turbulent flow for each main.
  - b. For each laboratory at the connection back to the return main serving the labs on that floor.

**B. Flow Control/Measurement of Serpentine and Single Pipe Systems:** Flow control is required at the end of each supply for each floor of each building/wing.

**C. Flow Monitoring, Non-Contact Electronic Flow Meters:** Non-contact electronic flow meters shall be provided and designed for use with high purity water, shall



not be conductivity-based, and shall be constructed of stainless steel, PTFE, PVDF, or the same material utilized in the piping system. Permanent meters shall be vortex type (transit time is also acceptable). Ultrasonic is not acceptable. Each flow meter shall provide local visual display of flow rate (at the device). Where electronic meters are used for individual lines or labs, only local display is required (no alert to the BAS). Alert points shall be to ensure required minimum velocity. Provide a permanently installed non-contact electronic flow meter for the following locations:

1. Return line from each individual pressure zone, prior to connecting to storage tank and upstream of any back-pressure regulator.
2. Main return line for each individual floor of each individual building wing (prior to connecting to common return riser/main) unless waived for a small project application, in which case a visual indicator (e.g., rotometer) is required as a minimum.

*Rationale: Electronic flow meters provide immediate alert of significant malfunction or maladjustment in the system and can save significant effort in troubleshooting system issues.*

**D. Flow Monitoring, Rotameters/Variable Area Flow Meters:** 316 L stainless steel, PTFE, PVDF, or polysulfone rotameters may be provided for small systems in lieu of electronic meters for individual returns (e.g., circuits with manual balancing valves) or for facilities where central monitoring is waived by ORF.

**E. Flow Restrictor/Orifice Plate Material:** Orifice plates shall be solid PVDF or shall be 316 L stainless steel, electropolished, minimum 20 Ra. manufactured type only, with sizing tab. Field drilling is unacceptable. ASME BPE compliant sanitary tri-clamps shall be utilized with approved elastomers and the tri-clamp shall be provided with a manufacturer specified torque nut as recommended by the orifice plate manufacturer. Bore shall be eccentric for horizontal piping and arranged to facilitate draining. Restrictor tubes shall be PFA only of engineered length.

**F. Pressure and Flow Rate Documentation:** Proper system pressure and flow rate set points as associated with control components shall be recorded on drawings

and in O&M documentation. Orifice plate schedules or other clear drawing identification shall be provided.

### 12.1.7.1 Distilled Water Systems

**A. Stills:** The use of central distilled water (other than for WFI/pharmaceutical applications) is not acceptable at the NIH.

*Rationale: Although water quality from a well-designed and properly operated still fed from single pass RO can maintain very high water quality, the operating cost and maintenance needs of such central systems limit their use at the NIH.*

## 12.1.8 Special Provisions for Microbial Control and Sanitization

**A. Design Provisions:** Systems shall be designed to achieve required water quality without requiring constant or frequent sanitization.

**B. Chemical Sanitization:** The required sanitization method at system startup, is hydrogen-peroxide/peracetic acid solution. Chlorine is not acceptable. Ozone and hydrogen peroxide/peracetic acid solution is the approved routine sanitization method.

**C. Ozonation for Microbial Control:**

1. Ozone generation, where approved, shall be electrolytic generation method only, provided as a side-stream loop through a static mixer for the storage tank) with the UV-destruct placed after the tank prior to distribution with full recirculation to use points and then back to the tank.
2. Ozonation systems shall not be utilized without prior adequate control of TOC to avoid potential byproduct concerns.
3. Ozone residual shall be maintained continuously within the water storage tank by injection into a side-stream loop and destructed centrally prior to distribution by the UV.

4. Loop sanitization shall be accomplished periodically by shutting off the central UV and monitoring satisfactory ozone levels in the return (typically for less than an hour). Once complete, the post ozone UV shall be activated to destruct ozone and use of outlets not permitted until ozone has adequately disintegrated in the associated dead-legs (overnight typically provides substantial safety factor at the levels utilized for routine microbial control) or other positive means of destruction provided.
5. Storage tanks shall include submerged dip tubes and sparging in lieu of spray balls to maintain ozone levels and reduce off-gassing losses. Separate returns and separate tanks/pumps should be used where multiple pressure zones are required. Where the recirculation system must be returned to atmospheric (e.g., for systems with multiple return pressure zones back to a single system), the use of spray balls or other air break arrangements are acceptable provided the ozone injection is through a side-stream loop with static mixer into the storage tank through submerged dip tubes and sparging and ozonation sizing is appropriately considered to maintain ozone residual into the water. Tank overpressure protection (e.g., low pressure stainless rupture disk) shall be provided and the rupture disk burst indicator shall shut off ozone production.
6. A warning sign shall be provided adjacent to ozonated water tanks or near the tank opening to direct disablement and flushing or ozone destruct for any ozonated tank which has an operable port or for service of vents.
7. The water supply to the ozone generator shall include a supply on the upstream side of the back pressure regulator (side of the valve that will reliably have water flow under all conditions of operation). A check valve shall be provided for any connections made back from ozone generator to the loop to ensure proper flow direction and protect from ozone migration into the loop.
8. Leak detection shall be provided for the area housing ozonated water tanks. Tanks shall be labeled indicating presence of ozone.
9. Vents for ozonated tanks shall include an ozone-destruct arrangement (stainless steel housed, heated type only. Catalyst type is not acceptable). Filters ahead of any such ozone destruct shall be PTFE, hydrophobic. Vents shall be properly sized to provide for off-gassing relief with an appropriate safety factor.  $N + 1$  redundancy is required for ozone destruct. The arrangement of ozone destruct vents shall be configured to be effective and safe without compromise of the system water quality or sanitary conditions.
10. Ozone injections lines shall be electropolished 316 L stainless steel or compatible welded fluoropolymer and shall be leak tested.
11. Where systems are ozonated, the storage tank shall be maintained not to exceed 21°C (70°F) unless sufficient ozone production and efficiency has been demonstrated. In all cases distribution systems shall be maintained at not to exceed 21°C (70°F) prior to ozonation. The use of lower temperature operation of RO systems may be considered and coordinated with RO membrane selection. Required operating temperature of ozonated systems shall be noted on adjustable temperature controls with warning labels. A temperature sensor is required at the main return of each recirculation loop and shall be arranged to prevent deactivation of the ozone destruct system unless the loop is sufficiently cool to maintain ozone in solution, and to alarm upon any override. Where tanks are constantly ozonated, temperature of water must be considered in ozone sizing calculations.
12. Provisions to control ozone off-gassing within the water storage tank and throughout the distribution system shall be included. Placement of storage tanks and relief vent (with ozone destruct) located at the top of the distribution system is required unless determined unnecessary. Where vent reliefs are required to control ozone off-gassing (and for tank vents), the vent shall route through ozone destruct. Avoid air pockets in the distribution and production system; however, maintain a closed distribution loop unless any vents/openings are hydrophobic filtered and fitted with ozone destruct prior to discharge to an approved exterior location.



13. Wetted/ozone contact materials shall be compatible and in conformance with recommendations of the International Ozone Association and requirements of the *DRM*; including piping materials, components, elastomers, faucet taps, and connector tubing that may be subject to ozone exposure. FKM is the minimum acceptable elastomer (EPDM is not approved). High purity FFKM (perfluoroelastomer) may also be used where compatible with the application. Vent material shall be 316 L electropolished stainless steel until downstream of ozone destruct (or may be IR fusion PVDF if not subject to damage), then may be stainless steel, PVDF, or schedule 80 PVC as appropriate. The A/E shall review the need for heat tracing to control vent line condensation. Vent penetrations through the roof shall be stainless steel, properly labeled, turned down, stainless steel screened, enlarged for required free area, and raised above potential snow line or blockage. All vent lines shall be self-draining to prevent blockage.
14. Ozone shall not be maintained constantly in distribution systems without prior justification and approval. Where such configurations are approved, piping material shall be PVDF or 316 L electropolished stainless steel. Ozone residual shall be maintained constantly in the water storage tank.
15. Where a common system serves multiple building wings or multiple systems with individual returns, each such system return shall be provided with its own dissolved ozone monitor. Where common ozone serves multiple building wings, system zoning for sanitization shall be planned and approved by ORF and may require individual destruct systems.
16. Regardless of the presence of ozone destruct, all vents shall terminate to the exterior at a safe location at least 76 m (25 ft.) from air intakes, building openings, or other occupied areas, and at least 76 m (25 ft.) above surrounding grade, plants, animals, etc.
17. Calibrated, high quality, and high accuracy automatic dissolved ozone monitors requiring no chemical additions shall be provided at least at the following three locations: on the main return loop from the building (for each pressure zone in the case of systems serving multiple zones), for the discharge from the storage tank, and for post-UV destruct. Manufacturer recommended flow cells shall be provided for each instrument and the arrangement shall ensure accurate measurement in consideration of system flow and pressure conditions. The A/E shall provide justification for the dissolved ozone monitor selection in consideration of accuracy, reliability, and maintenance requirements. Additional monitors shall be provided as required to ensure efficacy of monitoring.
18. After ozonation and sufficient destruct time, an automated loop flush may be applied where beneficial.
19. Failure of the UV destruct, vent destruct, dissolved ozone monitor, water supply failure, detection of high level ozone to the loop during normal operation and other conditions as warranted shall individually incorporate an automatic safety interlock to provide ozonator shutdown, alarm; and in addition, at levels above 0.1 ppm, distribution shutdown. The ozone destruct UV system shall be monitored independently from the dissolved ozone monitor. Vent destruct shall be monitored. Critical safety faults, including ozone destruction, shall be hard wire interlocked to stop ozone operation. Operating set point changes and temporary overrides shall require a high level pass code, and temporary lower level overrides (e.g., may be utilized by knowledgeable personnel for a heavy disinfection shall automatically revert back to 0.1 ppm after 4 hours).
20. The location and arrangement of ozone systems shall include ambient ozone monitoring alarms with an automatic high limit ozonator shutdown. Any detection in ambient air above the OSHA action level shall provide ozonator shutdown and local and remote monitored alarm. Ozone monitoring shall be in accordance with manufacturer recommendations, but in no case less than one monitor per 50 m<sup>2</sup> (538 ft<sup>2</sup>) of room area. Coordinate with the HVAC discipline to ensure safe ventilation conditions. Ambient ozone monitors shall be UV absorption type

with a validated (certified) lamp and a monitor alarm. Ambient ozone alarms shall provide both local and remote alert to locations as directed by the PO.

21. The required residual ozone levels for each application shall be determined on-site through consultation with the ozone system engineer or manufacturer for required efficacy, frequency, and off-gas conditions. Ozone levels within the tank are typically maintained at approximately 0.1 ppm and destructed prior to distribution. Typical ozone levels for loop sanitization are in the range 0.1–0.3 ppm; though application as high as, but not to exceed, 1.0 ppm may be permitted where justified if compatible with system and safety (including off-gas consideration), where the ozone destruct arrangement has been sufficiently upsized, and provided the method of generation is only electrolytic. Actual concentrations are determined by project by the ozone engineer, however normal operating levels above 0.3 ppm shall be justified and are subject to approval. Frequent sanitization at very low levels (e.g., 0.05–0.1 ppm) are recommended to minimize off-gas hazards and prevent the establishment of significant biofilm but may not be required where other microbial control practices have been appropriately addressed in the design and construction. Where an increase above these levels is required, it shall be made only via temporary override, with passcode protected access and automatic reversion back to base set point. Designs shall be capable of distribution system sanitization to between 0.3 and 0.5 ppm.
22. Where ion exchange is utilized, a bypass shall be provided and located to minimize the portion of the piping that will not be sanitized.
23. Ozone system sizing, including system specific variables, off-gas loss, distribution design, and safety protections shall be additionally reviewed and acceptable by the ozone system manufacturer.
24. Ozonator system startup and training shall be performed with the manufacturer or qualified manufacturer's authorized representative. A comprehensive guide for routine use, tank, and loop sanitization shall be provided; including

all relevant safety protocols and recommended maintenance frequency. A safety analysis shall be provided by the ozone system manufacturer or other qualified individual, identifying significant likely component failures and operator errors and methods to safely detect and mitigate these issues. This document shall be included in O&M manuals and training.

25. All ozone systems shall be commissioned. Post ozone destruct times for fixture branch run-outs (e.g., typical polisher connections) shall be confirmed with the appropriate safety factor, verified and recorded in the procedures manual.

***Rationale:** Ozone systems can provide means for routine sanitization, minimizing lab disruption. They should be considered for large systems. Electrolytic ozone generation provides for direct production and injection into the water; thus simplifying systems, dissolution, maintenance, safety concerns, avoids toxic gas piping, provides additional safe control of ozone levels and the injection process, minimizes potential for gas bubbles which can bypass ozone destruction, and avoids potential impurities and water quality fluctuations.*

## 12.1.9 Quality Control and Quality Assurance

Detailed Quality Control/Quality Assurance plans are required for tailoring to individual materials of construction (e.g., fusion, weld, fabrication, passivation, testing, and sanitization). The requirements listed below shall be appropriately addressed:

1. Welding for piping regardless of type (including plastic systems) shall comply with ANSI/American Welding Society (AWS) specifications for welding procedures, performance qualifications.
2. Specifications shall mandate installations be performed by qualified personnel with high purity systems of similar cleanliness and material type.

Recent training and certification (within 12 months) is required for each installer for the specific fusion equipment for fabrication of joints and welding qualifications. Refer to [Exhibit 6.3](#).

3. Systems shall be protected from contamination throughout materials handling, construction, testing, and until final acceptance and use.
4. A QA plan inclusive of random nondestructive testing shall be provided. Weld coupon verification for each welder/machine, calibrations, proper installation and cleanliness procedures shall be addressed through QC and an independent comprehensive QA process.

*Rationale: Improperly installed systems may not maintain system water quality requirements or be subject to other costly integrity issues.*

---

### 12.1.10 System Completion, Startup and Verification

**A. Contamination Protection:** Precautions shall be taken throughout the startup, testing, commissioning, and preoccupancy phases to prevent proliferation of biofilms or other loss of system capability to reliably deliver required water quality. Where systems are wetted, microbial control must be maintained. Where systems are drained, they must be dried with a purge of clean, dry, filtered argon from a cryogenic source; however, compressed gas pressurization shall not be applied to plastic systems. Only high purity water (at least RO or RO + DI and with microbial filtration) shall be introduced in the distribution system, including for flushing and pressure testing.

**B. Pressure Testing:** Systems shall be tested at 150% design operating pressure for 8 hours, or at the maximum working pressure ratings of the system (whichever is less). Minimum hydrostatic test pressure shall be at least 690 kPa (100 psig) unless approved by the PO. The A/E shall consider the pressure ratings of any joint components which may be limiting factors and independently test, isolate, or reduce test pressures as appropriate. Test assemblies shall be clean and constructed of materials suitable for use with high purity systems to not introduce contaminants.

**C. System Startup:** Systems shall be flushed, sanitized and commissioned prior to acceptance. Startup procedures for each component shall strictly follow manufacturer's instructions. All media beds (carbon, softeners, etc.) shall be properly conditioned, particle sizes spread/backwashed, fines flushed, soaked, etc. All instrumentation and controls shall be properly adjusted and calibrated. All set points and alarms shall be verified. Presence of proper filter media, elements, carbon, chemicals, UV, etc. shall be verified without contaminating systems. All components shall be verified for proper operation. The system flow rates (each circuit) and pressure sustaining valves shall be adjusted and verified, including pressure sustaining valve response/adjustment at simulated peak demand. Presence of proper size/location and orientation of flow restrictors shall be confirmed. Omission of cross-connections shall be verified. Commissioning, including integrated systems testing is required.

**D. Sanitization, Water Sampling and Laboratory Analysis:** System sanitization, water sampling and associated laboratory analysis is required as part of the system verification, prior to acceptance.

# Section 12.2

## Animal Drinking Water Systems

---

### Contents

12.2.0 Introduction

12.2.1 General Requirements

12.2.2 ADW Production Systems

12.2.2.1 ADW Production System Components

12.2.3 Barrier Facilities

12.2.4 Microbial Control

12.2.5 Distribution

12.2.6 Disaster Mitigation

12.2.7 Materials

12.2.8 Startup and Verification

## 12.2.0 Introduction

This section addresses the provision of animal drinking water (ADW) systems. It is not all inclusive of *DRM* requirements and shall be used along with other sections of the *DRM*. Refer to [Section 8.1 Plumbing General Requirements](#), [Section 8.3 Water Systems](#), [Section 12.1 High Purity Water Systems](#), and [Appendix N](#) for additional criteria and guidance associated with these systems.

The requirements of this section are intended for the typical animal research models used at the NIH, including small vertebrate mammals up to and including non-human primates (NHPs). Where large animals are utilized, variations of requirements may apply and shall be evaluated on a project-specific basis to ensure not less than plumbing-code compliant fresh, potable water. The requirements of this section of the *DRM* are not intended to apply to non-mammal species, including aquatics and semiaquatic amphibians.

### 12.2.1 General Requirements

**A. Criteria:** Services to animals at each point of delivery shall be in accordance with the latest editions of the (a) Public Health Service Policy for Humane Care and Use of Laboratory Animals, (b) the ILAR Guide, (c) AVMA guidelines and (d) appropriate to the species and to not induce research variables. Water quality at the point of delivery to the animal shall be at least potable per Safe Drinking Water Act (SDWA) 40 CFR Part 141 at all times.

**B. Method of Delivery:** Selecting the method of delivery of the ADW supply (e.g., central bottle or packet fill, piped distribution, local sterilized, or prepackaged) shall be made based on program requirements. This should occur during initial programming to account for space allocation and facility operation e.g., clean cage wash processing areas and required SOPs.

Where water is to be produced and stored on-site, deterioration of water quality (especially due to microbial contamination) shall be addressed. Water that is bottled or packaged on-site shall meet the requirements of this section and in addition shall be prepared (bottled or packaged) for immediate use. Water that is not prepared for immediate use shall be subject to the head

veterinary staff approval and shall be in compliance with the following:

1. Water prepared with addition of suitable U.S. Pharmacopeia (USP) or American National Standards Institute/National Sanitary Foundation (ANSI/NSF) 60 grade disinfectant at levels in accordance with potable water standards. Water is maintained appropriate sealed containers stored and used within shelf life.
2. Water has been prepared and packaged in compliance with 21 CFR 165.110 and 21 CFR 129.
3. Water is refrigerated and used or dispensed within shelf life prior to deterioration.
4. Water is sterile produced and packaged in accordance with an appropriate aseptic technique with suitable packaging and dispensed within shelf life prior to deterioration.

***Rationale:** Bottle-fill and prepackaged arrangements may be ideal for limited program areas (e.g., barrier facilities, high containment, and areas where risk of flooding cages may be of high concern). These systems are typically labor intensive, offer non-continuous supply and cause can cause deterioration of quality. Automated, piped systems are generally preferred for larger facilities and applications with NHPs and large animals. Where water is filled in non-aseptic conditions or with non-sterile water, the fluid quality will deteriorate if not provided with adequate microbial protection and suitable clean packaging.*

**C. Sterile Water Quality Validation and Deterioration:** Sterile water shall be produced through a verified process. Hyper-chlorination, acidification, or inclusion of an autoclave process is not an automatic indicator of sterility or that sterility is maintained. Use of approved USP-grade additives and additional special handling may be required and shall be determined on a project specific basis.

**D. Chemicals and Additives:** Chemicals and additives shall be ANSI/NSF-60 grade and subject to approval of the program veterinarian. The use of USP-grade additives or other special handling may be required



consistent with quality requirements for the application to ensure quality and purity. The use of additives shall be reliably controlled and automatically monitored. Maximum levels shall be in conformance with SDWA and ANSI/NSF-60, but in no case greater than permitted by the program veterinarian.

**Rationale:** *Non-USP or non-ANSI/NSF-60 grade additives may contain contaminants including heavy metals. Inadequate control of purity, concentration of additives and use of unapproved additives in drinking water applications violates SDWA potable water standards and requirements.*

**E. Central Fill vs. Piped Distribution Criteria:** The water source, production requirements, and system design providing water for central-filled animal drinking water systems (e.g., bottle and packet fill stations), including point of use treatment systems are subject to the same requirements as for piped distribution of animal drinking water.

**Rationale:** *The method of delivery does not change the requirement for water quality and continuity.*

**F. Determination of Risks:** In determining the arrangement of ADW systems, the A/E shall ensure that risks which may compromise reliable water quality and continuity up to the point of delivery to the animals have been considered and discussed, and that required design actions have been integrated to ensure a continuous, reliable, controlled, and high quality water supply. This includes but is not limited to identifying and addressing: potential disruptions or loss of source water supply; site-specific hazards; unplanned loss of assumed source water quality; production/treatment system failures; plausible system malfunction; line breakage; electrical and standby power failure alert; response-, system-, or equipment-monitoring failures; cross-contamination and backflow; tampering; microbial contamination prevention and detection; and system security. The special needs and risks associated with each portion of the system shall be addressed, including unique characteristics and risks inherent with each design approach (e.g., potential for byproducts, microbial contamination, and additive levels control). Even where anticipated variations are determined acceptable for a specific program,

steps to control and maintain stability of water conditions and continuity of supply and to protect and maintain that quality within those parameters is required.

**Rationale:** *Proper planning and consideration of whether such issues require enhancements of engineered design or facility SOPs can minimize risks to animal health, control of stress, and minimize research variables. Continuous, clean drinking water free of contaminants toxins and viable pathogens is mandatory.*

**G. On-site Water Testing:** On-site water testing shall be performed during the design phase to analyze the influent water quality and confirm appropriate treatment and any necessary pretreatment steps to ensure reliable and trouble free performance. The investigation of available water supply quality shall include the determination of seasonal and source variations in the water supply and the extent of contaminants.

1. The testing shall be carried out by a water quality lab that is at a minimum accredited in accordance with International Organization for Standardization (ISO) 17025 by a signatory to the International Laboratory Accreditation Cooperation (ILAC) mutual recognition agreement and performing testing that is within the scope of their accreditation. Sample collection shall be carried out either by the lab or under their direction by experienced personnel. At least two on-site (or in the case of new construction, near-site) representative samples shall be taken, and shall consider the worst case source water condition (e.g., generally the surface water supply).
2. Where a facility incorporates upstream water treatment (including centralized softening of potable water distribution or other centralized treatment, disinfection, or adjustment), any byproducts of the upstream treatment process and actual water qualities at the location of the proposed ADW system shall be evaluated to determine the actual available water supply at the ADW production equipment.
3. Testing shall include all parameters as may influence the proper and reliable selection of reverse osmosis (RO) or membrane systems (if



applicable) and determination of any additional pretreatment equipment. Private water supplies shall additionally include the full battery of potable water tests per the SDWA, including radionuclides. ASTM D4195 Standard Guide for Water Analysis for Reverse Osmosis and Ultrafiltration may be utilized. The A/E may also refer to [Section 12.1 High Purity Water Systems](#) for further guidance.

4. Where the system will only be of potable type (with no treatment process), specific contaminants of concern shall be identified and tested for after consultation with the user group. At minimum this shall include testing of residual disinfectant level, microbial levels (including at least heterotrophic plate count *E. coli*, and coliform), lead and copper levels, conducted as on-site testing. Where solvent cements or similar chemicals are present in the system, testing shall include those specific chemicals, or at a minimum total organic carbon (TOC), and may in some cases need to include disinfection byproducts and endocrine disruptors as determined by the needs of the program. Where systems are from private supplies (not municipal SDWA regulated), comprehensive water supply testing and analysis is required.
5. Upon receipt of testing, the A/E shall perform the comprehensive water quality analysis to ensure appropriate equipment selection and identify and address any concerns unique to the project site and research program.

**Rationale:** A proper understanding of source water conditions is essential for appropriate treatment, assurance of reliability, and minimization of maintenance. On-site sampling is required for accurate and reliable representative data on water quality. Required test parameters can vary with source and supply type and a number of site variables, including anticipated treatment methods. The primary goal of testing water supplies that are served from reliable municipal SDWA compliant supplies ensures appropriate pretreatment and treatment equipment selection.

**H. ADW Location:** The location of ADW system components shall be approved by the program and shall consider requirements to maintain system quality, continuity, and security. Systems shall be located in a clean, normally occupied, environmentally controlled space with restricted access. Distribution piping systems shall be located only where environmentally controlled and protected from temperature extremes. Piping shall not be located immediately adjacent to steam or other high temperature water piping (regardless if piping is insulated). Outlets and ports, including drinking water nozzles, shall not be located where subject to likely contamination, accumulation of dirt, in front/next to exhaust grills, or at areas where subject to exposure to chemicals or other hazards.

**I. ADW Independent, Dedicated System and Supply Backup:** The ADW production and distribution system shall be completely independent, dedicated, and separate from any other water system and shall not serve or interconnect with any function other than animal drinking water. System makeup shall be supplied directly from connection to potable water systems (not lab or other purified water) and shall be provided with dedicated ASSE 1013 backflow protection.

**Rationale:** Laboratory water supplies (including high purity water) may not be consistently suitable and under the necessary control for ADW and do not meet potable water system requirements. Requirements for operation and maintenance of an ADW system versus for other laboratory and purified systems may not be compatible and could be at risk associated with chemical usage and variables beyond control of the ARF staff.

**J. System Backup:** A non-stagnant pressurized potable water backup connection shall be provided for emergency bypass service or redundant online dedicated ADW production equipment. Backups from other systems are unacceptable. A flush out valve shall be provided just upstream of the point of connection to the ADW distribution and the normally closed valve at the interconnection shall be located immediately at the distribution connection to preclude dead-leg.

**K. Protection:** No item, equipment, design or installation arrangement shall be introduced into the system that

can plausibly cause contamination or risk to safe water quality, regardless of system pressure or flow status.

**L. Documentation:** ADW systems shall be fully engineered and documented to the same extent required as for other plumbing and process systems. The A/E shall either completely design and document ADW systems or (where acceptable to the PO) provide sufficient documentation of the intended system arrangement for final vendor design and subsequent A/E and NIH approval. Vendor designed systems are not exempt from DTR review and *DRM* requirements.

**M. ADW System Monitoring:** The ADW system shall include appropriate instrumentation, equipment, and alarms to facilitate monitoring of critical system performance parameters. Instrumentation shall be appropriately calibrated and instrumentation connections shall be designed to minimize dead-legs. Instrumentation shall be applied, installed, and set up consistent with manufacturers' requirements. Sampling ports shall be located and configured for effective sampling and selected and arranged to prevent dead-legs. Monitoring shall be to the program approved location/ARF monitoring system.

**N. Verification Prior to Use or Occupancy:** Systems shall be completely flushed, sanitized, and validated for water quality at both the source equipment location and terminal outlets after completion but prior to use or occupancy.

**O. ADW Discharges:** A proper air gap above flood level rim is required for all discharge points.

**P. Standby Power:** The entire ADW system, including monitoring and alarms shall be on building standby power.

---

## 12.2.2 ADW Production Systems

**A. Design for the Research Model:** In establishing ADW supplies, the water quality needs of the research model shall be addressed. Consultation with the program should occur during planning phase and shall address future planned usage but does not waive *DRM* requirements.

**B. Treatment Methodology/System Configuration:** With limited exceptions, dedicated RO with either preliminary granular activated carbon (GAC) or activated carbon block filtration is the required treatment method for makeup water supplies. The addition of chemicals is not acceptable and chemicals shall not be used as a substitute for softening, to address anti-scaling functions, or as a substitute for activated carbon (to address chlorine and chloramines). This is not intended to prohibit use of residual disinfectants or pH adjustment of water that has been treated on-site by the RO process. The use of oxidizing UV for chlorine reduction in lieu of carbon is not acceptable due to potential byproducts of oxidation of organics.

***Rationale:** The use of RO water (preceded by activated carbon) provides a stable baseline to allow facilities control over water quality, protects from unforeseen variations, endocrine disruptors, trihalomethanes, radionuclides, and various unregulated contaminants and pesticides, and allows controlled addition of disinfectants with minimal risk of byproducts. Water that is potable for human consumption may require additional treatment to ensure the water is reliable and suitable for various animal models in biomedical research programs, and minimizes the potential of unintended research variables. ADW systems are at enhanced risk of microbial contamination and are well served by RO when followed by additional microbial control measures (e.g., provision of residual disinfectant and flushing).*

**C. Exceptions to RO Systems:** The best acceptable technology to maximize local control, while ensuring conformance with the requirements of the animal model shall be utilized. This may at times consist of alternatives e.g., nanofiltration with activated carbon pretreatment, or ultrafiltration; each with specific pretreatment arrangements, and if necessary reintroduction of minerals to controlled levels in the water or diet, along with microbial control. Additional requirements include:

1. Omission of RO with activated carbon is not acceptable for animals of non-conventional health status (e.g., immunocompromised, SPF, etc.) or where water quality must be controlled to prevent inducing research variables. Where large animals are of conventional health status,

spend significant time outdoors or are likely to obtain water from other sources, and provided research and health would not be affected it may be acceptable to omit RO, provided the water quality at each use point is reliably potable per SDWA, and provided no additional chemical adjustment or disinfectants are added, sufficient water turnover is achieved, and municipal applied residual disinfectants are present at required levels throughout.

2. Where lesser treatment approaches than RO are to be utilized, it shall be determined that the risk and variation of water quality (including those of unregulated contaminants) and the removal capabilities of the associated technology that is to be utilized (or omitted) is acceptable and will not result in a water quality that may compromise research, pose a risk to animals, or loss of appropriate facility program flexibility.
3. Where RO is determined unacceptable by the program veterinarian or its omission is justified and approved, nanofiltration shall be utilized. Where nanofiltration is also determined unacceptable by the program veterinarian and justified, ultrafiltration or microfiltration should be provided while maintaining municipal applied disinfectant (chlorine) residual.
4. The use of carbon shall require downstream RO, nanofiltration, or ultrafiltration, in addition to maintenance of disinfectant residual to provide microbial control.
5. The application of pretreatment filters and/or carbon filters alone to remove particulate and residual disinfectants (e.g., taste and odor filters) may leave the system prone to excessive microbial and biofilm contamination or other contaminants and is not acceptable.
6. Chlorination or chlorine dioxide within levels of the SDWA shall be used; however, acidification and other chemicals shall not be added to water that has not been controlled through use of RO or nanofiltration and comprehensive water quality evaluation and monitoring. Chlorinated water shall not be acidified, including potable (as supplied) water. Chlorine levels must be controlled and potential unannounced changes that may occur by the water purveyor and the type or quantity of disinfectant utilized must be reliably addressed. Chlorine shall not be added to water that has not been pretreated (e.g., by RO) and where subject to creating disinfection byproducts.
7. It shall be demonstrated that contaminants including biofilm and associated microbial risks, disinfectant residuals, etc., will be appropriately controlled. Water scale potential must be evaluated and addressed as required.
8. Where untreated potable water is determined acceptable (typically allowed only for large animals of conventional health status) the arrangement shall be in full conformance with plumbing code and [Section 8.3 Water Systems](#).
9. Appropriate controls to minimize risk of cross-contamination and SOPs in the event of a known water supply emergency must be addressed.

**Rationale:** *It is important for water systems serving animals to include at least microbial controls and stabilization/protection of water quality as these systems are at enhanced risk of microbial contamination. Inappropriately applied or maintained filter use can harm long-term water quality.*

**Rationale:** *Significant risk to science, animals, and costs can be associated with contaminated ADW systems, especially where severe biofilms with viable pathogens develop. Water quality can change significantly in a very short period; therefore, testing at least quarterly should occur. Sudden unplanned events can lead to boil-water orders or other precautions, which can be difficult to quickly implement or may not be immediately detected.*

10. The distribution system shall be arranged to protect from internal backflow or cross-contamination to ensure potability of the water to the point of each outlet and to maintain required levels of residual disinfectant. Approved ADW distribution materials shall be utilized that incorporate low-extractable, corrosion-resistant

characteristics under the range of water quality exposure to maintain required water quality.

**Rationale:** Ultrafiltration and nanofiltration, while providing substantial filtration and microbial reduction, may leave systems prone to certain contaminants. Nanofiltration can be selected where required to preserve various minerals. Ultrafiltration only provides microbial protection and does not protect from other contaminants or establish control of organics necessary for any changes in water chemistry (e.g., disinfectant additives). Properly selected and maintained microfiltration at bottle fillers can limit microbial hazards in some applications. ADW systems operate at low velocities at room temperature and without comprehensive microbial control can be unsafe. Nanofiltration and ultrafiltration may be selected for applications with higher tolerances to contaminants and influent water supply variability, though not as a substitute for RO.

**D. Water Softening:** Where water softening is needed, duplex automatic alternating equipment is required with potable water resin. Refer to [Section 12.1 High Purity Water Systems](#) for additional information. RO systems shall be provided after softening, unless justified and approved by NIH.

**E. Remineralization/Additives:** Where RO or water softening is employed in the feed water supply the A/E shall verify with the program veterinarian if there is special concern or need for diet additives (e.g., vitamins, USP mineral supplementation, magnesium, calcium etc.).

**Rationale:** Once water has been softened, calcium and magnesium are largely removed and systems may be at increased risk of microbial contamination associated with brine, resin, and maintenance. Downstream RO and subsequent disinfectant residual and addresses elevated salt levels and provides initial microbial control. Neither the RO nor softening in themselves result in mineral deficiency. Treatment by RO and planning discussions allows programs to have consistent control of nutrients.

**F. Ultraviolet Disinfection:** The use of ultraviolet germicidal irradiation (UV) is not acceptable as the exclusive means of microbial control and is not a substitute for RO, regardless of presence of system circulation. Where UV systems are utilized, they shall be only 254 nm wavelength. The use of 185 nm UV is not acceptable unless all potential of toxic byproducts have been properly analyzed. Use care in selecting and placement of UV to prevent breakdown of the disinfectant and ensure that the UV does not emit 185 nm wavelengths at sufficient levels to oxidize bleach solutions or induce toxic byproducts.

**Rationale:** UV does not provide presence of a disinfectant residual; therefore, may be of very limited effectiveness as microbes reproduce downstream. Oxidizing wavelengths of UV applied to waters for other than very low level TOC polishing can result in formation of toxic byproducts.

**G. Chemical Compatibility Analysis:** Chemicals added to water supplies shall only be made with a stable source (e.g., RO or nanofiltration waters), or where justified by a comprehensive feed water analysis and suitable monitoring program. The use of acidification of water supplies is not acceptable, unless residual chlorine has first been removed, and shall only be conducted where an RO process inclusive of activated carbon has been employed. Chlorine additions must consider the potential variations of incoming supplies.

**Rationale:** The addition of chemicals to water must be undertaken only with a thorough understanding, control, and monitoring of the chemistry of the incoming water supply. Incoming water supplies can be subject to variation and toxic byproducts can result. Systems are not monitored to the degree and extent of municipal systems where chemistry is analyzed more comprehensively; therefore, a stable baseline to limit potential for reactions must be first achieved.

**H. Deionization and Point of Use Lab Water Polishers Prohibited:** Deionization shall not be utilized for ADW. Point of use laboratory water polishers or point of use deionizers are not acceptable.



*Rationale: Deionized (DI) water addresses ionic contaminants only. The potential for microbial contamination from the beds and high potential variability associated with maintenance and feedwater generally precludes their use.*

### 12.2.2.1 ADW Production System Components

ADW production system components shall be as follows:

#### A. General:

1. Only potable/domestic cold water supply shall be utilized for ADW production. Laboratory water systems shall not be utilized as the supply to ADW.
2. Backflow protection, ASSE 1013 required at point of connection.
3. Prefiltration using 10–20 µm cartridge filters, beta ratio 10 or better at the required particle size and flux, N + 1 filtration arrangements (two filters in parallel), and stainless steel housings.
4. Water softener for scale protection (unless not required due to local water supply condition) to be demand based, automatic, regenerating type, and using potable water-grade virgin cross-linked resin rated for the chlorine/chloramines concentration of resin exposure. Softeners shall be potassium chloride regenerating, except that cartridge water softeners approved for potable water may be used where justified for small systems provided the properly calculated change frequency does not exceed once per month. Size brine tank for 3–4 weeks demand. Service exchange softeners may be used for small systems with a suitable quality (contamination) control process.
5. Activated carbon for pre-RO membrane (or pre-nanofiltration) chlorine removal and TOC reduction shall be provided with a flushing port to permit flushing of fines immediately after the carbon unit(s). AWWA B604 virgin coconut shell or virgin re-agglomerated coal type only (as suitable to the application based on on-site water testing and treatment goals), see [Section 12.1.5](#)

**Production Systems: Common Requirements** for further guidance. Catalytic carbon may be used for water supply with known chloramine. Comply with the following:

- a. Granular activated, two beds in series or combination bed and activated carbon block, total 7–10 minutes empty bed contact time minimum, or greater as required to protect RO membrane and target contaminants. Where service exchange type is used, good manufacturing practice (GMP) and ISO 9001 certification fully traceable for potable water.
- b. Carbon block filtration consisting of at least 2 units in series may be utilized in lieu of GAC. Selected for chloramines removal at not less than 3 ppm and organics and sufficient for the total volume of flow rate between cartridge change intervals (90 days should be assumed for sizing purposes). Carbon shall be certified for potable water.

*Rationale: Cartridge block carbon may be preferred by some facilities for ease of use; however, cartridge life and efficacy for TOC is generally reduced compared to GAC.*

6. RO system pre-filter arrangement consisting of 1 µm beta 10, 3 µm beta 1000, or 5 µm beta 5000 filters, arranged as N + 1 (in parallel), and stainless steel housing.
7. A single-pass, beverage grade RO system with a quality high rejection thin film composite membrane and selection to consider seasonal water temperature requirements. Pretempering of ADW is generally not desirable unless required for condensation prevention. The RO membrane must be compatible and sized in consideration of temperatures.
8. Fail-safe overtemperature control is required. Provide N + 1 (in parallel) ASSE certified thermostatic control arrangement at makeup as required. Cold water makeup may be used where condensation and membrane capacity are addressed. Exposed insulation of ADW distribution lines within the ARF is not permitted.

9. Gas-tight, sealed and filter-vented storage tank (duplex recommended). Refer to [Section 12.2.7 Materials](#) for additional requirements.
10. Redundant (two in parallel), normally operating sanitary distribution pumps. Pumps shall be arranged to preclude dead zones. Pumps shall operate continuously. Utilize VFD's if required.
11. Comply with the following post-RO microfiltration arrangements in N + 1 (parallel) configuration. Where filters are utilized, the change-out frequency requirements to control back contamination must be addressed, communicated to program staff, and documented:
  - a. Where non-circulating (flushing type) systems are utilized, provide microfiltration downstream of distribution pumps (just after the storage tank and pumps), but prior to distribution to outlets. Refer to [Section 12.2.7 Materials](#) for additional requirements. Microfiltration may be omitted for large animal applications and animals of conventional health status; provided chlorination residual between 0.1 to 0.4 ppm is maintained throughout the system or chlorine dioxide residual is maintained, as well as for applications serving all animals where the ADW TOC levels will be less than 500 ppb and chlorine or chlorine dioxide (only) residual is maintained.
  - b. Where systems do not maintain constant post-treatment chlorination or chlorine dioxide residual, low pressure 254 nm UV shall be provided upstream of microfiltration, in a N + 1 (parallel) configuration. Membrane prefilters ahead of the microfilters shall be determined by the A/E on an application specific basis.
  - c. Where circulating systems are utilized, main distribution water shall circulate back through the tank and then through low pressure 254 nm UV, followed by a 0.1 µm microfilter or ultrafiltration.

***Rationale:** Microfiltration or ultrafiltration is beneficial in maintaining microbial control in systems when preceded by RO, especially in addressing microbes that pass imperfections or grow-through the RO membrane. Where circulation systems are used, circulation back through the tank maximizes turnover and agitation. Low pressure UV is required to protect from formation of potential toxic byproducts. Further details of filter requirements are in [Section 12.2.7 Materials](#).*

12. System controls and alarms (including tank level monitoring) are required.
  13. Proportioning arrangement for chlorination, chlorine dioxide, (or acidification where approved) except for systems that operate without disinfectant residual. See [Section 12.2.4 Microbial Control](#).
  14. Proportioning/injector arrangement for mineral supplementation if required.
- B. Monitoring Components:** Monitoring components shall include at a minimum:
1. A programmable logic controller (PLC) with non-volatile memory for control function. Arrangement shall be provided to maintain continuous operation in event of failure of the system PLC. Control and equipment arrangement shall minimize potential for plausible single point failure. Alarm functions shall not fail due to loss of primary power supply. "General Fault" and "Critical Fault" conditions must be remotely annunciated, unless the program requires detailed remote annunciations. Such sequences shall be approved by the program during design. Software and control system shall be validated for proper operation. PLC shall retain a minimum of the most recent 180 days of system status/faults.
  2. Instrumentation and controls for monitoring feed pressure, permeate pressure, interstage pressure, concentrate pressure, online resistivity for feed water and permeate, feed temperature, flow metering for feed water permeate and concentrate, totalizing meter for permeate, temperature and pressure monitoring, control



protection, and an adjustable reject flow rate control valve. Automation shall be provided for controls necessary to protect from system damage (e.g., low feed pressure, high temperature, etc.). Automatic restart shall be provided for RO system features (e.g., low pressure); however, fault conditions shall be recorded. All meters and controls are to be of non-contaminating, sanitary-type configurations.

3. Temperature monitoring for production and distribution systems. A separate monitor for system distribution temperature is required, independent of any monitoring for the RO and/or makeup water system.
4. Vortex-type or other highly accurate non-contaminating meter (not reliant on conductivity) for feed to water storage tank for integration with proportioner/injectors.
5. ADW storage level sensors shall be non-contact type, hygienic radar or pressure based level sensor, and located so that tank shall not need to be emptied to adjust. Ultrasonic level detection is not acceptable. Redundant (in series) tank fill control valve coordinated with tank level controls, except where tanks utilize overflow instead of a sanitary rupture disk. PLC to monitor and alarm high tank level and rupture disk burst indicator.

*Rationale: Use of a sanitary rupture disk for tanks is in lieu of overflow where tanks are not maintained with residual disinfectant. The redundant controls protect from overflow and false rupture associated with a faulty control, leaking solenoid valve, etc.*

6. Distribution pressure monitor (for flushing systems) to ensure system pressure is within minimum and maximum parameters.
7. Oxidation reduction potential (ORP), pH, digital UV intensity and lamp-out indicator(s) for UV (as applicable); each selected and configured for accuracy based on water quality at the instrument's location.

*Rationale: pH and ORP in RO permeate applications will typically require side-stream stabilized flow across the reference junction in a grounded housing. In post-ultrafiltration applications, low ionic strength solutions would not be present.*

8. Additive/reagent level or status
9. Level monitoring and failure alarms for all proportioners/metering
10. Chemical injection-proportioner/feed water totaling a minimum of 180 days of electronic data retention. Verify required duration according to the program requirements. Other monitored water quality parameters shall also be stored in the electronic record if necessary by program.
11. Pressure and flow monitoring of individual pressure-reducing valve (PRV)/flush stations.

**C. Storage Tank:** Usable total storage tank volume shall provide for at least 24–48 hours peak system demand. Sizing shall be based upon daily requirements for the total planned population load (all racks connected) considering daily consumption demand for each species, plus the required 20% overage. The use of duplex tanks in parallel (12 to 24 hours capacity each) is recommended. Tanks shall include individual valves and drain lines. Central storage of unchlorinated water is not acceptable.

*Rationale: Reserve capacity of storage ensures availability of water supply during upstream maintenance or in the event of system malfunction or other supply loss. Frequent water turnover is necessary (not to exceed every 12–24 hours) to maintain water quality. Redundancy of tanks ensures continuity and facilitates maintenance.*

**D. Water Turnover and Production System Capacity:** System operating sequence shall ensure each tank achieves frequent fresh water turnover at least once per day. Production systems shall provide total required capacity to replenish the system in not to exceed 3 hours of operation. Turnover shall be accomplished through programmed flow through the flush valves for the racks/rooms and main lines.

**Rationale:** *Minimum production rates prevent excessive disruption in the event of a system malfunction or maintenance activities, and help maintain water quality with minimal waste. Turnover of water helps to maintain water quality and microbial control.*

**E. Permissible Chemicals:** Chemical additives (other than residual disinfectant or periodic sanitants) are not permitted unless specifically required by source water conditions and treatment process need. Where chemicals are utilized, they shall be only in pretreatment steps, upstream of RO, and fully removed from permeate prior to distribution. Removal shall be automatically monitored and the arrangement of injection shall be fail-safe from over-dosage hazards. Justification is required prior to chemical additions.

**F. Component Coatings:** The use of carbon, filters, media beds, impregnated resins or other water contact components that have been coated with silver, bactericide, utilize redox alloy media, or other chemicals for microbial control is unacceptable.

**G. Valves:** Isolation valves shall be provided for each component so that the system will not have to be shut-down or run in emergency bypass mode for routine maintenance. Tanks, pumps, and components shall be arranged to permit individual shutdown and isolation. Where systems operate chemical free (without disinfectant residual), sampling valves shall be in accordance with requirements of [Section 12.1 High Purity Water Systems](#).

**H. Undisrupted Water Supply:** The entire system shall be designed to provide for undisrupted supply of ADW to the ARF dispersal points (or bottle/packet fill station). Common system components and major controls shall be arranged to minimize the potential of plausible single point failures that could result in disruption of required drinking water supply.

**Rationale:** *Plausible failure of a single component e.g., a distribution or pressure pump, control, or common component should not cause a loss of supply to the common system.*

**I. Alarms:** At a minimum, a general fault signal and critical fault signal to the ARF monitoring system (where available) or to other approved arrangement that is capable of providing local ARF indication and remote notification to responsible personnel for critical alerts shall be provided. In addition, presence of a general fault and critical fault shall alert to the building automation system (BAS) or other program approved secondary alert point.

1. The configuration shall facilitate local audible and/or visual alarms (as required by the program) to indicate the presence of a fault, and remote, two-point (either general or detailed) alerts, along with the indication of the presence of a critical fault. The remote alerts shall operate upon alarm panel malfunction, local PLC disablement, or system power loss.
2. Critical alerts shall include any emergency condition where failure to respond or immediately correct could pose injury to animals, loss of research, or significant damage.
3. PLCs/controls shall include non-volatile memory. Emergency faults shall signal a critical alert whether or not the system primary PLC is operational.
4. The alarm configuration and associated fault indication and response sequence shall be as per the program requirements.

**Rationale:** *Local alarms at the system PLC can provide specific indication of the fault condition. Critical fault is transmitted to at least two program-designated staff to ensure notification.*

5. The performance of all significant components (e.g., RO system, UV disinfection, flow proportion/residual disinfectant injection status, rack flood alarms, system flow/pressure, temperature, water supply failure, tank level, and other major fault conditions that could be considered critical or directly lead to a critical fault shall be automatically monitored. Changes to critical operating, alert, and record parameters shall require at least a two level supervisory passcode.

**J. Disinfectant Residual/Additive Control and Monitoring:** Disinfectant residual/additives' rate/quantity control and monitoring is required. Where other additive use is authorized, similar reliable arrangements to those described for disinfectants shall be provided to ensure control and monitoring of additive levels.

**K. Proportioner/Additive Injection System:** The proportioner/additive injection system shall be located downstream of any system treatment that could affect efficacy or required water quality and shall be arranged to inject into the system based on actual makeup flow or other valid parameter. For chemical injection, at least two monitoring processes are required.

*Rationale: Each proportioner/injection system must account for actual makeup water presence in the system without assuming the reagent has been consumed.*

**L. Sampling Points:** The system shall be provided with sampling points from which product water may be readily taken to verify quality and proper treatment component operation. At a minimum, such sampling points shall be located at the beginning and end of distribution. In the case of recirculating arrangements, the main line sampling points shall be after all treatment equipment but prior to the first outlet, on the common return main from the system, located within the room housing the production system or storage tank, and prior to passing through any UV, storage tank, or other treatment components.

**M. Sampling Valves:** Sampling valves shall be configured with minimal dead-leg, be accessible, designed and suitably located for representative sample use, and shall have a discharge port small enough to achieve a laminar, full cross sectional area flow stream at a flow rate of 1 lpm (0.25 gpm).

**N. Maintenance:** Tanks, pumps, controls, and components shall be arranged to permit individual shutdown and isolation for maintenance while maintaining the balance of the system in continuous operation.

## 12.2.3 Barrier Facilities

**A. Barrier Facility Areas:** ADW services to barrier facility areas shall be clearly designated on drawings for review and approval.

**B. Specific-Pathogen Free, Low Microbial, Sterile, and Similar Applications:** Specific-pathogen free (SPF) and similar applications may require low microbial or sterile drinking water and shall not be piped from a common ADW distribution system without written approval of the NIH and the program manager. In general, the ADW for such spaces requires potable water that has been treated with carbon, RO, 254 nm UV, and micro-filtration, shall be maintained at very low levels of TOC or with approved disinfectant residuals, or where sterility is required shall subsequently be autoclaved in pure-steam fed autoclaves (coordinate with other disciplines to ensure suitable steam and appropriate equipment). TOC levels throughout the entire system must be less than 5ppb unless water is autoclaved to minimize microbial growth or maintained with residual disinfectant and automatic flushing. Unless otherwise approved by the program, gnotobiotic and germ free applications require sterile water that shall either be prepackaged sterile water, or produced as indicated above and then pure steam autoclaved with suitable packaging/handling.

*Rationale: Where water is autoclaved, pure steam must be utilized to prevent the drinking water from becoming contaminated during autoclaving (due to the quality of the steam and potential of exposure).*

**C. Piping to SPF Areas:** Piping of ADW to SPF areas (if permitted) requires a dedicated system arrangement for each segregation zone unless otherwise approved by the program management. Such systems must be located within the approved, controlled area.

**D. Cross-Contamination Protection:** Systems shall not circulate or serpentine from a non-SPF program area into a SPF program space. Circulation back to the discharge side of the production system is unacceptable.

**Rationale:** Unless other arrangements are specifically approved, returns must go back to the source for reprocessing to prevent inducing system wide contamination.

## 12.2.4 Microbial Control

**A. Control Parameters:** Provisions to control potential pathogenic microorganisms and biofilms shall be addressed in the design of ADW systems. The required microbial control provisions shall be stated in the BOD documents. Microbial control and monitoring shall occur from initial wetting through operational turnover to prevent uncontrolled biofilms.

**Rationale:** Microbial contamination and biofilms can proliferate within ADW systems and ultimately pose risk to research and animal health. Microbial control in ADW systems is a required component of ensuring potable water and complying with Public Health Service (PHS) policy requirements. Control of pathogens once substantial biofilms have established can be difficult and pose risks. Acceptable microbial qualities can vary from application to application; however, in all cases must meet the standards of potable water per the SDWA and control potential pathogens.

**B. Proportioner/Injection:** Each ADW system shall be provided with a proportioner/or other suitable chemical injection system to facilitate normal water treatment and maintenance of approved disinfectant residual, except where other approved non-chemical microbial control methods are utilized. The injector/proportioner shall introduce approved chemicals into a monitored buffer tank arrangement, include appropriate fail-safes to control operation and prevent over dosage (including under power failure, siphonage, or other conditions), and regardless of ADW system pressure or flow status. A static mixer or other means shall be provided to ensure homogeneity. A sampling port is required immediately downstream of the injection location prior to distribution. Metering type injection pumps with feedwater sensor override and a flow control valve shall be provided and shall be redundant. The injection arrangement shall

be on the feed to the storage tank(s) prior to distribution but downstream of the RO system, and configured to protect the RO membrane from chemical damage.

1. ADW shall be provided with appropriate levels of residual chlorination (only with water pH above 5.0) using USP or NSF-60 grade chlorine bleach, usually to achieve 0.5–1.0 mg/L free chlorine at the remote end of the system (starting with 2–3 mg/L total chlorine at the source). Alternatively, NSF-60 chlorine dioxide drinking water additive shall be applied at the water storage tank, residual levels should be below 0.5 mg/L (typically 0.3 mg/L) dependent on system design and TOC. In some cases ADW produced by RO may alternatively be acidified (with USP or NSF-60 grade sulfuric or hydrochloric acid), typically to a pH of 2.5–3.0 to reduce microbial activity, and with close microbial control monitoring throughout the system operating life, however. Residual chlorine or chlorine dioxide use is required for efficacy, unless determined unacceptable by the program management.
2. Maximum system disinfectant levels shall not be higher than as approved by the program veterinarian. Individual species and research needs may require lower limits than acceptable per SDWA. Generally, chlorine levels above 2–3 mg/L are undesirable as they can be corrosive to piping and the SDWA potable water maximum limits for chlorine are currently 4 mg/L and SDWA maximum for chlorine dioxide is 0.8 mg/L. Where chlorine or chlorine dioxide systems are utilized, monitoring of redox potential is recommended to ensure efficacy as well as monitoring of high chlorine/chlorine dioxide levels to prevent over dosage.
3. Chlorination shall not be used in conjunction with acidic waters (and acidification shall not be used with chlorinated waters, including municipal potable water) due to potential release of chlorine gas or toxic byproducts. All chemical injection processes shall consider the potential of disinfection byproducts or other induced contamination. Oxidizing disinfectants shall not be added to potable water without first controlling organics and existing chemicals (e.g., carbon plus RO or nanofiltration).



**Rationale:** Chlorine should only be added to waters with a stable pH between approximately 6 and 8 (ideally between 6.5 and 7.5). Water chemistry can be influenced by treatment methods and additives to sometimes result in unacceptable byproducts. Municipal waters are subject to variability which can cause unintended contamination. Chlorine dioxide levels of 0.3–0.5 mg/L apply for properly designed systems. Higher levels may be required for existing systems (up to 0.8 mg/L); however, shall not result in exceeding disinfection byproduct requirements, safe limits for the research model, or exceeding potable requirements.

4. A sampling port shall be provided at the injection station, immediately downstream of any mixing or blend apparatus but prior to distribution to rooms.
5. The use of redundant (alternating), monitored injection pump arrangements or at a minimum automatic monitoring is recommended.

**C. Additive Rates/Concentration:** Additive rates and concentration shall be directly controlled and arranged with adequate fail-safes to protect the system from over dosing. Settings of controls shall be protected from tampering and accidental adjustment. Supervisory level access shall be required to change setpoints and shall be automatically logged (audit trail required).

**D. Emergency Isolation Valve:** An emergency isolation valve or other positive-stop arrangement shall be provided to facilitate immediate stop of chemical dosage.

**E. Sensors and Monitoring:** EPA or ASTM accepted methods of sufficient accuracy and reliability concerning system water conductivity, quality, and flow conditions shall be used. Automatic monitoring and control arrangements shall address both low and high level limits. ORP and pH sensor (where used) and control instrumentation shall be selected for fluid conductivity and may be with or without potassium chloride buffer, depending on the sensor. Such sensors shall be arranged in a side stream loop at remote end of system, within a manufacturer approved flow cell arrangement and shall include pressure and flow control for the side stream to ensure constant stability of flow through sensor. The

flow cell should typically be grounded. For post-RO applications, the guidance of ASTM D5128 shall be followed. Maintenance free (disposable) sensors shall be selected and shall not require calibration or service more frequently than monthly.

**F. Chlorine Monitoring:** The preferred method where chlorine or liquid chlorine dioxide is utilized (unless otherwise requested by the program or more accurate technology is made available) is through the use of proportioner metering control of the injection rate to makeup water (at feed to the water storage tank) supplemented with the remote end of system ORP monitoring, and routine manual use of a portable-type N, N-diethyl-p-phenylenediamine (DPD) photometer. Free chlorine type monitors, including amperometric methods may be used only if designed for use with the system water quality/conductivity and so validated. ORP monitoring at the tank is acceptable for non-circulating chlorine dioxide systems with a sufficient routine microbial monitoring plan and proportional injection metering. Calibrated chlorine dioxide sensors may also be used, but shall not be used in lieu of dosage metering.

ORP (redox) monitoring is recommended to supplement manual monitoring and proportioning control but shall not override the high limit level set point of the injector or pH and maximum chlorine level verifications.

**G. Acidification and pH Monitoring:** The preferred method where acidification is utilized is through use of proportioner/metering control of injection rate to makeup water (at feed to the water storage tank) supplemented with the remote end of system pH monitoring and routine manual use of a portable type photometer.

pH monitoring shall not override the high limit set point of the injector.

**Rationale:** ORP and pH monitors can provide effective monitoring to ensure sufficient disinfectant residual is maintained; however, they must not be relied upon for direct automatic dosing control or for establishment of high limits due to the potential of over dosage. Color comparator strips are less accurate than calibrated DPD photometer monitoring and should only be used with chlorine residual less than 2 mg/L. Ideally, chlorine based systems should utilize ORP

*for low limit alert/information and the set point concentration of the proportioner as the high limit, with periodic DPD photometer manual checks.*

**H. Point of Use Microfilters:** Point of use and bottle-filler microfiltration may be applied with systems that maintain chlorine residual and provided required replacement frequency (typically 30 to 90 days) is maintained.

***Rationale:** Appropriate types of microfiltration can be helpful in resolving microbial issues; however, without sufficient maintenance, microbial issues upstream of filters may occur and eventually grow through.*

**I. Sanitary Construction Criteria:** Good practices shall be followed to minimize dead-legs and to ensure complete flushing of each segment. Where piping systems do not operate with constant presence of adequate disinfectant residual, systems shall be designed in accordance with requirements for high purity water distribution (see [Section 12.1 High Purity Water Systems](#)). For all systems, the use of sanitary type instruments and sanitary instrument fittings and similar design practices consistent with sanitary systems shall be followed. Best practices of sanitary standards e.g., ASME Bioprocess Equipment Standard (BPE), 3A Sanitary, or similar methods are recommended and shall be applied in selection of distribution system components to the extent reasonably practical.

**J. Chemical Free Operation:** The use of NSF-60 chlorine dioxide applied at the tank combined with systems designed to provide very low (<10 ppb TOC) levels should be used where facilities require operation at very low chemical disinfectant residual. Where piped distribution of water must be free of disinfectant residual, approval is required. Justification shall include a microbial control and monitoring plan. Such systems shall be designed to consistently achieve 0 CFU/liter (none detected) viable microbial values and shall be routinely validated. The ADW systems for such applications shall maintain less than 5 to 10 ppb TOC throughout the distribution system, and continuous recirculation through at least 100,000  $\mu\text{Ws}/\text{cm}$  UV end of lamp life (EOLL) low-pressure 254 UV and provided with an approved

microfilter/ultrafilter located immediately prior to distribution. Two pass RO is typically required for such applications.

1. The arrangement shall be designed as an ultra-pure water system with 4D maximum deadlegs, zero static valves and 0.30 m/s (1 fps) velocity maintained under all conditions. Oxidizing UV at 185 nm of appropriate fluence (typically at least 300,000  $\mu\text{Ws}/\text{cm}^2$  UV EOLL) may be used for final low-level TOC polishing only after completion of comprehensive water analysis, including review of organics. On-line TOC monitoring is required. System distribution materials shall be autogenous orbital welded, electropolished, and passivated 316L stainless with a maximum 15 Ra, except that other materials and joints of equivalent sanitary, crevice-free quality, including IR fusion, may be used subject to approval. Contamination induced from mouth contact shall be addressed (point of use microfiltration may be required, and an air gap shall be provided in the dispense arrangement where possible).
2. Microbial control for water within storage tanks is required. Carbon media shall not be applied downstream of the RO system. The use of central ozonation or high temperature storage is not acceptable in itself due to potential of safety and reliability issues that require project specific evaluation to mitigate risks and ensure long term efficacy.
3. Systems shall recirculate back through the treatment train (at a minimum back through the treated storage tank, UV, and microfilter/ultrafiltration), except that recirculation of water through the racks back to the system is not acceptable. Flushing shall be provided for racks (to drain) at least every 12 hours.
4. Routine systems sanitization plans shall be determined and accounted for during design, documented, and approved by the program. Refer to [Section 12.1 High Purity Water Systems](#) for general guidance as may be required for design of chemical-free systems.



***Rationale:** Some programs may mandate disinfectant free water at quantities or automation that is infeasible to provide through portable or autoclave methods. Such systems may require sanitization on a frequent basis. Approaches may include high temperature distribution with fail-safe dispense point cooling (e.g., to a bottle filler), central ozonated systems constructed to beverage drinking water standards, and low TOC RO water; all designed similar to ultra-high purity (UHP) systems. System design and operation must prevent uncontrolled biofilm. Oxidation of TOC alone (as opposed to TOC polishing) is not acceptable due to potential formation of hydrogen peroxide or toxic byproducts.*

**K. Microfiltration:** Microfiltration or ultrafiltration shall be provided downstream of UV disinfectors to reduce dead organic matter as a nutrient source that may promote microbial growth and biofilms and to remove particles e.g., microbial matter. Effective tight filtration is mandatory for chemical free systems.

**L. Continuous Circulation:** System designs shall avoid dead-legs and potential stagnancy to the maximum extent possible. Short branches to cage racks, rooms, and other lines that are routinely used and flushed (at least once every 12 hours) to achieve water turnover are not considered dead-legs in flushing systems. Where disinfectant residuals are not maintained, dead-leg length in the distribution system shall be avoided, but in no case exceed 4 pipe diameters in length.

**M. Disinfection Planning:** Systems shall be designed to accommodate routine disinfection and flushing. The provisions shall be outlined in the BOD. System design and materials shall be compatible with the following flushing method and at least one of the following sanitization methods:

- 1. Flushing Method:** Routine flushing operations by elevating system velocity to at least 1.52–1.83 m/s (5–6 fps) and flushing through open pipe ends can reduce sanitization frequencies and be beneficial during the sanitization process. This can typically be accomplished by bringing both distribution pumps online simultaneously while maintaining a systematic order of flushing.

- 2. Disinfection Chlorine Method:** Routine sanitization can be accomplished by disconnecting all racks and flushing with chlorine at 30–50 mg/L concentration (typically for 30 minutes to 2 hours), followed by complete flushing and manual sampling. Where severe biofilms are established, multiple sanitizations along with flushings may be required. Materials of construction must be considered.
- 3. Disinfection Peroxide Method:** Routine sanitization may also be accomplished by the use of proprietary peracetic acid/hydrogen peroxide solutions designed for use with purified water systems, typically at concentrations of 1–2 ppm for approximately 60 minutes, followed by complete flushing and manual sampling. If appropriate elastomers are selected (e.g., EPDM and silicone), such use can avoid damage to stainless steel piping associated with high chlorine levels.

***Rationale:** Piped ADW systems must be sanitized periodically and shall be designed to facilitate the control of biofilm and effective sanitizations and flushings. Significant disruption and labor expenditures are often required to facilitate routine maintenance and sanitizations and can be especially onerous where established biofilm issues must be mitigated. Chemical disinfectants (chemical sanitants) are typically utilized for routine sanitizations.*

**N. Disinfectant Flush Station:** Where piped ADW systems are provided, a disinfectant flush station shall be provided in the cage wash areas such that individual manifolds and hoses may be routinely disinfected by flushing with an appropriate sanitant to control potential for cross infection. The process must be monitored. Alternative means of periodic sanitization may be utilized as accepted and validated by the program.

**O. Bypasses:** Where a bypass is provided around any component, or where stagnancy could occur, such bypasses shall be configured to avoid dead-legs and fully drainable when not in use.

## 12.2.5 Distribution

**A. System Pressure:** System pressure shall be controlled by high quality automatic pressure-regulating valves, suitable for the pressure range and turndown ratio required, and fitted with means to automatically monitor the pressure setting. Upstream of pressure-reducing valves at the source makeup supply, pressure shall not be below 241 kPa (35 psig), and pressure upstream of zoning pressure regulators shall not be below 138 kPa (20 psig) or above 552 kPa (80 psig). Pressure control for the distribution system to rooms/use points shall be maintained specific to the animal species and nozzle type. Individual regulators at each rack/use point in lieu of zoning is not acceptable.

*Rationale: Excess pressure can prevent operation of drinking water nozzles.*

**B. Room Level Zoning:** Dedicated pressure control stations shall be provided for each room to permit program flexibility, except that a single pressure control station (PCS) may serve multiple rooms housing the same species within the same suite where approved by program management.

**C. Building Level Zoning:** Where a production system serves more than one floor, building, or building wing, each floor or other major area shall be separately zoned with independent horizontal supply and return main(s) provided for each floor and building area. The piping system distribution on each floor and building wing shall be independent of other floors or building wings at least to the connection with the main supply and return riser. Refer to [Section 8.1 Plumbing General Requirements](#). Preapproval by all affected programs is required for any shared system arrangements.

**D. Distribution Concepts:** Distribution systems shall be arranged to ensure either: (1) continuous circulating flow of the supply and return piping mains with supplemental flushing of individual rack manifolds or room branch lines, or (2) to provide complete automated flushing of the entire system including individual rack manifolds. Circulation is not a substitute for maintaining disinfectant residual.

**E. Contamination Protection, Rack Manifolds:** After the supply drop to individual rack manifolds, the manifold shall flush to a room or individual manifold flush connection so that there is no distribution of water past drinking water nozzles from one rack manifold to the supply of the next manifold or room.

**F. Free Draining, Stagnancy Protection:** Flushing arrangements and associated piping shall be organized to ensure complete flushing without standing water remaining on the downstream (non-pressurized) side of the solenoid flush valve to the greatest extent possible. After the flush valve, lines shall be sloped to drain at 2% or greater.

**G. Crossing Biosafety Levels, Cross-Contamination Control:** Systems shall not serve across higher biosafety levels. Dependent upon application or risk, appropriate means of cross-contamination control shall be considered.

**H. Fresh Water Turnover and Routine Flushing Velocity:** Systems shall be arranged to ensure fresh water system turnover. System flush volume/duration shall automatically turnover the entire piping contents of each section of the system at least twice daily at a velocity of at least 0.61–0.91 m/s (2–3 fps).

**I. Pipe and Pump Sizing:** In sizing piping and pumps for circulating systems a minimum velocity of 0.30 m/s (1 fps) is required; however, not less than 0.61 m/s (2 fps) for stainless steel, including under conditions of circulation and simultaneous flushing. Maximum velocity for all systems shall not exceed 1.52 m/s (5 fps) for plastic or 2.44 m/s (8 fps) for stainless. Flushing type systems shall be sized based on requirements for routine flushing velocity. Avoid oversizing systems.

**J. Redundant/Alternating Equipment:** Distribution equipment (e.g., pumps) required to maintain system flow shall be redundant and alternating at least every 12 hours or maintained in constant operation. Flushing pressures shall not pose hazards to animals.

**K. Supply to Demand Ratio:** Pumps and piping shall be sized and calculations shall demonstrate that sufficient flow rate is provided to achieve a supply to demand ratio (SDR) of at least 1.7:1 under all demand conditions and variations of total connected rack load, including during flushing.

***Rationale:** Provision of adequate flow and maintenance of positive pressure throughout the system under all conditions are key elements to avoiding backflow or inducing system contamination. 1.7:1 is based upon a minimum criteria of 1.5:1, plus the mandatory 20% overage required for distribution mains and primary equipment sizing per DRM requirements.*

**L. Distribution Pump Operation:** Systems shall be arranged such that both the primary and redundant pump may be brought online simultaneously and selected to achieve an elevated flushing velocity of at least 0.91 m/s (3 fps), but preferably 1.52–1.83 m/s (5–6 fps) to the extent possible for periodic, supervised flushing. Under such conditions, maximum velocities anywhere in the system shall not exceed 2.44 m/s (8 fps).

**M. Automatic Flushing or Circulating Distribution Type:** Systems shall be automatic flushing or circulated type with supplemental flushing as follows:

**1. Automatic Flushing Distribution Systems:**

Central production systems shall distribute ADW through a horizontal serpentine distribution arrangement to each holding room, or through a horizontal central supply main with an individual branch to each holding room, provided the arrangement maintains required minimum flow velocity at all times. Systems that rely upon flushings are only acceptable for applications that maintain residual disinfectant. Refer to [Section 12.2.4 Microbial Control](#). Automatic flushing systems shall comply with the following:

- a. Multiple zones shall be provided as per the program requirements or as appropriate for varying species.
- b. The distribution main within each room shall individually connect to each rack manifold. The ends of each manifold shall automatically flush through a plumbing code compliant fixed air gap to a sink, drain/trough, or individually connect to a collector manifold discharging through a fixed air gap to an approved location.
- c. Reverse “S-” type manifolds (with supply

from the bottom) are preferable to allow complete flushing and removal of air; however, alternative equivalent arrangements may be utilized as approved by the program.

- d. Dedicated PRV stations are required for each room to permit program flexibility, except that, a single PRV station (single zone) may serve up to six rooms of the same type within the same program and where approved by the user group provided this has been arranged to ensure positive flushing.

**2. Circulating Distribution Systems:**

Piping arrangements shall distribute through a horizontal serpentine arrangement from one room to the next or through a flow verified and properly balanced horizontal supply and parallel return piping mains system (e.g., a horizontal direct return or reverse return mains arrangement, where a single common supply feed is provided and extended to each room with return back to single or multiple return mains). Each return branch shall be fitted with a flow meter and balancing device to verify proper flow, and with the exception of serpentine systems or systems with individual room flush, a single supply and return connection shall be provided for each room. Circulated distribution systems shall comply with the following:

- a. Circulating systems shall be arranged to achieve complete and constant (24/7) circulation of supply mains and through all returns. Circulation systems shall ensure that storage tank contents are turned over at least once every two hours.
- b. The recirculation shall return back through the inlet side of the 254 nm UV and microfilter or ultrafilter after passing through the storage tank.
- c. Drops to individual rack manifolds shall connect to an “S” type rack manifold or similar arrangement that flushes completely and is not recirculated. The end of each rack manifold shall be automatically flushed.
- d. Where pressure zoning is to be provided,

dedicated PRV stations are required for each room to permit program flexibility, except that a single PRV station may serve up to six rooms of the same type within the same program where approved by the user group.

- e. Forced circulation shall not occur through PRV stations in any closed loop configuration (e.g., between the high pressure and low pressure sides of the PRV). Once pressure is reduced, it shall not be blended back into a higher pressure system, and the use of attempts to compensate (e.g., orifice plates, flow control valves, remote control sensors) are unacceptable. Where multiple zones must return to the tank, each return shall be direct to a tank port located above the highest tank water line in an atmospheric vented storage tank or to a common line at the main tank return (sized to preclude backpressure). Vent and return port placement shall be coordinated to protect the hydrophobic vent filter from water blockage.
- f. A means of controlling flow for each return shall be provided. Engineered flow restrictor tubes or calibrated orifices may be provided where the full load of each room has been considered in the system design. Where manual valves are utilized, they shall include a memory-set locking feature/position indicator. Manually adjustable valves shall not be located where subject to tampering. Required set points shall be recorded on the valve and also marked in O&M documentation.
- g. The return from each building wing, from each floor, and also (or in the case of single area systems) the main return at the end of distribution but prior to the back-pressure regulator (where provided) shall include a manually adjustable flow control valve and an electronic flow meter with visual indication and remote flow monitoring through the use of a non-contact type flow meter.

**N. Untreated Potable Distribution Systems:** Where such systems are permitted (typically for large/outdoor animals) systems shall be designed as an automatic flushing

type, maintained with sufficient residual disinfectant of same type as in the incoming feed water supply, and shall terminate with an air gap to any troughs or other arrangement to protect from cross-contamination. ASSE 1013 backflow protection and a break tank arrangement with repressurization pump is required. Valves and nozzles must be suitable for scaling properties of the water. All segments of the system shall be configured to achieve automatic turnover of entire pipe contents at least twice per day.

**O. Valving Independence:** System controls or valving arrangements shall permit flushing processes to be individually activated or disabled by at least room level to facilitate system repair without necessitating total system shutdown. Each zone shall be provided with valving to facilitate independent isolation without affecting the rest of the system.

**P. Temperature Control:** Water temperature at any point in the distribution system shall be program driven. The maximum temperature of all systems shall be controlled (typically with automatic flushing) and monitored. Distribution should be maintained at 15.5–18.3°C (60–65°F) where acceptable to the program management, especially for services to large animals, as this temperature range may retard microbial growth. Minimum temperature shall consider condensation issues. The A/E shall consider all heat sources, including from any pumped circulation and UV in determining temperature control requirements. The A/E shall review municipal seasonal temperature records to ensure at all times water temperature will be suitable for the application. Where required a double-wall sanitary heat exchanger shall be provided to cool the system.

**Q. Horizontal Piping:** Horizontal piping shall be mounted at least 300 mm (12 in.) above rack height or be protected to minimize potential for damage from animals or mechanical impact. The use of plastic mounting clips for piping shall be avoided; however, plastic-lined clamps may be required for certain plastic piping.

*Rationale: Plastic mounting clips have been subject to premature breakage from rack movements, impact, cleaning, and wear.*

**R. Rack Flood Prevention:** The A/E shall review rack

flood prevention requirements with each small animal program. Special ADW nozzles, anti-flood, or flow alert sensors and controls may be required where automated systems are provided.

## 12.2.6 Disaster Mitigation

**A. System Failures:** Ensure that, even with failure of primary equipment and incoming building potable water, drinking water supply to animals will not be compromised.

**B. Redundancy:** Redundant water conditioning components or other provisions shall be provided. Address in the project's BOD.

**C. Backup/Emergency Supply:** Continuity of undisturbed water supply is mandatory and consultation with the user group in consideration of site-specific risks is required. Provisions to ensure an emergency backup supply, preserve its quality, and to minimize risk of loss of service are required and shall be evaluated on a project specific basis. An emergency potable water bypass backed by a potable water emergency remote supply connection point on the main building potable water supply should be considered. Reliance on building water supplies alone is not sufficient for backup.

**D. Major Fault Alert/Loss of Water Supply:** Automatic monitoring is required to provide the most immediate alert for system malfunction.

## 12.2.7 Materials

**A. Minimum Materials Quality:** All wetted materials, sealants, and installation methods shall be selected to ensure compliance as 21 CFR approved for food contact. Proper certifications of compliance and/or listings to ANSI/NSF-61, NSF-14, 21 CFR food contact materials provisions, or USP Class V or Class VI are acceptable evidence of satisfactory materials to meet this requirement.

1. The A/E shall specify that methods utilized in

constructing and testing systems (including tools) be sufficiently clean to prevent inducing unacceptable contaminants.

2. Elastomers shall be reviewed for compatibility with selected sanitization methods. Generally, only 21 CFR 177.2600 FDA-, NSF-61, or alternatively USP Class V- or Class VI- (or equivalent ISO 10933-) compliant grades of ethylene propylene diene monomer (EPDM), Viton/FKM, polytetrafluoroethylene (PTFE), silicone, or other approved fluoroelastomers may be utilized. Natural rubber shall not be utilized at any point in the system. The A/E shall specify certification of elastomers ensure an appropriate matching of elastomers to the piping material selected to ensure compatibility with system sanitization and operating methods.

*Rationale: Natural rubber shall not be used in ADW systems as it serves as a nutrient for bacteria. FDA food-contact-compliant materials are required due to the wide range of variation in elastomer formulations and processing, some of which include lead and leachable chemicals, and can induce a variety of contaminants.*

**B. Contamination Prevention:** All materials shall be stored, handled, installed, and flushed or sanitized as required to prevent unacceptable levels of contamination.

**C. Stainless Steel:** At the NIH, the required ADW distribution system material for most systems is electropolished type 316/316 L stainless steel tubing with either clean/sanitary joints or 316 L electropolished with orbital weld joints and post weld passivation by a qualified firm specializing in high purity, food industry, or biopharmaceutical systems. Stainless steel is acceptable for use with sulfuric acid.

1. Stainless steel is not recommended for systems that will be acidified with hydrochloric acid. Hydrochloric acid is often preferred where acidification is being provided and shall be verified with the program management.
2. Alternative plastics (where acidification is



provided) shall be used as follows:

- a. For systems maintaining residual disinfectant, stress crack resistant grades of high density polyethylene or polyvinylidene fluoride (PVDF) pipe or tubing may be used. Polypropylene should not be used where bleach will be utilized as a sanitant or where elevated chlorine or chlorine dioxide residual will be maintained. Non-translucent grades that are NSF-61, 21 CFR 177.1520, or CFR 177.2510 compliant shall be used. Where systems maintain residual disinfectant, socket fusion is permissible, though IR fusion is recommended. Where systems do not maintain residual disinfectant, joints shall be IR fusion type; except that, not more than 15% of joints may be conventional butt fusion where required due to site conditions and the use of clean and bagged pipe and fittings is recommended. Approved sanitary joint mechanical fittings (e.g., PVDF or polypropylene sanitary ferrule or sanitary flare systems) may also be permitted where such fittings are exposed.
- b. Polyvinyl chloride (PVC) materials (including CPVC) are unacceptable.

***Rationale:** 316/316 L stainless steel has been proven through extensive applications and is less susceptible to breakage than plastic materials, but may not be appropriate for some applications (e.g., subject to high chlorine concentrations or hydrochloric acid). PVC/CPVC joints typically have pockets that may impact sanitary conditions, solvent cements can emit high TOC levels (which serve as nutrients for microbes), high particles (which impact filters), and the piping material can become brittle and subject to breakage.*

**D. Joints:** System piping joints shall be of a clean or sanitary type, smooth, and with minimal potential fouling spaces. Sanitary mechanical joints are acceptable for exposed construction which is not subject to excessive risk. Sanitary joint technologies, including gas tungsten arc welding (GTAW) orbital weld type joints and IR fusion are required to minimize crevices and pockets,

potential for microbiologically influenced corrosion, and is preferred for reliability and performance. Crevice free type fusion is not required.

**E. Chemical Resistance:** Tanks, piping, distribution systems, and all other wetted components shall be resistant to system cleaners, chemical sanitants, and not compromise water quality.

***Rationale:** The most commonly utilized sanitants are hydrogen peroxide, peracetic acid, chlorine, and proprietary combinations. Some systems may operate routinely with elevated chlorine or acidification.*

**F. Valves:** Valves shall be constructed of 316 L stainless steel, 21 CFR 177.1520 or 21 CFR 177.2510 compliant plastic, and shall be provided with approved FDA compliant elastomers.

Within the distribution system of systems that operate without continuous disinfectant residual, the use of diaphragm valves are required. For systems that operate with sufficient disinfectant residual, stainless steel or compatible plastic ball valves (to match system material) may be utilized.

**G. Filters:** Commercial grade filter housings capable of maximum system surge pressures of 316 L stainless steel construction, with PP, PVDF, PES, or PTFE filter media (as compatible with the system sanitant) are required. Where plastic housings are approved they shall be rated 1,034 kPa (150 psig) (minimum), and shall be opaque or wrapped to limit light infiltration. 316/316 L stainless steel housings shall be used where available. Filter elements shall at a minimum be approved for potable water system applications. Filters on the downstream side of the RO system shall be free of binders, adhesives, surfactants, or coatings and shall not require pre-wetting. Filters shall be of compatible materials and elastomers and 21 CFR compliant for food contact. The A/E shall specify the required filter type and performance for the required particle capture. Filters shall incorporate O-ring type (not flat gasket) end seals. Food and beverage, semiconductor/microelectronics grade, and biopharmaceutical grade filters may be utilized provided they meet the requirements of this section. String-wound filters are unacceptable. All liquid system filter housings shall include a drain to prevent contamination



during filter element changes and a high point air vent (both on the dirty side).

1. Tank vent filters shall be in accordance with requirements of [Section 12.1 High Purity Water Systems](#).
2. The post-RO/post-UV filters shall be N + 1 (in parallel) and of tight design e.g., pharmaceutical or ultrapure water (UPW particle type). Filters shall be hydrophilic PTFE, PES, or PVDF membrane material, single or double layer membrane type with no wetting requirements. Further, they shall be non-shedding, with low ionic, single digit TOC extractables required for chemical free systems and shall be rated for an efficiency of greater than or equal to 90% at 0.1 µm. Hydrophilic membrane filters providing 3 log reduction in conformance with these requirements, as well as hydrophilic membrane filters providing 6 log 0.2 µm per ASTM F838 may be utilized. Filters shall be 100% integrity tested and shall be compliant per 21 CFR for food contact. Seal designs shall be Type 222 or 226 style, with or without fin, and shall be Code 2, 3, 7, or 8 style as appropriate. Housings shall be sanitary type to hold filter elements a minimum 254 mm (10 in.) in length. Multi-element housings may be used as required; however, N + 1 redundancy requires at least two housings. Users shall be made aware that final water system filters (where used) must be changed every 30 to 60 days regardless of pressure differential. This same criteria applies where point of use filters are used. Filter assemblies may be disposable or element-in-housing type.

A manufacturer recommended graded pre-filtration membrane shall be provided where upstream RO, nanofiltration, or ultrafiltration is not present.

***Rationale:** Stringent specification for the primary filter is significant to maintaining microbial control and low particle count. These filters should not be used without upstream RO due to potential for plugging.*

**H. System Materials:** All wetted system materials

(piping, tanks, etc.) shall be opaque and inert to prevent unacceptable leaching of contaminants. Where non-opaque or non-UV resistant materials are utilized, such materials must be encased or shielded in compatible, durable, seamless jacketing (typically 20 to 30 mil plasticizer free PVC or PP pipe wrap). Material selection within ARFs shall maintain sanitary requirements, cleanability, and pest-control features. Metal components used within the purified ADW wetted system shall be type 316 L stainless steel only.

***Rationale:** Appropriate shielding materials and avoidance of translucent materials protect systems from UV light infiltration, which may damage some materials and promote algae.*

**I. RO System:** RO systems shall be of beverage production/commercial grade systems with TFC (polyamide) high rejection membranes. No PVC downstream of carbon pretreatment. Chemical or metal impregnated spaces shall not be used. Motors shall be wash down duty if unit is located in cage wash, otherwise no less than TEFC. High pressure pump(s) shall be stainless, including the impeller. Distance between the RO permeate source and storage tank shall be minimized. Instrumentation/monitoring to be per requirements of this section. The use of RO process design software is required unless comprehensive RO membrane process analysis has been provided. Membranes shall be selected to achieve minimization of organics (TOC).

**J. Pumps:** Pumps downstream of RO systems shall be in conformance with [Section 12.1 High Purity Water Systems](#). Where systems maintain residual disinfectant that may be corrosive to stainless steel, sanitary fluoropolymer lined centrifugal pumps should be utilized. Where no RO is utilized, pumps shall be at least as approved for potable water and compatible with system disinfectants, typically 316/316 L stainless steel. Sanitary pumps may be waived for systems with disinfectant residual where pumps are maintained online.

**K. Tanks:** Tanks shall be in accordance with [Section 12.1 High Purity Water Systems](#). Tanks shall be gas-tight and have a sanitary rupture disk; except that, gas-tight tanks and a rupture disk are not required where tanks are maintained with residual disinfectant. NSF-61 and 21 CFR 177.1520 compliant tanks may also be

used where tanks are maintained with residual disinfectant and tanks are of polypropylene or linear high density polyethylene construction. Tank material shall be confirmed compatible with system sanitants and disinfectant residual concentrations. Tank bottoms shall be conical or dished with a bottom outlet to the system. Tanks shall be opaque or opaque jacketed with compatible material. Tank stands shall be non-corroding.

1. Tank level sensors shall be pressure or radar type.
2. Where residual disinfectant (chlorination or chlorine dioxide) is maintained in the tank, tanks with a tight-closing lid and P-trap type overflow or other effective sanitary overflow configuration may be utilized in lieu of the rupture disk and airtight design. The control system provides a controlled overflow to change out trap fluid at regular intervals (at least weekly) without activating high level alarm. Mechanical/fouling components, including ball-checks are not permitted, including in the overflow.
3. The tank shall be filtered and vented to maintain atmospheric pressure.
4. Where water is stored in tanks that do not continuously maintain required disinfectant residual, tanks shall be provided with a low pressure sensitive sanitary type rupture disk burst indicator in lieu of tank overflows. The rupture disk shall be piped to drain. The rupture disk shall be selected for maximum tank pressure rating and to prevent false tripping (including under conditions of sudden tank level changes). Tank construction and rupture disk shall comply with [Section 12.1.5.1 Materials Selection and Miscellaneous Component Criteria](#).
5. Burst indicators shall be provided for tanks with rupture disks and shall signal an alarm condition to the system PLC. Ensure vent and filter sizing is adequate to maintain atmospheric pressure with an arrangement to preclude vent blockage (heat trace type filter housing as required to prevent moisture from blocking the hydrophobic vent filter).

*Rationale: These requirements help maintain*

*microbial control and prevent contamination. Overflows are a source of contamination and (with the exception of appropriately filtered air vents) tanks must be sealed for contaminant control.*

**L. Hydro-pneumatic/Bladder Tanks:** Where pressure tanks are required, the material of construction for water contact areas shall be corrosion resistant to the disinfectant quality of the system water. Interior coated steel tanks are unacceptable; however, 316 series stainless steel tanks may be utilized where compatible with system additives. Tanks shall include food contact diaphragm/bags/bladder. Copper, brass, or similar components or connection linings are not acceptable. Bladder tanks are not permitted for systems that do not maintain residual disinfectant.

*Rationale: Bladder tanks can be a source for stagnancy. Copper/bronze linings can leach into low ionic strength water systems and are typically not adequately corrosion resistant.*

**M. Hoses:** Flexible PVC hoses shall be avoided as they contain significant plasticizers. Where hoses are required they shall be smooth interior bore non-contaminating type, fluoropolymer/fluoropolymer lined or of DRM approved system tubing materials, and rated for at least 1034 kPa (150 psi) working pressure. Cage rack/recoil hoses shall be chlorine and 60°C (180°F) temperature resistant, pressure rated, and shall not include natural rubber (typically PVDF/stainless).

**N. UV Disinfection Systems:** UV systems for disinfection shall be 254 nm low pressure type and provide a fluence of at least 60,000–100,000  $\mu\text{Ws}/\text{cm}^2$  UV new lamp and 30,000–50,000  $\mu\text{Ws}/\text{cm}^2$  at end of lamp life. Light traps are required for non-stainless piping. Comply with UV Systems General Requirements, 12.1.5.1.J. Redundancy is not required.

**O. Flushing Valves:** Automated flush valves shall be slow-close (anti-shock) type.

## 12.2.8 Startup and Verification

**A. Prior to Use:** Prior to use, the entire system shall be thoroughly flushed, commissioned, and disinfected with approved methods compatible with piping system materials. Delivered water quality shall be comprehensively tested by qualified labs.

1. Individual equipment, piping lines, and all outlets shall be thoroughly flushed prior to final occupancy, use, disinfection, or connection of racks. Upon the completion of flushing and testing, the system shall either be: (1) disinfected and maintained in operational status with residual disinfectant and periodic flushings, or (2) drained and dried (and then sanitized and put into use when ready).

**B. Startup/Extended Non-operation:** It is mandatory in starting up systems or while systems are non-operational for extended periods, that the system shall be either maintained with sufficient disinfectant residuals and periodic flushing or immediately drained, dried, and maintained to prevent contamination, corrosion, or damage to the system. If disinfectant residual is at potable water levels, complete flushing shall be at least every other day.

*Rationale: This requirement is mandatory from the time of initial fill and test through turnover for operation as it prevents the establishment of biofilm, corrosion (e.g., microbiologically influenced corrosion), and other system damage due to stagnant water.*

**C. Chemical Feed Verification:** Calibration and verification for correct set points and operation of proportioners/injection systems, flow meters, and other critical components is required and shall be verified post-installation (including verification of disinfectant levels both near the chemical injection site and at remote points in the system to verify minimum and maximum levels). An EPA or ASTM recognized method suitable for the application shall be utilized to verify proper operation.

**D. System Testing:** The A/E shall specify the initial water quality testing to occur as part of the facility commissioning or system acceptance phases and submit results to the PO; unless otherwise approved by the program management. Microbial testing as well as general water quality and disinfectant residual verification is required. Testing shall demonstrate system water quality to be potable utilizing methods suitable for the system water quality. pH shall be tested and adjusted prior to chlorination. A period of verification consisting of multiple tests conducted over not less than a three week period is required for systems that do not maintain disinfectant residual.

# Section 12.3

## Compressed Gas and Cryogenic Systems

---

### Contents

- 12.3.0 Introduction
- 12.3.1 General Design Requirements
- 12.3.2 Bulk Gas and Cryogenic Systems
- 12.3.3 Compressed Gas System Sizing, Components, and General Distribution Requirements
- 12.3.4 Compressed Air Systems, Additional Requirements
  - 12.3.4.1 Compressed Air Quality
  - 12.3.4.2 Compressed Air System Source Arrangement
  - 12.3.4.3 Compressed Air Equipment
  - 12.3.4.4 Central Lab Air System, Additional Requirements
  - 12.3.4.5 Control Air/Instrument Air Systems, Additional Requirements
  - 12.3.4.6 Pharmaceutical Air/Cleanroom Air, Additional Requirements
  - 12.3.4.7 Compressed Air Distribution
- 12.3.5 Supply Manifold Systems
- 12.3.6 CO<sub>2</sub> Lab Gas, Additional Requirements
- 12.3.7 Liquid and Gaseous Lab Nitrogen/Argon, Additional Requirements
- 12.3.8 Ultra-High Purity, Hazardous, and Specialty Gas

## 12.3.0 Introduction

This section addresses compressed gases and compressed gas generation equipment, cryogenic fluid systems and associated bulk supplies used for laboratory gas, control air, and specialized compressed fluid applications.

### 12.3.1 General Design Requirements

**A. Supply System Configuration and Capacity:** Supply systems shall consist of a cylinder, dewar, or bulk supply system, each with required appurtenances to deliver the process fluid under controlled conditions through a distribution system to each use point. Multiple buildings shall not share common supply systems. Systems shall be designed such that the primary, secondary, and any emergency reserve may each be taken offline, serviced, and replenished without causing any disruption or contamination of facility supply.

- 1. Primary Supply Capacity:** Central, bulk, and cryogenic systems shall provide for a minimum of 3 weeks consumption, plus 20% overage capacity.

Local/dedicated program area systems shall provide at least a 2 week consumption, plus 20% overage capacity. They shall be high pressure gas type wherever possible.

- 2. Secondary Supply Capacity and Type:** A secondary supply shall automatically supply the distribution system if the primary supply becomes exhausted or fails.

For central bulk cryogenic systems that include telemetry, at least 72 hours capacity and an additional 20% overage is required, unless the local resupply situation or program requirements dictate a greater capacity.

For local program areas, the reserve shall be at least 2 weeks capacity, plus 20% overage.

Where the primary supply is of 3 weeks or greater capacity, it is acceptable for the secondary supply to be sized at not less than 2 weeks demand plus 20%, provided that if the reserve is

accomplished with dual bank manifolds it must be fully automatic (not semi-automatic) type.

For all reserves supplying gaseous systems, at least 72 hours capacity with 20% overage shall be provided from high pressure gas cylinders. Where this is not possible (e.g., due to building constraints), at least 24 hours high pressure gas with 20% overage plus an independent in-building or at-building emergency reserve is required; the entire secondary supply (gaseous and cryogenic) shall be protected from losses including as may occur from evaporation.

The requirements for secondary supply capacity do not apply to in-lab point of use applications which shall be determined in accordance with program requirements.

The reserve shall be provided by a fully automatic, NFPA-99 style, dome loaded, high pressure gas manifold per [Section 12.3.5 Supply Manifold Systems](#). For applications fitted with an in-building or at-building independent emergency reserve, the secondary supply source may also utilize an NFPA-99, semi-automatic manifold provided it is analog type with dual primary dome loaded dual line regulators and individual bank pressure monitoring. The use of an automatic type manifold is required regardless of type of primary supply. The primary and secondary supply may be accomplished utilizing a shared automatic manifold.

- 3. In-Building Independent Emergency Reserve:** An automatically activated high pressure gas cylinder supplied emergency reserve, fully independent from other supply sources, and with a capacity of at least 24 hours consumption after including 20% overage, shall be provided for critical gaseous systems including CO<sub>2</sub> and any other system distributed building wide or distributed to significant program or other critical areas. The emergency reserve shall be located either in the facility or at the building exterior with no underground buried piping. The reserve shall be automatically monitored per this section.

The independent emergency reserve is not required for local high pressure gas fully



automatic manifold systems, provided each cylinder bank pressure is automatically monitored (upstream of the primary pressure regulators) and with no buried piping. Where a cryogenic bulk supply with no buried piping is used and a fully automatic NFPA-99 gas manifold secondary reserve is provided in a temperature compatible location, no additional emergency reserve is required.

- 4. Point of Use Gas Cylinder System Capacity:** Point of use gas cylinder systems shall be located to facilitate direct control by the program for the space being served. Gas volume and storage criteria shall be in accordance NFPA-45, NFPA-55, and the requirements of the Division of the Fire Marshal (DFM).

***Rationale:** These reserves are necessary to ensure supply continuity. Cryogenic sources, even vacuum insulated, are subject to product loss. The requirements ensure that there are at least two sources of supply for all systems, and at least three sources (cryo bulk plus automatic dual bank manifold or automatic dual bank manifold plus independent emergency reserve) for whole building critical systems. The requirements are to ensure reliability and to minimize risks from operational errors or failure conditions.*

**B. Independent Systems:** Laboratory and Animal Research Facility (ARF) gas supply and distribution systems shall be completely independent of gas systems serving human patients and independent for each use type.

**C. Supply Manifold Flow Capacity:** The sizing, selection, and placement of manifolds shall be made in consideration of the worst case ambient conditions in establishing required cylinder volume as associated with vaporization rates and equipment locations. The capacity of in-line gas heaters alone is not adequate, unless vaporization rates of the source and heater size have been addressed.

**D. System Cleanliness:** All gas system components for medical, ARF, or laboratory use shall at a minimum be factory cleaned and packaged for oxygen service, and shall be clean in accordance with ASTM G93 Level C

or Level D, but at least ASTM B819 for copper tube and fittings and CGA G4.1. In no case shall gas systems deliver less than Grade 3.0 purity class services and particles shall in no case exceed ISO 8573-1 2010 Class 3; or requirements for the application, whichever is more stringent.

**E. Standby Power and Critical Systems:** Standby power shall be provided for electrically operated compressed gas equipment, critical gas manifold systems, CO<sub>2</sub>, and monitoring and alarm systems. The extent of criticality of each service shall be reviewed on a per program basis.

***Rationale:** Gas supplies often serve critical equipment and special process needs that must be maintained to prevent loss of research.*

**F. Remote Backup:** Systems shall be arranged such that electrical failures do not interrupt critical supplies, including but not limited to CO<sub>2</sub> and oxygen. Supplementary automatic backup arrangements shall be provided for critical applications where significant damage, injury, or loss of research could result from a central supply failure or error (e.g., compressed nitrogen for NMRs).

**G. Alarm Monitoring:** Automatic monitoring is required for CO<sub>2</sub>, liquid nitrogen, compressed air systems, and any other critical systems identified by the program use group. At minimum, alarms shall be categorized as “General Fault”, “Critical Fault”, and “Supply Emergency” in annunciating to the building automation system (BAS) and also where available to central lab monitoring systems, or for central systems to another approved location that is not specific to an individual program. Additionally, annunciation shall be made on a fault specific basis to a local alarm panel which shall be placed in an area normally occupied such that an alert condition will be immediately detected by responsible personnel. Any fault that is life safety or could result in imminent damage or loss of service or research within 24 hours shall be considered a “Supply Emergency”. Alarm panels shall be closed circuit, self-monitoring to ensure alert in the event of loss of power or other alarm failure.

The status of reserve or secondary supply shall be monitored independently from the status of the primary



supply source. Refer to Tables Table 12.3.1(A) and Table 12.3.1(B) for minimum alarm requirements.

For cryogenic bulk systems with telemetry, the primary source function monitoring shall be accomplished through use of a telemetry system and alarm points as indicated in Table 12.3.1(A), including monitoring from the tank liquid level gauge. For central compressed air systems, BAS monitoring of the compressor system, dryer system, and source line pressure is required.

For all systems, anomalies of supply pressure of 20% or greater above or below the distribution system normal operating pressure shall be monitored and alert to the BAS. The sensor for such monitoring shall be located at the beginning of the supply main, but downstream of final predistribution treatment equipment, main shut-off valves, and pressure regulator stations.

*Rationale: The monitoring of anomalies is to facilitate the tracking of malfunctions and timely response.*

**H. Supply Preservation:** The design shall prevent consumption of each secondary supply during normal use or loss of any secondary supply in the event of malfunction of the primary supply. The design shall also prevent loss of the primary supply due to malfunction of any secondary system. Equipment selections and design shall preserve reserve capacity including due to standby losses and failure conditions (e.g., due to an overpressure relief condition). A check valve shall be provided on the main supply piping from the normal supply source but upstream of the secondary supply, and similarly provided for any reserve to prevent loss of reserves to an upstream

**Table 12.3.1(A) Minimum Alarm Requirements, Typical Bulk Cryogenic Supply With Gas Secondary Reserve**

Alarm Source	Purpose and Label Text at Alarm Panel	Description/ Purpose	Signal to BAS/LAB Monitor	Activation Setpoint
Bulk cryogenic, dry contacts from liquid level gauge	(System) bulk tank supply low	Tank refill required	System general fault	Equipment controller initiated fault, setpoint @ 20% remaining
Bulk cryogenic dry contacts from primary vaporizer controller	(System) vaporizer #1 failure	Vaporizer high temp CO <sub>2</sub> , low temp CO <sub>2</sub> , or other fault	System critical fault	Low temp cut out, high temp cut out and general fault
Bulk cryogenic dry contacts from secondary vaporizer controller	(System) vaporizer #2 failure	Vaporizer high temp CO <sub>2</sub> , low temp CO <sub>2</sub> , or other fault	System critical fault	Low temp cut out, high temp cut out and general fault
Vaporizer #1 and vaporizer #2 control	(System) vaporizers offline	Monitor vaporizer power status	System critical fault	Loss of power as detected by vaporizer control
Secondary reserve manifold	(System) reserve in use	Alert when reserve manifold is supplying system	System supply emergency	Equipment controller or press. Sensor initiated activation point depends on system arrangement
Secondary reserve manifold left and right bank pressure sensors	(System) reserve supply low	Alert the intended reserve capacity not available	System critical fault	~80% normal cylinder pressure at ambient temp detected at either bank (e.g., ~4,140 kPa [600 psig] for CO <sub>2</sub> )
Building supply distribution pressure sensor, leaving mech. room	(System) supply pressure (to LED pressure display module)	Distribution pressure to labs	System supply emergency	~20% above normal distribution pressure ~20% below normal distribution pressure

outlet or supply system breach. Arrangements shall maintain appropriate overpressure protection.

**I. Pressure Relief:** Relief gas from all pressure relief valves and emergency devices shall be piped to the outside. Where approved by code and applicable NFPA standards, inert and non-oxidizing gases may be handled by redundant and compatible exhaust systems to the outside. Wherever reliefs are manifolded or extended such systems shall be arranged and sized to prevent unacceptable back pressure conditions. Unless required by the manufacturer or referenced standards, piping of reliefs to the exterior is not required for the below.

1. Liquid Nitrogen (LN<sub>2</sub>) freezer and dewar vents where the serving bulk system incorporates appropriate overfill and pressure protection along with appropriate O<sub>2</sub> level monitoring at equipment vent locations, including fail-safe overpressure and overfill control.
2. Clean compressed air as well as single or double cylinder non-hazardous equipment that does not require connection to a piped relief system to exterior for compliance with referenced codes, CGA, or manufacturer recommendations. The use of small manifolds may be exempted from exterior venting where the arrangement would

**Table 12.3.1(B) Minimum Alarm Requirements, Typical Supply Manifold with Reserve**

Alarm Source	Text or Labeling at Alarm Panel	Intended Purpose	Signal To BAS/LAB Monitor	Activation Setpoint
Supply manifold controller	(System) supply status normal	General info (optional feature)	N/A	No detected abnormal conditions
Supply manifold controller, active bank pressure sensor	(System) primary supply low	Replace primary bank	Local: per program central: general	15 to 20% remaining in active primary bank alert & switchover at not below 1,380 kPa (200 psig)
Supply manifold controller reserve bank or secondary manifold	(System) reserve in use	Alert when reserve is supplying system	Local: per program central: general	Equipment controller or press. Sensor initiated. Activation point depends on system arrangement
Secondary reserve bank or manifold pressure sensors	(System) reserve supply low	Supply status of high pressure gas reserve	System critical fault	20% remaining. 1,380 kPa (200 psig) to be considered as empty. (Typ. setpoint 2,070-4,140 kPa [300-600 psig]) varies w/gas & location
Emergency reserve manifold (where provided)	(System) emergency reserve in use	Alert when emergency reserve is supplying system	System supply emergency	Equipment controller or press. Sensor initiated. Activation point depends on system arrangement
Emergency reserve low (where provided)	(System) emergency reserve low	Alert the intended reserve capacity not available	System supply critical fault	~80% normal cylinder pressure at ambient temp detected at cylinder bank (e.g., ~4,140 kPa [600 psig] for CO <sub>2</sub> )
Building supply distribution pressure sensor, leaving mech. room	(System) supply pressure (to led pressure display module)	Distribution pressure to labs	System supply emergency	~20% above normal distribution pressure ~20% below normal distribution pressure

be fully permitted by code and NFPA and CGA standards, additionally, provided the manifold vent is located in a sufficiently ventilated area that under worse case discharge conditions would not result in unsafe occupancy hazards.

3. Where piping of reliefs to the exterior is not required, calculations shall be provided to demonstrate safe discharge conditions. The discharge of relief valves serving gas manifolds shall consider the total connected load that could be vented.

**J. Oxygen and Ambient Gas Level Monitoring:** The alert points, type, and location of all monitoring shall be specific to the application and gas to be detected and shall consist of at least an audible and visual local alert and a remote critical alert as approved by the Division of Occupational Health and Safety (DOHS). Provision of at least two sensors is required. Coordinate provision of emergency power. Systems shall be calibrated and verified.

**K. Source Shut-Off Valves:** Source shut-off valves shall be provided to permit emergency isolation of the gas supply main for any oxidizing, flammable, or corrosive gas. Where such gases are supplied from central gas manifolds or bulk gas supplies, and wherever such manifolds are located behind normally locked doors/gas storage room, the source valve shall be located in an accessible, visible, and properly labeled valve cabinet on the main line from the supply source. Where the gas supply is critical, an alarm pressure transducer or tamper switch shall be provided to monitor the system. The location of the isolation valve shall also be coordinated with the fire marshal having jurisdiction (DFM). Actuation of an emergency shut-off shall not require operators to pass through a hazardous or emergency condition.

**L. Distribution of Hazardous Fluids:** Central distribution of toxic, lethal, corrosive, or hazardous fluids, including flammable and explosive gases (excepting natural/fuel gas) is prohibited. Distribution of hazardous fluids shall require a predesign requirements meeting be held with ORF, DOHS, and DFM. Natural gas (or propane where natural gas is not available and is required and approved by DFM) does not require special review.

**M. Codes and Standards:** Conformance with ASME B31.3, B31.9, NFPA-55, and applicable

recommendations of the CGA is required for all compressed gas and cryogenic systems.

**N. Maximum Distribution Pressure:** Gas distribution pressure shall be below 1034 kPa (150 psig). Hazardous fluids distribution pressure shall be minimized.

**O. Pressure Regulators and Overpressure Protection:** There shall be at least two regulators in series (or a suitable two-stage regulator) between high pressure bulk tank or high pressure cylinder sources and the building distribution system wherever failure of a regulator could result in unsafe pressure or damage to infrastructure or scientific equipment. Two-stage or two regulators in series shall also be used for critical pressure control and hazardous applications; except that, pilot/dome loaded or combination dome and spring loaded units may be used as suitable. Relieving type regulators shall be used where required as final regulators to protect sensitive equipment; however, regulators that relieve gas into the facility shall not be used for non-inert, hazardous fluids, or oxidizers or without adequate ventilation. Pressure regulators used for central supply systems shall be pressure loaded diaphragm with pilot, dome loaded, or pilot operated, and shall be process/industrial flow-to-open type. Pilot supplies shall be the process fluid unless justified, using the manufacturers recommended pilot trim, and where used for inert gases a normally closed bleed valve feature shall be provided. All regulators shall be of non-contaminating metal construction with elastomers suitable for the required purity and exposure conditions. Metal diaphragms, internally springless, and electropolished are required for gas grades 4.5 and higher. Droop characteristics, stability, worse case process fluid temperature, pressure differential, Joule-Thompson effects, and consequences of failure modes (including pilot supply) shall be evaluated for all regulator and pilot trim selections. Regulators shall be suitable for at least Grade 3.0 gas purity or system application, whichever is greater. Single stage spring load regulators may be used for gas manifold line regulators where a second or dome loaded unit is upstream or downstream, or for local applications near the point of use suitable to the droop, turn-down ratio, and readjustment requirements.

**P. Flow Meters and Gauges:** Flow meters and gauges shall be calibrated and direct reading type for the specific gas. Pressure gauges shall be liquid filled, non-contaminating, and industrial/process grade.

**Q. Supplementary Overpressure Protection:**

Overpressure relief shall be provided to protect systems and equipment from unacceptable high pressure in accordance with ASME B31.3 and recommendations of the CGA. Overpressure relief shall also be non-contaminating and suitable to protect from the total energy source. Relief valve setting specification shall be coordinated with pressure and configuration of each supply and backup system to prevent premature operation.

**R. Fluid Temperature:** Systems shall be designed to protect from damage, injury, and disruption associated with gas temperature. Joule-Thompson cooling effects shall be addressed in the sizing, selection, and configuration of components. Distribution of gases shall normally be below 35°C (95°F) and temperatures above 49°C (120°F) are not permitted.

**S. Materials Compatibility:** Materials including seal tapes shall be compatible to system application, fluid, and cleanliness. Regulators, filters, and components for O<sub>2</sub>, cryogenic, and hazardous systems shall be specifically designed and constructed for such use. In selecting materials, elastomers, and components, potential of phase change (e.g., CO<sub>2</sub>) and reactions (e.g., carbonic acid, ignition, decompression) shall be considered.

**T. Appurtenance Sizing:** Appurtenances (e.g., regulators, control, check valves etc.) shall be sized on actual flow and velocity coefficients and application.

**U. Equipment Connections/Serrated Outlets/Turrets/Pipe Adapters:** Equipment connections shall be hard piped or connected with appropriate manufactured gas connectors or approved flexible tubing compatible with the application. Flexible connectors shall be accessible. An accessible isolation valve shall be provided upstream of each individual equipment item. Movable equipment shall be provided with a restraint device where flexible connectors or tubing is utilized. The use of serrated tips for connection of hoses to equipment is not acceptable due to potential for blow-out. Serrated connections are only permitted for single-user-control lines that are intermittently pressurized and then only under low pressures. Connections of brazed piping to threaded connections (e.g., connections to turrets or stainless steel) shall be made with either an approved stainless steel axial-swaged elastic strained metal-to-metal seal preload fitting adapter (e.g., Lok-Ring for stainless only), a VCR type compatible and non-contaminating metal gasket seal x threaded adapter, or provided the

connection is accessible, may be an approved double ferrule x threaded connection (e.g., Swagelok adapter). Swagelok type connections shall not be used as a transition for differing pipe materials. The connection shall be clean for oxygen service. Brazed wrought copper adapters are not permitted.

*Rationale: High temperatures associated with brazing will anneal copper fittings and result in poor sealing. Solder joints are not permitted due to contamination potential.*

**V. Grounding Electrode:** Conductive piping systems carrying hazardous or flammable fluids shall be electrically bonded to a grounding electrode in accordance with NFPA-70, NFPA 77, NFPA-55, and NFPA-54.

**W. Testing, Qualification, System Verification, and Cleanliness Procedures:**

1. Prior to operation, gas systems shall be verified free of cross-connections, pressure tested to at least 150% design operating pressure using inert gas of cleanliness and purity not less than the design process fluid, and verified for required cleanliness and purity throughout the entire system. Systems shall be leak tight after the temperature stabilization period for a minimum of 8 hours. Test and purge gas from portable sources shall be Grade 4 or better argon, nitrogen, or equal for the application, filtered with a sub-micron stainless steel filter and verified for proper grade cleanliness (at least particulate) prior to use in systems. Once complete, systems shall be charged with clean, dry filtered nitrogen, argon, or other non-contaminating inert gas. Quantity of outlets to be checked shall be determined by application, but not less than one random outlet per floor near the beginning, middle, and end of system and at connection points for sensitive scientific equipment. QA during and pre-construction shall be provided to avoid test failures.
2. Unless stated otherwise or higher quality is required by referenced standards for inert gases, the maximum allowable contaminants shall be as required for lab air.
3. Sensitive leak tests (inboard/outboard helium) shall be provided in addition to pressure testing

for specialty system applications where required for safety or system purity.

4. For compressed air, nitrogen, oxygen, and other inert gas, verification of pressure dewpoint, total hydrocarbon (including aerosol, vapor and gaseous contaminants), and particulates is required. For CO<sub>2</sub>, particulate and dewpoint shall be verified. All new systems and wherever possible prior to charging system with CO<sub>2</sub>, total hydrocarbons (including vapor and also gaseous contaminants) shall be verified to confirm system cleanliness (utilizing nitrogen or argon as the test gas prior to introducing CO<sub>2</sub>). Ultra-high purity systems shall additionally include oxygen, moisture, purity, testing, and any other tests appropriate to the application, including purity testing of purge gas, at each source and use point. Hazardous fluid systems shall be verified free of reactants. Concentration of methane equivalent to ambient air may be disregarded (up to 2 ppm), unless inapplicable.
5. Testing methods for lab air/compressed air shall be in conformance with the ISO 8573 standards. Sampling and lab analysis (by compressed air testing labs) or on-site calibrated instrumentation using ISO 8573 values is acceptable. For hydrocarbons and gaseous contaminants, alternative methods that demonstrate adequate sensitivity may also be utilized as appropriate (e.g., flame ionization, gas chromatography, etc.).
6. Testing methods as outlined for lab air may be used for carbon dioxide. CO<sub>2</sub> system testing may also be carried out by an ASSE 6030 medical gas verifier following the process as utilized for O<sub>2</sub> or medical air systems for NFPA-99 Category 1 O<sub>2</sub>; or medical air systems with regard to particulates, dewpoint, and hydrocarbon aerosol, vapor, and gaseous contaminants. Tests shall be conducted prior to charging with CO<sub>2</sub> and utilizing clean, dry nitrogen as the system test gas with the dewpoint test conducted as pressure dewpoint at not less than system operating pressure or a pressure of 207 kPa (30 psig), whichever is greater.
7. For non-patient oxygen verify as per NFPA-99 Category 1 with regard to all contaminants. An

ASSE 6030 medical gas verifier may be utilized for the required gas purity, except for ultra-high purity (UHP) applications.

8. For ultra-high purity and hazardous gases, sensitive leak test reports, on-site particle test, moisture, hydrocarbons, and oxygen analysis of system and delivered gas purity are required by a third party, experienced UHP quality assurance firm, following an approved QA plan. SEMI/Sematech methods, e.g., SEMI-F70, SEMI-F112, and ASTM F1398 may be utilized.

***Rationale:** These requirements are to verify the cleanliness of the piping distribution systems and provide indications of the suitability of the completed system to reliably deliver uncontaminated gas. The use of filtered, clean, dry nitrogen or argon as a test gas for CO<sub>2</sub> and other inert systems prior to introduction of the process fluid allows for a cost-effective confirmation of system cleanliness.*

9. When testing piping distribution systems for system construction cleanliness, testing shall be conducted prior to application of any polishing adsorption filters or similar treatment devices that may interfere or conceal the presence of contaminants.

## 12.3.2 Bulk Gas and Cryogenic Systems

**A. Cryogenic Systems Codes and Standards:** Cryogenic systems shall be designed and installed in conformance with NFPA standards, ASME B31.3 Process Piping Code (or alternatively B31.1 as applicable), Code of Federal Regulations (49 CFR), and Section III of the ASME Boiler and Pressure Vessel Code. Microbulk systems shall be subject to the same general requirements as for other bulk cryogenic systems.

**B. Bulk System Location:** Bulk systems shall be located in a secured exterior area, not subject to submergence, and in compliance with NFPA standards and safety recommendations of the bulk supplier. Cryogenic



systems shall be located to minimize cryogenic distribution piping.

**C. Purveyor:** For cases where a set contract is in place, the PO can advise as to the gas purveyor to be utilized for provision and service of the bulk cryogenic tank farm and how systems are to be specified for purchase or rental.

**D. Documentation:** Systems design shall demonstrate adequate sizing, placement of pressure relief arrangements and protection from any condition which could cause plausible single point failure or loss of cryogenic supply. Cryogenic systems shall be inspected by the cryogenic design professional or designated cryogenic inspector to ensure safety and reliability prior to startup.

**E. System Continuity and Redundancy:** Duplex vaporizers, refrigeration units (where applicable), and related near tank equipment with automatic switchover shall be provided to ensure continuity of service and shall be arranged to prevent single point failures or disruptions service. Controls and near tank equipment shall be designed and adjusted to prevent flow of fluids into buildings under the wrong phase (e.g., liquid vs. gas), this includes when equipment is under failure conditions. Vaporizers, heaters, and other equipment required to maintain system flow shall automatically return to operation upon restart of power, except where such restart may pose safety hazards. Reliability configurations shall at least meet requirements for an NFPA-99 Category 1 system, unless otherwise approved.

**F. Emergency Connection:** Bulk systems shall be provided with a connection for emergency backup bulk supply (tanker truck, micro-bulk, etc.). Coordinate with serving cryogenic vendor.

**G. Secondary Supply and Emergency Reserves:** The provisions of secondary supply systems is not required where systems distribute cryogenic fluid only to laboratory equipment which includes an acceptable safe-hold reserve time that would be sufficient to prevent loss of research (e.g., some types of LN<sub>2</sub> freezers). Extent of redundancy shall be reviewed with the program on a project and site-specific basis. Cryogenic source to gas supply systems shall be per [Section 12.3.1 General Design Requirements](#).

***Rationale:** Continuity of supply is critical to avoid loss of research. As bulk cryogenic systems are well monitored, the most plausible cause of supply losses are typically overfill, improper component operation, or failure of a rupture disk or auxiliary component malfunction.*

**H. Telemetry System/Alarm Monitoring:** Bulk cryogenic supply systems shall include a telemetry system that is compatible with the various vendor suppliers as utilized by the facility. A second alert shall be provided to the BAS for any critical supply condition and as indicated in [Table 12.3.1\(A\)](#). Systems that allow off-site equipment control are not permitted.

**I. Materials/Cleanliness/Gas Purity:** Bulk systems supplies and distribution, including the bulk tank, equipment, appurtenances, valves, and piping construction shall be of materials, design, and cleanliness to provide at least *USP-NF*-grade product for any medical application, and at least Grade 4 (99.99%) for any lab application. Beverage grade (99.9%) CO<sub>2</sub>, shall be utilized as a minimum. Cryogenic tanks, including CO<sub>2</sub> shall be vacuum jacketed only.

**J. Pressure Relief, Rapid Product Loss, and Overfill Protection:** Systems shall be provided with appropriate pressure relief and overfill protection designs that relieve overpressure conditions at the bulk tank and prevent risk of venting such conditions through building systems or cryogenic freezer relief valves. Rupture disks are not permitted for CO<sub>2</sub> systems. Systems shall be provided with automatic monitoring and protection to protect from an emergency condition or extensive system “recharge” efforts as could be caused by extreme system fluid loss, e.g., due to fill valve being left open or other operator error. The approach shall be documented and included in the sequence of operations (typically a critical alert, telemetry, and fail-safe valve).

**K. Distribution System Material, Location and Thermal Stress Control:** Cryogenic piping systems shall be vacuum jacketed with static (passive) vacuum jacket systems and shall include an appropriate flexibility analysis. Slope shall be upward in direction of flow. Cryogenic piping systems shall be accessible for service.



**L. Controls:** The application of pressure relief devices, cryovents, phase separators, gas traps, heaters, fill sequencers, and other specialized controls shall be included and accessibly located within each system and documented on drawings. Caps shall be provided on valves to prevent unintentional operation or discharge due to leak or accidental displacement. Lock-outs shall be provided as required to preserve product and safety functions.

**M. Pressure Relief:** Pressure relief shall be provided for any potential trapped sections in cryogenic systems, e.g., where sequential valves occur. Vent lines shall be protected from ice blockage. Cryovents shall be vacuum insulated. Vents from pressure relief shall not be arranged in any manner which could result in unacceptable backpressure or blockage.

**N. Future Expansion Provisions:** Bayonet cap connections shall be provided at points where future expansion is anticipated.

**O. Flexible Equipment Connections:** Flex lines shall be vacuum insulated and flexible type where necessary to maintain efficiency, protect from condensation, and be provided with an appropriate restraint or chain to prevent breakage.

**P. Dewar Fill Stations:** Dewar fill station locations are typically located outside the building (often near the loading dock) at a location that allows safe transport of dewars to/from use points. Nitrogen dewar fill stations shall be of the fully automatic and secured type. Where any dewar fill station is indoors, locations shall be coordinated with HVAC systems for proper ventilation.

**Q. Gas Monitors/Alarms:** Oxygen level monitors (and/or other gas specific leak detectors) and visible/audible alarms shall be provided as appropriate to the cryogenic service. Alarms shall be connected to building emergency power.

**R. Automatic Supply Shut-off:** Confirmed low oxygen condition (not initial alert) in primary cryogenic fluid usage areas (e.g., freezer farms) shall provide automatic shut-off of the cryogenic supply and critical remote alarm notification (BAS and the lab monitoring system). The automatic shut-off shall not disrupt gaseous supply to other areas of the facility.

**S. Auxiliary Equipment:** The type of vaporizers, valves, and components shall be selected to be suitable for year-round climate conditions. Vaporizers shall include a high temperature and low temperature cut-off with alarm to BAS. A low-pressure cut-off is additionally required unless the vaporizer is a pressure-building type. The arrangement shall protect from cryogen entering the piping in event of power failure or heater failure. Vaporizers shall include auto-restart upon power restoration and a general fault alarm to BAS. Normal distribution temperature from CO<sub>2</sub> vaporizers and trim heaters should typically be between 24°C–38°C (75°–100°F).

**T. Gas Handling, Near Bulk Tank Equipment:** Gas lines in climates where the worst case exposure could reach the saturation temperature of the gas shall be protected (including CO<sub>2</sub> systems in Bethesda). After the vaporizer, exposed exterior pipe lines for such gases (including CO<sub>2</sub>) shall be minimized and where present shall be insulated. Exterior pressure regulators shall be provided with a removable insulation jacket. Exterior gas pressure regulators (where provided) for CO<sub>2</sub> located outside the building shall not turn down pressure to below 450 kPa (65 psig). Gas and cryogen pressure shall be maintained below approved ratings.

**U. Emergency Connection:** An emergency auxiliary connection shall be provided for supply mains from bulk systems wherever the bulk system is remote from the facility location, wherever supply piping is buried underground (other than in accessible tunnels) or to provide a means of supply from a tanker truck in an emergency. Such connection shall be configured similar to an emergency oxygen connection as required for medical gas systems. An emergency connection is not a substitute for the required emergency reserve for gas systems.

*Rationale: The basic standards for bulk tank and cryogenic systems ensure the design provides for reliable, safe and efficient operation and protection from disruptions and equipment damage.*

### 12.3.3 Compressed Gas System Sizing, Components, and General Distribution Requirements

**A. Distribution Routing:** Refer to [Section 8.1 Plumbing General Requirements](#).

**B. Underground Piping:** Piping shall be routed above ground in accessible locations. Underground lines may occasionally be required and acceptable on a project-specific basis when sleeved and provided with metallic warning tape and concrete barrier. Direct-buried underground piping is not acceptable for toxic, corrosive, or hazardous services.

**C. Velocity and Pressure Drop:** In general and unless noted otherwise, maximum velocity in distribution systems shall not exceed 20 m/s (4,000 fpm), 6 m/s (1,200 fpm) for central plant equipment; and pressure drop shall not exceed 10% for systems operating above 380 kPa (55 psi), and shall not exceed 20 kPa (3 psi) for systems operating at or below 380 kPa (55 psi).

**D. Biological Safety Cabinets:** Pressurized, flammable, and hazardous gases shall not be piped into a biological safety cabinet (BSC) unless approved by the DOHS.

***Rationale:** The use of compressed gases (e.g., lab air and fuel gas) has been shown to disturb airflow patterns within BSCs and create hazardous conditions.*

**E. System Integrity, Quality, and Cleanliness:** Pressurized gases including all general lab gases, CO<sub>2</sub>, compressed air, and other gases (but with the exception of fuel gas, and instrument air) shall utilize materials, handling, installation, and test procedures to maintain system cleanliness, and deliver gas at least equivalent to Grade 3.0 (99.9% purity) or Grade 4.0 (99.99% purity) gases, and shall be designed and installed in conformance with the CGA guidelines.

1. Brazing criteria of general lab gases shall meet Section IX, ASME Boiler and Pressure Vessel Code or ANSI/AWS B2.2 Standard for Brazing Procedure & Performance Qualifications, both as modified by NFPA-99 or the Copper Development Association for medical gas

application. A purge gas flow meter and O<sub>2</sub> analyzer is required for all brazing.

2. Orbital welding is required where welded systems are utilized for any clean or high purity fluid or critical process fluid application.
3. Where gas distribution systems are stainless steel, conform to at least ASTM G93 Level C or Level D requirements except where higher purity standards are required.
4. Valves and all other fluid contact components shall be clean for oxygen service, at least to the required standards of the system.
5. Pipe and fittings serving high pressure gas (greater than 3,450 kPa [500 psig]) or cryogen shall be forged (not cast). Threaded wrought copper adapters shall be brazed only with approved alloy (BCuP-9 or BAg-5) to prevent annealing. Connections to turrets shall be made with swagelock adapters, lok-ring adapters for stainless steel tubing only, or brazed male adapter and a threaded brass coupling.

***Rationale:** Materials and joining operations can introduce substantial contaminants into compressed gas distribution systems. A variety of scientific equipment and research applications are dependent upon service from clean, dry, uncontaminated gas streams. Intent is to maintain specified gas quality and minimize point of use filters.*

**F. Pipe/Valve/Termination Labeling:** Services shall be labeled in accordance with [Chapter 8: Plumbing Design](#). Where a gas service is supplied at multiple pressures or differing gas qualities, each respective gas system shall be clearly labeled. Service outlets and terminations shall be clearly identified.

**G. Local Reserves:** Critical applications (e.g., NMR's) require reserve supply arrangements as a backup to central systems. Where an individual lab or program areas is provided with a backup gas supply, a gas-tight check valve shall be provided on the main pipeline serving the lab, downstream of the lab shut-off.

**H. Point of Use Treatment:** Point of use gas conditioning devices shall be provided for individual critical

applications beyond the standard central-system-delivered gas quality as required by the program. Filters and traps shall be rated for the specific delivered gas-quality application. Where point of use dryers are required, heatless regenerative or membrane type units shall be applied, and membrane dryers are required for dew-points below  $-73^{\circ}\text{C}$  ( $-100^{\circ}\text{F}$ ). Systems shall not be piped building wide at purity levels higher than those mandated in the DRM for central systems unless required by the program.

***Rationale:** Point of use filter/dryer/treatment systems are often required for specialty equipment e.g., NMR's, LC/MS, pure gas generators. Avoidance of widespread use must be considered in the central air quality selection. Over-design of central system quality can be uneconomical and subject to contamination.*

## 12.3.4 Compressed Air Systems, Additional Requirements

**A. Compressed Air Critical Service:** Central compressed air is considered a critical service and shall be arranged to ensure continuous availability of required quality.

**B. Compressed Air Production:** Cylinder manifolds of a suitable air grade or dry nitrogen may be utilized for very limited applications where provision of central compressed air equipment would be impractical or unjustified based on a very limited demand usage and shall be approved by the program user group and PO.

### 12.3.4.1 Compressed Air Quality

Compressed air shall be produced and distributed to meet the following baseline criteria:

**A. Minimum Requirement:** Where higher quality air than the baseline DRM requirements are necessary but not predominantly required, additional conditioning shall be provided at the necessary points-of-use rather than centrally.

Minimum Baseline requirements are as follows:

- 1. Particles:** Comply with ISO 8573.1 and ISO 8573.4, 2010 Class 2 for particles. There is no criteria for particles 0.5 micron and smaller, and count values of up to 500 are acceptable for 1 to 5 micron size class.
- 2. Pressure Dewpoint and Liquid Contaminants:** Maximum pressure dewpoint shall not exceed  $-12^{\circ}\text{C}$  ( $10^{\circ}\text{F}$ ) through dryers capable of producing air at system design capacity down to  $-40^{\circ}\text{C}$  ( $-40^{\circ}\text{F}$ ). In no case shall the provided dewpoint be higher than  $10^{\circ}\text{C}$  ( $18^{\circ}\text{F}$ ) below the lowest temperature at which any portion of the system distribution will be exposed at any time of year. In many cases sufficient predominant needs may support that air be dried to  $-20^{\circ}\text{C}$  ( $-4^{\circ}\text{F}$ ) (ISO 8573.1 2010 Class 3 for dewpoint) and distributed at that level.  $-40^{\circ}\text{C}$  ( $-40^{\circ}\text{F}$ ) and lower building-wide distribution is not typically required or desirable on a building-wide basis for lab air; however, capability to distribute at this dewpoint shall be provided. Systems shall be designed and equipment selected to be free of liquid contaminants, including air intake and compressor fluids.
- 3. Hydrocarbons:** There shall be no detectable liquid hydrocarbon, and total including vapor not to exceed 0.08 ppm maximum (ISO 8573.1 2010 Class 2 for hydrocarbon).
- 4. Gaseous Contaminants:** Gaseous contaminants introduction shall be controlled by air intake placement, equipment type and materials of construction. Where specific contaminants are of concern to the program or unique equipment needs, additional measures of air treatment and verification shall be required and shall be provided with N + 1 redundancy (in parallel).

***Rationale:** Maximum values are to provide suitable air quality that is most flexible for varied uses with minimal required maintenance, and a balance of initial and on-going operating cost, distribution system cleanliness, and minimal need for point-of-use treatment. Pressure dewpoint control is critical to maintaining air quality, microbial growth, particle, and water accumulation. Many*

*instruments have high sensitivities to hydrocarbons and other contaminants.*

#### 12.3.4.2 Compressed Air System Source Arrangement

**A. NIH Bethesda Campus:** Air for building processes is produced at the central utility plant and distributed to each building. This air is delivered to buildings at a pressure range of 690–830 kPa (100–120 psi) and is distributed throughout each facility at the delivered central plant air pressure, considered nominal 760 kPa (110 psi).

**B. Primary Pressure Control:** For any case where air may be delivered to a building at pressure above 860 kPa (125 psi), a non-contaminating main-line pressure control station shall be provided at the service entrance.

**C. Compressed Air Production:** Within each building, a dedicated compressed air production system shall be installed as a backup to the central system and shall be capable of supplying 100% of the system peak demand with the plant air system completely out of service. Air from the campus central plant shall intertie into the building system as indicated in this section. A controls arrangement with a pressure transmitter and normally closed automatic control valve shall automatically activate the backup system upon pressure loss or drop below 690 kPa (100 psi) and restore plant supply once incoming line pressure is restored. The system's operating status shall tie in to the BAS.

**D. Required Compressor Quantity, Arrangement, and Capacity Split:** Air compressors shall be provided for each building to serve as the primary air supply (for cases where there is no central plant supply) and as a backup supply for cases where an adequate central plant supply is available. A minimum of two compressor systems shall be used to provide N + 1 redundancy (100/100%); however, for large systems it is recommended that at least triplex (50/50/50%) compressor arrangements be used for optimal efficiency.

#### 12.3.4.3 Compressed Air Equipment

**A. Air Compressor Type:** Air compressors shall be oil-free type. Rotary screw configuration shall be used for central systems except that oil-free scroll-type

compressors may be used for small systems, point of use, and where required for local backup applications. Equipment shall be sized to provide 860 to 1034 kPa (125 to 150 psi) at the compressor outlet for lab applications, and may be of other pressures for other applications as required. VFD trim compressors may be used. Stable pressure shall be maintained and integrated with the control sequence through a pressure loaded diaphragm/pilot operated pressure-reducing station or electronic flow control station.

**B. Compressor Cooling and Heat Loads:** Liquid-cooled air compressors shall be used for large systems where cooling water is available.

**C. Automatic Exerciser:** All compressors shall include an automatic exerciser such that each compressor is activated for sufficient run time at least once per week.

**D. Control Systems and BAS Interface:** Local control systems with system operating status and local alarm condition readout shall be provided at the equipment. A remote signal to the BAS shall be provided for general fault alarm for each system source (addressing system pressure, operating status, and major air quality condition, e.g., a dryer failure or dewpoint alarm) unless more stringent monitoring is required for the application. A critical fault alarm shall be provided for total air supply failure. The operating status (local compressor or central plant supply active) shall report through BAS.

**E. Continuity and Redundancy:** Compressors and associated air supply equipment and controls shall be arranged to prevent plausible single point failure and to permit independent shutdown and maintenance repair while maintaining the redundant compressor system in operation to prevent disruption of air supply.

**F. After-coolers and Wet Receiver:** A primary wet receiver with valved bypass shall be provided downstream of the compressor after-coolers and any required water separator, but prior to primary air treatment, and shall be of stainless steel construction. Tanks shall be ASME code with piping arrangements and ports to facilitate moisture fallout as air cools. Interior baffles (where provided) shall be stainless steel. After-coolers shall be in parallel, and include independent traps and automatic drains. After-coolers shall not be a substitute for dryers or wet receivers.



**Rationale:** *A wet receiver provides preliminary moisture removal, additional cooling, and helps to minimize short cycling of compressors and reduce load on dryers and filters. This can reduce operating costs associated with producing compressed air.*

**G. Dryers:** Dryers shall be regenerative (desiccant) type and shall be pressure swing (heatless regeneration), heat of compression, or be externally heated. Internal bed heaters are not permitted. Central system dryers shall be arranged for N + 1 redundancy. Dewpoint demand controls (to lower purge air) and moisture indicators shall be provided. Dryer sizing shall be based on output air of -40°C (-40°F) pressure dewpoint (even though operation point may be higher). Applications requiring a lower-pressure dewpoint shall be handled local to the application though they shall be supplied with air dried to the common design distribution of the facility. Heat of compression dryers shall only be used with oil-free compressors. Dryer settings and purge rates shall be specified to be factory-optimized for operation at the specified pressure-dewpoint setting. Deliquescent dryers are not acceptable.

**Rationale:** *Internally heated bed dryers are avoided due to potential fire hazards and potential air quality issues. Deliquescent dryers can impose unacceptable maintenance and chemical discharge.*

**H. Dewpoint Monitor:** A dewpoint monitor shall be provided, after the dryers but prior to the pressure regulator station, with alarm to the BAS.

**I. Membrane Dryers:** Membrane dryers may be utilized for specific applications (e.g., point of use). Membrane dryers shall include appropriate automatic-sweep gas-saver controls and porting. Where membrane dryers are provided at points-of-use downstream of a system utilizing desiccant dryers, additional point of use filtration shall be provided to protect the membrane. Membrane dryers shall include adjustable pressure dewpoint control and a sweep gas curve shall be provided for equipment adjustment. Where membrane dryers are approved for use as primary system dryers, automatic alternation arrangements shall be provided and the arrangement shall be designed to minimize sweep air loss and maintain

dryer in a ready-conditioned state for immediate moisture removal. Membrane dryers shall be provided with protection from pressure surges.

**J. Dry Receivers:** Dry receivers (ballast air tanks) shall be provided and shall be ASME code, stainless steel, suitable to required air quality, sized to stabilize compressor operation and pressure surges. A valved bypass shall be provided. For control air, and other applications that are not pharmaceutical, medical, veterinary, lab air, or of high cleanliness requirement, the use of epoxy coated receivers is acceptable downstream of desiccant dryers.

**K. Filters:** Filter arrangements shall be redundant N + 1 (in parallel) to provided specified air quality continuously. At a minimum, a coalescing prefilter shall be provided ahead of desiccant dryers and particulate filters shall be provided immediately after the desiccant dryers, followed by final high efficiency system filters as required after the dry air receiver. All filters shall be compliant and certified with latest ISO 8573 and ISO 12500 standards applied respectively to the filter application (for lab air, ISO 8573 2010 Class 2 for the final filter). Filter capacity shall not necessitate element changing at intervals more frequent than 6 months.

**L. Plant Air Intertie Conditioning:** Where the system includes connection with central plant air, the incoming plant air supply shall be provided with an ISO 8573.9 and ISO 12500-4 compliant dedicated water separator and shall then connect through the wet receiver, followed by N + 1 coalescing prefilter and high-efficiency coalescing/particulate filters upstream of the air dryer connections.

**Rationale:** *Lab air systems are intended to provide high-quality air; however, incoming plant air may be contaminated by the time it reaches individual buildings.*

**M. Sizing/Maximum Pressure Drop:** Maximum pressure drop through loaded filters and equipment shall be considered to ensure required air pressure, including after accounting for any pressure-reducing valve losses, beds, and sequencing scenarios provides for at least 760 kPa (110 psi) air to the building and 690 kPa (100 psi) at high-pressure remote use points. Filters shall not exceed 3 psi loaded loss at full-demand airflow. For applications of low pressure systems, the maximum pressure loss through the entire distribution system at peak

demand shall not exceed approximately 20 kPa (3 psi), except total loss of up to 10% is acceptable for systems operating above 380 kPa (55 psig).

**N. Drains:** Automatic drains with air-loss control (e.g., zero-loss drains) shall be provided for central system tanks, filters, and other applications where drainage is required.

#### 12.3.4.4 Central Lab Air System, Additional Requirements

**A. Standby:** Standby power and auto restart is required where systems provide air as a primary supply, backup for control or instrument air functions, for research needs that could be lost, damaged, or compromised due to air supply loss (e.g., NMR equipment and various analytical applications).

**B. Air Intakes and Ventilation:** Air intakes for central compressed air systems (other than dedicated control air) shall be taken from the exterior of the facility, above the roof, or at least 6.0 m (20 ft.) above grade, away from loading docks, generator exhaust or other potential sources of air contamination and hydrocarbons, at least 7.6 m (25 ft.) from any powered exhaust or likely source of contamination, above any potential snow line or source of liquid infiltration, piped directly to air compressors, and equipped with N + 1 air intake filtration.

Air intakes shall be non-corrosive, metallic construction, equivalent to the piping distribution material, and joined without flux or volatile contaminants. Sizing of compressed air intake shall allow for at least the full load with 20% overage, without exceeding maximum recommended velocities. Refer to [Section 6.1 Heating, Ventilation, and Air Conditioning Design](#) for maximum duct velocities, which shall also be complied with for air intakes. Ducted air intake is not required for dedicated control air or local non-critical air compressor systems where such compressors are located in clean areas; where air intake quality will not be subject to compromise and system delivery is reliably within specified air quality requirements for the application.

***Rationale:** Contaminants in intake air can become highly concentrated and condense as free air is compressed.*

**C. Pressure Regulator Stations and Subsystems:** Central pressure regulator stations shall be provided for each air distribution system. Except for low pressure lab air, the reduction and segregation to separate systems shall occur at the primary equipment location. Regulators for central lab compressor-generated air systems may be single stage. Main system regulators shall be pressure loaded central system type per [Section 12.3.1 General Design Requirements](#), except that electronic flow control stations with a normally closed bypass and with either redundant configuration or with a central system pressure loaded regulator for a bypass may be used for the supply main from the compressors at the mechanical room. The following systems and distribution pressure arrangements shall be provided:

1. 760 kPa (110 psi) general high-pressure lab air distribution. Distribute from the mechanical room/air source throughout the building.
2. Pressure-reduction for low-pressure lab air to 207 to 241 kPa (30 to 35 psig) shall occur at each individual floor level (within interstitial space where provided or other accessible common area) from main high-pressure risers.

#### 12.3.4.5 Control Air/Instrument Air Systems, Additional Requirements

**A. Segregation:** Control air systems shall be centrally segregated from central lab air systems, with dedicated distribution networks that are not serving with other functions.

**B. Continuity and Redundancy:** At a minimum, N + 1 redundancy of supply is required. To achieve redundancy, the control air system may be connected to the central building lab air system at the lab air compressor mechanical room to serve as the primary or backup arrangement or control air systems may be provided as dedicated and fully redundant independent systems. Either rotary screw or reciprocating equipment may be used and shall be arranged to prevent flow reversal.

1. Separate locations of source equipment between the primary and redundant configuration is recommended to prevent simultaneous failure.
2. Control air systems shall be arranged to prevent plausible loss of air supply, from single point failure of air production equipment. The use of a



receiver is not a substitute for redundant supply equipment and associated air treatment.

3. Standby Power: Primary and redundant systems shall each be provided with standby power.

*Rationale: Control air must be constantly available to serve critical applications within the facility.*

**C. Control Air Quality:** Control air quality shall meet ISO 8573.1 2010 Class 3 for particles, Class 3 for pressure dewpoint (except where Class 4 is determined suitable), and Class 2 for hydrocarbon or not to exceed 0.5 mg/m<sup>3</sup> (0.4 ppm) of aerosol and vapor hydrocarbons. Where particles are measured by mass, do not exceed 0.5 mg/m<sup>3</sup>. ANSI ISA S7.0.01 Quality Standard for Instrument Air may be used for dedicated control air systems serving non-critical applications.

**D. Dewpoint Requirements:** Where control air dewpoint requirements must be lower than utilized for the building lab air system and systems are interconnected, dedicated dryers shall be provided to further reduce dewpoint of any interconnecting airline serving the control air system.

**E. Door Operators:** Process air, serving door operators and similar devices shall meet the ANSI ISA S7.0.01 Quality Standard for Instrument Air. They are not required to be clean for oxygen service.

**F. Appurtenance Redundancy:** All dryers, filters, regulators, and appurtenances shall be arranged to provide N + 1 redundancy to allow continuous operation during maintenance and service. Redundant receivers are not required where a bypass is provided.

#### 12.3.4.6 Pharmaceutical Air/Cleanroom Air, Additional Requirements

**A. General:** Pharmaceutical / Cleanroom compressed air/gas shall be fully independent and shall be designed, constructed, and validated as UHP type. Refer to Chapter 13.

#### 12.3.4.7 Compressed Air Distribution

**A. Risers:** Risers for central lab compressed air systems shall be provided as high pressure (nominal 760 kPa [110 psi] pressure systems), so that laboratories may utilize either high-pressure or low-pressure distribution via local pressure-reducing valves at the riser take-offs for each floor to deliver the necessary local or zone low-pressure condition.

High pressure lab air shall be available to each floor at a point no farther than at the connection with risers. High pressure air shall be provided valved and capped (not less than 15 mm size) to each laboratory at the corridor or interstitial space above each lab. Even where high-pressure air is not initially required, valved and capped provisions shall be provided at the distribution space or riser take off for each floor, with forethought in system sizing to permit future connections.

*Rationale: On individual floors, low pressure lab air (207 to 241 kPa [30 to 35 psi]) is utilized for turrets. Combined high-pressure distribution with separate pressure-reducing valve's to each lab is avoided due to maintenance and lack of pressure monitoring associated with numerous pressure-reducing valves, potential regulator failures and unauthorized adjustment.*

**B. Sizing and Maximum Pressure Drop:** High pressure distribution piping systems shall be sized to limit pressure drop to 10% of the system operating pressure. Downstream of the pressure-reducing valves, 240 kPa (35 psi) laboratory air is distributed to turrets and is sized to limit pressure drop to 21 kPa (3 psi) as design demands to the farthest outlet.

**C. Maximum Velocity:** Velocities shall not exceed 1,220 m/min (4,000 ft./min).

**D. Flow Rate:** Conventional lab turrets shall provide a flow of 0.5 L/s (1 cfm) at every outlet station. High pressure air systems are sized based on projected demand requirements and detailed programming (including throughput calculations where diversity is applied). Diversity shall be provided for calculating load to gas turrets.

***Rationale:** To ensure appropriate sizing of distribution systems and ensure adequate supply for program flexibility. Sterilizers, research equipment, and high demand items (e.g., gas generators) may often be in simultaneous use so application of diversity shall be evaluated in consideration of quantity, duration, flow, and throughput requirements.*

### 12.3.5 Supply Manifold Systems

**A. Gas Types and Supply Source:** Commonly used gases required at multiple areas throughout the facility (e.g., CO<sub>2</sub>, nitrogen or other gases) shall be provided via centralized systems. Gases not typically required building wide may be provided local to program area or as a lab specific or point of use gas in cases of very limited or remote usage. In-building piped central gas system cylinders (including cylinders serving local program areas) shall be high pressure gas type (not cryogenic).

**B. Hazardous Gases:** Gas cabinets may be required. Completed systems shall be subjected to a sensitive leak test (typically helium) in addition to conventional high-pressure testing, verification of safe routing, arrangement, and presence of all required safety and control components, including those required to prevent runaway reactions, loss of control, or fluid escape. System leakage rates shall be defined in project specifications.

**C. Cylinder Restraints:** Cylinder restraints shall be provided for all gas cylinders, including for points-of-use in the laboratories. Cylinder restraints shall be secured to the building structure.

**D. Gas Manifolds:** Gas manifold systems (with the exception of single- or double-cylinder point of use gas cylinders where redundancy and automation is not required) shall be automatic or semiautomatic switch-over manifolds as appropriate for the specific gas service.

For critical services, including systems serving incubators, animals, sensitive equipment and to major program areas; fully automatic NFPA-99 type manifolds with dome loaded regulators, dual line regulators and redundancy of components arranged to prevent loss of the

offline bank during normal, standby, and malfunction conditions shall be used and the pressure of each cylinder bank shall be automatically monitored upstream of the primary regulators. Manifold and component selections (e.g., gas heaters) shall be in conformance with manufacturer recommendations for the application, ambient conditions, and flow rates. Submicron particle filters of stainless construction (except oxygen) are required for all manifolds serving Grade 4.0 and higher purity gases. Regulators for grade 4.5 and above shall be barstock stainless steel construction. Pressure regulators for manifolds shall comply with [Section 12.3.1](#). Relief valve settings shall be specified for the application pressure, primary and backup source configurations as required to prevent premature operation. Manifolds shall include a compatible sintered metal filter upstream of the regulator (in parallel or one for each bank) to protect regulators and distribution systems from particles. Stainless sintered metal shall not be used for oxygen.

**E. Liquid Manifolds:** Where quantity of gas required is impractical for high pressure gas cylinders (typically over 30 cylinders) but too small for bulk cryogenic systems; microbulk systems shall be utilized. Use of liquid manifolds requires justification and project-specific approval. Where permitted shall meet requirements of NFPA-99 as would be applicable to a Category 1 application, modified to provide the supply capacity requirements per this section. Flow rate capability (or need for vaporizers shall be verified) and an economizer circuit is required. Cryogenic cylinders, including microbulks are not acceptable for reserve applications. Where a primary supply is from a liquid manifold, an independent emergency high pressure gas reserve is required in addition to the secondary high pressure gas reserve.

**F. Source Pressure, Valves, and Manifold Connectors:** A pressure indicator and isolation valve is required at each source supply for line pressure and to monitor the status of each cylinder bank. Manifold connectors, except O<sub>2</sub>, shall be stainless with checks, CGA keyed.

**G. Monitoring and BAS:** Alarms shall be provided to the responsible program area or other designated monitoring point. For local cylinder systems, the alarm may originate from manifold systems (e.g., NFPA-99 type manifolds) or as separate sensor points in addition to the manifold monitoring. Source pressure monitoring shall also be provided and activate upon a 20% increase or decrease from normal system operating pressure.

**H. Gas Supply Preservation:** Arrangements shall protect against a failure condition resulting in venting of the non-failed component, backup, alternate supply source, or alternate manifold header, and to prevent the loss of reserve supply during normal operation. Check valves are required at appropriate points along with sequenced pressure control, as well as checks at every cylinder connection. In cases where the reserve supply is serving as a remote backup to a bulk gas supply, an appropriate control valve (check valve) shall be provided on the supply main to prevent loss of the reserve gas supply in the event of a bulk system supply pipe break or failure, along with the control valve arrangement to sequence the reserve supply.

**I. Manifold Location:** Manifold locations shall be coordinated in consideration of the effect of ambient condition on gas flow rate, pressure, NEMA rating, and reliability. Worst case temperature conditions shall be considered in establishing required cylinder quantity or provision of heated enclosures. Cylinders shall not be located in direct sunlight or without protection from environmental extremes. High pressure gas cylinders for CO<sub>2</sub> shall not be located where temperatures may exceed 48°C (120°F) or fall below -6.6°C (20°F) at any time. A limit of 48°C (120°F) and -29°C (-20°F) are the limits for other gases unless more stringent are required for the specific application or by a referenced standard. Gas supplies shall be located in an area under control of persons responsible or directly affected by the gas service. Local manifolds shall be located outside of individual laboratories unless serving only a single laboratory occupied by the same user. Manifolds located within a laboratory shall not serve other areas. Gas cylinders shall not be located in sensitive spaces, areas of biosecurity concern, or areas where subject to potential tampering. Where possible, gas supplies shall be located outside of program areas. Locations shall be accessible for materials handling without inducing abnormal hazards.

**J. Gas Appurtenances:** Flash arrestors are required for oxygen and flammable gases. Additional requirements, e.g., flow limiting valves may be required for hazardous gases. Provide additional components per gas purveyor and CGA recommendations for the application.

**K. Auto-Ignition Resistance and Component Compatibility:** Gas manifolds and components shall be designed and listed for auto-ignition resistance when used in oxygen or flammable gas systems.

## 12.3.6 CO<sub>2</sub> Lab Gas, Additional Requirements

**A. Provision of CO<sub>2</sub>:** Provision of central distribution of CO<sub>2</sub> is typically required. CO<sub>2</sub> is a critical service and as such must be arranged to ensure delivered gas quality and reliability.

**B. Capacity:** The A/E shall consult with the program to determine demand loading, quantity, chamber volume, and door opening allowance for incubators. Provide for program requirements, but in no case less than an allowance of three to four door openings per incubator per day and to ensure flexibility for midsize to large chamber volumes. The required gas concentration for sizing CO<sub>2</sub> supplies serving incubators shall be as acceptable to the program, but not less than required to provide a 10% concentration of the chamber volume per incubator per door opening.

**C. Supply Systems:** CO<sub>2</sub> supply systems shall have redundant components to permit continuous operation and high-pressure gas reserve backup to ensure uninterrupted supply to incubators and equipment. Common maintenance items, e.g., vaporizers, refrigeration etc. shall be redundant; however, redundancy of large bulk tanks is not required. Provide gas heaters to ensure proper gas flow. Gas heaters are required if flow will exceed 35 SCFH. Worst case environmental conditions shall be considered for CO<sub>2</sub> manifolds to ensure an adequate gas supply with consideration of both cylinder quantity and regulator flow rates to achieve the required gas flow without disruption.

*Rationale: Gas heaters are typically required to prevent freezing/blockage of regulators, but do not take the place of heated enclosures or indoor placement.*

**D. Oxygen Sensor:** Manifold cylinder systems rooms located within the building shall include oxygen level monitoring alarms or gas leak detection systems as approved by DOHS. Alarms shall alert locally and provide a critical remote alert as approved by DOHS.

**E. Main Line Treatment and Filtration:** A carbon dioxide adsorption filter/treatment system (in parallel) shall be provided for the incoming main carbon dioxide line. The filter shall be located downstream of any supply source

and associated vaporizers but upstream of the required main line pressure sensor and any use points. Each bank of the filter arrangement shall consist of an encapsulated packed activated carbon (adsorption) filter designed to remove hydrocarbon vapors and gaseous contaminants with encapsulation to prevent carbon fines, followed by a 0.01–0.5 micron PTFE or sintered stainless particulate filter; stainless steel housing, pressure gauges and valving to permit isolation of each filter bank for service. The filters shall be non-contaminating for breathing air, food/beverage, or pharmaceutical grade supply applications. The use of manufactured multi-stage CO<sub>2</sub> polishing systems designed for beverage grade CO<sub>2</sub> applications is preferred for central (large) applications. The use of a coalescing filter with any drain arrangement is unacceptable. N + 1 or a suitable filtered bypass shall be provided.

***Rationale:** CO<sub>2</sub> systems, especially bulk tanks, are frequently a source of contamination, including but not limited to condensed oil and gaseous vapors (e.g., volatile and aromatic hydrocarbons). The requirements for central gas filtration provide protection for distribution systems from particles and hydrocarbon aerosols often present in bulk and gas cylinder source supplies.*

**F. Distribution Pressure and Pressure Control:** Central CO<sub>2</sub> system distribution pressure shall be at approximately 207 kPa (30 psi) through use of an initial regulator station at the bulk supply and in-building central regulator station, or through a manifold system per [Section 12.3.5](#). The use of regulator staging (e.g., maintaining exterior pressure above 414 kPa [60 psig]), typically at 448–689 kPa (65–100 psig) and reducing to 207 kPa (30 psig) on the main line inside the facility after gas treatment but prior to distribution is required. Main line regulators shall be pressure-loaded diaphragm type central regulators as indicated in [Section 12.3.1](#) and shall be provided as two in parallel. Where a regulator station is provided upstream of the main line regulators (typically outside the building as part of a cryogenic bulk supply system) a normally closed bypass shall be provided at the exterior primary regulator station. Higher pressure interior distribution, at up to 379 kPa (55 psi) may be used for special applications.

Two-stage heated regulators are permitted. For facilities with limited CO<sub>2</sub> requirements, the system may be fed from manifolded cylinders located in a secure area. The maximum pressure drop at peak demand in the distribution system shall not exceed 21 kPa (3 psi).

***Rationale:** These provisions are for reliable and stable pressure control and to minimize potential for regulator or orifice blockage/freeze-up.*

**G. Fluid Quality and Materials of Construction:** CO<sub>2</sub> shall be at least Grade 3.0 (99.9%)/Beverage grade, except where higher purity is required by the program. CO<sub>2</sub> systems shall be of materials and construction clean to ASTM G93 Level D or better.

***Rationale:** High levels of contaminants are common in uncertified and industrial grade supplies. Control of contaminants is required to preclude inducing variables, meet special application needs and varying equipment requirements.*

**H. Incubator Provisions:** Pressure regulators at incubators shall be selected for sensitive pressure control per equipment manufacturer requirements. A point of use 0.2 micron (minimum) filter shall be provided at incubator connections for particulate protection (typically furnished with incubators), and shall be coordinated with the manufacturer.

**I. Gas Guard Auxiliary Supplies:** Where a lab requests supplemental installation of a backup supply arrangement (e.g., some types of gas guards), a check valve shall be installed at the connection point to prevent back-feeding the central system.

**J. Gas Purity Testing of CO<sub>2</sub> Systems:** The system piping cleanliness testing/verification required of this section shall be provided prior to the adsorption filter installation.



### 12.3.7 Liquid and Gaseous Lab Nitrogen/Argon, Additional Requirements

Nitrogen or argon may be required in some lab facilities as a central system and shall be verified with users on a per project basis. Where large demands are required, a bulk liquid nitrogen storage tank, vaporizers, and associated controls shall be located outside the building.

For facilities with limited gaseous nitrogen requirements, demands may be supplied from manifolded cylinders located in a central area or building cylinder closets. Systems shall be designed to provide an uninterrupted gas supply. Medical gaseous nitrogen distribution systems shall be separate and independent of laboratory distribution systems.

Tank holding rooms, freezer farms, and dewar fill station areas (if indoors) shall include oxygen level monitoring alarms. Alarms shall alert locally and provide a critical remote alert as approved by DOHS.

**A. Materials:** Piping and distribution systems serving laboratories and ARE, (with the exception of where used only as a driving/instrument gas) shall be designed and constructed for cleanliness provisions suitable for oxygen service. Gaseous applications at Grade 5.0 and higher shall utilize 20Ra or better ASTM G93 Level A clean 316L stainless distribution and components, with orbital weld or VCR/Vacuseal type face seal joints, stainless diaphragm UHP regulators with purge stations, and non-lubricated sanitary/semi conductor UHP ball, bellows, or diaphragm valves modified TFE/PCTFE elastomer as well as central .03 µm particle filters in parallel, and shall be constructed by qualified installers to prevent contamination. See [12.3.8 Ultra-High Purity, Hazardous, and Specialty Gas](#) for additional requirements for such applications.

**B. Codes and Standards:** Gaseous systems shall be designed and installed in accordance with NFPA-55 and CGA guidelines. Refer to [Section 12.5 Veterinary Medical Gas Systems for Animal Research Facilities](#) for related requirements.

### 12.3.8 Ultra-High Purity, Hazardous, and Specialty Gas

UHP and specialty systems (of varying grades) may be required for specialty laboratories and special lab equipment (e.g., LC/MS and NMR's). Such systems shall additionally comply with Semiconductor Equipment and Materials International (SEMI) and ASTM standards as appropriate to the grade of gas. UHP systems shall be located near the point of use and shall not serve other areas. An independent, qualified third party shall provide system quality assurance and validation throughout construction including but not limited to materials and methods verification, particle count, hydrocarbon, moisture, purity, and oxygen at each use point and for source and purge gases, filters, and purifiers. The specific grade of gas to be delivered of UHP systems (grades 4.5 and higher) shall be clearly delineated, as well as impurity limits for particles, hydrocarbons, moisture, and oxygen. Gas sources for testing and purging shall be individually (not batch) certified. Gas racks shall be semiautomatic or automatic type and shall include purge and evacuation controls for Grade 5.5 and higher. Failure mode under power loss shall be reviewed with the program. A multi-contaminants purifier specific to the application and with purge ports and change-out valving shall be provided. Valves shall be diaphragm type, UHP, except bellows shall be used where required by application. Fully automatic gas cabinets shall be used for toxic, reactive, and corrosive gases. Systems and components shall be reviewed with users and approved for the application. Where corrosive or hazardous gas systems are being provided, notify the PO for a project-specific safety and technical review. All UHP, toxic, and hazardous systems shall be subject to a sensitive leak test (helium), in addition to high pressure testing. The A/E shall specify criteria for installers of such systems.

# Section 12.4

## Laboratory Vacuum Systems

---

### Contents

12.4.0 Introduction

12.4.1 General Design Requirements

12.4.2 Laboratory Vacuum Quality

12.4.3 Laboratory Vacuum System Equipment

12.4.4 Laboratory Vacuum Distribution

12.4.5 Laboratory Vacuum System Testing



## 12.4.0 Introduction

Laboratory vacuum systems are utilized for numerous in-lab applications such as transfer of liquids (aspiration) and filtering, and depending upon the vacuum level required, sample desiccation, degassing, gel electrophoresis, and solvent-extraction procedures. Some procedures, e.g., drying/freezing and solvent recovery applications typically require high (deep) vacuum and are therefore provided locally.

### 12.4.1 General Design Requirements

**A. Noncentral Systems:** Vacuum systems for lethal, toxic, or highly corrosive or explosive gas applications, locally applied systems (e.g., diaphragm pumps and associated solvent/vapor condensing and recovery systems), and systems intended for high vacuum applications are not applied as central systems.

*Rationale: Central arrangements for such systems can be cost prohibitive and pose safety risks, especially where vapors are not fully condensed or incompatible vapor stream mixing occurs.*

**B. Central Systems:** A dedicated central laboratory vacuum system is required to serve each laboratory facility. Laboratory vacuum systems shall be completely independent of medical (clinical) systems or other system applications. An animal surgical vacuum system and anesthetic gas scavenging system may also be required for ARF areas and shall not be combined with laboratory vacuum or other system applications (refer to [Section 12.5 Veterinary Medical Gas Systems for Animal Research Facilities](#)).

*Rationale: Medical and veterinary medical vacuum systems are life-safety and critical systems subject to a number of requirements that differ from lab vacuum.*

**C. Suitability:** Each vacuum system application shall be evaluated for the type of substance or products being evacuated and for the appropriate application of equipment and materials.

**D. Hazardous Vacuum, Differing Programs/Dissimilar Fluid Applications:** Central systems shall not be applied for serving solvent extraction or hazardous vapor applications between labs under differing programs or for other dissimilar fluid applications. For repetitive non-biohazardous demands under the same program (typically within the same lab), the use of localized modular vacuum networks or individual pumps may be used. The design shall demonstrate satisfactory system equipment and vapor/condenser/trap arrangements, use of an approved permanent collection tubing/joint construction (weld/fusion or VCR joints of materials such as stainless steel or PTFE), and appropriate solvent/waste and exhaust handling.

*Rationale: Differing chemical vapors introduced into a central system may be incompatible and result in safety hazards and disposal issues at the equipment. Furthermore, the vacuum levels, leak tightness, cross-contamination controls, and stability required for many solvent extraction applications are not economically applied centrally in lab buildings with differing applications.*

**E. Exhaust Line Termination, Slope, and Backpressure:** The exhaust from vacuum systems shall be discharged outdoors above the roof a minimum of 7.6 m (25 ft.) from any air intakes, building openings or areas where persons may normally be present. Exhaust lines shall be sized to minimize backpressure on the pump and sloped upwards towards the roof terminal without trapping to ensure full drainage back to the tank seal vessel. The exhaust shall be protected from entry of insects, water, or debris and shall be enlarged prior to roof penetration, and turned down above the roof with a sufficiently sized non-corrosive screen to avoid backpressure or frost restriction. An isolation valve shall be installed at the exhaust port to permit isolation of each pump and separator. Where dry systems are approved, an adequate drip pocket and drainage shall be provided. Vacuum exhaust sizing shall include at least 20% overage capacity in sizing.

***Rationale:** These requirements are to prevent unsafe blockages of vacuum exhaust and creation of unacceptable backpressures. Liquid accumulated in the exhaust riser of a liquid ring system can drain back safely to the seal liquid receiver.*

**F. Isolation Valves/Disconnect Means:** Independent isolation valves and disconnect means shall be provided to permit service of each vacuum pump while maintaining the system's operation. The location of isolation valves, decontamination ports, and filtration (where applied) shall be coordinated to facilitate maintenance and service continuity.

**G. Biohazard and Incidental Contaminants Protection:** Each central vacuum system shall include a secondary means of protection at the vacuum equipment to help protect system maintenance workers from potential biohazards or incidental fluids. The provision of decontamination ports or filters at central equipment shall not take place of suitable condensing (cold) traps and separators or point of use protection.

***Rationale:** Proper laboratory standard operating procedures (SOPs) require user-applied disinfectant traps and in-line filtration at points-of-use, which serve as primary system protection. However, due to the nature of the central system application and the potential for improper trap or filter application (including potential for defective filtration), maintenance issues, and variability of practices with numerous users, a potential hazard may be undetected at the time of service.*

The following approaches are acceptable for typical lab vacuum:

- 1. In-Line Filters:** Where liquid ring or approved vertical screw liquid handling vacuum pumps are utilized and a liquid separator is provided (e.g., a cyclone separator or knock-out pot), or where the receiver is configured to serve as the liquid separator at the vacuum plant, an in-line filter may be provided upstream of the vacuum pump (at the connection to the building vacuum piping system), but downstream of the receiver/separator. Filters at main lines shall be arranged

in N + 1 (in parallel) configuration to allow continued system operation, and shall include isolation valves and decontamination ports.

***Rationale:** Properly maintained, filters provide constant protection to the vacuum pumps from any potential biohazards. Valved decontamination ports are required so that filters can be properly decontaminated or replaced. Placement of the filter downstream of the separator (or receiver) is necessary to maintain system flow and prevent blockage due to trapped liquid that is occasionally ingested into the system.*

- 2. Decontamination Ports:** Where liquid ring or vertical screw liquid handling pumps are utilized, in lieu of (or in addition to) the above in-line system filtration, appropriately arranged decontaminations ports and isolation valves may be provided for BSL-2 applications and are required for any component upstream of the main filtration. The decontamination ports shall be arranged on each side of each pump and tank and shall include isolation valves. Ports shall be located to facilitate liquid or gaseous decontamination as approved for the application. Port location shall permit complete flooding of the pump assembly or component to be decontaminated with disinfectant in the event of pump failure and without disturbing remaining system operation. In the case of liquid ring pumps, the arrangement shall allow for draining of fluid to a level at or below the centerline of the pump shaft. All decontamination ports shall be fitted with tight-sealing threaded caps or plugs to prevent a direct opening in case of accidental operation of a valve.

***Rationale:** Prior to opening a pump or component for repair or replacement, decontamination ports can be used with liquid handling pump arrangements to properly disinfect. In the event of pump malfunction, arranging the decontamination ports at sufficient elevation above the pump seal will allow for flooding of the components with disinfectant fluid.*

3. **Filters/Separators:** Where a non-liquid ring or non-liquid-handling-type pump is permitted, in-line hydrophobic filtration shall be provided at the system inlet to the pump, downstream of a liquid separator. A liquid separator (e.g., a knock-out pot or cyclone vacuum separator) is required for these applications, unless it is demonstrated that the pump can operate without any damage under conditions of ingested liquids. The separator method used shall not require opening or routine intervention. Systems that cannot be effectively flooded with gaseous/vaporous or liquid disinfectant (e.g., oil-sealed systems [if allowed]) must be protected with in-line hydrophobic type filtration. Separators are required for such systems, and must not rely on hydrophobic filters (which can be blocked by liquid). A receiver configured to act as the separator may be used for liquid-handling pumps.

**H. Drainage Connections:** Vacuum system arrangement and filters shall be in conformance with drainage connection requirements of [Section 8.4 Drainage Systems](#), to maintain sealed, normally closed systems for unprotected, potentially contaminated waste.

**I. Codes and Standards:** Systems shall be in accordance with ANSI/ASME B31.9. Brazing and welding shall be in accordance with section IX, ASME Boiler and Pressure Vessel Code or ANSI/AWS B2.2 Standard for Brazing Procedure and Performance Qualifications. Systems shall be rated for full vacuum and working pressure of at least 1,034 kPa (150 psi).

***Rationale:** Braze/weld quality is an important factor in controlling leakage rates that directly impact system operating efficiency, corrosion control of joints and filter life.*

**J. Quality Control:** The A/E shall include a quality control plan in project specifications for system installations that may be hazardous, high vacuum, or of other safety concern.

**K. Turret Selection:** See [Section 8.2](#)

## 12.4.2 Laboratory Vacuum Quality

**A. Vacuum Quality:** The laboratory vacuum system shall be capable of maintaining a vacuum of at least 610 mm (24 in.) HgG (150 Torr/mm HgA/80% vacuum) at the inlet terminal farthest from the central vacuum source under peak demand. The central system pumps shall be selected for an operational range of 660 mm (26 in.) HgG (87% vacuum) minimum leaving the pump system after accounting for any main line filters and appurtenances) and shall not exceed 700 mm (27.5 in.) HgG (61 Torr/mm HgA/92% vacuum) unless required by the program. If vacuum levels deeper than 710 mmHg (28 in.) HgG (94% vacuum) are required, it shall be generated locally with special vacuum pumps to serve the specific area of need.

***Rationale:** These vacuum levels provide flexibility and reasonable performance for common applications. Excessively high vacuum levels are not cost or energy-efficient, can lead to the need for additional equipment (e.g., vacuum regulators to alleviate vapor pressure concerns).*

## 12.4.3 Laboratory Vacuum System Equipment

**A. Vacuum Pump Type:** For central lab vacuum applications, pumps shall be of the single- or multiple-stage, partial recovery, liquid ring type, designed so as to be suitable for use in biomedical and chemical laboratory applications (as opposed to general healthcare systems), constructed of stainless steel with corrosion-resistant materials compatible with laboratory chemical process vapors including condensable vapors. Galvanized steel and other materials susceptible to corrosion shall not be utilized in lab vacuum systems, including for pump equipment, manifolds, and tanks. Shaft seals shall be mechanical seal type (single or double as determined appropriate) except that any toxic/corrosive or known hazardous application shall be flagged to the PO for review, and provided with equipment that is hermetically sealed liquid ring type, which incorporates either a magnetic coupling or canned motor design; and with

the pump system specifically designed for the fluid application. Pumps shall automatically revert to once-through operation (and alarm) upon failure of adequate cooling flow. The vacuum system shall be impervious to saturated gas mixtures, occasional ingestion of liquid slugs, and minor particulate without requiring intervention. Operating efficiency and seal liquid temperature shall be evaluated when determining pumps and quantity of pump stages. Liquid or air-cooled configurations may be used provided partial recovery operation is maintained.

***Rationale:** Liquid ring vacuum pumps provide proven durability and minimal maintenance in laboratory vacuum applications with low operating temperatures and broad flexibility for use with a wide range of chemical/flammable fluids, solvents, vapors, and potentially contaminated or corrosive liquids. NIH defaults to partial recovery liquid ring for inherent equipment benefits in reliability, safety, and low maintenance.*

**B. Seal Water Conservation:** Limiting seal water makeup and avoiding once-through operation are desirable for water conservation. Makeup water flow reduction of greater than 50% below once-through operation mode shall be applied only after evaluation to ensure unacceptable concentrated seal liquid is not discharged under actual use conditions, and to avoid conditions likely to result in premature failure. Where determined acceptable to address corrosion, biofouling, suitable waste streams, and adequate cooling is provided; makeup not less than 20% the required once-through flow rate may be used.

**C. Reclaimed Water Sources:** Where sufficient water quality is available from reclaimed water sources, such water shall be utilized for liquid ring vacuum pump seal makeup.

**D. Solvent Recovery and Hazardous Fluid:** Solvent recovery and other potentially hazardous applications shall be addressed locally. Such systems shall utilize dedicated full-recovery liquid ring systems (typically utilizing the solvent as the seal liquid), particulate filtration, and at least double mechanical seals appropriate to the application and hazard (hermetic motor or magnetic drive typically required). Acceptable alternatives for these specialized chemical applications

include double-diaphragm pumps (with diaphragm safety systems) and vapor condenser arrangements. Vertical screw completely dry running pumps may also be accepted for some applications, with approved seal designs and traps.

**E. Alternative Vacuum Technologies:** With the exception of vertical screw units, alternatives to partial recovery liquid ring systems shall be justified by a risk assessment including a facility chemical usage compatibility, waste disposal, and life cycle cost analysis. Full-recovery liquid ring systems are not acceptable. For lab applications, unless partial recovery liquid ring pumps are used; pumps shall be completely dry type, vertical screw, variable pitch type, with synchronous motor drive and no mechanical seals or lip seals. Vacuum pumps shall be fully compatible with liquid slugs and corrosive vapors without reliance on a knock out pot or separator, and shall include an inert ( $N_2$ ) gas purge arrangement. The  $N_2$  supply shall include automatic switchover with supply status alarm monitoring and be sized for at least thirty days operation with a secondary reserve of at least seven days. The speed of each pump shall be automatically controlled and rotor clearances monitored. Equipment shall be suitable for varied and non-constant loading and shall be auto-ignition resistant with an exhaust temperature that does not exceed  $150^\circ\text{C}$  ( $300^\circ\text{F}$ ) and shall include a liquid cooling system to provide temperature stability throughout the entire unit. The equipment shall allow for operation under total flooded conditions (as may be necessary for decontamination). Equipment shall not require routine maintenance at a frequency more often than 20,000 hours. Systems shall be arranged to operate continuously (low speed) to protect from condensed vapors. Materials of construction shall be not less than forged stainless steel rotors and ductile iron or stainless steel housing. Full ballast receivers are not typically required with vertical screw pumps, however a small receiver shall be provided to allow for capture of minor liquids.

**F. Auxiliary Equipment Materials and Selection:** The liquid separator or knock-out pot (where provided) shall be constructed of corrosion-resistant materials, of at least 300 series stainless steel. Where receivers are arranged at a point on the system to function only as ballast tanks, corrosion-resistant material of at least galvanized steel or holiday-tested suitable epoxy-coated tanks may be used (stainless steel recommended). Receivers shall only be sized as required to perform the



required liquid separation and system vacuum stabilization (ballast) function, and in consideration of the system, pump, and controls technology. For any case other than once through or partial recovery liquid ring systems, the minimum receiver material shall be 316 stainless. Materials/components shall be ASME code constructed.

***Rationale:** Receiver/separators (including knock out pots and similar) are subject to direct exposure to the seal liquid and process stream, which in some cases can become concentrated, corrosive, or even acidic. Conventional steel receivers are subject to premature failure due to corrosion.*

**G. Hermetic Seal Monitoring Systems:** Canned motor pumps and other hermetically sealed designs (where provided) shall include monitoring systems including liquid level, motor and pump temperature, rotor position, rotation/phase sequence, and hermetic seal stator chamber pressure.

**H. Reliability, Redundancy, and Operating Economy:** Systems shall be arranged to ensure reliability and continuous service so as not to disrupt facility operations. Components shall be compatible and arranged for unobstructed flow paths. The system design criteria shall be for 100% of the system peak load to remain upon failure of any one pump. A normally closed bypass shall be provided around receivers.

**I. Variable Speed Drive Systems/Capacity Split:** Variable speed drive systems should be considered, or a load-responsive capacity split (e.g., triplex or quadruplex) to maximize efficiency. Independent VFD's are required for each motor except that VFD load sharing may be used so long as equipment defaults to across-the-line starting automatically and maintains safe operation with a VFD fault.

**J. Standby Power:** Where it is determined that loss of the vacuum system could reasonably pose risk to research or per program requirements, standby power shall be provided.

**K. Makeup Water Quality:** The A/E shall ensure suitable makeup water quality and provide any required water treatment appropriate to the specific project location. Refer to manufacturers written requirements and

perform/obtain water quality analysis (typically hardness) as required. Provide water softening and/or scale control as required based upon local water quality.

***Rationale:** Excessive water hardness or other incompatible water conditions can result in significant maintenance issues or potential pump failure.*

**L. Automatic Drains:** Automatic drains (if used) shall be designed to prevent disruption of the system vacuum, prevent subjecting the drainage system to negative pressure, and seal tightly after each operation.

**M. Controls, Alarm and Automation:** Local control systems with system operating status and alarm condition readout shall be provided at the equipment, and lead-lag, automatic alternate and minimum-run functions shall be included. A remote fault signal to the BAS shall be provided, though it is acceptable to limit this to a single general fault alarm for each system source unless more stringent central monitoring is required.

**N. Vacuum System Filters:** In-line filters for microbial protection shall be as determined by the program. The following requirements apply:

1. Pipeline filters shall be of at least HEPA efficiency or sterilizing grade-absolute rated for aerosolized virus particles in high humidity gas, ASTM F838 or suitable equal, and shall be bacteria rated in liquid streams at 0.2 microns (or less), a leak-tight frame or cartridge design, and corrosion-resistant seals to avoid bypass leakage. PTFE, PVDF, or stainless steel moisture and corrosion resistant construction, and hydrophobic as required for application. Housings shall be at least 316 stainless steel or equivalent corrosion-resistant metal compatible with system application, and of gas-handling design. N + 1 is required (in parallel) for main line filters.
2. Each filter selection shall have a total pressure drop through the filters and housing that does not exceed 12.5 Torr (0.5 in. Hg) at design flow under operating conditions, and less where practical for energy savings. Filters shall be readily accessible and arranged to permit decontamination, validation, drainage, and servicing.

3. Isolation valves and decontamination ports shall be provided at filter inlet and outlet, with a tight-sealing threaded cap. A valved and capped drain port shall be provided for pipeline filters on vacuum systems if such port is required. Filters shall be placed only in the vertical, upright position and arranged to preclude trapping of liquid. A valved decon port arrangement shall be provided to serve each receiver, liquid separator, or similar component that is located upstream (house side) of the mainline filtration).
4. A vacuum level sensor shall be provided on the house side of the filter, or differential pressure sensors across filters to alarm to BAS for low system vacuum or pressure loss greater than 76 mm (3 in. Hg).

**O. Valves:** Full way valve type is required, designed to be leak tight under vacuum operation. Butterfly type valves designed for vacuum service may be used for sizes 100 mm (4 in.) and larger. Diaphragm type may be used for all sizes. Seat/seals for valves in vacuum service to be Viton/FKM or PTFE (not reinforced). For high vacuum, utilize bellows type valve seals suitable to the vacuum level or an approved equivalent. Approved gate valves for vacuum service may also be used for high vacuum. Full port ball valves may be used with seals designed so as to be suitable for the vacuum service without leakage.

**P. Signage:** A sufficient warning sign or sticker shall be provided at vacuum system filters and at the system receiver and pump: “Obtain Clearance before Opening for Service, PPE required.”

**Q. System Cleanliness:** The A/E shall specify parameters to maintain system cleanliness prior to operation. Newly installed vacuum systems shall be purged with nitrogen or compressed air prior to installation of filters. Where filters are being utilized, systems with brazed joints shall be joined with nitrogen or argon purge and other precautions to minimize internal particulates. Soldering and ferrous piping is not an acceptable joint method in lab vacuum systems.

***Rationale:** Particulates will induce excessive pressure loss and loading on the system filters (where provided). Soldering is not sufficiently clean or leak-tight for the level of vacuum at which these systems operate. Internal contamination from fluxes, etc., could be reactive to system vapors.*

## 12.4.4 Laboratory Vacuum Distribution

**A. Sizing:** The central lab vacuum system distribution and pump sizing shall be based on 0.25 standard l/s (0.5 cfm) at each vacuum inlet or terminal. Diversity factors may be used if they can be properly justified. Diversity for specific equipment shall be considered separately from factors applied to turrets. The pressure drop of the system associated with pipe sizing shall not exceed 10% of the source system absolute operating pressure. The A/E shall properly consider the gas load and actual expanded capacity (actual cubic feet per minute [ACFM]).

***Rationale:** At higher system vacuum levels required of laboratory systems (e.g., as compared to typical surgical/clinical/medical systems), the effect of undersized piping and leakage can have substantial impact on delivered vacuum quality, equipment size/operating efficiency, and capability to withstand system gas loads (leaks and simultaneous demands). Because system inlet vacuum is typically 660 mm Hg (approximately 100 Torr absolute), system pressure drop should not exceed approximately 10 Torr (0.4 in. HgA) for most applications.*

**B. Distribution Arrangement:** Vacuum system distribution shall conform to requirements for pressurized risers as outlined in [Section 8.1 Plumbing General Requirements](#). Runouts from horizontal piping serving drops to inlets should be taken off above the centerline of the main or branch pipe and rise vertically at an angle of at least 45° from vertical.



***Rationale:** Vacuum runouts are taken off above mains to minimize liquid seepage from turrets and to contain liquid slugs in the event such are induced.*

**C. Dips and Traps:** Vacuum systems shall be installed free of dips and traps.

---

## 12.4.5 Laboratory Vacuum System Testing

A standing pressure test shall be performed after installing the vacuum system, including station inlets, but before attaching the vacuum lines to the vacuum pumps, receivers, and alarm switches. The pressure test shall be made by subjecting the system to a pressure of 1,035 kPa (150 psig) by means of oil-free, dry nitrogen. After allowance for temperature variation, the pressure at the end of 8 hours shall demonstrate the system leak-tight. Vacuum decay (pressure rise) testing is recommended but not required. Additional test criteria, including sensitive leak tests shall be provided for high vacuum systems and systems carrying hazardous vapor. Lines shall be purged/blown clean prior to installation of equipment. Filters (where provided) shall be validated as an assembly for efficiency and leak integrity in situ, and results shall be forwarded to the PO. The approach to filter maintenance and integrity testing and validation shall be documented in the BOD or SOP's. Typically water intrusion testing, forward flow diffusion, or bubble point methods are utilized.

# Section 12.5

## Veterinary Medical Gas Systems for Animal Research Facilities

---

### Contents

#### 12.5.0 Introduction

#### 12.5.1 Systems Configuration Overview

#### 12.5.2 General Design Requirements

##### 12.5.2.1 VMGS Capacity, Reliability, and Continuity

##### 12.5.2.2 Alarms and Valving

#### 12.5.3 VMGS Equipment

##### 12.5.3.1 Source Equipment Location

##### 12.5.3.2 Distribution Sizing and Requirements

##### 12.5.3.3 Installation

#### 12.5.4 Quality Assurance and Systems Verification

#### 12.5.5 VMGS System-Specific Additional Requirements

##### 12.5.5.1 Veterinary Oxygen

##### 12.5.5.2 Veterinary Medical Air

##### 12.5.5.3 Specialty Gases

##### 12.5.5.4 Veterinary Surgical Vacuum Systems

##### 12.5.5.5 Veterinary Anesthetic Gas Scavenging Systems

###### 12.5.5.5.1 Veterinary Anesthetic Gas Scavenging System-Common Requirements

###### 12.5.5.5.2 Veterinary AGSS Type-Specific Requirements

#### 12.5.6 VMGS Outlets and Terminal Unit Location, Quantity, and Placement

#### 12.5.7 Barrier and Quarantine Facilities

## 12.5.0 Introduction

This section addresses compressed gas and vacuum systems within an animal research facility (ARF). Veterinary gas systems (VMGSs) are utilized for respiration, anesthesia/analgesia, treatment, and life-support activities and are required for a variety of invasive and non-invasive procedures and associated clinical support. Such systems are inclusive of associated vacuum and anesthetic gas scavenging systems.

### 12.5.1 Systems Configuration Overview

**A. General Requirement:** Systems shall not be shared with other lab or human medical applications. Systems may be located centrally or local to serve major program areas. Systems are designed and installed with many similarities to medical gas systems, including maintaining all precautions to ensure safety, continuity, and reliability of the uncontaminated gas and vacuum supply. Critical functions are monitored both locally and remotely.

### 12.5.2 General Design Requirements

**A. Systems Use:** VMGS shall be used only for animal medical applications. Where gas systems are required within the ARF that will not be utilized for veterinary medical applications, such systems shall comply with the requirements of [Section 12.3 Compressed Gas and Cryogenic Systems](#). Examples where conventional laboratory gas and vacuum systems may be applied within the ARF include compressed air or nitrogen utilized strictly for powering equipment or instrumentation, vacuum service to equipment where not used for surgical or animal contact purposes (e.g., fume hoods), lab spaces located within the ARF, and other non-contact, non-invasive applications.

**B. Minimum Standards:** Services administered to animals shall be at least USP–NF grade and in accordance with the ILAR Guide and the Public Health Service Policy for Humane Care and Use of Laboratory Animals.

***Rationale:** It is not necessary to maintain VMGS standards for systems delivering process fluid that does not directly affect (contact) the animals. Lab systems do not meet requirements for VMGS use in multiple ways and their use in lieu of proper dedicated VMGS could induce hazards to safety and risk to research.*

**C. Basic System Requirements:** VMGSs shall be designed to effectively protect the safety, purity, and uninterrupted supply so as to prevent cross-connections and prevent introduction of variables that may compromise the animal’s health or affect the integrity of research.

**D. Dedicated Systems, Veterinary Medical Use Only:** VMGS shall be dedicated for animal medical applications, independent of process piping systems serving laboratories, pathology, and other functions, and shall be provided with clear and specific labeling nomenclature. VMGSs shall not be extended to laboratory areas or other areas beyond the associated veterinary program area. Independence of systems shall include all components, including the source equipment. Where VMGS is required at a limited, remote laboratory; local services may be provided. The word “Veterinary” shall be included in all gas labels.

***Rationale:** This is to prevent misuse and cross connections of VMGSs and to prevent potential impacts associated with the less-supervised and differing operating procedures and equipment configurations associated with other systems.*

**E. Euthanasia Gases:** In cases where euthanasia gases might be permitted (e.g., for small rodent application) refer to PHS Policy and American Veterinary Medical Association (AVMA) Guidelines for additional requirements.

**F. Requirements:** VMGSs shall be designed, installed, tested, verified, and constructed entirely of materials in accordance with requirements for Category 1 Medical Gas and Vacuum Systems as per NFPA-99 or ISO 7396-1, and as modified in this section. In general, NFPA/ISO medical gas provisions with regard to cleanliness, minimum source supply, equipment design, continuity and reliability apply. Unless specifically stated in this

section, reference to NFPA-99 is intended to refer to Category 1. Each gas supply and handling system shall be of at least medical (USP–NF) purity and shall be controlled and regulated.

**Rationale:** Other NFPA-99 “categories” covered by these standards are neither intended nor directly suitable for VMGS in ARF applications. VMGS requires human quality services but are operated differently.

**G. Multi-Use Program Space:** Where a gas system serves a program space that may be utilized to serve clinical procedures for humans and animals (e.g., certain imaging facilities), any permanent gas system provided shall be consistent with the predominant building function and usage of the space. The minority needs shall be served from independent systems or point of use equipment, and in consultation with the NIH DOHS. Systems shall be clearly labeled and constructed with terminal outlets labeled and keyed to prevent potential cross-contamination.

**H. Electrical Power:** VMGSs shall be served by building standby power in accordance with NFPA-99 or ISO-7396 configurations including ensuring that electrical wiring serving alarms and VMGS components are installed in accordance with the provisions of NFPA-99.

**I. Gas Temperature:** Delivered gas temperature shall not pose risk of injury or pain, and shall typically be at approximately ambient conditions and in no case exceed 38°C (100°F). Over-temperature limits are required for CO<sub>2</sub> vaporizers and other equipment that could pose hazards.

**J. Pipe Routing:** VMGS piping, especially oxygen, shall not be routed through hazardous areas or potential sources of ignition or mechanical damage, including but not limited to loading docks, boiler rooms, generator areas, electrical rooms, uncontrolled areas, high containment (except where serving this space), etc.

**Rationale:** Full conformance with NFPA-99 and ISO 7396 is not required in consideration of basic functional differences. While gases must be clean, uncontaminated, reliable, flexible, and maintainable with minimal disruption, the requirements applicable in a research environment

are often not subject to the same variables of operation for which medical gas systems are intended to address. As VMGS do not fall directly under NFPA-99 Category 1 scope, the A/E must coordinate between disciplines to ensure alarm, sensor wiring, remote signaling, circuiting, and similar provisions are designed in conformance with the intent of NFPA-99 Category 1 to ensure reliability, continuity, and maintenance needs are met.

### 12.5.2.1 VMGS Capacity, Reliability, and Continuity

**A. Source Supply:** Source supply systems shall consist of an automatic cylinder or bulk supply system (including generating equipment), each with an appropriate redundant secondary supply source automatically feeding to a controlled distribution system from the source to each use point.

**B. Reserve and Backup:** System primary/secondary supply configuration, and the need for any additional remote backup reserve shall be based on a risk assessment during planning and shall not be less than required herein.

**C. Supply Continuity:** Systems shall be designed to provide continuity of supplies under normal and a single-fault condition. Electrical failure shall not interrupt critical VMGS supplies. The type, capacity, and location of the system primary and secondary supply, and need for any additional remote reserve backup or maintenance standby backup shall be based on an assessment conducted in accord with the program during planning. Provisions to ensure the continuous availability of critical VMGS services shall be incorporated in planning and design to prevent loss of service in the event of an unplanned failure or required system modification.

**Rationale:** Unexpected or unplanned loss of critical VMGS could pose an unacceptable risk to the animal. It may be justifiable to provide redundancy/source reliability provisions beyond that provided from the secondary bank of the supply manifold or redundant equipment. This can often be accomplished with a one-day reserve backup supply or in some cases through program

*SOPs (e.g., availability of point of use portable vacuum pumps and cylinders to supplement in the event of a catastrophic electrical primary and standby power failure). The needs for such accommodations above DRM requirements are individual program, risk-assessment dependent.*

**D. Mechanical Equipment:** Where mechanical equipment and their associated control arrangements are provided as the supply source serving critical systems, NFPA-99 Category 1 or ISO 7396 described redundancy configurations are required.

**E. Supply Capacity:** Compressed gas VMGS supply system capacity and configuration shall be in conformance with [Section 12.3 Compressed Gas and Cryogenic Systems](#), except that components listed to NFPA-99 or ISO 7396-1 are required. A secondary supply source shall be provided and shall operate automatically to supply the distribution system if the primary supply becomes exhausted or fails. In the case of compressed VMGS, unless a separate high-pressure gas reserve is provided, the secondary supply shall be high-pressure gas. There shall be a minimum of two cylinders in a primary or secondary manifold.

**F. Emergency Reserve:** Where a remote bulk system or other supply source remote from the building (including cryogenic source) provides oxygen supply, a remote high-pressure gas emergency reserve (at building) of at least one day capacity shall be provided in addition to the primary/secondary supply source or any associated reserve.

*Rationale: Remote (away from building) sources can be subject to extended risks of disruption, including piping breakage or other uncontrolled malfunctions. Cryogenic systems are subject to evaporation or other losses.*

**G. Availability of Secondary/Reserve/Backup Supply:** Secondary supply and reserve or backup supply connections and equipment shall be arranged to prevent discharge of the reserve cylinders during normal operation or other loss of gas due to failure of the bulk tank, primary supply or piping (e.g., due to an over-pressure relief condition), and shall be accommodated through the use of an automatic control valve arrangement not dependent on an external power source. Check valves and regulator arrangements may be used.

**H. Elevated Demands:** Loadings for VMGS systems shall consider peak demands and facility emergency response or disaster mitigations plans.

*Rationale: Certain gases (e.g., CO<sub>2</sub>) may have an elevated demand associated with disaster response or other emergency conditions. The program requirements should be consulted to determine the requirements for such surge loads.*

**I. Sizing and Diversity:** VMGS demand loads shall be determined following the same criticality as per an NFPA-99 Category 1 or ISO 7396 system, except that the additional loads associated with “convenience” outlets may be diversified through evaluation of the program requirements. Diversity shall be applied only for non-surgical, non-recovery areas, where justified through consultation with the program staff, but shall in no case be less than one outlet/terminal unit count (without diversity) for every room where outlets/terminal units are provided. Actual consumption shall be determined by analysis of application, considerations of simultaneous use, maximum staffing, and throughput. The flow rates of NFPA-99 or ISO 7396 at each outlet shall be used as a minimum unless otherwise justified.

*Rationale: Consultation with the program staff must occur to determine use planning as the arrangement and sizing of the VMGS must not limit the intended flexibility of the facility. The term “criticality” refers to the implementation of diversities in accordance with typical practice in sizing medical gas systems. It is important to recognize the operating methods utilized in ARFs differ from that applied in a hospital. In addition, multiple outlets are often required for program flexibility within the same room, but may or may not be indicative of an additional or simultaneous demand.*

**J. Future Taps and Backfeed Insertion Points:** Backfeed insertion points consisting of a valved and capped pipe tap shall be provided for large facilities where VMGS extends through multiple floors. Where known future expansion or phasing is to occur, valved and capped lines shall be provided in a manner that can be purged to prevent cutting into systems.



### 12.5.2.2 Alarms and Valving

**A. Alarms and Valving:** Separate master and area alarm panels and wall-mounted/user accessible zone valves are not required (except for provision of a master accessible oxygen source shut-off per NFPA). A single “combination type” alarm panel may function to serve both as a master alarm and area alarm, or redundant alarms shall be provided. The VMGS alarm configuration shall provide visual and audible alert at the panel location and remote alert to personnel responsible for the program area through the lab/ARF monitoring system and through the BAS to responsible personnel per the program requirements. Alarms shall be both audible and visible to the extent required per NFPA-99 or ISO 7396.

**B. Alarm Parameters:** Alarms shall monitor key parameters as mandated under NFPA-99 or ISO-7396 for a similar Category 1 health care facility.

**C. Alarm Operation:** The combination alarm panel (or in the case of multiple panels or separate master/area alarm panels) shall facilitate local audible and visual alerts and remote two-point alert, and the remote alerts shall operate upon alarm panel malfunction, disablement, or power loss. Acceptable alert points shall be at the monitored alarm panel location (typically in a monitored ARF control area corridor, but not in a contained room), along with remote alerts to two points; one being the ARF monitoring system where provided (or if not provided to another lab-monitoring system or system to page/alert to 24 hour/365 day responsible multiple animal supervisory staff), plus a second program-defined location, typically the BAS system.

***Rationale:** Although constant monitoring by responsible and reactive personnel is required, the configuration and operation of ARFs and response conditions vary from those applicable to hospitals and other medical facilities for which the medical gas standards are designed. Adequate monitoring can be accomplished through substantially equivalent arrangements by alerting the appropriate program staff to directly intervene or take necessary mitigating actions to protect research and animal safety.*

**D. Fail-safe Design and System Alarms:** VMGS systems and equipment shall be arranged to prevent single point failure and to provide alert of failures and abnormal

conditions that may occur from the supply source thorough to the use point. The VMGS alarm panel shall at a minimum monitor line pressures, status of supply equipment, primary supply/reserve equipment-in-use status, and shall also indicate the presence of a general fault and major equipment fault or source (plant) emergency. Except for very small and localized systems, at least two monitoring points shall be provided throughout the system to alert to a system emergency. Pressure shall be monitored at central supply mains or risers, downstream of the gas manifold and any associated treatment or filtration, but not within an individual isolated program. Alarm sensors shall be provided to protect each major areas of the facility and shall annunciate at VGMS alarm panel.

***Rationale:** Alarm sensors that fall within an individual program area must not be the only initiating point, so that as the occasional maintenance or renovation of one area of the facility shall not result in loss of alarm/monitoring for remaining areas. The use of source alarm indication and inclusion of at least one additional strategically applied pressure-sensing location such as on corridor mains accomplishes the intent of this requirement.*

**E. Alarm Application and Valve Monitoring:** Individual area or local alarms are not required to serve each isolation valve or program area unless required by the program; however, large facilities shall be provided with a second set of alarm pressure sensors located at a separate remote main or riser in accordance with program requirements and as approved by the ORF to ensure effective monitoring of the supply to the entire system. Alarms shall be configured to provide independent/separate annunciation for each system type. Alarms sensor points for anesthetic scavenging vacuum and veterinary surgical vacuum shall not be combined.

**F. Valving and Alarm Sensors:** Valving locations and associated alarm-monitoring points shall conform with either NFPA-99 Category 1, ISO 7396, or with requirements of the DRM for other pressurized systems, with the alarm downstream of the isolation valve for pressurized mains. Service lines to individual rooms are not required to be provided with individual alarm pressure sensors where such valves are located in a secure location and provided with warning tags, where valves are



located in readily accessible wall-mounted zone valve boxes provided they are located only within appropriately restricted access corridor, or where valves are otherwise locked open and labeled or fitted with tamper switches. Valves shall be protected from tampering and unauthorized operation. A source valve is required for all systems, and this requirement includes vacuum and waste anesthetic scavenging systems. Alarm sensors serving system mains shall not be located on the downstream side of isolation valves to remote areas such that activation of the isolation valve would defeat the monitoring of supply to active use points. Additional alarm sensors are required to monitor system pressure in various program areas where isolation valves may be present.

***Rationale:** While full conformance with NFPA-99 Category 1 is not required, these systems serve life support functions for the animals and critical research. Large facilities with multiple mains or risers must include additional alarm monitoring points to ensure systems are constantly monitored and that pressure sensors can be located far enough from the supply system source to provide effective building monitoring yet without being subject to loss of protection for the facility system if a respective pipe line is isolated for repair or renovation.*

### 12.5.3 VMGS Equipment

**A. Manifolds:** Manifolds for VMGS gases shall be fully automatic switchover type, NFPA-99 or ISO 7396-1 compliant, clean for oxygen service, and provided with alarm monitoring as per NFPA-99, including status of reserve in use, reserve supply low, and abnormal pressure conditions. Manifolds shall be of appropriate NEMA rating for the installed location and verified for adequate flow. Gas heaters are not a substitute for ambient controlled cylinder location. Automatic monitoring of each individual manifold bank pressure (e.g., left side vs right side), upstream of the primary regulator is required. Manifolds shall include a compatible sintered metal filter upstream of the regulator (two in parallel or one for each bank) to protect regulators and distribution systems from particles. Stainless sintered metal shall not be used for oxygen.

***Rationale:** Monitoring of individual bank pressure ensures required capacity is constantly available.*

**B. Auto-Ignition Resistance:** Gas manifolds and other applicable system components shall be designed and listed for auto-ignition resistance when applied for oxygen or flammable gas systems.

***Rationale:** This is to protect from auto-ignition hazards, plausible failure condition effects, including adiabatic compression (e.g., at pressure regulators).*

**C. Emergency Relief Venting:** Gas supply sources shall incorporate protection arrangements to prevent a failure condition resulting in venting of the non-failed component, backup or alternate supply source, or alternate manifold header.

**D. Pressure Sensors:** Pressure transducers or transmitters shall be used where possible instead of pressure switches. Sensors shall be accurate to the measurement unit intervals of the monitored gas.

**E. Valves:** System valves shall be lock-open type and provided with locks keyed to facility standards. This provision is not required for valves located in secure and restricted access areas, valves located within accessible medical-zone valve boxes (with window) that are located in controlled corridors, and valves provided with tamper switches or within valve boxes provided with tamper switches. Neither does it apply to emergency source shut-off valves or to valves at equipment or supply manifolds in secure equipment rooms. All valves shall be clearly labeled with a permanently attached warning tag identifying the service and area served. Valves shall be full-way type.

***Rationale:** Location within the actual ARF program space where animals are handled shall be considered secure, restricted access space. Spaces accessible to unauthorized personnel, public, or outside the reasonable control of animal facility supervisory staff shall not be considered restricted access space.*

**F. Connectors:** Connectors to source tanks/bulk gases shall be labeled and provided with distinct connection types to prevent cross-connections when changing out manifolds.

**G. General Materials:** Materials shall be manufactured for the application and in conformance with ASTM G93, but in no case less than CGA G4.1 compliant.

### 12.5.3.1 Source Equipment Location

Gas supply manifolds (and vacuum equipment) shall be located as required for a Category 1 system in accordance with NFPA 99, in a secure controlled area acceptable to the program users, and accessible for gas delivery.

### 12.5.3.2 Distribution Sizing and Requirements

Refer to Plumbing Design Section 8.1 Plumbing General Requirements, Section 12.3 Compressed Gas and Cryogenic Systems, Section 12.4 Laboratory Vacuum Systems, and NFPA-99 and/or ISO 7396.

### 12.5.3.3 Installation

**A. Codes and Standards:** Systems installation and testing shall conform to NFPA-99 Category 1 or ISO 7396 requirements and procedures, except as modified in this section of the *DRM*. Low vacuum active anesthetic gas scavenging systems shall be tested, commissioned, and verified per ISO 7396-2.

**B. Contamination Protection:** After assembly and up until final cross-connections testing and verification, positive pressure VMGS shall be maintained sealed and under pressure or under purge with clean, dry nitrogen or argon. The use of an actual flow meter and O<sub>2</sub> analyzer is required during all brazing. The A/E shall specify that where systems are renovated or extended, the renovated portion shall not be connected to the existing system until the system has been completed, inclusive of all pressure testing, initial cross-connection testing, purging, and cleanliness cross check activities have been successfully performed. The mere use of an isolating closed valve at the tie in is not acceptable. Connections into existing systems shall utilize cryogenic shape memory taps or NFPA-99 medical gas approved non-contaminating methods.

## 12.5.4 Quality Assurance and Systems Verification

**A. Personnel Certification:** The A/E shall specify that work is performed only by qualified, licensed personnel who are also certified in accordance with ANSI/ASSE series 6000 requirements (specifically ASSE/ANSI 6010 and 6015) including use of only certified medical gas installers and medical gas brazing procedures or approved equivalent ultra-high purity (UHP) or USP oxygen-system installation procedures. Verifiers shall be certified per ANSI/ASSE series 6030 or approved equivalent (e.g., UHP gas test agencies). Submittal of credentials shall be required, reviewed, and maintained in record documents. Each individual installer must be qualified.

**B. Inspection/Testing:** Installations shall be inspected and tested in accordance with requirements for NFPA-99 Category 1, ISO 7396-1, or ISO 7396-2 as modified by this section of the *DRM*.

**C. Third-Party Inspection:** All installations shall be inspected during construction and prior to use by an independent party qualified in medical gas system inspection. Persons certified as medical gas inspectors or verifiers per ANSI/ASSE series 6000 (e.g., but not limited to ANSI/ASSE 6030 medical gas system verifier or ANSI/AS 6020 medical gas system inspector) or other responsible, qualified persons.

**D. Third-Party Verification:** All installations shall be third-party verified upon completion of the installation by a qualified, independent verification process. Each system requires verification of system materials, cleanliness, absence of cross-connections, service continuity configuration review, proper installation, and adjustment and operation of required components following NFPA-99 or ISO 7396 procedures, except as modified per this section of the *DRM*. Delivered gas purity testing (e.g., source gas connected) is required for each system prior to use. Veterinary CO<sub>2</sub> installations shall be verified for contamination (prior to charging with CO<sub>2</sub> by using clean N<sub>2</sub> or argon). ISO 8573 2010 methods of cleanliness testing may be utilized (Class 2 or Class 3) or calibrated on-site analytical methods, and are required where particulate or hydrocarbon contamination of pressurized VMGS is suspected. Purging of dirty systems to achieve a passing state shall not be approved without subsequent comprehensive contamination

analysis (e.g., particle size and count) that is not reliant on preliminary cycle purging.

***Rationale:** The verification process is required to ensure the installed system meets requirements to protect animals and research. The process differs somewhat from verification for hospitals (due to system differences) and is not intended to mandate placement of additional alarms, valving or components. Systems installed dirty may purge clean to pass initial tests only to have recurrent contamination issues.*

## 12.5.5 VMGS System-Specific Additional Requirements

### 12.5.5.1 Veterinary Oxygen

**A. Pressure, Capacity, and Sizing:** The veterinary oxygen system shall provide a pressure of 345–379 kPa (50–55 psig) at all outlets at peak design flow. The distribution system design pressure drop system shall not exceed 21 kPa (3 psig).

**B. Source/Reserve:** System source and emergency reserve shall be high-pressure gas (HPG) cylinders.

**C. Materials:** Gas manifolds and applicable system components (regulators, filters, etc.) shall be designed and listed for auto-ignition resistance per ISO 10524-2 when applied for oxygen systems. Only copper, copper alloys, and nickel copper shall be used. Halogenated elastomers including Viton and PTFE shall not be used in applications over 3000 kPa (435 psig), including manifold components.

**D. Secondary Reserve:** Where supplied from a bulk cryogenic tank or other liquid source, a secondary HPG oxygen reserve shall be provided with at least a 5 day demand at the bulk tank. In addition, an in-building emergency reserve with at least a 1 day demand capacity and appropriate emergency valving/backflow protection shall be provided to ensure that a break or disruption in the underground main oxygen supply piping or bulk tank supply malfunction does not result in disruption of oxygen to the facility. Refer to [Section 12.3](#)

[Compressed Gas and Cryogenic Systems](#) for criteria related to bulk cryogenic systems and additional supply-source requirements.

**E. Emergency Shut-Off:** A source gas emergency shut-off valve with alarm pressure switch, transducer, or tamper switch shall be provided. Refer to [Section 12.3 Compressed Gas and Cryogenic Systems](#).

**F. Maximum Velocity:** Velocities within the oxygen system shall in no case exceed 4,000 fpm, or for cases where stainless steel piping is allowed, shall not exceed 1,800 fpm.

**G. Stainless Steel Piping:** The use of stainless steel piping systems for distribution of gaseous oxygen shall require a design variance with justification, including outline for control of materials, calculations and procedures to prevent future overloading and particle impingement and associated combustion hazards.

***Rationale:** Velocity limitations below 20.3 m/s (4,000 fpm) minimize noise and shock issues while providing a margin below the maximum 30.5 m/s (6,000 fpm) required in consideration of potential particle impingement or design hazards.*

**H. Particles and Contaminants:** Particle count per ISO 8573-1 2010 shall be Class 2 (preferred, except that there is no criteria for particles 0.5 micron and smaller, and count values of up to 500 are acceptable for 1 to 5 micron size class) or may be Class 3. ISO particle cleanliness test methods should be used except that NFPA-99 Category 1 medical gas methods may be used only where systems are sufficiently clean that cycle purging is not required to pass tests. In no case shall particles in distributed oxygen exceed 0.5 mg/m<sup>3</sup>. Test failures shall necessitate passing ISO 8573-1 2010 methods. Limitations for other contaminants shall be per NFPA-99 for Category 1 medical gas.

**I. Grounding:** Oxygen piping shall be electrically bonded to a grounding electrode in accordance with NFPA-70.

### 12.5.5.2 Veterinary Medical Air

**A. Application:** A separate NFPA-99 Category 1 or ISO 7396-1 compliant compressed veterinary air system

shall be provided to serve VMGS needs for animals. Medical air shall not be sourced from the central plant.

**B. Particles and Contaminants:** Particle count and test method shall be as described for oxygen above. Limitations for other contaminants shall be per NFPA-99 for Category 1 medical gas. Other contaminant classes shall be per NFPA-99.

**C. Compressors:** Where compressors are utilized as the supply source, they shall be certified 100% oil-free. NFPA-99 compliant scroll, rotary screw/rotary tooth, or oil free reciprocating compressors.

*Rationale: Liquid ring and oil-lubricated compressors are not acceptable due to potential risks to air quality.*

**D. Dryers/Filters:** Only desiccant-type dryers shall be utilized and the system shall be fitted with a duplex purification package consisting of pre-filter and final filter, capable of effectively removing particulates 0.01 micron and larger. The components shall be designed for application with medical grade air systems.

**E. Pressure Dewpoint:** The system dryer shall provide -40°C/-40°F pressure dewpoint to inhibit microbial growth.

**F. Air Intake:** System source shall be direct from a filtered clean outside location determined suitable for operating-room air intake (or air already filtered for use in operating-room ventilation systems). Systems shall have continuous dewpoint monitors, carbon monoxide monitors, redundant compressors, desiccant dryers, controls, purification trains, and storage receivers. Air intake shall be constructed of corrosion-resistant metallic material, e.g., stainless steel or copper.

*Rationale: Plastic materials are not permitted due to potential corrosion particles, fumes, and toxins that could compromise the system.*

**G. Gas Supply Manifolds:** Fully automatic switchover medical gas manifolds may be utilized in lieu of compressors where demand is low and the use of central production equipment is impractical or not cost-effective.

**H. Use Prohibition:** Veterinary medical air shall not be used for venturi-driven anesthetic scavenging or other non-respiratory applications.

**I. Pressure, Capacity, and Sizing:** The veterinary compressed air system shall provide a pressure of 345 kPa–379 kPa (50–55 psig) at all outlets at peak design flow. Distribution system design pressure drop shall not exceed 21 kPa (3 psig).

**J. Air Quality to Equipment Service Areas:** Veterinary compressed air shall be provided for areas where veterinary medical equipment is serviced (e.g., veterinary biomedical equipment rooms). Local cylinders should be used.

### 12.5.5.3 Specialty Gases

**A. Codes and Standards:** Specialty gases and specialty gas mixtures for VMGS purposes (e.g., nitrous oxide, oxygen/helium, and CO<sub>2</sub> for insufflation) shall be provided as per oxygen systems described in this section and as specifically required according to the program and referenced standards.

**B. Rodent Euthanasia:** The use of inhaled anesthesia gases (typically from local vaporizers) or in some cases CO<sub>2</sub> may be utilized where required by the program veterinarian. Where CO<sub>2</sub> is selected by the program veterinarian, the CO<sub>2</sub> source and distribution system for rodent euthanasia shall be strictly controlled for gas quality, purity, and rate of flow to comply with the ILAR Guide and AVMA guidelines for humane euthanasia. The preferred source is a local (ARF dedicated) NFPA-99 supply manifold, however bulk (central system cryogenic) CO<sub>2</sub> of at least 99.9% purity grade may be used where such a system is provided for the facility and with approval of the program veterinarian. The CO<sub>2</sub> supply shall be in accordance with [Section 12.3 Compressed Gas and Cryogenic Systems](#), including provision of adsorption and particulate filtration to maintain system cleanliness from oil aerosol, hydrocarbon and other gaseous contaminants, line pressure, automatic gas supply status and line pressure monitoring. Two-stage regulation is required for control of pressure (or an arrangement consisting of at least two regulators between the high pressure source and the flow restrictor). An accurate direct reading flow meter, manufacturer calibrated for the specific gas is required at every point of use, and must be visible by the operator. Comply as follows:



1. A local high accuracy pressure lockable regulator, with gauge shall be provided and properly adjusted to serve each dispense point and shall be locked to prevent tampering.
2. Flow shall be accurately controlled such that flow rate to individual housing or euthanasia chamber does not vary from permissible flow rates, as per current AVMA requirements.
  - a. **Recommended Approach:** A pre-calibrated, non-adjustable flow orifice/flow control valve shall be provided in-line, after the regulator. Either a manufactured variable area flow meter with built-in engineered flow control (no adjustment), a suitable mass flow meter, or an engineered non-adjustable flow restrictor (e.g., stainless steel porous metal flow control) or microprocessor arrangement may be used for this purpose. The flow control shall be selected to ensure the flow rate is stable and does not exceed the maximum permitted values, with appropriate allowances for the accuracy of the specified flow meter, orifice, and pressure regulator. A ¼-turn turret, with threaded outlet may be used to receive user attachments e.g., diameter index safety system (DISS) adapters and hoses.
  - b. **Manual Approach:** CO<sub>2</sub> (or other veterinarian specified gas in conformance with PHS policy) may be piped in-line to the point of use, with a flow meter directly visible at the point of use, downstream of the flow control valve. For this purpose, turrets shall be needle-type (not ¼ turn), with threaded outlet to receive the flow meter and required adapters.
  - c. A manufactured assembly engineered for humane euthanasia with precise flow control to each chamber/cage and flow monitoring may be provided.
3. Uncontrolled flow rate shall not be permitted to pass to chamber or cage in excess of permitted flow rates. Where multiple chambers/housings are commonly controlled, the arrangement shall ensure flow control to each unit is within the permissible flow rates.

***Rationale:** Precise control of CO<sub>2</sub> within the accepted range for the chamber or housing unit size is necessary for regulatory compliance and humane use. Automatic flow control which minimizes the need for precise adjustment by users is helpful and minimizes potential of maladjustment.*

**C. Source Location and Gas Conditioning:** Gases shall be located in accordance with required environmental conditions to ensure proper operation. Manifold heaters are typically required for CO<sub>2</sub> and N<sub>2</sub>O at higher flows (e.g., flow above 35 SCFH) and shall be provided as necessary. Adsorbent and particulate filtration is required for CO<sub>2</sub>.

#### 12.5.5.4 Veterinary Surgical Vacuum Systems

**A. Codes and Standards:** Veterinary surgical vacuum systems shall be provided in conformance with NFPA-99 Category 1 or ISO 7396, subject to the clarifications and modifications of this section of the *DRM*.

**B. Application:** The vacuum system shall be provided only for veterinary medical applications and shall not serve laboratory applications whether or not located within the ARF program areas.

**C. Source Equipment Type:** The VMGS vacuum pumps shall be liquid ring type (partial recirculating), water-sealed, suitable for influent liquid slugs, potential chemical vapors, varied halogenated anesthetics, nitrous oxide, and handling of a heavily oxygen-enriched fluid stream. Configurations shall be NFPA-99 compliant, including control/electrical system redundancies, and in accordance with the requirements of [Section 12.4 Laboratory Vacuum Systems](#), except as modified by this section.

**D. Filtration:** The VMGS vacuum equipment shall be protected from contamination with an N + 1 (in parallel) configuration of filters and liquid separators installed on the main vacuum line in the mechanical room, just upstream of the vacuum source equipment. Where a common receiver serves as the liquid separator, redundancy of the receiver is not required. Each liquid separator (or receiver) shall incorporate valves for isolation, valved ports for decontamination, and a sight glass or other means of monitoring liquid accumulation. The

receiver or liquid separators shall be placed upstream of the filters to protect filters from blockage. Each filter shall be provided with isolation valves and valved and capped decontamination ports. Each liquid separator shall be sized adequately to ensure service is not required at intervals more frequently than annually. Filters shall provide not less than 5 log reduction at 0.3 micron in gas streams, shall be 100% integrity tested, utilize a fluoropolymer or stainless steel element and shall be designed for a service life of not less than 6 months, with stainless steel or aluminum housing and shall provide design capacity at not to exceed 0.5 inch Hg pressure drop. A vacuum level sensor shall be provided at inlet and outlet or a differential pressure sensor across the filter to alert BAS for a low system vacuum or pressure loss greater than 76 mm (3 in) Hg. The use of decontamination ports with appropriate isolation valves to facilitate gaseous or liquid decontamination may be considered in lieu of filtration on a project-specific basis as approved by NIH.

***Rationale:** Veterinary surgical vacuum systems are utilized similar to human medical vacuum systems, inclusive of a point of use suction bottle that typically includes a hydrophobic filter or other stop. Overflow or other failures that could result in potential microbial contamination and ingestion of liquids can occur, so protection for the equipment is a beneficial safety precaution.*

**E. Biohazard Sign:** A biohazard warning symbol or other DOHS approved sign shall be provided at each surgical vacuum pump and associated receiver. Where the system utilizes a vacuum system filter arrangement, the signage shall be applied at the filter.

***Rationale:** This is to alert maintenance personnel to the need for appropriate PPE and service precautions. It is not indicative of presence of any particular hazardous agent.*

**F. System Pressure:** System operating pressure shall be for surgical applications, with a low alarm at 12 in. Hg (gauge) (455 Torr/mm HgA/40% vacuum). The preferred operating pressure range at terminal inlets (unless otherwise directed by the program) is 15 to 19 in. HgG and vacuum shall not exceed 19 in. HgG (480 mmHg/65% vacuum) at any terminal unless a deeper

vacuum is requested. Systems shall not rely upon a pipeline regulator to provide an appropriate surgical vacuum level.

***Rationale:** 12 in. HgG (455 Torr/mm HgA/40% vacuum) surgical vacuum may be inadequate for some application, though too deep of vacuum can also be problematic for some applications and requires excessive reliance on vacuum regulators.*

**G. Maximum Design Pressure Loss:** Pressure loss in the distribution system shall be limited to 3 in. Hg at peak design flow.

**H. Branch Lines/Run-outs:** Branch lines and/or run-outs to vacuum inlets shall be taken from the top or 45 degrees above the centerline of horizontal mains to protect from liquid seepage.

**I. System Configuration:** System configurations shall not pipe biohazardous fluids, blood, tissue, etc., from a suction outlet to a remote collection jar or vessel. The suction bottle and filter shall be located at a slide placed adjacent to each surgical vacuum outlet.

### 12.5.5.5 Veterinary Anesthetic Gas Scavenging Systems

**A. General:** A dedicated piped active-type anesthetic gas scavenging system (AGSS) shall be provided for the capture of waste anesthetic gases for all new as well as all major ARF installations where halogenated inhaled anesthetics are routinely applied and wherever nitrous oxide outlets are provided. An AGSS shall also be provided for small programs that do not conduct gaseous anesthetizing procedures in an approved, non-recirculated ducted capture device or utilize a passive neutralizing arrangement that has been determined acceptable by DOHS; and is generally recommended in lieu of carbon/charcoal adsorption arrangements. Scavenging provisions for waste anesthetic during recovery phases must be considered for applications with large animals.

***Exception:** Dedicated anesthetic scavenging provisions are not required where all inhaled anesthesia/analgesia procedures are performed inside ducted and fully exhausted containment devices. Reliance on ducted room air change rates and other passive arrangements are not acceptable. Omission of active piped AGSS in*



any facility performing routine inhaled anesthesia/analgesia shall occur only after a risk assessment has been performed based on discussion with users and the veterinary anesthesiologist and approval of ORF and DOHS. Passive adsorption systems (e.g., charcoal/carbon canisters) are not acceptable for new construction or large program areas.

**Rationale:** The requirement for piped active scavenging is to ensure control of waste anesthetic gas and to address cases where procedures are permitted at a lab bench, on a table, or in another open-room environment. The terminal outlet system provides flexibility for varied procedures and types of anesthetic, animal size, and anesthetizing techniques. Although halogenated volatile anesthetics can sometimes be handled through activated charcoal/portable adsorption systems, reliance upon such systems can be labor intensive and may not perform as intended. Nitrous oxide is not effectively neutralized through activated charcoal systems and users may not be familiar with the limitations and maintenance required. Completely passive systems (e.g., disposal systems that are passive downstream of the disposal side of the airbrake/scavenging interface) are not reliably effective. Effectiveness of charcoal units depends upon proper selection of the adsorption material, suitable placement of the unit or canisters with regards to escaped agent from exhaust ports, frequent replacements and monitoring, and can be subject to saturation and limitations associated with flow rates.

#### 12.5.5.5.1 **Veterinary Anesthetic Gas Scavenging System-Common Requirements**

**A. System Type, Codes and Standards:** Veterinary AGSSs shall be active type and piped systems shall be designed in accordance with this section and NFPA-99 waste anesthetic gas disposal (WAGD) or ISO 7396-2, including provisions for at least N + 1 redundant equipment and associated electrical arrangements.

**B. Source Equipment:** System source shall be side-channel (regenerative) blower type (for low vacuum active systems) or partial recovery water sealed liquid ring vacuum pumps (for high vacuum active systems). Venturi-driven autonomous terminal units may be used for small facilities

or limited applications. System source equipment and all components and elastomers throughout the system shall be suitable for handling various halogenated anesthetic gases, nitrous oxide, and a heavily oxygen-enriched (up to 50%) fluid stream. Low vacuum active type systems are preferred for new facilities.

**Rationale:** These requirements are to ensure required performance, long-term durability, compatibility with a wide range of anesthetics and chemical vapors; prevent need for special oils, to minimize risk of pump fires or other self-ignition damage associated with high oxygen-enriched operating conditions; facilitate operation at low levels of vacuum; and maintain low exhaust-vapor temperatures necessary for safe operation. Regenerative blower based (low-vacuum active) systems are preferred for water conservation, safety, flexibility, and efficacy of the high flow, low pressure system configuration with varied anesthesia techniques and ARF equipment.

**C. Dedicated Systems:** Veterinary AGSSs shall not be combined with other piped vacuum systems for new facilities or major renovations. For existing facilities, veterinary anesthetic scavenging may only be combined with dedicated veterinary surgical vacuum, but only where liquid ring systems are used, and the connection between systems is made at the source equipment location on the distribution system (terminal unit) side of the vacuum alarm sensor serving the plant, but prior to any upstream (distribution system side) main line shut-off valves. Such arrangements shall only be used for high vacuum active designs.

**Rationale:** Due to the criticality of these systems, required alert arrangements, risk to subject safety associated with high vacuum levels and ingestion of vapors and enriched oxygen streams that may not be compatible with other fluids, AGSS are not combined with other vacuum systems. Where shared systems are permitted, the requirement for connection at the source main is to ensure continuous availability of the scavenging system. Venturi-driven terminal units, local blower systems and alternative scavenging configurations can be used in small renovations where provision of a new, dedicated central system is not feasible.

**D. Air Break/Anesthetic Scavenging Interface:** Space and arrangements for mounting at least one open type scavenging interface (commonly referred to as a “veterinary WAG air break” or “veterinary scavenging air brake”) shall be provided within 3 m (10 ft.) of the breathing circuit and shall be within 3 m (10 ft.) of each scavenging terminal unit (typically next to the terminal unit). Air breaks shall be mounted only in an upright position. The quantity and location of air breaks shall additionally be approved by the veterinary anesthesiologist.

***Rationale:** Use of systems without a suitable air break can injure the subject. Systems are designed for use with open air breaks for maximum safety and efficacy. Too much separation from the terminal unit or use point can compromise efficacy or risk hose occlusion.*

**E. Central Alarms:** Alarms shall be provided in accordance with the WAGD provisions of NFPA-99 and shall incorporate additional features as required in the DRM. The alarm function for central vacuum producers shall report a separate general alarm (e.g., stand-by blower in use or other operational alert condition) and plant emergency alarm (for critical conditions) with audible and visual alert to the VMGS alarm panel, which shall provide a second alert to the ARF monitoring or critical laboratory systems monitoring (along with alert to the BAS). A plant emergency fault shall address major faults (e.g., system offline, power loss, loss of vacuum, etc.). The arrangement shall ensure that users are immediately alerted when the system is not properly operating.

***Rationale:** Alarms are required to confirm the operation of the scavenging system. Provision of “general” and “plant emergency” faults is acceptable as long as local equipment alerts can provide more specific fault data.*

**F. Alarm Sensors:** Alarms and sensors shall be coordinated for proper operation, sensitivity, and accuracy and to preclude false tripping. Sensors shall include appropriate delay features and units of measurement as required consistent with system operating range and required set points. Alarms and sensors should monitor in mbar or mm Hg to avoid false alarms.

**G. Terminal Unit/Inlets Flow:** The system shall provide 1.75–3.0 scfm (50–80 lpm) per inlet. Diversity shall be applied only for non-surgical areas where justified through consultation with the program staff, but shall in no case be less than one inlet of 1.75–3.0 scfm (50–80 lpm) (without diversity) for every room where inlets are provided and for every use point that could be in simultaneous use. Alternate designs require justification and approval.

***Rationale:** Multiple terminal units (inlets) are often provided for convenience even for the same procedure area and may be in simultaneous use. The ISO 7396-2 Type 1H flow rate values stated here for each terminal unit are the extraction flow rates to be applied for the disposal system (not the induction scavenging flow which shall be independently established by the veterinarian). These are required to ensure compatibility with common air break designs and effective scavenging under various applications.*

**H. AGSS Emergency Power:** ARF AGSS and associated alarm system shall be served with building emergency power as per NFPA-99 Category 1 system requirements.

***Rationale:** Anesthetic scavenging is an occupant safety system.*

**I. Equipment Drains:** AGSS equipment drains shall be configured as indirect waste. The receiver shall have a manual (normally closed) drain.

**J. Distribution Material:** AGSSs shall be constructed of brazed copper tubing. Nitrogen purge is generally recommended. The use of tubing clean for oxygen service is recommended.

***Rationale:** Brazed copper is the preferred material to ensure compatibility with the oxygen-enriched fluid stream, including its auto ignition resistance, corrosion resistance to anesthetics, and impermeability, and minimizes potential of misapplication.*

**K. Filtration and Decontamination Ports:** Refer to terminal units, this section. The use of decontamination ports to permit gaseous decontamination (blower systems) or liquid vapor, or gaseous decontamination (liquid ring) should be provided at the source equipment.

***Rationale:** Capability to decontaminate or protect source equipment is desirable in some applications. As with medical gas scavenging (WAGD), filtration is not routinely applied at source equipment. The use of disposable filters at terminal units (typically by the user at the air break/interface inlet), combined with provision of decontamination ports at source equipment is considered a best practice. The use of decontamination ports to accommodate a suitable gaseous agent (e.g., chlorine dioxide etc.) can address issues where compatible source equipment is selected.*

#### 12.5.5.5.2 **Veterinary AGSS Type-Specific Requirements**

**A. Low Vacuum Active Systems:** Low vacuum active systems shall comply with ISO 7396-2, NFPA-99, and the provisions of this section and shall be used with open style anesthesia scavenging interfaces/air breaks.

**B. Outlets:** System terminal outlets (terminal units) shall, at a minimum be ISO 7396-2, type 1 high flow, and shall include adjustable balancing features (that shall be set and require tools to modify) to accommodate the high flow rates at the reduced vacuum levels of these systems.

**C. Design Operating Pressure:** Systems shall operate at between 125–180 mbar (50–72 in. w.g.) (94–135 mmHg) below atmospheric pressure as required to comply with ISO 7396-2 type 1-H flow at fixed pressure drop criteria at terminal units. Maximum blower vacuum (per fan curve) shall not exceed 200 mbar (80 in. w.g.) below atmospheric pressure.

**D. Blowers:** Blowers shall be oil-free continuous-run type (the online blower shall run continuously in normal operation). Individual variable frequency drive for each blower shall be considered for units 5 HP and larger. Units shall automatically lead/lag/alternate.

***Rationale:** Continuous run units provide constant available scavenging without extensive ramp-up time, and prevent inadvertent shutdown that would not be obvious to personnel performing procedures unless local control panels were provided within each anesthetizing location. VFD for larger units accounts for operating efficiency for systems that may not be in constant use.*

**E. Check Valves and Regulators:** Check valves shall be selected to ensure tight sealing and suitable cracking pressures for operation with low vacuum regenerative blowers, and shall be selected for the specific orientation (horizontal vs. vertical) and operating pressure. High quality regulators that maintain settings and are not susceptible to tampering once set shall be used.

**F. At-Plant Vacuum Pressure Monitor:** A vacuum sensor shall be provided at the AGSS plant to display vacuum level and alert the VMGS alarm of a plant emergency fault for low vacuum (below 120mbar/90 mmHg) or high vacuum level condition (above 200mbar/150 mmHg). The sensor shall be located on the system side (terminal unit side) of the plant vacuum breaker/regulator to effectively monitor actual system conditions, similar to an NFPA-99 source equipment master alarm signal.

**G. Vacuum Regulation and Relief:** A vacuum relief/vacuum breaker shall be provided at the plant to limit vacuum in the system from exceeding 200 mbar (typical relief set point is approximately 175 mbar). Air intakes serving loaded plate-type vacuum breakers/regulators shall be equipped with an appropriate particulate filter (typically 10 micron) and the regulator/intake shall be placed in a clean, dry, secure area not subject to tampering and accessible for service. Once adjusted, the set point shall be recorded and labeled. Factory calibrated pre-set regulators may be used where coordinated with system balance requirements.

**H. Power and Controls:** Controls/electrical configuration shall be of a redundant NFPA-99 configuration, and system arranged such that individual blowers may be serviced or replaced without disrupting system operation. There shall be PLC control with continuous run of one blower and automatic lead/lag/alternation to

maintain system vacuum. All control panels shall be appropriately listed.

**I. Exhaust Backpressure:** Exhaust shall be designed to prevent unacceptable backpressures and shall incorporate either a valved drain flask or sufficient drip pocket with drain valve.

**J. Fault Alarms:** Emergency plant fault, reserve blower in use (or whenever all blowers are in operation), and general plant fault signals shall report (independently) to the facility VMGS alarm panel of the area served in addition to individual alerts at the local (source equipment) control panel. Shut-off or failure of any one pump or positioning of either or both pumps in manual mode shall initiate a plant alarm fault. A vacuum-level drop below 120 mbar as sensed at the plant or shut-off of system shall initiate an emergency plant fault. A vacuum level above 200 mbar as sensed at the plant shall activate an emergency plant fault. Faults shall activate regardless of position of HOA switches.

**K. Remote Vacuum Pressure Monitor:** In addition to these equipment (plant) faults, the normal operating pressure of the scavenging system shall be monitored by pressure sensors capable of accurate operation at system vacuum levels, located at the remote end of the pipe line in each major animal corridor served. The sensors shall indicate and alarm to the VMGS alarm panel at 20% above and below normal system operating pressure. Monitoring of individual mains shall alert to the appropriate area alarm function of the VMGS alarm panel, or to an area alarm configured with master alarm style indicators for high and low faults, provided an operational pressure display is also provided.

**L. Local System Alternate:** For small facilities with only a few locations requiring periodic AGSS, the provision of an ISO 7396-2 type 1H system with remote control panels at the use point may be utilized in lieu of a central automatic system configuration, provided the system meets all redundancy requirements and the alarm conditions are replicated to the VMGS alarm panel, the system location is at an approved, secure location and in consideration of noise and exhaust requirements. The system shall comply with requirements of this section.

***Rationale:** This is to allow for use of local systems with remote start-stop panels that can be monitored at the point of use, for limited applications where this may be acceptable and costeffective. Central systems are generally required in lieu of multiple small systems to conserve space, noise, and maintenance.*

**M. Terminal Unit Probes:** Each terminal unit shall be provided with a standard angle or straight probe (e.g., outlet adapter) compatible with the terminal unit to facilitate the hose connection. At least one probe per terminal unit is required and shall be turned over to the facility through the PO after system verification.

***Rationale:** The probes are required for initial verification and validation of the system and its subsequent use.*

**N. Distribution System Sizing:** Systems shall be sized to achieve operation once terminal units have been adjusted as per ISO 7396-2. Velocities in mains shall not exceed 9.14 m/s (1,800 fpm) and individual connections shall not exceed 5.59 m/s (1,100 fpm).

**O. System Testing, Balancing, and Verification:** The testing, and verification process of systems with terminal units operating in the low vacuum active range shall include all steps and methods as indicated in ISO 7396-2 with the verification/certification component performed by the qualified verifier. Completed systems shall be properly balanced in accordance with ISO 7396-2 prior to use. At minimum, balancing and verification shall be performed under flow conditions of only the single unit nearest the source, only the single unit most remote, and random units throughout the facility up to the design demand of the system flowing, after verification and adjustment of each terminal unit. The system must be confirmed to provide proper operation within ISO 7396-2 type 1H criteria for the design quantity/locations of outlets in simultaneous operation and the A/E shall indicate this quantity in the Basis of Design. After setting, all orifice lock screws/grub screws etc. shall be verified to be locked to prevent loss of adjustment. The proper operation of each required alarm signal shall be verified, and shall include confirmation of alarm sensitivity and avoidance of false tripping. The verification



process shall ensure proper operation of each terminal unit through any potential sequence of outlets in simultaneous use, up to the design demand.

**P. High Vacuum Scavenging Alternative:** Independent high vacuum active systems, at not to exceed 12–15 inHg, may be utilized subject to compatibility with the intended applications, anesthesia interface style, and flow rates. Wherever such high vacuum scavenging is utilized, it must be confirmed that the approach is acceptable to the program veterinary anesthesiologist. Such systems shall utilize conventional NFPA-99 WAGD high vacuum DISS outlets and may utilize air breaks (open interfaces, highly recommended) or closed interfaces designed for such use. Planning to accommodate open interfaces is required.

***Rationale:** High vacuum WAGD is not preferred due to lower flow rates at outlets, the reliance on mechanical point of use safeties associated with closed interfaces to achieve significant (e.g., greater than 500x) turn-down ratios and maintain stability, and sensitivities of small animals. The use of a suitable high vacuum compatible open interface (air break) is recommended if high vacuum is being used, but must be selected for such vacuum levels to ensure safe and effective use.*

**Q. Alarm and Verification Requirements:** Alarm features and set points shall be provided as per low vacuum active systems. Where high vacuum systems are utilized and operated at those levels, the alarm points of the high vacuum distribution shall be per NFPA-99 for WAGD systems. Verification of high vacuum active WAGD shall be per NFPA-99.

**R. Venturi-Driven Terminal Units:** In lieu of dedicated piped anesthetic scavenging systems, small systems (typically less than 10 outlets) may use compressed-air-driven active venturi-type anesthetic gas scavenging terminal units per NFPA-99 or ISO 7396-2. Such units shall be autonomous self-contained type and maintain a sealed system, requiring only air supply and a piped exhaust connection. Compliance with the following is required:

1. **Supply Air Source:** Facility high-pressure lab/instrument air or dedicated compressed air manifolds shall be utilized to drive venturi terminal units, provided the arrangement meets required

capacity and pressure and that redundancy and supply source monitoring are provided to not less than would be required for an NFPA-99 Category 1 pressurized medical gas system. If cylinders are used, the high rate of flow associated with operation of the venturi outlets and provision of adequate reserve in case of primary bank failure must be demonstrated, and use of cylinders for such purpose shall require approval of the program veterinarian.

***Rationale:** The quantity limitation on use of active venturi-type inlets is due to the high energy costs/efficiency of producing a vacuum through this method due to the consumption of compressed air, as well as additional maintenance needs for this type of device. However, such application may be acceptable for facilities with very limited demands as it may eliminate entire piping systems, especially where use is infrequent, demands are low, or where a remote need (e.g., in a lab) is required.*

2. **Drive Gas Alarm:** The drive air supply primary and backup status, cylinder bank pressure upstream of the line regulator, and reserve low and line-pressure alarms shall be used to provide a dedicated anesthetic scavenging drive gas alert to the VMGS alarm panel. They shall provide alert to the ARF or laboratory monitoring system (where utilized) or other approved second program-designated alert point, along with the alert to the BAS or ARF area monitoring system, as approved by NIH to provide at least two areas of responsibly monitored alarm supervision.
3. **Drive Gas Supply and Terminal Unit Exhaust:** Venturi-driven systems shall be provided with instrument grade (or better) compressed air at required pressure to drive each terminal unit per manufacturer's requirements and shall exhaust indirectly to a continuous, non-recirculating building fume hood exhaust system in accordance with NFPA-99 or ISO 7396-2 or as approved to the outside. The arrangement shall be coordinated with the HVAC systems design. Only individual piping from each terminal unit to the exhaust point is permitted (venturi-driven

outlets may not share a combined exhaust pipe upstream of the connection to the exhaust location in any manner that back-pressure or flow reversal could occur). Proper capture of waste anesthetic at the exhaust shall be confirmed.

4. **System Type and Capacity:** System terminal units shall be ISO 7396-2 active venturi type, designed to provide adequate flow rate in accordance with system drive gas supply air pressure. Terminal units shall provide at least 50 LPM flow in accordance with the referenced standard. System design shall be in accordance with ISO 7396-2 and NFPA-99.
5. **Visual Indicator:** Terminal units shall include a visual indicator to clearly alert users that the unit is properly operating (suction is present) and to indicate loss of suction.

## 12.5.6 VMGS Outlets and Terminal Unit Location, Quantity, and Placement

**A. Minimum Quantity and Locations:** The gases as listed in [Table 12.5.6 Animal Research Facility Gas Terminals for Animal Procedures](#) are required for each function area listed, unless waived and are to ensure flexibility for ARF programs. They may not include all required outlets/terminal unit quantities or address all spaces. The A/E shall verify locations and quantities for additional outlets with program requirements. Additional outlets are often required for programmatic flexibility and to facilitate work with multiple animals (sometimes simultaneously) as compared to conventional hospital application arrangement and often require multiple outlets within the same room for flexibility, especially in the case of vacuum, O<sub>2</sub>, and anesthetic scavenging.

**B. Outlet/Terminal Unit Placement:** Outlets/terminal units shall be placed near to the required point of use to minimize excess hose lengths. They shall be provided only at accessible locations where not subject to damage or likely collection of liquids, dirt, or debris. Floor-mounted outlets are not acceptable. For surgical areas or other spaces where overhead services are required

away from walls, the use of ceiling columns or replaceable gas pendant hoses (e.g., from DISS outlets) or medical gas pendants shall be provided.

**C. Outlet Type:** Outlet types shall be bold color-coded faceplate DISS type or other bold color-coded type that is individually keyed to the gas application and approved by the program user group and compliant with this section. Where human patients are served in the same facility, the type of ARF gas outlets and systems identification shall be distinctly different from the type used for human medical applications (e.g., DISS versus quick connect indexed medical gas). Conventional lab turrets are not acceptable. For outlet requirements for waste anesthetic scavenging systems, refer to [Section 12.5.5.5 Veterinary Anesthetic Gas Scavenging Systems](#).

***Rationale:** The use of DISS outlets provides a standardized rigid outlet type than can be adapted to a variety of services, withstand mounting of regulators and controls and provide both bold visual and physical protection from accidental cross-connection to the wrong gas. Lab turrets are not fail-safe indexed or automatic valved, and do not comply with required standards.*

**D. Outlet Materials of Construction:** Outlets/terminal units shall be of noncorrosive construction. The use of stainless steel, plastic, and copper/bronze materials shall generally be provided.

**E. Ceiling-Based Services and Pre-manufactured Outlet Stations:** The A/E shall coordinate surgical columns or other ceiling services to ensure required outlet/terminal unit location, need for redundant/spare outlet positions, and associated column service quantities e.g., electrical receptacle quantity, ground jacks, hooks for intravenous fluids, etc. A mock-up and approval of column placement shall be provided prior to installation.

**F. Multi-outlet Columns and Terminal Constructs:** Multiple-service outlets shall not be manifolded to single-piping connections unless sized for the simultaneous load, including but not limited to pre-manufactured applications e.g., ceiling columns and other pre-finished terminal stations. For veterinary anesthetic gas scavenging, individual ¾ in. (20 mm) service-line connections are required where multiple terminal units are provided.



**G. Ignition Sources:** Oxygen service and anesthetic scavenging gas outlets/terminal units shall not be placed next to electrical receptacles or other spark sources, including at manufactured ceiling columns or other pre-manufactured assemblies.

**H. Provision of AGS Terminal Units:** Anesthetic gas scavenging terminal units should generally be placed at

gaseous anesthetizing locations, and shall be provided alongside nitrous oxide wherever provided.

**I. Slide Brackets and Air Break Brackets:** A slide bracket shall be provided to serve each veterinary medical (surgical) vacuum inlet and shall be placed adjacent to the vacuum inlet, but spaced a few inches (a blank outlet space) from the adjacent terminals to allow space for the medical vacuum suction canister.

**Table 12.5.6 Animal Research Facility Gas Terminals for Animal Procedures**

Functional Area	Gas
Procedure/Exam/Treatment	Veterinary oxygen and veterinary surgical vacuum <sup>a</sup> are typically required. Veterinary anesthetic gas scavenging is often required. Carbon dioxide (rodent areas only) and veterinary medical air <b>may</b> be required. Consult the program requirements.
Necropsy	Carbon dioxide (rodent only) and compressed (lab) air (typically high pressure lab air), are required. Oxygen and veterinary surgical vacuum may be required. Consult the program requirements.
Preoperative Prep Room	Veterinary oxygen, veterinary anesthetic gas scavenging, and veterinary surgical vacuum <sup>a</sup> are typically required. Veterinary medical air and veterinary anesthetic scavenging may be required. Consult the program requirements.
Surgery	Veterinary oxygen, veterinary surgical vacuum, <sup>a</sup> and veterinary anesthetic gas scavenging are typically required. In addition, veterinary medical air, veterinary nitrous oxide, and high-pressure nitrogen or high-pressure air may be necessary. Consult the program requirements.
Magnetic Resonance Imaging/Imaging Spaces	Veterinary oxygen, veterinary surgical vacuum, <sup>a</sup> and veterinary anesthetic gas scavenging may be required for veterinary imaging. Consult the program requirements <sup>d</sup>
Intensive Care Unit	Veterinary oxygen and veterinary surgical vacuum <sup>a</sup> are typically required. Veterinary medical air and veterinary anesthetic gas scavenging may be required. Consult the program requirements.
Recovery	Veterinary oxygen and veterinary surgical vacuum <sup>a</sup> are typically required. Veterinary medical air and veterinary anesthetic gas scavenging <b>may</b> be required. Consult the program requirements.

**General and Keyed Notes:**

<sup>a</sup>*Veterinary surgical vacuum is not typically required where only serving small rodents. Consult the program requirements.*

<sup>b</sup>*Anesthetic gas scavenging provisions are typically required in animal surgery areas and procedure rooms and all areas where nitrous oxide is utilized. Other locations may be required and shall be confirmed after consulting the program requirements. Refer to Section 12.5.5.5 Veterinary Anesthetic Gas Scavenging Systems.*

<sup>c</sup>*A vacuum slide bracket (to accommodate a suction bottle) is required adjacent to each surgical vacuum terminal unit, typically spaced approximately 75 mm clear on each side of the bracket to allow for the bottle. Consult the program requirements for any additional slide brackets.*

<sup>d</sup>*Other gases, e.g., compressed air (non-veterinary/non-medical) are typically required for equipment, refer to Section 12.3 Compressed Gas and Cryogenic Systems*

**J. Anesthetic Scavenging System Protection:** Decontamination ports (for gaseous decontamination) may be provided at central equipment where requested. The use of filters shall be provided by the program as point of use items. Where filters are required to be provided elsewhere in the system, the arrangement must be approved by ORF, DOHS, and the program veterinary anesthetist.

***Rationale:** Filters may be required for some applications and best practice includes incorporation of disposable filters at the point of use. Placement must be approved by the program veterinary anesthetist (typically between the breathing circuit and the air break/interface), though in some cases may be determined acceptable to be in the transfer hose at the wall outlet/terminal unit). There are significant limitations to pressure drop and flow through such filters and inappropriate application or maintenance can result in safety hazards.*

## 12.5.7 Barrier and Quarantine Facilities

**A. Services Areas:** Although risks of cross infection through VMGS systems are considered low with proper design, filter use, and operating procedures; connection to central ARF veterinary gas and vacuum systems or systems serving other areas shall be made only upon review and approval of the program veterinarian.

**B. Filters:** The use of replaceable, validated medical gas filters are typically required, and shall be fitted at the point of use as per the Risk Assessment and coordinated with users during planning. Filters shall be appropriate for USP-NF oxygen service.

***Rationale:** Maintaining the intended status of specific-pathogen free and quarantine areas from cross-contamination is critical to the research program. Often clean and dirty transgenic spaces are in close proximity; precautions are necessary to minimize risk of cross-contamination, especially considering that systems might not always be pressurized. The application of point of use disposable medical gas ultrafiltration or sterile filtration are typically required to ensure gas purity at individual outlets serving such areas, and should be confirmed with the program requirements.*

# Section 12.6

## Plumbing Requirements for Specialized Equipment

---

### Contents

12.6.0 Introduction

12.6.1 General Requirements

12.6.2 Hazardous Process Fluid Systems

12.6.3 Remote Bedding Disposal Systems

12.6.4 Detergent Systems/Cage Wash and Similar Applications

## 12.6.0 Introduction

This section addresses the provision of piping services to specialized equipment utilized in support of laboratory and animal research facility (ARF) operations which due to their unique nature, do not directly fit within the scope of other *DRM* sections.

---

## 12.6.1 General Requirements

**A. Standard/Code Compliance:** Compliance of pressure vessels and piping shall comply with the relevant sections of ANSI/ASME, 21 CFR, good manufacturing practices (GMP), and relevant recommendations and standards of ISPE (International Society of Pharmaceutical Engineers).

**B. System Failure/Redundancy:** Each application shall be evaluated for plausible failure conditions that could impact product quality, research, operations, or present safety hazards or contamination threat. Redundancy of components and controls and provisions of auxiliary power shall be taken commensurate with the consequences of single point failure to the specific application.

**C. Process Failure:** Any automated process that includes a high potential of damage or safety risk due to plausible automated or component failure and operating error shall be considered and addressed in design and O&M requirements, including steps to safely mitigate the issue.

**D. Routing/Location:** Process sterile or hazardous fluids shall not be buried, located where not visible for routine inspection, or located, routed, or distrusted in any area where a hazard to quality, purity, or safety may occur. Services shall be located only in controlled areas, consistent with the process application and shall not route to unrelated building areas or containment boundaries except as approved.

**E. Service Line Protection:** Service lines shall be protected from backflow or contamination conditions commensurate with the risk.

**F. Test and Validation Criteria:** Test, validation, and quality assurance criteria shall be proposed by the A/E and submitted for NIH review.

## 12.6.2 Hazardous Process Fluid Systems

**A. Hazardous Process Fluid Systems:** Where any required process fluid system is deemed hazardous to safety or a significant risk to facilities or research, the issue shall be brought to the attention of the program administrators, the DOHS, DFM, and ORF for review (as appropriate) by the A/E through the PO. Application and design of hazardous fluid systems must be approved by the NIH prior to installation, including DOHS, ORF, and DFM.

**B. Design:** Each process system shall be designed by professionals experienced and knowledgeable in their safe and proper design; or as otherwise approved by NIH as qualified subject matter experts.

**C. Risk Assessment:** A risk assessment including a systems safety and operability analysis shall be provided and independently reviewed by a team of subject matter experts and risk management professionals.

1. The analysis shall consider (but not be limited to) general issues associated with the process fluid, occupational exposure limits and monitoring, internal and external contributors, normal and emergency conditions, common operating errors, emergency responses, equipment failures and instrumentation errors, simultaneous and cascading failures, as well as project/site-specific risks, vandalism, and disaster (fires, floods, etc.) The analyses shall demonstrate adequacy of safety relief devices for worst-case relief events and that the disposal location and arrangement is safe and ensures no re-entrainment issues. The analyses shall address significant likely component failures and operating errors, as well as required steps to safely mitigate the issue. The documents shall be included in project O&M manuals.

**D. Inherent Safety:** Systems and processes shall be designed to be inherently safe and to minimize risks to research and facility operations to the extent possible including design to avoid hazards that could induce safety concerns or potential loss of research, rather than reliance upon manual or automated controls.

1. Hazardous chemicals shall be stored in minimum necessary quantities, in the safest manner

and lowest acceptable pressure condition. Maximum quantities shall comply with limitations of NFPA and IFC standards, and as otherwise directed by the DOHS and DFM.

**E. Hazardous Fluid Systems Quality Process:** A quality-control process shall be provided to ensure the appropriate design of all hazardous fluid systems prior to submission for NIH review. An independent quality-control and quality assurance process shall be required for verification of the installation, design, startup, and development of standard operating procedures (SOPs) of any hazardous or toxic system.

**F. Critical Process Condition Measurement:** All critical process conditions (temperature, pressure, concentration, etc.) where deemed critical to safety or integrity shall be measured directly at the point of concern (rather than inferred or at an indirect location where a process variation such as pump status or valve position) could impact value.

**G. Hazardous Services Location:** Hazardous services shall not be concealed or located in a means of egress, near areas of public occupancy, near aquatics or animal areas, in an area without adequate means of emergency egress, or where otherwise inducing an inherent exacerbated risk.

**H. Ventilated Gas Cabinets:** Approved ventilated gas cabinets shall be provided for hazardous gases in accordance with IFC and NFPA requirements or where otherwise directed by DOHS.

**I. Hazardous Services Materials:** Hazardous services shall be provided with welded connections by qualified welders. VCR-type joints may be used at final connections or where otherwise required, code compliant, determined suitable, and approved unless such fitting use is contraindicated. Materials shall be appropriately mechanical impact/damage and fire resistant.

**J. Hazardous Services Pressure/Temperature:** The operating pressure and temperature of hazardous services shall be minimized. Hazardous gas services over 69 kPa (10 psig) shall be provided with excess flow valves. Flow-restrictor orifices shall be provided at compressed gas cylinders to minimize flow. The appropriate safety factors for pressure ratings shall be applied in consideration of each application. Standard pressure

rating safety factors (as used for non-hazardous systems) are unacceptable. The rating shall be determined by the process engineer and in accordance with governing codes and standards.

**K. Safety Failures and System Control:** Designs shall not be subject to run-away reactions or safety failures due to single common operating errors (example opening or closing of wrong valve). Preventive design features shall be provided consistent with the consequences of a failure condition. System fluids, reactions, byproducts, and venting shall be safely controlled at all times. Pressures and temperatures shall be controlled, and venting shall be to a safe location, arranged to preclude obstruction, and with protection from contamination or hazards associated with vent and relief operations.

**L. Safe Separation:** Systems shall maintain safe separations from any incompatible or reactive fluid handling system or component, including under emergency conditions.

**M. Automated Controls/Monitoring Systems:** Although the use of automated controls and monitoring systems is encouraged, hardware and software operation shall not take the place of appropriate safety controls and hardware interlocks. Systems shall maintain a safe operation without inducing a loss of research even under conditions of hardware or software failure.

*Rationale: Automated systems may provide appropriate monitoring and control, but shall not be relied upon as the final line of protection against safety or critical research protection. An undiscovered software error, programming issue, false parameter, or hardware malfunction can still be present.*

**N. Limit Energy Sources:** To the extent possible, energy sources shall be limited to provide inherent protection from potential hazards associated with a control or operational failure. For example, sizing of pumps and associated shut-off pressure shall be below the pressure set point of relief valves and materials ratings such that energy sources are limited to ensure over-fill/over pressure conditions cannot occur.

***Rationale:** By limiting the capacity of the energy source (e.g., maximum output of heaters and maximum capacity of pumps) inherently safe design can be achieved even in the event of a control failure.*

**O. Remote-Operated Emergency Isolation Valves:** Remote-operated emergency isolation valves shall be provided for all critical emergency control valves. Reliance upon manual valves exclusively (which may not be accessible in an emergency) is unacceptable.

**P. System Components Suitability and Quality Control:** Piping, joints, valves, and other materials and seals shall be appropriately selected for the application, fluid, corrosion resistance, worst-case ambient-exposure conditions, location, and with appropriate control of leakage rates, and shall be subject to NIH approval. Permeability, corrosion resistance, absorption, and emergency conditions including but not limited to overpressure, overtemperature, and fire conditions shall be considered. Where subject to exothermic reactions, appropriate consideration shall be applied to ensure compatibility. Rigorous quality control shall be provided for the verification of materials supplied and installed, handling, proper fabrication, and testing. Materials in contact with the fluid shall be sufficiently corrosion resistant, or fitted with approved liners suitable for the application. The use of coatings is unacceptable.

**Q. Static Electricity:** Effects and mitigation of static electricity shall be considered as appropriate to the application and is mandatory for flammable and oxidizing services.

**R. Component Access for Inspection:** All components of systems and distribution shall be visible for routine inspection, including special design at penetrations. Where hazardous or corrosive fluids are involved and this is not possible, double containment with interstitial monitoring shall be required.

**S. Safety Controls:** The presence, proper operation, and correct set points of all safety devices shall be verified. Safety controls and alarm annunciations shall be manually reset only with separate resets for visual and audible indications, and in the case of software, shall be pass-code protected. Alert systems shall monitor to redundant and separate locations, as determined on an application-specific basis.

**T. Disarm/Bypass:** The disarm or bypass of any safety feature shall be independently monitored and shall indicate a warning of the condition until corrected.

**U. Equipment Labeling:** All tanks, components, and equipment shall be clearly, completely, and unambiguously labeled. The use of appropriate yellow background with black lettering shall be provided for all hazardous systems unless otherwise approved. Flow arrows and operating pressure shall also be indicated.

**V. Tank/Component Pressure:** All tanks and components shall be appropriately rated for maximum potential induced vacuum, as well as positive pressure; including under conditions of reaction.

**W. Reagents:** Rate of reagent addition, pressure, temperature, and flow increase as well as the potential for exothermic reactions shall be controlled. The consequences and safety requirements associated with the addition of reagents shall be carefully evaluated by the design professional.

**X. Tank Overfill/Overpressure Protection:** All tanks shall be provided with appropriate overfill and overpressure protection. Where remote fill arrangements are utilized, the fill pump shall not be capable of a fill rate faster than the overfill and overpressure liquid volume relief capability to protect from overpressure.

**Y. Flow Reversals:** Systems shall be designed to safely control hazards associated with flow reversals.

**Z. Pressurized Process Chemicals:** Where potentially hazardous pressurized process chemicals are utilized, appropriate shielding or containment shall be provided at mechanical connections and tubing to protect users and maintenance staff from hazards during service or operation. Only sufficiently durable materials shall be provided, and where subject to exothermic reactions must be adequately protected.

**AA. Diking:** Diking shall be sized adequately for the complete system contents and total vessel volume, including any additional contents that may spill as the result of a reaction and shall be impermeable to the fluid and capable of handling a rapid rate spill. Where a drain-out valve is provided, the valve position shall be locked shut and monitored. Hazardous and reactive materials shall be appropriately segregated. Compatible leak detection shall be provided for all diked areas.



**AB. Fluid/Vessel Containment:** Where containment is necessary for a fluid or vessel, the containment shall be appropriately arranged to protect from overflow or release, and shall consider the entire contents of the connected piping and vessels.

**AC. Fluid/Gas Ambient Detectors:** Appropriate process fluid/gas ambient detectors of required sensitivity shall be provided, calibrated, and verified. Set points shall be verified by risk analysis or codes and standards with acceptance confirmation as directed by the DOHS.

**AD. Documentation:** Comprehensive BOD documentation shall be provided, including an outline of the sequence of operations, recommended O&M data, and documentation for any items or practices critical to system integrity or safety.

**AE. Emergency Power:** Emergency power (life safety where applicable and for all hazardous or toxic gas monitors) shall be provided, along with required fail-safe provisions. Valves and components shall fail in safe positions.

**AF. Safe Maintenance:** Systems shall be designed, located, and arranged to minimize hazards and risk of injury to personnel or property as may be associated with routine maintenance and service activities.

**D. Pipe Cleaning Provisions:** Overhead piping systems shall be arranged to facilitate disassembly for clearing of stoppages, or provided with cleanouts. Such cleanouts must be arranged to seal tight, and shall be specifically detailed so as not to impede flow or contribute to stoppages.

**E. Routing of Piping and Noise Control:** Routing of system distribution lines and equipment placement shall be made with consideration of noise associated with operation.

**F. Restricted Areas:** System routings shall avoid animal holding rooms and other spaces where associated noise and maintenance access may be an issue. Avoid sensitive sanitary spaces or other critical areas such as surgical spaces, barrier areas, high containment, and similar restricted spaces.

**G. Traps:** Traps serving bedding disposal units shall be at least 100 mm (4 in.) diameter. The use of 150 mm (6 in.) trap and use of piping at slopes of 3–4% may be adequate, especially where sufficient water flow for drain line transport is provided. Jetted traps shall be used where necessary to control waste stoppages. Sealed equipment connections are required.

***Rationale:** Malfunction of bedding systems can be highly disruptive to cage wash operations. Failure to provide suitable gas-tight cleanout designs that are free-flowing can result in need for frequent disassembly of piping systems to clear stoppages, and is undesirable even where systems are designed for handling of only dry bedding. Moisture often enters bedding systems and contributes to clogs. Cleanouts that are out of the flow path and pose no flow restriction (e.g., cleanouts that extend as floor cleanout access housings to suitable service areas on the floor above) should be provided. The use of pressure-system-compatible threaded caps or gasketed flanges within access housings are examples of effective approaches; standard drainage system cleanout plugs may be susceptible to leakage. Removable spool pieces and flanged elbows can also be used to facilitate cleanout access in some cases; however, maintenance for such arrangements can be highly disruptive if within program areas.*

### 12.6.3 Remote Bedding Disposal Systems

**A. Equipment Selection:** The A/E shall discuss with the user group and determine if bedding will always be dry or may be wet or slurry; prior to selecting systems.

**B. Failure Assessment and Redundancy:** Systems shall be designed to minimize risk of plausible single point failure. Redundant drive sources (vacuum pumps, motors, etc.) shall be provided to ensure continuous operation and facilitate routine maintenance without disrupting vivaria operations.

**C. Waste Piping Radii:** Piping radii for directional changes must be arranged to minimize potential for stoppages. Direct routing with minimal horizontal to horizontal offsets shall be provided and documented in design drawings.

## 12.6.4 Detergent Systems/ Cage Wash and Similar Applications

**A. Chemicals:** Chemical type shall be as approved by the program user group.

**B. Location/Design:** Location of bulk chemicals and components, and system design parameters shall be in conformance with ASME B31.3, IBC, and NFPA standards, and requirements of the *DRM*.

**C. Containment:** Adequate protection shall be provided for the entire volume of chemical to protect from spillage or sudden rupture, including piping contents, and to protect from exothermic reactions.

**D. Routing:** Pressurized chemical lines shall not route above animal rooms, surgery, or other sensitive spaces unless such piping is double contained and properly protected from mechanical damage.

**E. Design Review:** The process design shall be fully detailed, including any required vents, safety devices, and all materials and components. All designs shall be reviewed and approved by NIH prior to installation.

# Chapter 13

---

## Aseptic Production Facilities

# Section 13.1

## General Aseptic Production Facility Requirements

---

### Contents

13.1.0 Introduction

13.1.1 Statutes, Regulations, Standards, and Guidelines

13.1.2 Coordination Between Statutes, Regulations, Standards, and Guidelines

13.1.3 Definitions

13.1.4 Abbreviations

### 13.1.0 Introduction

Successful Aseptic Production Facilities (APF) projects require continuous and collaborative effort from project initiation to the end of the project facility life cycle. NIH’s APFs produce therapeutic and diagnostic products for human use, inclusive of those required to follow Current Good Manufacturing Practice (cGMP) regulations, and aseptic processing (for those manufacturing biological products), for the production of Phase-I and II clinical trial products (See Figure 13.1.0). These facilities are subject to requirements, which do not directly fit within the scope of other DRM sections. This chapter references sections of the DRM where the criteria are the same as other NIH facilities.

The purpose of this chapter is to establish minimum criteria for NIH APFs which helps ensure that patients receive products of appropriate strength, identity, quality, purity, and other factors related to patient safety; this chapter focuses on those factors that can be directly or indirectly impacted by the facility. This chapter is intended to provide requirements and reinforce strategies to mitigate risks where the facility can have a direct or indirect impact. See Figure 13.1.0 for additional information on how this chapter relates to supporting the overall clinical investigation process.

This risk reduction is accomplished by:

1. Designing and constructing APFs:

- a. To facilitate product safety, cleaning, maintenance, and operations to mitigate potential risks to product, patients, and staff.
  - b. To minimize potential contamination and to limit mix-ups, cross-contamination, and exposure to objectionable chemical and microbiological contaminants.
  - c. To be robust and resilient in order to operate under control, even with partial/complete failure of primary systems.
2. Manufacturing, storing and dispensing human-use drugs, biologics, and related materials, in highly controlled environments.
  3. Following strict documentation, change control, and validation processes throughout the APF life cycle.

Failure to adequately design, build, and operate APFs under-control, can result in the potential contamination of products, threaten patient and worker safety, cause injury, illness, complications, or even death. Failure to maintain control of the facility can result in worker injury, illness, or death. Due to the level of risk inherent in APFs, there are significantly higher requirements for these facilities, compared with typical laboratories (e.g., BSL-2, 2/3, etc.).

Figure 13.1.0 DRM Chapter 13 Application

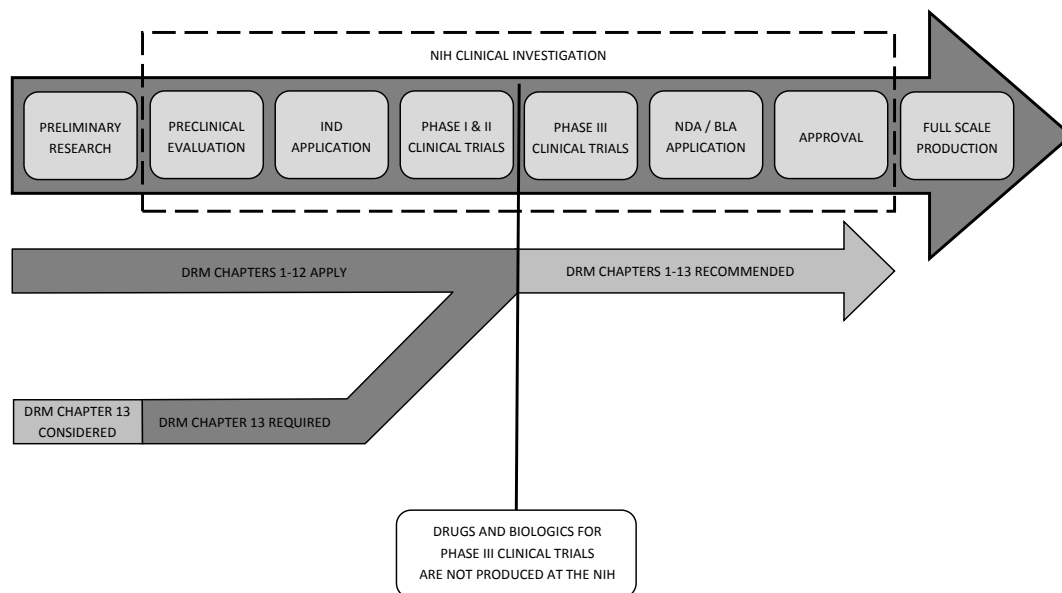

Due to the nature of APFs and their regulation, accommodation for an existing facility cannot be ‘grandfathered’ into a plan to update or replace the facility.

Within cGMP, the good practice guidance and (GxP) regulations are ever evolving. When new practices are promulgated, compliance shall be initiated within a reasonable time, or by a stipulated date (i.e., a “comply by” date is given by the authoring body). APF facilities must be maintained in a current state of compliance, requiring vigilant surveillance of the good practice guidance and GxPs throughout the life cycle of the facility.

Figure 13.1.0 is a diagram indicating that DRM Chapter 13 is intended to be a requirement for facilities producing Phase-I and II clinical trials at NIH; taken into consideration before, and as recommended practice, after.

### 13.1.1 Statutes, Regulations, Standards, and Guidelines

Aseptic Production Facilities are highly regulated environments; applicable statutes, codes, standards, regulations, and guidelines are based upon the product being produced, and the locations the drugs and biologics are administered (e.g., extra-jurisdictional enforcement may be applicable). See Table 13.1.1.

Above and beyond these requirements are Good Engineering Practice (GEP) and cGMP which are, at their core, driven by risk analysis.

At NIH, the primary focus is Phase-I and II clinical trials. The codes, standards, regulations, and guidelines provide the minimum requirements for design,

**Table 13.1.1 Diagram indicating high-level organization of regulations into Pharmaceuticals, Biologics and Medical Device Facilities**

Drugs				
Pharmaceuticals	Biologics			Medical Devices
USP <795> Pharmaceutical Compounding - Nonsterile Preparations	Products not subject to Human Cells, Tissues, and cellular and tissue-based Products (HCT/P) regulations	21 CFR Part 1271, Section 361 - Minimal Manipulation of Human Cells, Tissues, and Cellular Tissue-Based Products	21 CFR Part 1271 Section 351 - More Than Minimal Manipulation of Human Cells, Tissues, and Cellular and Tissue-Based Products	21 CFR Parts 800-1299
USP <797> Pharmaceutical Compounding - Sterile Preparations				
USP <800> Hazardous Drugs - Handling in Healthcare Settings				
USP <823> Positron Emission Tomography - Compounding				
21 CFR 353a - Pharmacy Compounding				
21 CFR 353b - Outsourcing Facilities				
QC Analytic Laboratories Performing Release and Stability Testing				



construction, O&M for facilities associated with Phase-I and II clinical trials, with increasing requirements at each level.

NIH intends to design, build, and operate all APFs to meet the more stringent Phase-II, or better requirements, in lieu of the less restrictive Phase-I requirements to the extent practicable, and in a manner which prioritizes patient and worker safety.

Standing up and operating facilities in this manner are true to our mission and goals, particularly to exemplify and promote the highest level of scientific integrity, public accountability, and social responsibility in the conduct of science.

The following list of statutes, regulations, standards, and guidelines are in addition to those found in [Section 1.2 Referenced Codes, Standards, and Organizations](#). The user shall define the Current Good Manufacturing Practice (cGMP) and harmonized regulatory environment (GxP), applicable to the APF during the predesign phase, and adhered to throughout the design (where expanded into the URS and BOD), and later used as a reference point for commissioning, qualification, validation, operation and maintenance of these facilities.

#### **Statutes (Laws passed by Congress):**

##### **A. Federal Food, Drug, and Cosmetic Act (FD&C Act):**

1. Section 503 A & Amendments (Amended by the Compounding Quality Act, as described in Section 106(a) of the Act) - Pharmacy Compounding of Human Drug Products <Traditional Pharmacy>
2. Section 503 B - < Outsourcing Facility>

##### **B. Public Health Service Act (PHSA):**

1. Section 351 - Regulation of Biologics
2. Section 361 - Regulation of HCT/Ps

#### **Regulations (have the full force of the statute):**

##### **A. Title 21 Code of Federal Regulations (CFR), Chapter I - Food and Drug Administration (FDA), Department of Health and Human Services (DHHS):**

1. Subchapter C – Drugs: General
  - a. Part 210: Current Good Manufacturing

Practice in Manufacturing, Processing, Packing, or Holding Drugs, General

- b. Part 211: Current Good Manufacturing Practice for Finished Pharmaceuticals
2. Subchapter D – Drugs for Human Use
  - a. Part 312: Investigational new drug application
3. Subchapter F – Biologics
  - a. Part 600: Biological Products: General
  - b. Part 606: Current Good Manufacturing Practice for Blood and Blood Components
4. Subchapter L – Regulations under Certain Other Acts Administered by the FDA
  - a. Part 1270: Regulations of Human Tissue Intended For Transplantation
  - b. Part 1271: Regulations of Human Cells, Tissues, and Cellular and Tissue Based Products (HCT/P's)

##### **B. The United States Pharmacopeia and The National Formulary (USP-NF), latest edition**

##### **C. American Society of Mechanical Engineers (ASME) Bioprocessing Equipment Standard**

##### **D. International Basic Safety Standards for Protection against Ionizing Radiation and for the Safety of Radiation Sources (BSS)**

#### **Standards:**

##### **A. U.S. Pharmacopeia (USP) General Chapters:**

1. <795> Pharmaceutical Compounding — Nonsterile Preparations
2. <797> Pharmaceutical Compounding—Sterile Preparations
3. <800> Hazardous Drugs—Handling in Healthcare Settings
4. <823> Positron Emission Tomography — Compounding
5. <1046> Cellular and Tissue-Based Products <1116> Microbiological Controls and

## Monitoring of Aseptic Processing Environments

6. <1163> Quality Assurance in Pharmaceutical Compounding
7. <1168> Compounding for Phase-I Investigational Studies
8. <1231> Water for Pharmaceutical Purposes

**B. Institute of Environmental Sciences and Technology (IEST)**

1. IEST-RP-CC001: HEPA and ULPA Filters
2. IEST-RP-CC002.3: Unidirectional-Flow, Clean-Air Devices
3. IEST-RP-CC006.3: Testing Cleanrooms
4. IEST-CC012: Considerations in Cleanroom Design
5. IEST-RP-CC013.2: Calibration Procedures and Guidelines or Select Equipment Used in Testing Cleanrooms and Other Controlled Environments
6. IEST-CC018: Cleanroom Housekeeping: Operating and Monitoring Procedures
7. IEST-CC026: Cleanroom Operations
8. IEST-RP-CC034: HEPA and ULPA Filter Leak Tests
9. IEST-CC045: Design Considerations for Critical Exhaust Systems
10. IEST-CC047: Cleanroom Lighting
11. IEST-CC048: Guidance for Design, Performance, and Operations of Controlled Environments per USP 797 International Society of Pharmaceutical Engineers (ISPE)

**C. Baseline Pharmaceutical Engineering Guide for New and Renovated Facilities:**

1. Volume - 3: Sterile Product Manufacturing Facilities
2. Volume - 5: Commissioning and Qualification
3. Volume - 6: Biopharmaceutical Manufacturing Facilities

4. Volume - 7: Risk-Based Manufacture of Pharmaceutical Products

**D. International Standards Organization (ISO) - Cleanroom Standards:**

1. ISO 14644-1: Cleanrooms and Associated Controlled Environments – Part 1: Classification of air cleanliness by particle concentration
2. ISO 14644-2: Cleanrooms and associated controlled environments – Part 2: Monitoring to provide evidence of cleanroom performance related to air cleanliness by particle concentration
3. ISO 14644-3: Cleanrooms and associated controlled environments – Part 3: Test Methods
4. ISO 14644-4: Cleanrooms and Associated Controlled Environments–Part 4: Design, Construction and Startup.
5. ISO 14644-5: Cleanrooms and Associated Controlled Environments–Part 5: Operations
6. ISO 14644-6: Cleanrooms and Associated Controlled Environments–Part 6: Vocabulary
7. ISO 3746: Acoustics — Determination of sound power levels and sound energy levels of noise sources using sound pressure — Survey method using an enveloping measurement surface over a reflecting plane

**Guidelines:****A. Controlled Environment Testing Association:**

1. CAG-003-2006: Sterile Compounding Facilities
2. CAG-005-2007: Servicing Hazardous Drug Compounding Primary Engineering Controls
3. CAG-008-2010: CETA Certification Matrix for Sterile Compounding Facilities
4. CAG-009-2011v3: CETA Certification Application Guide USP <797> Viable Environmental Sampling & Gowning Evaluation

**B. Facility Guidelines Institute (FGI)'s Guidelines for Design and Construction of Hospitals and Outpatient Facilities****C. FDA Guidance for Industry (GFI):**

1. cGMP for Phase I Investigational Drugs
2. INDs for Phase II and Phase III Studies; Chemistry, Manufacturing, and Controls Information
3. Sterile Drug Products Produced by Aseptic Processing – Current Good Manufacturing Practice
4. PET Drugs — Current Good Manufacturing Practice (cGMP)
5. HCT/P Guide
6. Quality Systems Approach to
7. Pharmaceutical cGMP Regulations
8. Investigating Out-of-Specification (OOS) Test Results for Pharmaceutical Production
9. cGMP for Phase I Investigational Drugs
10. INDs for Phase II and Phase III Studies

**D. FDA – Other documents:**

1. CDER Manual of Policies and Procedures (MaPPs), 4723.1 Standing Operating Procedures for NDA/ANDA Field Alert Reports
2. Office of Regulatory Affairs, Chapter 4, Compliance Policy Guide

**E. Federal Register Notices for Proposed Changes and Final Changes to cGMP****F. International Society for Pharmaceutical Engineering (ISPE) - ISPE Good Practice Guides:**

1. Heating, Ventilation and Air Conditioning (HVAC)
2. Process Gases
3. Project Management for the Pharmaceutical Industry

**G. International Standards Organization (ISO) - ISO/IEC Guide 51, Safety aspects — Guidelines for their inclusion in standards****H. International Conference on Harmonization (ICH):**

1. ICH-Q7 Good Manufacturing Practice
2. ICH-Q9 Quality Risk Management National Environmental Balancing Bureau, Procedural Standards for Certified Testing of Cleanrooms

---

## 13.1.2 Coordination Between Statutes, Regulations, Standards, and Guidelines

The products produced in APFs are regulated by the local jurisdictional requirements, of both where the APF is located, and any extra-jurisdictional requirements of where the products are to be dispensed. A harmonization analysis shall be performed, giving full consideration to all applicable requirements, including extra-jurisdictional requirements, as applicable. These analyses shall be incorporated into the user's statement of requirements (SOR) and the derivative user requirement specification (URS), giving deference to the most stringent requirement when comparing multiple statutes, regulations, standards, and guidelines (i.e., cGMP and GxP). The harmonization report should also provide a rationale for each such determination. In instances where the most restrictive requirement is not obvious, a risk analysis shall be performed to determine the minimum requirement.

Caution should be taken in conducting harmonization analyses. Typically cGMP SMEs are engaged in the development of these analyses either to produce the report, as a consultant, or reviewer. The A/E shall compare the GMP and GxP requirements detailed in the draft harmonization report with the various "normal" building codes (IBC, Life safety code, etc.) and conduct their due diligence analyses. The final harmonization report shall describe the comprehensive regulatory environment for the APF at the initiation of the design phase, and serve as a basis for ongoing confirmation of conformance to all current requirements.

### 13.1.3 Definitions

Certain definitions listed below are the same as defined by the International Society for Pharmaceutical Engineering (ISPE) and Commission Electrotechnique Internationale (IEC). These are denoted with the organization's acronym in italics and brackets following the definition.

**Advanced Aseptic Processing:** The use of barrier technology that separates aseptic processes from operators and other background risks. This includes the application of both isolation and Restricted Access Barrier System (RABS) technologies as well as closed processing. See [Aseptic Processing](#).

**Air Change Rate / Ventilation Rate (similar to Air Changes per Hour, or ACH):** The calculated number of times the total air volume of a defined space is replaced in a given unit of time, calculated by dividing the total volumetric flow of the room supply (or exhaust, in some cases) by the gross volume of the room. Calculation of air changes should be calculated only on supply, and exclude transfer air or calculation based on room exhaust air.

**Airflow Visualization Study (AVS):** Verification of airflow patterns through the observation of the airflow-induced behavior of visible neutrally buoyant, non-charged particles in an airstream. This method allows for, determination of the potential impact of unintended airflow patterns with the intent of optimizing control of contamination in clean environments.

**Airlock:** A space with interlocked doors, constructed to maintain air pressure control when items or people move between two adjoining areas (generally with

different air cleanliness standards). The intent of an airlock is to prevent ingress of particulate matter and microbial contamination from a lesser-controlled area. Airlocks are commonly used for donning/doffing PPE and gowning as well as cleaning/sanitizing or otherwise preparing materials for entry to /exit of clean space. See [Bubble Airlock](#), [Cascade Airlock](#), [Sink Airlock](#), and [Figure 13.1.3](#).

**Ambient Environment:** The general environmental conditions in non-classified space where no HVAC systems are present.

**Anteroom** (This definition applies to APF Anterooms only, and supersedes descriptions within other DRM chapters.): A room that is used for donning/doffing personal protective equipment (PPE), and is often combined with an airlock function, and/or accommodates pass throughs and/or observation windows due to its proximal relationship to higher and lower ISO classified spaces. A room proximate to a manufacturing or compounding space, which is entered prior to the clean space; often an airlock.

**APF Spaces:** For the purposes of DRM Chapter 13, the sequence of spaces shall be considered:

1. **Building:** NIH owned or leased biomedical research and research support structure, as described per the NIH Facility Information Management System (FIMS).
2. **Facility:** A division of a building; the area within the boundary of the APF, its support and the mechanical and electrical rooms supporting the APF. Facility access shall be controlled per NIH Policy Manual Chapter 1406

**Figure 13.1.3 Airlock Configurations**

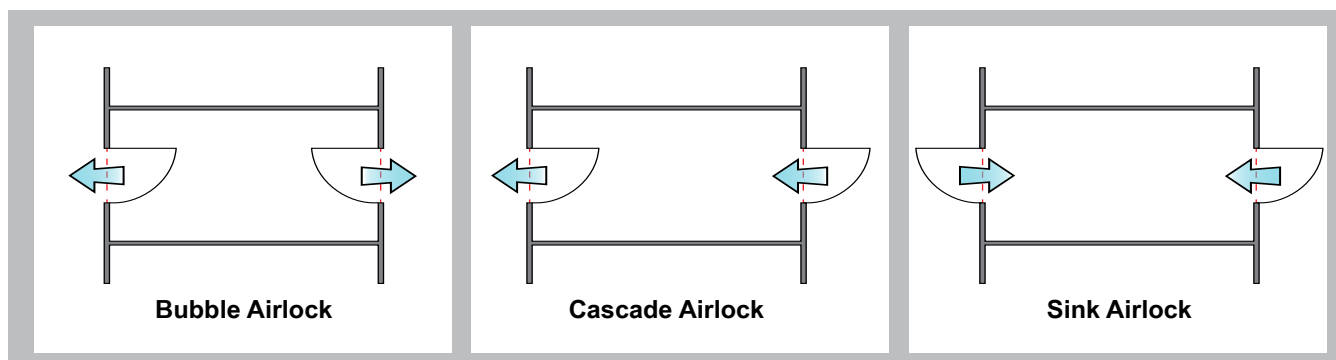

- Access to Manufacturing and Compounding for Human Administration Areas in NIH Facilities. The boundary of a facility is often not congruent.

3. **Suite:** A division of a facility. Each APF is comprised of one or more zones which may operate independently of one another to accommodate cleaning, maintenance, or production needs. Each of those rooms, or clusters of rooms is referred to collectively as a suite.
4. **Room:** A division of a suite enclosed by walls, floor, and ceiling.

**Aseptic:** Aseptic, is free from gross (i.e., visible to the unaided-eye) contamination, is regularly cleaned with appropriate materials, and techniques to inert and remove pathogenic microorganisms, leaving films of product which retard future biological activity. Aseptic areas shall be part of the environmental monitoring plan. Compare with “Clean.”

**Aseptic Processing:** A process by which separate, sterile components (e.g., drugs, containers, or closures) are brought together under conditions that maintain their sterility. The components can either be purchased as sterile or, when starting with nonsterile components, can be separately sterilized prior to combining (e.g., by membrane filtration, autoclave). Literally, processing without addition of microbial contamination.

**Aseptic Production Facility (APF):** Facilities which produce drug and/or biologic products for human injection, implantation, ingestion, inhalation, or absorption. This includes facilities where non-aseptic products are produced using aseptic practices.

**At-Rest (Static):** A cleanroom which is complete with all services functioning and with production equipment installed and capable of being operated or operating, as specified, but without operating personnel within the facility.

**Basis of Design (BOD):** See [Section 1.3](#). Additionally, this document begins to be authored during predesign and is progressively updated through design up to project closeout.

**Beyond-use date (BUD):** The date or time after which a Compound Sterile Preparation (CSP) cannot be stored, transported or used and must be discarded. The date

or time is determined from the date or time when the preparation was compounded.

**Biological Safety Cabinet (BSC):** A ventilated cabinet with unidirectional HEPA-filtered supply airflow and HEPA-filtered exhaust to protect workers from hazardous materials and maintain the cleanliness (asepsis) of product and process. A BSC is used to prepare a Compounded Sterile Preparation (CSP) and must be capable of providing and maintaining an ISO Class 5 environment or better.

**Biologics:** A biologic drug (biologics), produced from living organisms, or contain living organisms. Biologics include a wide range of products such as vaccines, blood and blood components used for transfusion and as a raw material for drug products, diagnostic and therapeutic allergenic extracts, cellular and tissue-based products (HCT/Ps), gene therapy, tissues (except vascularized organs for transplantation), recombinant therapeutic proteins, and vaccines for use in humans. Biologics can be composed of sugars, proteins, or nucleic acids or complex combinations of these substances, or may be living entities such as cells and tissues. Biologics are produced in APFs.

**Bubble Airlock:** An airlock configuration having a higher pressure inside the airlock to lower pressure on the outsides. This retards the flow of air between the adjacent rooms through the airlock by creating a high-pressure barrier. See [Cascade Airlock](#), [Sink Airlock](#), and [Figure 13.1.3](#).

**Buffer Area:** An ISO Class 7 (or ISO Class 8 if using an isolator) or cleaner area where the Primary engineering control (PEC) that generates and maintains an ISO Class 5 environment is physically located.

**Calibration:** The act of comparing an instrument of unknown accuracy with a standard of known accuracy to detect, correlate, report, or eliminate by adjustment any variation in the accuracy of the tested instrument. The periodicity of re-calibration of each facility instrument must be delineated in the URS unless a calibration program standard operating procedure (SOP) exists for that facility.

**Calibration Management:** The facility program within NIH APFs, whose purpose is to ensure that any measuring or detection instrument or system that monitors conditions that have a direct or indirect impact on



product quality, safety, purity and efficacy is operating within its specified accuracy and tolerance. Typically, this includes temperature, humidity, and differential pressure, but may include others on a site-by-site basis.

**Cascade Airlock:** An airlock configuration having a higher pressure on one side of the airlock to lower pressure on the other side of the airlock. This retards the flow of air between the adjacent rooms through the airlock where the dusts and other contaminants are of a primary concern in a single direction. See [Bubble Airlock](#), [Sink Airlock](#), and [Figure 13.1.3](#).

**Classified Space:** Areas where HVAC systems are specifically designed to reduce airborne contaminants below a specified level (as defined in ISO classes) and both temperature and relative humidity (RH) are controlled more tightly than in the ambient environment. These areas must be performance verified/qualified. ISO Classification:

1. **Temperature Controlled:** Areas where HVAC systems are specifically designed to control both temperature and (where applicable) Relative Humidity (RH) more tightly than in the ambient environment. Temperature and RH are typically qualified in these areas and temperature mapping is expected. This designation is typically found in warehouse spaces, cold rooms, and logistics support spaces.
2. **Uncontrolled (UC):** Areas where the HVAC systems may be present, but no claim is made or qualified for the specific control of particulate, temperature or humidity. These areas are sometimes referred to as “General” or “Comfort Controlled” areas within pharmaceutical facilities such as offices and technical spaces. May also be designated “Not Controlled (NC)”.
3. **Controlled Not Classified (CNC):** Areas where HVAC systems are specifically designed to reduce airborne contaminants below the level of the ambient environment and both temperature and Relative Humidity (RH) are controlled more tightly than in the ambient environment. Qualification is common. No claim is made or qualified for the specific control of particulate. Typical systems will have heating, cooling and filtration meeting MERV 13 or better.
4. **Controlled Not Classified with Local Monitoring (CNC+):** These areas are typically qualified to meet ISO 8 requirements at rest only, to control temperature and humidity within a specified band. These areas are generally aligned with PIC/S designation “Grade D.”
5. **Class-8:** A classified space that satisfies the Food and Drug Administration, United States Department of Health and Human Services (FDA) requirements for ISO 8 measured via airborne 0.5µm particulate in the “in-operation” state, as well as EMA and PIC/S requirements to meet ISO 8 measured via airborne 0.5µm and 5.0µm particulate in the “in-operation” state and meet ISO 7 measured via airborne 0.5µm and 5.0µm particulate in the “at-rest” state.
6. **Class-7:** A classified space that satisfies FDA requirements for ISO 7 measured via airborne 0.5µm particulate in the “in-operation” state, as well as European Medicine Agency (EMA) and Pharmaceutical Inspection Cooperation/Scheme (PIC/S) requirements to meet ISO 7 measured via airborne 0.5µm and 5.0µm particulate in the “in-operation” state and meet ISO 5 measured via airborne 0.5µm and 5.0µm particulate in the “at-rest” state.
7. **Class-5:** A classified space that satisfies FDA requirements for ISO 5 measured via airborne 0.5µm particulate in the “in-operation” state, as well as EMA and PIC/S requirements to meet ISO 5 measured via airborne 0.5µm particulate and ISO 4.8 measured via airborne 5.0µm particulate in the “in-operation” and “at-rest” states.

**Clean:** Clean indicates a condition which is free from gross contamination upon visual inspection and regularly cleaned with appropriate materials, and techniques to retard biological activity. Clean areas may be part of the environmental monitoring plan. Compare with “Aseptic.”

**Clean Corridor:** A design element in APFs, within the facility, where properly gowned persons can traverse between various areas, typically starting at the main entry of the suite. The clean corridor is principally used to provide a unidirectional flow within the facility.



Within the clean corridor, air quality is specified and monitored, and it is included in the EM plan. Contrast with “Return Corridor.”

**Cleanroom:** A specially constructed room in which the air supply, air distribution, filtration of air supply, materials of construction, and operating procedures are regulated to control airborne particle concentrations to meet appropriate cleanliness levels and other relevant parameters (i.e., temperature, humidity, pressure, etc.) as defined in ISO classifications or any other regulatory entity.

**Cleanroom Performance Testing (CPT):** The act of evaluating the performance of a cleanroom by performing a series of defined tests with prescribed procedures and reporting requirements. The most common and critical of these are airborne particulate classification (certification) and monitoring.

**Closed Process:** A process condition when the product, materials, critical components or container/closure surfaces are contained and separated from the immediate process environment within closed/sealed process equipment. A process step (or system) in which the product and product contact surfaces are not exposed to the immediate room environment. [ISPE]

**Colony-Forming Unit (CFU):** A unit used to estimate the number of viable (defined as the ability to multiply under controlled conditions) bacteria or fungal cells in a sample. Counting with colony-forming units requires culturing the microbes then counting only viable colonies. There is a certain, understood degree of uncertainty associated with this type of counting, as opposed to microscopic examination, which furnishes a total cell count (viable and non-viable cell count).

**Commissioning:** APF commissioning is a quality oriented process for verifying and documenting that the performance of facilities, systems and assemblies meets the objectives and criteria as defined in the Commissioning Master Plan.

**Compound Sterile Preparation (CSP):** A preparation intended to be sterile that is created by combining, diluting, pooling, or otherwise altering a drug product or bulk drug substance.

**Compounding Aseptic Isolator (CAI):** A type of physical barrier system (enclosure) that uses HEPA Filtration to provide an ISO Class-5 clean air environment, designed to give high sterility assurance for the aseptic compounding of sterile drugs. A CAI must provide a high-integrity material transfer component; provide an automated sporocidal decontamination system, and maintain a significant overpressure to the surrounding environment. Operator access into a CAI is usually via fixed gloves integrated into the wall of the unit.

**Compounding Aseptic Containment Isolator (CACI):** A type of Compounding Aseptic Isolator, designed for the compounding of sterile hazardous drugs. A CACI is similar to a CAI, but may not be positively pressurized to the surrounding room and may possess other features (e.g., transfer airlocks) to minimize the release of drug or drug products into the surrounding environment.

**Contaminant:** Any particulate, molecular, non-particulate and biological entity that can adversely affect the product or process.

**Contamination:** Adulteration of a product by the introduction of impurities of a chemical or microbiological nature or, foreign matter, into or onto, a starting material or intermediate, during production, sampling, packaging, repacking, storage and transport. Contamination poses a significant risk to patient and worker safety. The design, construction, operation and maintenance of APFs are intended to lower the likelihood of the occurrence of contamination.

**Critical Component:** A component within a system where the operation, contact, data, control, alarm, or failure may have a direct impact on product quality or the ability to know product quality. [ISPE]

**Critical Location:** The location where the product is exposed and/or the location where a cleaned product contact surface is exposed.

**Critical Process Parameter (CPP):** A process parameter whose variability impacts a quality attribute and therefore needs to be controlled to ensure the process produces the desired quality. [ISPE]

**Critical Quality Attribute (CQA):** A physical, chemical, biological or microbiological property or characteristic that needs to be controlled (directly or indirectly) to ensure product quality. [ISPE]

**Cross-Contamination:** Contamination of a starting material, intermediate product, or finished product by another material or product.

**Dead Band:** A setpoint range established to prevent unintended system reaction, such as simultaneous heating and cooling.

**Design Qualification:** Documented verification that the proposed design of the facilities, equipment, or systems is suitable for the intended purpose. See [Section 13.16.4 Qualification Plan \(QP\)](#). [ISPE]

**Design Target:** A value for a critical parameter that is more conservative than its acceptance criterion, used by designers to assure that the system is capable of meeting the acceptance criterion. Design Targets should not be used for system qualification; they are aspirational values that may not be achieved in reality. [ISPE]

**Differential Pressure ( $\Delta P$ ):** The difference between two pressures measured between a sample point and reference point.

**Dilution Ventilation:** Reduction in airborne contamination via mixing of clean incoming air with contaminated air within the room and removal of an equivalent amount to exhaust or recirculation via treatment (e.g., filtration).

**Direct Impact System:** A system that is expected to have a direct impact on product quality. These systems are designed and commissioned in line with Good Engineering Practice and also are subject to Qualification Practices that incorporate the enhanced review, control and testing against specifications or other requirements necessary for GMP compliance. [ISPE]

**Disinfecting Agent:** A chemical agent that destroys vegetative forms of harmful microorganisms (such as bacteria and fungi) but that may be less effective in destroying spores. Disinfecting agents kill/inert 100% of the bio-active particles on the surface (may require pre-cleaning), including 100% of vegetative bacteria, target viruses and target fungi. The efficacy of the agent is dependent on concentration, time, temperature, surface characteristics, and the bioburden present on the surface.

**Displacement Ventilation:** Reduction in airborne contamination via “plug flow” of clean incoming air

forcing contaminated air within the room to exhaust or recirculation via treatment (e.g., filtration).

**Drug:** A drug is a substance intended for use in the diagnosis, cure, mitigation, treatment, or prevention of disease and intended to affect the structure or any function of the body of human or animal, but not a device or component, or accessory of a device. Drugs are manufactured in APFs.

**Dynamic Conditions:** Testing performed simultaneously with real or simulated operational activities, including garbing, people, and processes.

**Excipient:** A pharmacologically inactive substance formulated alongside the active pharmaceutical ingredient of a medication, included for the purpose of long-term stabilization; for bulking up solid formulations that contain potent active ingredients in small amounts; or to confer a therapeutic enhancement on the active ingredient in the final dosage form, such as facilitating drug absorption, reducing viscosity, or enhancing solubility.

**Exit/Return Corridor:** A design element in unidirectional APFs where properly gowned persons can traverse between various areas within the facility, typically starting at the exit of the processing rooms/anterooms, continuing to the exit. The exit/return corridor is principally used to provide a unidirectional flow within the facility and provides a route to equipment rooms, freezer rooms, waste collection areas, etc., then back to the entrance to the suite for reentry, with appropriate donning/doffing of PPE as required by SOP. Within the exit/return corridor, air quality may be specified, monitored, and included in the EM plan.

**Facility Critical Parameter:** A room variable, such as temperature, humidity, air changes, room pressure, viable/non-viable particle counts, etc. that can negatively impact product production or storage.

**Failure Mode and Effects Analysis (FMEA):** A procedure for reliability analysis intended to identify failures, at the basic component level, which has significant consequences affecting the system performance in the application considered. [IEC & ISPE]

**First Air:** Undisrupted airflow coming directly from a HEPA filtered source into a room, whether by the supply air system, or a HEPA-filtered recirculation system. It specifically excludes transfer air and exhaust air.

**Filter Integrity Test:** A test to identify very fine leaks within HEPA filters, performed by injecting a challenge aerosol of fine particles (usually Poly Alpha Olefin – PAO) upstream of the filter media, measuring the downstream concentration of the particulate across each square inch of the filter face and calculating the penetration to determine if that square area meets or exceeds a target penetration. Consistent with FDA recommendations, the target penetration shall be less than 0.01%.

**Good Clinical Practice (GCP):** An international quality standard that is provided by ICH, an international body that defines a set of standards, which governments can then transpose into regulations for clinical trials involving human subjects.

**Good Documentation Practice (GDP):** A term used to describe standards by which documents are created and maintained. While some GDP standards are codified by various regulations, others are not, but still considered part of a cGMP Quality Management System. GDP, enable communications of intent and consistency of actions (ISO 9000: 2000).

**Good Engineering Practice (GEP):** Established engineering methods and standards that are applied throughout a project's life-cycle to deliver appropriate, cost-effective solutions. [ISPE]

**Good Laboratory Practice (GLP):** A set of principles intended to assure the quality and integrity of non-clinical laboratory studies that are intended to support research or marketing permits for products regulated by government agencies.

**Good Manufacturing Practice (GMP):** A system for ensuring that products are consistently produced and controlled according to quality standards. It is designed to minimize the risks involved in any pharmaceutical production that cannot be eliminated through testing the final product.

**Good Practice (GxP):** GxP is a generally, summary term which serves as an abbreviation for "Good Practice." In APFs, the term GxP is related to Good Laboratory Practice (GLP), Good Manufacturing Practice (GMP), Good Clinical Practice (GCP), Good Tissue Practice (GTP), Good Documentation Practice (GDP), and Good Engineering Practice (GEP). In many cases, the

full detail of the individual GxPs is detailed in statutes, regulation, and/or guidelines.

**GxP Harmonization Analysis:** The process by which the totality of GxP affecting a given facility (statutes, regulations, standards, and guidelines) are reviewed; conflicts identified; and, with appropriate risk analyses, a resolution to those conflicts are determined, and documented. The analysis must include a narrative describing how each determination was made. The most restrictive condition shall prevail.

**GxP Environment:** A term that describes the totality of the regulatory environment for a facility, including, but is not limited to adherence to applicable:

- Statutes, Regulations, Standards and Guidelines
- Regulatory Agency Guidance
- Regulatory Citations (e.g., FDA 483s)
- Good Engineering Practice (GEP)
- Good Manufacturing Practice (GMP)
- Good Clinical Practice (GCP)
- Good Laboratory Practice (GLP)
- Good Documentation Practice (GDP)

**Grandfathering:** A concept that is typical in design and construction codes, wherein new codes, when promulgated, are enforceable on new construction, and are not retroactively enforceable on existing building stocks. Grandfathering does not exist in cGMP environments, where, compliance with the "current" best practices and GxP regulatory environments are mandatory.

**Hazardous Drug:** Any drug identified by at least one of the following six criteria: carcinogenicity, teratogenicity or developmental toxicity, reproductive toxicity in humans, organ toxicity at low dose in humans or animals, genotoxicity, or new drugs that mimic existing hazardous drugs in structure or toxicity.

**ISO Class:** An air quality classification from the International Organization for Standardization, per ISO 14644-1 standards, which specify the cleanliness of spaces by airborne particulate via decimal logarithm of the number of particles 0.1  $\mu\text{m}$  or larger permitted per cubic meter of air.

**Laminar Airflow Workbench (LAFW):** A cabinet that provides an ISO Class 5 or better environment for sterile compounding. The device provides a unidirectional HEPA-filtered airflow across the work area.

**Media Fill Test:** A simulation used to qualify processes and personnel engaged in sterile compounding to ensure that the processes and personnel are able to produce sterile CSPs without contamination.

**Microbial Contamination:** The presence of microorganisms in, or on, an item.

**Minimum Efficiency Reporting Value (MERV):** the ASHRAE 52.2 method of testing filter efficiency by challenging filters with particles of multiple sizes and integrating the efficiency into a single number rating. The higher the MERV number the more efficient the filter. MERV 14/15 is approximately equivalent to a 95% (ASHRAE 52.1) efficient filter.

**Non-Unidirectional Airflow Cleanroom:** Air distribution where the supply air entering the clean zone mixes with the internal air by means of induction.

**Occupancy State(s):** Three conditions of various stages of testing of a cleanroom: As-Built, At-Rest, and Operational.

**Operating Range:** The validated acceptance criteria within which a control parameter must remain, wherein acceptable product is being manufactured. [ISPE]

**Operational Facility:** A cleanroom which is complete with all services functioning, and with production equipment installed and operating under normal conditions with all operating personnel present.

**Pass Through:** An enclosure with seals on interlocking doors that are positioned between two spaces for the purpose of minimizing particulate transfer while moving materials from one space to another.

**Particle:** A solid or liquid object which, for purposes of classification of air cleanliness, has a threshold (lower limit) size of 0.5 microns ( $\mu\text{m}$ ).

**Particle Count:** Concentration expressed in terms of the number of particles per unit volume of air. Normally associated with the particles in the cleanroom or clean zone.

**Particle Generation Rate:** The number of particles of a specified size range released into a room (per hour) by processes, people, or in the supply air.

**Phase I Clinical Trial:** A clinical trial that uses a small group of patients and looks at the highest dose of the new treatment that can be given safely without serious side effects. It is the safety aspect of the trial.

**Phase II Clinical Trial:** A clinical trial that uses a larger group of patients to provide more information about the treatment's safety and how well it works. This is the efficacy phase of the drug trial.

**Pharmaceutical Inspection Co-operation Scheme (PIC/S):** PIC/S is the abbreviation and logo used to describe both the Pharmaceutical Inspection Convention (PIC) and the Pharmaceutical Inspection Co-operation Scheme (PIC Scheme) operating together in parallel.

**Primary Engineering Control (PEC):** A device or zone that provides an ISO Class 5 environment for sterile compounding. This terminology may also be used for process closure or other technology which excludes contaminants from the product.

**Piping and Instrumentation Diagram (P&ID):** Detailed diagrams which describe systems, and schematically indicates the configuration of the system and its components. The diagram indicates physical characteristics, such as pipe size, valves, equipment, etc. It also indicates the sensors, instrumentation, and control functions or interlocks.

#### **Process Diagrams:**

1. **Block Flow Diagram (BFD):** These diagrams are developed early in the project planning process to schematically depict the intended flows of the intended processes for the facility. The blocks describe different equipment or operations which are connected by directional input and output streams that describe the intended function of a facility. Critical information about unique processes should be noted. This document is subject to review and sign-off.
2. **Process Flow Diagrams (PFD):** Subsequent to the BFD, and represents a significant advance in detail and specification over the prior document. All major pieces of equipment shall

be represented on the diagram, each with a unique identifier and descriptive name. All process streams shall be shown and identified by number. Basic control loops, illustrating the control strategy shall be shown. Integral to the PFD package is a narrative process description and equipment descriptions. This is a complex document that will be integral to the design process, updated and resubmitted along with all design submissions after 50%. This document is subject to review and sign-off, under document control. For additional information, see [Section 13.3.9 SOP for Construction](#).

3. **Piping and Instrumentation Diagram (P&ID):** Each PFD may require multiple P&IDs, depending on complexity. These diagrams shall comply with ISA Standard ISA-S5-1. This is a comprehensive diagram which describes systems, and schematically indicates the configuration of the system and its components. The diagram indicates physical characteristics, such as pipe size, valves, equipment, etc. It also indicates the sensors, instrumentation, and control functions or interlocks. Only one operation is depicted on each diagram. This diagram will be updated to an as-built document and maintained throughout the life cycle of the project. This document is subject to review and sign-off, under document control.
4. **Material, Equipment and Personnel Flow Diagrams (MEPF):** These diagrams are a component of the URS, and must be regularly updated to reflect changes to the facility. These diagrams are to be single-process flow only. The number and subject of these diagrams will vary by facility. Diagrams may include, but not be limited to PPE Zones; and flows, such as Raw Material, Waste Material, Personnel, Equipment, Finished Product, etc. See [Section 13.2.3 Documentation \(Predesign\)](#).

**Project Closeout/Handover:** The demarcation between the construction phase and when the user initiates their Performance Qualification (PQ). This milestone is characterized by the facility acceptance of the documents and facility as described in [Section Section 13.18 Project Closeout and Facility Handover Phase](#).

**Qualification:** The process of determining that a specific system, facility and/or equipment is able to achieve the acceptance criteria as defined in the Validation Master Plan (VMP), documenting that it is fit/ready for intended use, and it conforms to design specifications. Commissioning + Enhanced Documentation = Qualification.

**Quality Assurance (QA):** A part of the Quality Control Unit (QCU) responsible for developing a system of procedures, activities, and oversight that ensures that operational and quality standards are consistently met. GMP QA primarily involves (1) review and approval of all procedures related to production and maintenance, (2) review of associated records, and (3) auditing and performing/evaluating trend analyses. APF QA primarily involves (1) review and approval of all procedures related to production and maintenance, (2) review of associated records, (3) auditing and performing/evaluating trend analyses, and (4) review and approval of all proposed construction and maintenance work within APFs or on systems which support APFs to ensure ongoing under control operation of the facilities and conformance with GxPs.

**Quality Control (QC):** A part of the Quality Control Unit (QCU) responsible for implementing a system of procedures, activities, and oversight that defined by Quality Assurance, to ensure that operational and quality standards are consistently met. GMP QC usually involves (1) assessing the suitability of incoming components, containers, closures, labeling, in-process materials, and the finished products; (2) evaluating the performance of the manufacturing process to ensure adherence to proper specifications and limits; and (3) determining the acceptability of each batch for release. APF QC primarily involves the review and inspection of construction and maintenance activities for conformance with the design requirements and work plans, approved in advance by the APF QA (FCIS).

**Quality Control Unit (QCU):** A synonym for the Quality Unit, sometimes used by the FDA.

**Quality Unit:** A group within an organization who is tasked by cGMP regulation with the responsibility and authority to create, monitor, and implement a quality system. Such activities do not substitute for, or preclude, the daily responsibility of manufacturing personnel to build quality into the product. Current industry practice



generally divides the responsibilities of the quality control unit (QCU), as defined in the cGMP regulations, between quality control (QC) and quality assurance (QA) functions.

**RACI Matrix:** A matrix that defines who will do the work and be responsible for its completion (R), who will remain accountable for the completion of the work (A), who will be consulted as the work is being progressed (C), and who should be informed of the work upon completion (I).

**Range:** The upper and lower limits of an instrument's ability to measure the value of a quantity for which the instrument is calibrated.

**Record Documents:** For APF projects, the DRM recognizes the AIA definitions of the following (See [Section 13.18 Project Closeout and Facility Handover Phase](#) for additional description of non-drawing project record documents):

1. **As-Designed Record Drawings:** Record of everything the Architect and Engineer(s) designed for the Project, and includes the original Construction Documents plus all addenda, Architect's Supplemental Instructions, Change Orders, Construction Change Directives and minor changes in the work – typically a full set of editable CAD files and PDF files of each sheet.
2. **As-Constructed Record Drawings:** Record of the Project as constructed based on information the contractor provides to the Owner/Government under the contract for construction - typically color scan of the contractor's field set with all markups.
3. **Record of the Work As Constructed Drawings:** Record of the Project as constructed based on information the Contractor provides to the Owner Government under the contract for construction coupled with re-survey by the Architect and Engineer(s) – typically a full set of editable CAD files and PDF files of each sheet, BIMs; editable MS Word and indexed PDF files of the BOD and specifications.

**Recovery:** A test defined in ISO 14644-3 that challenges room environmental performance by measuring the time required for contamination to reduce by a stipulated amount, generally one or two log, after the particle generation in the space ceases.

**Restricted Access Barrier System (RABS):** A type of physical barrier enclosure for aseptic processing or compounding of sterile drugs. A RABS is similar to a CAI, but may return air to the room without internal recirculation and lacks a gaseous decontamination system. The term “open RABS” refers to a RABS where air is returned to the room, while a “closed RABS” employs primarily internal recirculation as is more similar to a CACI. Operator access into a RABS is usually via fixed gloves integrated into the wall of the unit. The background for a RABS should meet ISO 7 “in-operation”.

**Risk Assessment (RA):** Risk assessment is a process conducted to identify and mitigate risks to the product. Risk assessments shall be performed in accordance with ICH Q9, “Quality Risk Management,” using appropriate procedures, facilitators, and structured tools. The assessment shall be limited to cGMP compliance risks associated with the facility design/construction, including personnel, equipment, and material movement, etc. Every step in the processes shall be reviewed for susceptibility, to contamination and cross-contamination. See [Section 13.2.3 Documentation \(Predesign\)](#).

Risk assessment is initially provided by the user under Statement of Requirements (SOR) during the predesign phase which are later developed into a facility design/construction risk assessment during the design phase. Risk assessments are then performed throughout the life cycle of the project/facility, as needed. Risk assessments become separate, signed, change controlled documents upon acceptance. These Risk Assessments will be reviewed and revised, as required by SOP.

**Risk Management:** Per ICH Q9, systematic application of quality management policies, procedures, and practices to the tasks of assessing, controlling, communicating and reviewing risk, or similar methodology.

**Sanitizing Agent:** An agent that reduces the viability of bacteria, viruses, and fungi by killing/inerting >99.9% of bio-active particles remaining on the surface after pre-cleaning. The efficacy of the agent is dependent on concentration, time, temperature, surface characteristics, and the bioburden present on the surface.



**Sink Airlock:** An airlock configuration having lower-pressure inside the airlock to higher pressure on the outsides. This retards the flow of air between the adjacent rooms through the airlock by creating a low-pressure barrier. See [Bubble Airlock](#), [Cascade Airlock](#), and [Figure 13.1.3](#).

**State of Control:** Describes the condition where the direct and indirect impact processes, equipment and facility are operating with stability, and within the ranges specified in the URS, and in a manner which maximizes the probability that the product being produced will meet all quality requirements.

**Static Conditions:** Testing performed without real or simulated operational activities (see “at-rest”).

**Sterilizing Agent:** An agent that kills/inerts 100% of the bio-active particles, including all microorganisms and spores, on the surface after pre-cleaning. The efficacy of the agent is dependent on concentration, time, temperature, surface characteristics, and the bioburden present on the surface.

**Subject Matter Expert (SME):** A person who is an authority in a particular subject, possessing in-depth knowledge and understanding of the subject based upon their education, training, and experience, and an awareness of the history and current technology trends, issues and research in that subject.

**Testing, Adjusting, and Balancing (TAB):** TAB is a systematic process or service applied to heating, ventilating and air conditioning (HVAC) systems and other environmental systems to achieve and document air and hydronic flow rates. The periodicity of re-TAB shall be described in the URS.

**Transfer Air:** Air movement, through door opening cycles, leakage of door seals or around penetrations, via transfer grills, or other means. Transfer air is not to be used in the calculation of air change rates in APF, even if the source room is of equal or greater classification to the room the air enters.

**Training Records:** Documentation of who was trained, when they were trained, the mastery of the training that they have demonstrated, who trained them, the duration of the training currency, and a copy of all training materials used in that training.

**Unidirectional Airflow:** Controlled airflow through the entire cross-section of a clean zone with a steady velocity and approximately parallel streamlines.

**User Requirement Specification (URS):** A document that describes the project requirements and acceptance criteria for a facility. The URS describes process and system flows, as well as warning and alert values for environmental constraints. This document is authored during predesign and progressively updated through the life cycle of a facility to be current. This document is subject to change control.

**Validation:** Establishing documented evidence that a process or system, when operated within established parameters can perform effectively and reproducibly to produce a product meeting its predetermined specifications and quality attributes. Validation is establishing documented evidence to provide a high degree of assurance that a specific system, process or facility will consistently produce a product meeting its predetermined specifications and quality attributes. [ISPE]

**Validation Master Plan (VMP):** A user-initiated, multidisciplinary document which creates the structure for the quality management process, including all validations required to open and operate an APF. It shall identify processes and equipment to be validated, the schedule of their performance/time constraints, and the periodicity or conditions for required revalidation. The VMP should establish the philosophy, intentions, and approaches for establishing validation adequacy, as well as requirements for execution and reporting. The VMP shall be reviewed not less than annually, and the plan for that review shall be incorporated into the VMP. The VMP shall take into account all applicable regulations, codes, guides, SOPs, GDP, and GMP. This document is subject to review and sign-off, under document control. See [Section 13.16.2 Project Validation Master Plan \(PVMP\)](#).

**Vector:** In molecular cloning, a vector is a DNA molecule used as a vehicle to artificially carry foreign genetic material into another cell, where it can be replicated and/or expressed.

**Work Zone:** An area within the cleanroom which is designated for clean work and for which CPT is required. The work zone shall be identified by an entrance and exit plane normal to the airflow (where there is unidirectional airflow).

### 13.1.4 Abbreviations

The following list of abbreviations is provided for the benefit of the reader.

#### A

**ACH** – Air Changes per Hour

**AFT** – Airflow Test

**AHRI** – Air Conditioning, Heating & Refrigeration Institute

**APD** – Airflow Pressure Differential Test

**APF** – Aseptic Production Facility

**APT** – Airborne Particle Test

**AQM** – Air Quality Monitoring

**ASME** – American Society of Mechanical Engineers

**AVS** – Airflow Visualization Study

**AZM** – Auto Zero Modules

#### B

**BAS** – Building Automation System

**BEA** – Business Essential Attributes

**BFD** – Block Flow Diagram

**BOD** – Basis of Design

**BSC** – Biological Safety Cabinet

**BSS** – Basic Safety Standards

**BUD** – Beyond-use Date

#### C

**CA** – Compressed Air

**CACI** – Compound Aseptic Containment Isolator

**CAI** – Compounding Aseptic Isolator

**CAPA** – Corrective and Preventative Action

**CAS** – Coating Application Specialist

**CCTV** – Closed Circuit Television

**CBER** – Center for Biologics Evaluation and Research

**CD** – Construction Document Phase

**CDER** – Center for Drug Evaluation and Research

**CETA** – Controlled Environment Testing Association

**CFR** – Code of Federal Regulations

**CFU** – Colony-Forming Unit

**cGMP** – Current Good Manufacturing Practice

**CIP** – Coating Inspector Program

**CIP** – Clean-in-Place

**CIT** – Cleaning Integrity Test

**CMMS** – Computerized Maintenance Management System

**CMP** – Commissioning Master Plan

**CNC** – Controlled Not Classified

**CNC +** – Controlled Not Classified with Local Monitoring

**CO** – Contracting Officer

**CO<sub>2</sub>** – Carbon Dioxide

**COR** – Contracting Officer Representatives

**C-PEC** – Containment Primary Engineering Control

**CPP** – Critical Process Parameter

**CPT** – Cleanroom Performance Testing

**CPVC** – Chlorinated Polyvinyl Chloride

**CQ** – Construction Qualification  
**CQA** – Critical Quality Attribute  
**CQM** – Certified Quality Manager  
**CQP** – Construction Quality Plan  
**CQV-PM** – Commissioning, Qualification, and Validation Project Manager  
**CSA** – Critical Safety Attributes  
**C-SCA** – Containment Segregated Compounding Area  
**CSP** – Compounded Sterile Preparation  
**CSV** – Computer System Validation  
**CUP** – Central Utility Plant  
**CV** – Cleaning Validation  
**Cx** – Commissioning

---

## **D**

**DCS** – Distributed Control System  
**DD** – Design Development Phase  
**DEP** – Division of Environmental Protection  
**DFM** – Division of Fire Marshall  
**DFOM** – Division of Facilities Operations and Maintenance  
**DHHS** – Department of Health and Human Services  
**DOP** – Dioctyl Phalate  
**dP** – Differential Pressure  
**DQ** – Design Qualification  
**DTR** – Division of Technical Resources  
**DVR** – Digital Video Recorder

## **E**

**E-ACR** – Effective Air Change Rate  
**EF** – Exhaust Fan  
**EM** – Environmental Monitoring  
**EMA** – European Medicine Agency  
**EMS** – Environmental Monitoring System  
**EMT** – Electric Metallic Tubing  
**EU** – European Union

---

## **F**

**FAT** – Factory Acceptance Test  
**FCIS** – Facility Compliance and Inspection Services  
**FD&C Act** – Federal Food, Drug, and Cosmetic Act  
**FDA** – United States Food and Drug Administration  
**FDCA** – The Federal Food, Drug and Cosmetic Act  
**FFU** – Fan-filter Unit  
**FGI** – Facility Guidelines Institute  
**FIMS** – Facility Information Management System  
**FIT** – Filter Integrity Test  
**FM** – Factory Mutual Global  
**FMEA** – Failure Mode and Effects Analysis  
**FPE** – Fire Protection Engineer  
**FRP** – Fiber-Reinforced Plastic

## **G**

**GCP** – Good Clinical Practice

**GDP** – Good Documentation Practice

**GEP** – Good Engineering Practice

**GFI** – Guidance for Industry

**GLP** – Good Laboratory Practice

**GMP** – Good Manufacturing Practice

**GxP** – Good Practice

---

## **H**

**HD** – Hazardous Drugs

**HDPE** – High Density Polyethylene

**HMI** – Human Machine Interface

**HVAC** – Heating, Ventilation and Air Conditioning

---

## **I**

**IEST** – Institute of Environmental Sciences and Technology

**IPM** – Integrated Pest Management

**IPT** – Integrated Project Team

**IQ** – Installation Qualification

**ISO** – International Standards Organization

**ISPE** – International Society of Pharmaceutical Engineers

**IV** – Intravenous

## **K**

**KPI** – Key Performance Indicator

---

## **L**

**LAFW** – Laminar Airflow Workbench

**LAN** – Local Area Network

**LEED** – Leadership in Energy and Environmental Design

**LN<sub>2</sub>** – Liquid Nitrogen

**LOD** – Line of Demarcation

**LUT** – Lighting Uniformity Test

---

## **M**

**MEPF** – Material, Equipment and Personnel Flow Diagrams

**MERV** – Minimum Efficiency Reporting Value

**MPPs** – Manual of Policies and Procedures

**MUS** – Modular Unit System

---

## **N**

**N<sub>2</sub>** – Nitrogen

**NEC** – National Electrical Code

**NEEB** – National Environmental Balancing Bureau

**NRC** – Nuclear Regulatory Commission

## O

O&M – Operation and Maintenance  
 O<sub>2</sub> – Oxygen  
 OA – Optional Attributes  
 OA – Outside Air  
 OOS – Out-of-Specification  
 OQ – Operational Qualification  
 ORF – Office of Research Facilities  
 ORSC – Office of Research Support and Compliance

PM – Project Manager  
 PM – Preventive Maintenance  
 PMI – Project Management Institute  
 PMI-RMP – PMI Risk Management Professional  
 PMP – Project Management Professional  
 PO – Project Officer  
 POR – Program of Requirements  
 PQ – Performance Qualification  
 PVMP – Project Validation Master Plan

## P

P&ID – Piping and Instrumentation Diagram  
 PAO – Poly Alpha Olefin  
 PdM – Predictive Maintenance  
 PEC – Primary Engineering Control  
 PEM – Project Execution Manager  
 PEP – Project Execution Plan  
 PET – Positron Emission Tomography  
 PFD – Process Flow Diagrams  
 PgMP – Program Managements Professional  
 PHSA – Public Health Service Act  
 PI – Product Information  
 PIC/S – Pharmaceutical Inspection Cooperation /  
 Scheme  
 PLC – Programmable Logic Controller

## Q

QA – Quality Assurance  
 QC – Quality Control  
 QCU – Quality Control Unit  
 QP – Qualification Plan/Protocol  
 QRM – Quality Risk Management  
 QVxA – Qualification/Validation Authority

## R

RA – Risk Assessment  
 RABS – Restricted Access Barrier System  
 RCA – Root Cause Analysis  
 RDS – Room Data Sheets  
 RH – Relative Humidity

## **S**

**SAT** – Site Acceptance Test  
**SD** – Schematic Design Phase  
**SEC** – Secondary Engineering Controls  
**SLIA** – System Level Impact Assessment  
**SME** – Subject Matter Expert  
**SOP** – Standard Operating Procedures  
**SOW** – Statement of Work  
**SPD-2** – Surge Protection Device  
**SPT** – Sound Pressure Test  
**SSPC** – Society for Protective Coatings

---

## **T**

**TAB** – Testing, Adjusting, and Balancing  
**TT&MT** – Temperature and Moisture/Humidity Transmitters  
**TUT** – Temperature Uniformity Test

## **U**

**UBC** – Uniform Building Code  
**UC** – Uncontrolled  
**UL** – Underwriter's Laboratory  
**UMC** – Uniform Mechanical Code  
**UPS** – Uninterruptable Power Supply  
**URS** – User Requirement Specification  
**USP-NF** – The United States Pharmacopeia and The National Formulary

---

## **V**

**VE** – Value Engineering  
**VFDs** – Variable Frequency Drives  
**VGE** – Variable Geometry Nozzle  
**VMP** – Validation Master Plan  
**Vx** – Validation



# Section 13.2

## Predesign Phase

---

### Contents

13.2.0 Introduction

13.2.1 Project Initiation

13.2.2 Data Collection (Pre-design)

13.2.3 Documentation (Pre-design)

13.2.4 APF Contractor Qualifications

13.2.5 Deliverables / Document Review and Approval (Pre-design)

13.2.6 Supplier Qualification

## 13.2.0 Introduction

This section outlines the processes and requirements that must be initiated from the pre-planning level of APF projects. The design must be obtained from concepts, parameters, and data outlined in the following sections of Chapter 13, in addition to those found in [Section 2.1 Research Laboratory Predesign](#). Refer to DRM discipline-specific chapters for additional information.

## 13.2.1 Project Initiation

NIH requires a collaborative, integrated planning and design process that initiates and maintains an Integrated Project Team (IPT), per [Section 1.8.2.1.1 Employ Integrated Design Principles](#), in all stages of a project planning and delivery. The assembly of this IPT is initiated during predesign and continued through the design phase.

In addition to the stakeholders listed within [Section 2.1.0](#), APF IPTs shall include the following additional internal and external stakeholders, as needed:

### Internal Stakeholders:

- NIH Program Chief/Principal/Responsible Individual
- NIH Program Quality Assurance (QA) Office
- Office of Research Facilities (ORF) /Division of Technical Resources (DTR)/ Facility Compliance and Inspection Services (FCIS)
- Clinical Center/ Office of Research Support and Compliance (ORSC)

### External Stakeholders:

- Subject Matter Experts (SMEs)
- Food and Drug Administration (FDA)/ Center for Biologics Evaluation and Research (CBER)
- Food and Drug Administration (FDA)/ Center for Drug Evaluation and Research (CDER)
- Other consultants added during this phase, as needed.

The APF project is initiated by NIH (including the user group and internal stakeholders) who define the Project Program (See [Section 2.1.2](#), and the following APF product related specific requirements):

### A. Objectives:

1. What is the product to be produced?
  - a. Define the product(s) to be produced and the APF General Parameters (See [Exhibit 13.1 APF Questionnaire](#)).
  - b. Define the initial state of control requirements, including facility Critical Process Parameters (CPP) and Critical Quality Attributes (CQA), such as required ISO levels, temperature and humidity to the extent known.
  - c. What are the GxP regulatory parameters which must be satisfied? There may be more than one regulation that applies, which will need to be harmonized.
  - d. What harmonization analyses are required?
  - e. What feasibility studies are required?
  - f. What risk analyses are required?
2. Objectives and acceptance criteria of the proposed facility/work to be performed.

### B. Deliverables:

1. Narrative description of the project and objectives
2. Overview of the program, including major processes, equipment, personnel and material requirements
3. Feasibility and risk analysis studies, as required
4. Project Execution Plan (PEP), to be developed by the project officer (PO)/contracting officer's representative (COR), or PO/COR.

This initiative is led by the user group until the assignment of an NIH PO/COR to the project, and the delegation of certain authorities by the contracting officer (CO) to this individual. The PO/COR is thereafter responsible for leading the project through project initiation,

Pre-design, Design, Construction, and through the Facility Validation phases, to the turnover of the facility to the Users and Facility Management.

**C. End User Roles and Responsibilities:** The End User (hereafter referred to as “user”), including their Institute and Center leadership initiate the APF project. Users shall be involved during the early stages of project definition, design, construction, commissioning, qualification, and validation. The main tasks for the End User include but are not limited to the following:

1. Develop the Statement Of Requirements (SOR), per [Section 13.2.3 Documentation \(Pre-design\)](#).
  - a. Generate a detailed equipment list.
  - b. Support the Integrated Project Team (IPT) in the development of the User Requirement Specifications (URS), based on the SOR, per [Section 13.2.3 Documentation \(Pre-design\)](#). See [Section 1.8.2.1.1 Employ Integrated Design Principles](#).
2. Develop the Validation Master Plan (VMP) to support Qualification and Validation Activities.
  - a. Support the IPT in the development of the Project Validation Master Plan (PVMP), based on the VMP, per [Section 13.16.2 Project Validation Master Plan \(PVMP\)](#).
3. Develop any risk assessments as required to support the SOR, URS, or VMP.
4. Act as the official Point Of Contact (POC) with the FDA for all correspondence and Type-C meetings, as required.
5. Provide review, comments, and sign-off on:
  - a. Statement Of Work (SOW) packages for engaging SME, A/E, construction, and other services, as related to the APF project
  - b. URS
  - c. PVMP
  - d. Basis Of Design (BOD)
  - e. Design Drawings and Specifications

- f. Qualification protocols and testing
6. Approve and respect the “design freeze”.
7. Take ownership of the facility once the project has been completed.

---

## 13.2.2 Data Collection (Pre-design)

Data Collection is the process of assessing product, user, equipment, facility and project needs. The APF have requirements that exceed those outlined in [Section 2.1.2.2 Data Collection](#), [Section Exhibit 2.1 Research Facilities Program Questionnaire](#), and [Section Appendix F: Room Data Sheets](#). These additional needs and requirements shall be captured and documented in the following ways:

**A. Program Questionnaire:** An APF-specific Questionnaire, See [Exhibit 13.1 APF Questionnaire](#), which includes the following sections:

1. General Parameters
2. Program Parameters
3. Regulatory Parameters
4. Standard Operating Procedures
5. Design Parameters
6. Material Flow Parameters
7. Personnel Flow Parameters
8. Safety & Security System Parameters
9. Mechanical System Parameters
10. Electrical System Parameters
11. Facility O&M Parameters

**B. Room Data Sheets (RDS):** APF-specific Room Data Sheet(s) ([Exhibit 13.2 APF Room Data Sheet](#)) are developed during pre-design; then updated at each design submission; and at the end of the design-phase becomes a signed, change controlled document. The RDS are updated and included with the project closeout documents.

**C. Process Diagrams:** Block Flow Diagrams (BFDs) are developed during predesign of new facilities, and are a precursor to Process Flow Diagrams (PFD). BFD are developed by the user group and/or consultants during predesign to describe the relationship and processes of personnel, materials, waste, equipment, and other critical flows. At this stage, the diagrams shall not be architectonic but rather, simple diagrams where the principal functions and equipment are represented by blocks, connected by lines that show the relationships between the blocks. The diagrams are to be accompanied with notes that capture the step by step process flow of the items. These will be refined in later phases; however broad organizational philosophies should be established at this schematic design phase.

1. **Material, Equipment and Personnel Flow**

**(MEPF) Diagrams:** In renovation projects of existing facilities, where the facility or portions of it remain operational during a renovation, the existing MEPFs (which are a part of the URS), shall be maintained as current, including updates of temporary conditions during construction. This may require multiple iterations, as the construction progresses (i.e., showing the flow impacts of temporary barriers, etc.).

**D. GxP Harmonization:** Typically, the GxP environment for a given APF is an amalgam of multiple Statutes, Regulations, Standards, Guidelines, and Codes, some of which may be extra jurisdictional. During predesign, a comprehensive list of all applicable requirements shall be developed, based on product and location of administration. *This report becomes a signed, change controlled document upon acceptance.*

**E. Equipment Schedule:** The compilation of data on all equipment associated with the program, along with its associated requirements, shall be collected and documented via a schedule. Associated equipment requirements shall include measurement, clearances (for operation and service), utility needs, heat output, environmental requirements, etc. as well as, any unique requirements. Specific detailed equipment data (i.e., equipment cut sheet) will be required later, during the design phase, for use in the design of the suite/facility.

## 13.2.3 Documentation (Predesign)

This section describes specific documents which are initiated at the predesign phase of APF projects.

**A. Project Execution Plan (PEP):** The document that establishes the means for executing, controlling, and monitoring the progress of the project. The PEP is developed by the PO/COR, during Predesign, in consultation with the user group and other project stakeholders. The PEP includes the following:

1. Brief narrative description of the scope of the project(s) including design criteria
2. Project approach & execution
  - a. Assigns critical responsibilities, supported by contracts and MOUs, as appropriate (a RACI matrix is typically employed for this task).
  - b. Lists the members of the Integrated Project Team
  - c. Review management: Lists of reviewers and schedule of reviews/documents to be reviewed
  - d. Schedule of approvers per document
  - e. Status reporting plan
  - f. Progress document and data management plan
  - g. Record management plan
  - h. Change management plan
3. Project schedule
4. Project funding
5. Procurement and contracts strategy
6. Scope of services

The PEP shall be reviewed and approved by the User Group, ORSC and DTR/FCIS at the conclusion of predesign and prior to initiating design-phase activities. The PEP is a living document, and shall be maintained and updated as necessary throughout the life cycle of the project. See [Exhibit 13.4 Aseptic Project Execution Plan \(PEP\) Checklist](#).

**B. Statement of Requirements (SOR):** Initiated by the user, clearly, concisely, individually, defines the facility requirements and acceptance criteria. Requirements should be specific, measurable/testable, achievable, and realistic. Requirements that shall be addressed include, but are not limited to:

1. Regulatory requirements, including any GxP harmonization analysis.
2. Operational requirements:
  - a. By whom and how the facility will be used
  - b. PPE requirements
  - c. Type of process
  - d. Process description
  - e. Cleaning procedures and validation
3. Functional requirements:
  - a. What the facility will do
  - b. Functions that the facility must perform
  - c. Level and type of activity
4. Technical requirements for specific systems:
  - a. HVAC
  - b. Electrical
  - c. Computer systems
  - d. Gas systems
  - e. Water
  - f. C<sub>x</sub> & V<sub>x</sub>
  - g. Environmental and equipment monitoring programs
  - h. Interface requirements (i.e., what systems need to be interfaced to, such as sensors to BAS)
  - i. Security requirements
  - j. Maintenance/service accessibility requirements for mechanical equipment in classified space

5. Contamination and cross-contamination issues
6. Lab equipment
7. User's risk assessment

Requirements should include specific acceptable ranges, alert and warning levels.

Any changes to the Statement of Requirements shall be addressed under change control.

**C. User Requirement Specifications (URS):** This is a facility oriented document, based on the user's statement of requirements. Developed during predesign, the URS establishes and documents the user/project requirements as well as the acceptance criteria for an APF. During design and/or preliminary design development, the URS is used by the design engineers, to establish the required functions for each user specified item/requirement.

During predesign, the SOR is created by the end-user. At the beginning of the design phase, the SOR is expanded upon by the A/E design team to create the URS. At the end of design, the URS becomes a signed, change controlled document. The URS shall be updated and maintained current throughout the life cycle of the facility.

The end user shall be responsible for defining the quality critical requirements for the URS. This may include:

1. Temp for the product, process and worker comfort
2. Humidity for product, process, worker comfort, or microbial control
3. Air flow direction and differential pressure (dP) for contamination control, properties of expected airborne contaminants
4. Area classification: airborne particles, including viable and non-viable (i.e. ISO-14644)
5. Clean up (recovery) times from in-use to at-rest (classified spaces)
6. Process containment and exposure sites (high contamination risk areas)
7. Compressed gases
8. High purity water

The URS is the foundational document used in the development of the Basis Of Design (BOD), the Design itself, Design Qualification (DQ), and the Validation Master Plan (VMP), inclusive of Installation Qualification (IQ) for installation, Operational Qualification (OQ) for functionality, and Performance Qualification (PQ) for operability.

NIH requires that a reviewed and approved URS describe the following information prior to the start of construction:

1. **Narrative:** Clear and concise narrative, describing the product, process and project
  - a. Spatial requirements
  - b. Environmental requirements (i.e., EM procedures)
  - c. Security requirements
  - d. Maintenance requirements
  - e. Availability requirements (i.e., 24/7/365)
  - f. Data requirements
  - g. Constraints to be observed
2. **Critical Quality Attributes (CQA):** Attributes that could have a direct impact on the quality of the product being produced or processed, in the space or equipment. Quality attributes may affect the safety and/or efficacy of the product or processes. A quality attribute is a regulatory or compliance related attribute that can be measured/tested and will form the basis for qualification testing. Examples may include, but are not limited to:
  - a. ISO Classification
  - b. Differential Pressure
  - c. Airflow Direction
  - d. Temperature
  - e. Relative Humidity
  - f. Type of PEC
3. **Critical Safety Attributes (CSA):** Factors which could have a direct impact on the safety of the patients, employees, or the community at large. These attributes may also relate to cross-contamination protection of the product. A safety attribute is a regulatory or compliance related attribute that can be measured/tested and will form the basis for qualification testing. Examples may include, but are not limited to:
  - a. Differential Pressure
  - b. Airflow Direction
  - c. Radiation Shielding
  - d. Fire Protection
4. **Business Essential Attributes (BEA):** Attributes that have been identified by site operations, the business unit or the company as being essential, strictly from a business perspective. They define capacity parameters necessary to meet the production plan and will include facility engineering and environmental and personnel safety requirements that are necessary to support the facility. BEA requirements are typically tested during commissioning, but not tested during qualification.
  - a. Output Requirements
  - b. Schedule Requirements
  - c. Budget Requirements
5. **Optional Attributes (OA):** Attributes that have been identified by the team as being desirable, but not essential. Optional attributes may increase the capability or life expectancy of capital equipment, or reduce the manpower required to operate a system. Those optional attributes that remain in the project will be qualified as if they could potentially become CQAs in the future or will be simply commissioned only if they will not.
6. **Process Diagrams:** The URS shall include the BFDs and MERFs at the predesign phase. As the design progresses, the PFDs, P&IDs, and updated MERFs shall be included. Updated PFDs, P&IDs, and MERFs shall be included. During the Operations and Management phase, the PFDs, P&IDs, and MERFs shall be updated as required, and kept current.



At Qualification/Validation of the facility, the URS document shall be reviewed for compliance and a traceability document shall be developed to support the requirements stated in the URS.

## 13.2.4 APF Contractor Qualifications

The qualification of an APF is a regulatory requirement. A systematic qualification process for the individuals involved in the design, construction, commissioning, qualification, and validation of the facility is, therefore, a requirement.

Project-specific qualification requirements shall be included in the SOW for each contract. Not every contractor type, described below, will be required on every project; however, in general, it is recommended that the COR and CO develop appropriate language that stipulates a minimum level of experience in successful projects of similar scale, complexity and regulatory requirements within the prior 5 years, commensurate with the level of risk and complexity of the project being developed.

**A. APF Team:** For all APF projects, the Architects, System Integrators, Engineers, Construction Contractors, Commissioning Agents, Validation Agents, their consultants and subcontractors shall have the required education, training, experience, or any combination thereof, to perform their assigned functions in such a manner as to provide assurance that APF will be built, activated, operated, and maintained in a manner that meets the regulatory requirements for that facility.

**B. A/E Design Team Qualification:** To be deemed qualified, design firms must demonstrate a full working knowledge of process flow integration, cleanroom construction details, materials, and methods. Specifically, the design team must demonstrate a full understanding of the specialized, integrated HVAC design, BAS/EMS surveillance, system and facility qualification, validation, O&M of systems that create and sustain a regulated environment.

Senior design staff of every discipline shall be led by persons having not less than 5 years of experience (within

the prior 10 years), in APF design and/or operation. The design lead shall be a member of ISPE, PDA or BPE and have a demonstrated understanding of aseptic/sterile processing, including workflows, prevention of mix-up and cross-contamination, cleanroom design, cleaning and gowning, qualification and validation.

At least one (1) member of the project design team engaged in the day-to-day project activities shall have demonstrated fluency with (as appropriate to the project):

1. 21 CFR 210, 211, 216, 600, 1271
2. Sections 501-503 of the Federal Food, Drug and Cosmetic Act
3. FDA Guidance for industry:
  - a. “Sterile Products Produced by Aseptic Processing...”
  - b. “Regulation of Human Cells, Tissues...”
  - c. “Homologous Use of Human Cells...”
  - d. USP 795, 797, 800, 823, 1046, 1047

**C. Commissioning Agent/Authority (CxA):** The CxA shall be an independent entity and should be engaged by the end of the schematic design phase. The CxA generally performs design review, development, and execution of the Cx Plan.

**D. CxA Qualification:** To be deemed qualified, the CxA shall:

1. Be independent of the project design and/or construction team.
2. At least one (1) member of the CxA team engaged in the day-to-day project activities shall have a minimum of 3-5+ years of experience in commissioning of APF HVAC systems, utility distribution systems, building automation systems, and troubleshooting of systems.
3. Demonstrate significant relevant commissioning experience, including technical and management expertise on APF projects of similar scope, size, and type.
4. Bring a total building commissioning perspective to the project.

5. Have field startup experience, controls and understanding of multiple sequences of operations scenarios within an APF.
6. Demonstrate strengths in HVAC, Utility Distribution Systems, Building Automation Systems, and troubleshooting of interconnected systems within an APF.
7. Have documented commissioning process experience on projects of similar scope as the APF project that's being commissioned. The experience must extend from early in the design phase through post-occupancy.
8. Mechanical Engineer or other technical engineering degree is preferred.
9. CxA and/or LEED certification is beneficial.

**E. Commissioning, Qualification, Validation (CQV)**

**Authority:** The CQV shall be an independent entity and shall meet the minimum requirements for Cx and Vx.

**F. GMP Project Execution Manager (PEM):** A contractor, generally engaged during the predesign phase, unaffiliated with the design or construction entities engaged in the project. A PEM is similar to an Owner's Representative and supports the PO/COR. The PEM shall assist the COR in overseeing the project, from inception to turnover. The PEM is differentiated from a Certified Quality Manager (CQM) in their enhanced role in strategic planning, and coordination between the various stakeholders within the project, as well as advising the PO/COR on APF-specific requirements. The PEM shall be responsible for:

1. Creating, maintaining schedule, including coordination between contractors.
2. Ensuring project documents are created and maintained per Good Documentation Practices (GDP) and in a timely manner.
3. Maintain the project Change Management process.
4. Review and comment on all project documents for completeness, correctness, fitness for intended purpose, and coordination.
5. Perform on-site inspections for the quality of workmanship and materials, conformity with

plans and specifications, on-site safety, project schedule vs. progress.

6. Manage and document all project meetings.
7. Witness and document critical work being performed, including coordinating testing by the user group, CxA, QVxA, etc.
8. Other functions as identified by the COR in the PEM's SOW.

**G. PEM Qualification:** To be deemed qualified, the PEM shall:

1. Be able to demonstrate their familiarity with APF projects and the project's GxP requirements.
2. Shall have a combination of experience in the construction, activation and operation of APFs, and education training as deemed at least minimal for the tasks related to the specific project.
3. Should have a relevant master's or professional degree; Project Management Institute (PMI) certified as a Project Management Professional (PMP), minimum; Program Management Professional (PgMP) and/or PMI Risk Management Professional (PMI-RMP) preferred. A Senior Level FAC-P/PM shall be considered equivalent.

**H. IDIQ Design/Build Contractors:** The CO/COR shall stipulate in the SOW language that the teaming relationships conform to the A/E and Construction Contractor requirements of this section. It is not the intent to bar an inadequate IDIQ pool but shall require that the work is performed by qualified subcontractors. There is no waiver of the minimum self-performance requirement of the IDIQ-holder unless stipulated, in writing, by the CO.

**I. O&M Contractor(s):** Contractor shall be adequately trained in all relevant practices for proper clean-room operation, maintenance, and in-process control. Training shall be documented and maintained as current. The responsibility for providing training shall be clearly defined in the SOW.

**J. Qualification/Validation Authority (QVxA):** The Qualification/Validation Authority should be engaged by the end of the schematic design phase.

**K. QVxA Qualification:** To be deemed qualified, the QVxA must demonstrate:

1. Significant relevant qualification/validation experience, including technical and management expertise on APF projects of similar scope, size, and type.
2. The QVxA performing the day to day work on the project must have documented commissioning experience on projects with a similar scope of work, specifically cleanroom certification tests in accordance with ISO 14644.
3. The QVxA shall have documented experience with performing IOPQ on facility systems including HVAC, compressed gases, and water systems. In addition, where applicable, QVxA shall have experience in PQ of environmental monitoring, and IOPQ's of various user equipment.

---

### 13.2.5 Deliverables / Document Review and Approval (Predesign)

There are many documents and processes that are specific to APF projects. Some of these documents are subject to validation (approved by signature from appropriate parties), and some are subject to review by parties above and beyond those specified in [Section 1.5.3.3 NIH Technical Review Staff](#). [Table 13.2.5](#), below, provides a typical framework for the documents associated with this phase, although there will be some facility and project specific variations, this table should be considered as general and informative, but not exhaustive or inclusive of the document requirements of a specific project. Those specific requirements should be developed during this phase and documented in the PEP.

### 13.2.6 Supplier Qualification

Supplier Qualification is a risk assessment tool within the quality system that establishes the minimum requirements to identify, select, approve and qualify suppliers of all materials and services utilized in the design, construction, validation, operations and maintenance of the APFs. The supplier of the goods or services must adequately document that the goods and services meet or exceed the minimum criteria that have been established and are fit for use for the described purpose. Audits may be a helpful tool to establish the legality, suitability and competence of the contractor to provide what has been contracted for. Third-party laboratory testing may be necessary to establish conformance to the requirements of the contract and applicable regulations.

Supplier qualification should include, but is generally a subset of the following for non-critical production materials, construction and operations materials, and services:

1. Review of the contract specification language
2. The supplier selection process
3. Review of product produced, its components, and documentation
4. Review of services to be provided, particularly the qualifications and training documentation of the personnel performing the work.
5. Sample evaluation
6. Due diligence process
7. Quality Assurance of all suppliers
8. Change control and production assessment as necessary
9. Supply chain of custody/security
10. Ongoing monitoring and evaluation

**Table 13.2.5 APF Document Review and Approval (Predesign)**

Document	Signed	Controlled	PO/COR	Per DRM Section 1.5.3.3	FCIS	ORSC	DFOM	NIH Program (User)	User QA	External Regulatory Agencies
Project Execution Plan			IRS		R	R		R	R	
Statement of Requirements (SOR)	•		R		R	RS		IRS	RS	
GxP Harmonization Report	•	•	R	R	RS	RS		IRS	RS	R
Feasibility Study Report(s)	•		IRS	R	RS	RS		RS	RS	R
Program Questionnaire			IRS	R	R	R		R	R	
User Requirement Specifications (URS)	•	•	R	R	RS	RS		IRS	RS	R
Room Data Sheets (RDS)			IRS	R	R	R		R	R	R
Process Diagrams: Block Flow Diagrams (BFD)			R	R	RS	R		IR	R	R
Equipment Schedule			R	R	R	R		IR	R	

*I* Initiated By

*R* Reviewer

*S* Signatory

*Note: Unless indicated otherwise, PO/COR is responsible for the management of the above document(s).*

# Section 13.3

## Design Phase

---

### Contents

13.3.0 Introduction

13.3.1 Schematic Design (SD)

13.3.2 Design Development (DD)

13.3.3 APF Design Considerations

13.3.4 Common APF Design Elements

13.3.5 Design Review and Design Qualification

13.3.6 Value Engineering (VE) and Sustainable Design Requirements

13.3.7 Commissioning and Validation Activities (Design)

13.3.8 Document Change Control

13.3.9 SOP for Construction

13.3.10 Non-Inspection FDA Meetings

13.3.11 Deliverables (Design)

13.3.12 Document Review and Approval (Design)

## 13.3.0 Introduction

This section describes the additional design requirements associated with the transition from predesign, through the execution of design phase activities, inclusive of schematic design, design development, and construction document sub-phases. The design shall conform to Good Engineering Practice.

### 13.3.1 Schematic Design (SD)

**A. Feasibility Study:** A feasibility study is conducted to explore the viability of an idea and developed during the design. This study is an evaluation and analysis of a proposed project to determine:

1. Is the project technically feasible?
2. What are the facility risks for executing the project?
3. Does the proposed project fulfil the GxP requirements?
4. What would be the risks for operating the facility, if designed, constructed and operated as proposed?
5. Is the project feasible to be designed, constructed, commissioned, validated, operated and maintained as proposed, within the limitations of current schedule and budget?

The objective of the feasibility study is to provide a filtering of needs in a structured way without spending too much time or money on the project's viability/feasibility.

Options to explore include:

1. Site selection
2. Constructability assessment
3. Operations and maintainability review
4. Cost and schedule assessments
5. Objectives and acceptance criteria of the work (if not developed during predesign)

The list of conceptual design options should be specified to give the project team boundaries and to help define the time and effort required for the project.

### 13.3.2 Design Development (DD)

**A. Data Collection (Design):** The APF Data Collection requirement includes supplementary requirements to those found in [Exhibit 2.1 Research Facilities Program Questionnaire](#). During the Design phase, initial data collection will be expanded, confirmed, modified, or redeveloped.

1. **Program Questionnaire:** Originally developed during Predesign, updated as required.
2. **Room Data Sheets (RDS):** Originally developed during predesign and, updated at each design submission. At the end of the design phase, the RDS becomes a signed, change controlled document. The RDS are updated and included in the project closeout documents.
3. **Process Diagrams:** Originally developed during Predesign, as simple Block Flow Diagrams (BFD), these shall be updated and expanded. An analysis of components, drug product containers, material, personnel, product and waste flows, are critical for detecting and minimizing crossed-paths to prevent contamination or mix-ups during operation. An approach for the smooth, efficient and safe flow of materials, waste, personnel, and product shall be developed at minimum, at the individual APF site; however, it may also be necessary to study these flows in a room, suite, facility, building level, wing, and/or whole building level.
4. **Process Flow Diagrams (PFDs):** These have additional detail, and narrative, and are overlaid upon the facility floorplan (showing walls, doors, windows, equipment, and furniture in sufficient detail to provide full context to the process being illustrated). The diagrams shall be accompanied by a narrative explaining the scientific work/process being illustrated. The following minimum PFDs are generally



required, but may vary depending on the facility:

- a. Scientific Workflow
- b. (Raw) Material Flows
- c. Waste Material Flows
- d. Finished Product Flow
- e. Contamination Sources and Mitigation: Cross-Contamination Prevention Diagram
- f. Personnel Flows
- g. PPE Donning/Doffing Diagram
- h. Equipment Flows
- i. Basic Airflow Diagram including Critical Control Elements
- j. Room Classification Map (ISO/CNC/NC)
- k. Pressure and Airflow Direction Map
- l. Airlock Arrangements
- m. Access Control Diagram

The PFDs are updated and expanded throughout the design phase. At the end of the design phase, PFDs become signed, change controlled documents, maintained throughout the life cycle of the facility.

5. **Piping and Instrumentation Diagrams (P&ID):** These are a comprehensive diagram which builds upon and coordinates with PFDs to describe systems and components in detail. Each PFD may require multiple P&IDs, as only one operation is depicted on each diagram. At the end of the design phase, P&IDs become signed, change controlled documents, maintained throughout the life cycle of the facility.
6. **GxP Harmonization:** Originally developed during Predesign, updated as required.
7. **Quality Risk Management (QRM) Report:** QRM is a robust, structured process for:
  - a. Risk Assessment
  - b. Risk Control

- c. Communication
- d. Management of risks to the product being produced, spanning the life cycle of the facility.

A formalized risk assessment shall be conducted to identify and mitigate risks to the product in accordance with ICH Q9, “Quality Risk Management,” using appropriate procedures, facilitators, and structured tools. The assessment shall be limited to cGMP compliance risks associated with the facility design/construction, including flow of personnel and material, prevention of mix up, contamination mitigation, risks of aerosolization, handling of hazardous material, determination of ISO classification, engineering vs. administrative controls, environmental monitoring, flood damage, pest control, loss of utilities, loss of differential pressure, redundancy requirements, and appropriate preventative maintenance measures. Every step in the processes shall be reviewed for susceptibility to contamination and cross-contamination.

Various methodologies are available, but the one selected for the project must support a scientific and practical approach to decision-making. The selected methodology shall provide documented, transparent, and reproducible methods to accomplish steps of the quality risk management process based on current knowledge about assessing the probability, severity, and, sometimes, detectability of the risk. [Figure 13.3.2](#) describes a typical structure but is not reflective of all projects or APFs.

One of the most frequently deployed methodologies for NIH APFs is Failure Mode Effects Analysis (FMEA). Under this methodology, potential failure modes for processes and likely effect on outcomes and/or product performance is evaluated; then risk reduction can be used to mitigate the potential failures. FMEA can be used to prioritize risks, monitor the effectiveness of the mitigation strategy, and be used as a basis for further analysis, changes to SOP, or additional facility modifications.

The QRM shall organize the various Risk Assessments into a single, cohesive report.

8. **Equipment Schedule:** Originally developed during Predesign, will be updated as required.

**Figure 13.3.2 Risk Analysis Diagram** (From FDA ICH Q9, Figure 1: Overview of a typical quality risk management process)

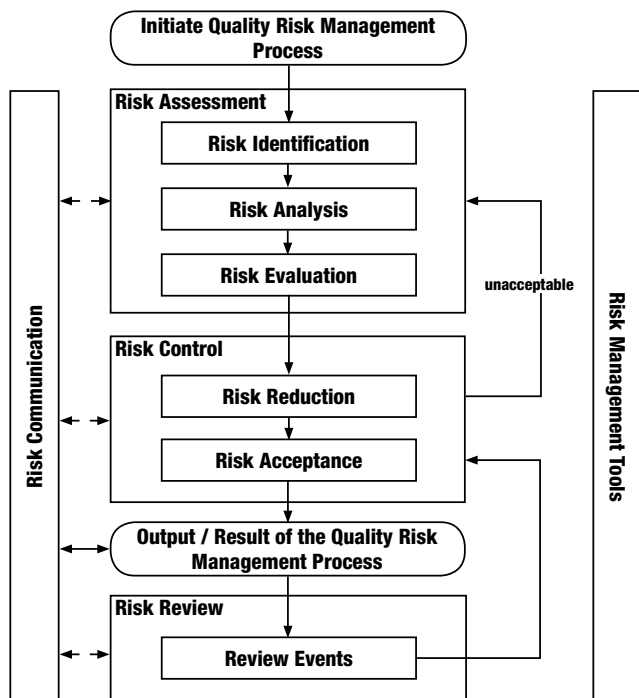

Decision nodes are not shown in the diagram above because decisions can occur at any point in the process. These decisions might be to return to the previous step and seek further information, to adjust the risk models or even to terminate the risk management process based upon information that supports such a decision. Note: “unacceptable” in the flowchart does not only refer to statutory, legislative, or regulatory requirements but also to indicate that the risk assessment process should be revisited.

**B. Basis Of Design (BOD):** The BOD serves to document the parameters of the project, the design intent, and includes narratives, which explain and document all important requirements and decisions made during the design process. APF projects shall have a BOD, developed during the Design phase and progressively updated during design submissions. The BOD becomes a signed, change controlled document upon acceptance of the final design submission. The BOD shall

be maintained throughout the life cycle of the project and any subsequent changes shall be under change control. This is in contrast with the URS, which shall be updated throughout the life of the facility.

The BOD establishes the basis for a detailed design and shall be well coordinated with the URS. In addition to the BOD report requirements found in [Appendix E: A/E Submission Requirements](#), APF BODs should include the following additional information, but may vary depending on project-specific requirements, as determined by the COR:

1. System Design Narratives: Concepts on which systems are based, rationale and methodologies, and how BOD satisfies the URS.
2. System Equipment BOD Products (i.e. critical plumbing utilities, etc.)
3. System Level Risk Assessment:
  - a. AHU Zone Map
  - b. HVAC Control Philosophy
  - c. Plumbing Diagram
  - d. Electrical Diagram
  - e. Fire Protection Diagram
  - f. Low-Voltage Diagram
  - g. Preliminary Sections of Critical Areas

**C. Validation, Commissioning, and Qualification Documents:** As described in [Section 13.16 Facility Commissioning, Qualification, and Validation Phase](#).

### 13.3.3 APF Design Considerations

In addition to organizational, operational, infrastructure issues encountered in the typical design process, additional factors, not limited to the following, shall be taken into consideration during APF design.

**A. Multiple Product Production:** A critical design decision in the planning of an APF is whether multiple products or a single product will be produced in the facility.

If multiple products are to be produced, will this production be campaigned or be concurrent?

1. **Campaigned Production:** Campaigned production is a production strategy which is characterized by a facility, suite, or room making a single product at a time, followed by a robust cleaning and, if required, equipment reconfiguration, prior to commencing production of the next sequential product. A strong Environmental Monitoring (EM) and Quality program are required to ensure adequate line clearance and cleaning efficacy have been met. Generally, this is the most restrictive multi-product strategy, by SOP, but carries the least risk. A risk analysis is required to substantiate the decisions associated with campaigned production.
2. **Concurrent Production:** Concurrent production is a production strategy which is characterized by suite(s), or room(s), each making different products at a time. SOPs are established for cross-contamination and mix-up risk mitigation and enhanced Environmental Monitoring (EM). This strategy carries a high demand on the HVAC and other facility systems to protect the products. A risk analysis is required to substantiate the decisions associated with concurrent production. The risk analysis should be iterative, in order to assure that identified mitigations are implemented and to verify that new risks have not been created by the design or construction.

**B. Personal Protective Equipment (PPE) Requirements:** Not later than during Schematic Design, a clear understanding of the gowning requirements and associated space needs for shelving, bench, full-length mirrors, waste containers, etc.

**C. Cleaning Protocols:** Not later than during Schematic Design, a clear understanding of the cleaning protocols and chemicals used to ensure selection of appropriate finish materials.

**D. Environmental Monitoring System (EMS) and Building Management System (BMS):** Not later than during Design Development, a clear understanding of the Environmental Monitoring System (EMS) and Building Management System (BMS) systems, including sensor compatibility, sensor co-location, and calibration strategy.

**E. Mechanical, Electrical, Plumbing, and Fire Protection) MEP-FP Design Strategy:** Equipment requiring servicing, piping, cabling, etc. should be minimized within classified spaces to avoid problems with adequate cleaning and mitigate risks associated with leakage and the disruptions caused by the entrance of DFOM for scheduled and unscheduled maintenance activities.

**F. Modular Unit Systems (MUS):** APF modular unit systems include both road-trailer-mounted pre-engineered and off-trailer variants. In both cases, the system manufacturer will assume the roles and responsibility of designer and builder. The review process for modular systems is the same as for conventional construction means and methods. APF that are developed via these methodologies are subject to Factory Acceptance Testing (FAT) and Site Acceptance Testing (SAT) following installation.

MUS facilities shall be modular, to facilitate future expansion or reconfiguration. To the extent practicable, they should be deployment ready when they leave the factory. Additionally, an APF MUS should have the following minimum characteristics:

1. **Minimum Structural Capacities & Requirements:** See [Section 13.7](#).
2. **Minimum HVAC Capacities & Requirements:** Refer to [Chapter 6](#) for general MEP requirements and [Section 13.8](#) for APF-specific HVAC requirements.
3. **Supplemental MUS APF MEP Requirements:**
  - a. MUS shall be capable of sustaining the URS indoor design conditions on a 24/7 basis.
  - b. Where practicable, the MUS shall be connected to the campus chilled water loop.
  - c. Where campus chilled water is not practical, n+1 redundant and dedicated air-cooled chillers and pumps shall be provided. AHU and exhaust fans shall be redundant.
  - d. Where campus steam is not practical, n+1 redundant and dedicated boilers and pumps shall be provided. Gas boilers are preferred over electric.

- e. MUS mechanical systems shall be capable of tying into the campus BAS system for monitoring, alarms, trend analysis and assist during maintenance and troubleshooting. This includes both source (i.e., chillers, pumps, etc.) and distribution equipment, devices and sensors.
  - f. All sinks shall be tied-into the campus domestic water and sanitary waste loop (i.e., no tanks). If this tie-in requires disinfection or neutralization prior to discharge, that capacity will be integral to the MUS.
  - g. Eyewashes shall be mobile units with sealed water reservoirs in lieu of standard tank-type (which require chemical maintenance), or plumbed units, which require regular testing.
  - h. Compressed gases such as Nitrogen (N<sub>2</sub>), Carbon Dioxide (CO<sub>2</sub>), Oxygen (O<sub>2</sub>) and compressed air, if required, will be provided via cylinder gases supplied from automatic cylinder change over manifolds. The cylinders shall be located in a ventilated and heated enclosure with proper access for replacing the cylinders.
  - i. AHUs, valves, dampers, terminal units, heaters, controls, etc. shall be located within the MUS, in areas that allow for serviceability from outside the cleanroom spaces. Provide adequate access to mechanical equipment to minimize downtime during repair. Proper service clearances shall be provided to and around equipment.
  - j. Main equipment (i.e., exhaust fan, pumps).
  - k. The MUS shall be configured to supply its emergency/standby power if required, to conform to the URS.
  - l. The inside and outside of the MUS shall be configured for digital video cameras and equipped with digital video recorder(s) (DVR).
4. **Other Supplemental Minimum Requirements:**
- a. Minimum clear height should be not less than 2.4 m (8 ft.).
  - b. MUS design shall include all floor level change and weather enclosure requirements.
  - c. MUS shall not be installed in direct soil contact. The MUS should be installed on a prepared concrete slab, extending a minimum 1.5 m (5 ft.) beyond the face of the MUS in all directions, and/or elevated not less than 914 mm (3 ft.) above adjacent grade – which much be de-sodded, covered with washed 51 mm (2 in.) or larger gravel, over weed stopping geotextile fabric.
  - d. Road trailer-type MUS shall be based on gooseneck/King-Pin chassis (i.e., semi-trailer structure).
  - e. Non-Road trailer-type MUS shall be based on standard-size sea crates or similar structures.
  - f. MUS shall be designed to facilitate gaseous decontamination.
  - g. MUS shall be designed and tested to meet CETA CAG-003-2006 Certification Guide for Sterile Compounding Facilities.
  - h. All work surfaces shall be stainless steel. All shelving shall be open wire-type to promote observation and airflow.
  - i. The manufacturer shall provide full documentation support for third-party IQ/OQ/PQ validation activities.
  - j. The manufacturer shall provide video recorded operator and maintenance training, along with full supporting documents and manuals.
  - k. A dedicated EMS monitoring system shall be provided for monitoring critical parameters such as temperature, humidity and differential pressure as described in [Section 13.16 Facility Commissioning, Qualification, and Validation Phase](#).

**G. Additional APF Design Considerations:**

1. Exterior windows should be minimized, but where provided shall be detailed to limit the possibility of moisture migration.
2. Provide the location and detailing of emergency showers, eyewashes, and other safety devices to minimize their contribution to the bioburden of the facility especially in the ISO classified spaces.
3. Define the level of required physical security/access control.
4. Door interlocks and red/green light indicator lamps (physical, procedural, or both).
5. Modular wall and ceiling panel systems vs. traditional epoxy-coated gypsum wallboard construction.

---

### 13.3.4 Common APF Design Elements

ISO levels of classification are based on air purity, and the number of airborne particulate sized ( $\geq 0.5 \mu\text{m}$ ,  $\geq 5 \mu\text{m}$ ) which are measured “in operation” as well as, “at-rest” state. Engineering controls monitor parameters such as temperature and humidity level due to their potential impact on particle generation and microorganism proliferation.

**A. Space Classifications:** The progression of space classifications generally includes, in order from least to most clean:

1. **Not Classified (NC):** Areas where the HVAC systems are present, but no claim is made or qualified for the control of particulates, temperature or humidity.
2. **Controlled Not Classified (CNC):** Areas where HVAC systems are specifically designed to reduce airborne contaminants below the level of the ambient environment and both temperature and Relative Humidity (RH) are controlled more tightly than in the ambient environment although there is no monitoring of airborne

particulate size. Qualification is common.

No claim is made or qualified for the specific control of particulate. Typical systems will have heating, cooling and filtration meeting MERV 13 or better.

3. **Controlled Not Classified with Local Monitoring (CNC+):** These areas are typically qualified to meet ISO 8 requirements at rest only, to control temperature and humidity within a specified band. These areas are generally aligned with PIC/S designation "Grade D."
4. **Anteroom (APF Suite):** See [Section 13.5.7 Anteroom Requirements](#). Anterooms/airlocks shall be provided to allow personnel to enter the APF suite and proceed through multiple stages of gowning protocols, as appropriate, for the level of risk.

Airlocks at the entry and exit to the facility, for personnel gowning and de-gowning, provide buffers between different ISO classifications. Entry airlocks shall be the same ISO classification as the aseptic processing room they serve, while return airlocks may be lower. Anteroom/airlocks provide a transition area that ensures that pressure relationships are maintained during normal disturbances to the HVAC (such as door openings), and mitigates the impact of large disturbances in the HVAC system, such as power outages, or equipment failures. An airlock shall be required between lower classified spaces and ISO 8 space.

5. **ISO 8:** A classified space that satisfies U.S. FDA requirements for ISO 8 classification measured via airborne  $0.5\mu\text{m}$  particulate in the "in-operation" state, as well as EMA and PIC/S requirements to meet ISO 8 measured via airborne  $0.5\mu\text{m}$  and  $5.0\mu\text{m}$  particulate in the "in-operation" state and meet ISO 7 measured via airborne  $0.5\mu\text{m}$  and  $5.0\mu\text{m}$  particulate in the "at-rest" state.
6. **Anteroom (ISO 7):** An anteroom is required for a transition between ISO 8 and ISO 7 spaces. The air quality within these anterooms may need to meet ISO 7 or 8 requirements, depending on airflow. See [Section 13.5.7 Anteroom Requirements](#).



7. **ISO 7:** A classified space that satisfies U.S. FDA requirements for ISO 7 classification measured via airborne 0.5µm particulate in the "in-operation" state, as well as European Medicine Agency (EMA) and Pharmaceutical Inspection Cooperation/Scheme (PIC/S) requirements to meet ISO 7 measured via airborne 0.5µm and 5.0µm particulate in the "in-operation" state and meet ISO 5 measured via airborne 0.5µm and 5.0µm particulate in the "at-rest" state.
8. **Anteroom (ISO 5):** An anteroom is required for a transition between ISO 7 and ISO 5 spaces, although typically ISO 5 is only provided within PECs. The air quality within these anterooms may need to meet ISO 5 or 7 requirements, depending on airflow. See [Section 13.5.7 Anteroom Requirements](#).
9. **ISO 5:** A classified space that satisfies U.S. FDA requirements for ISO 5 classification, measured via airborne 0.5 µm particulate in the "in-operation" state, as well as EMA and PIC/S requirements to meet ISO 5 measured via airborne 0.5 µm particulate and ISO 4.8 measured via airborne 5.0 µm particulate in the "in-operation" and "at-rest" states. An ISO 5 environment is typically achieved in a Primary Engineering Control (PEC), while less restrictive environments are generally created and maintained by the design, mechanical systems, and procedures followed by staff. All open process tissue work is performed in an ISO 5 environment.

In addition to the above design considerations, which impact the organization and relationship of spaces within the APF, there are certain design elements which are generally consistent across various types of APF. See [Section 13.4 Biologics Facilities](#) for design elements that are specific to Biologics Facilities and [Section 13.5 Compounding Pharmacy Facilities](#) for design elements that are specific to Pharmacy Facilities. Other common APF design elements include:

**B. Equipment:** All equipment and furniture shall be non-permeable, non-shedding, cleanable and resistant to regular exposure to cleaning chemicals and processes without degradation. All surfaces should be "smooth, impervious, free from cracks and crevices, and non-shedding." Equipment and furniture installed in an APF must be specifically designed, fabricated, and marketed

for use in 'Cleanroom' environments. Some typical cGMP equipment includes:

1. **Biological Safety Cabinets (BSCs):** BSCs are among the most important equipment in the GMP facility. BSC's provide open front and inward and downward HEPA filtered air HEPA exhaust. The overall design shall enable one or more BSCs to remain in use should the other(s) become inoperable. The appropriate selection of BSC type shall be substantiated via the QRM (Risk Assessment) process.

Most Aseptic Processing Room BSCs will be Class II Type A2. Access to these rooms shall be through an ISO 7 anteroom. The overall design shall enable one or more BSCs to remain in use should the other(s) become inoperable. Class II Type B2 (ducted exhaust) BSCs are generally unnecessary for manufacturing Cell Therapy products but are generally required for the safe manufacture of products in USP <797> facilities.

2. **Centrifuges:** These are typically located in equipment or Tissue Culture Rooms.
3. **Incubators:** Incubators are located in Tissue Culture Rooms and will be used for the product currently in production in that room at that time. CO<sub>2</sub> will be required.
4. **Laminar Air Flow Workstation (LAFW):** LAFWs provide ISO 5 unidirectional environment with horizontal HEPA air flowing from the back of the LAFW toward the open front. Vertical LAFWs shall not be used.
5. **Pass Throughs:** See [Section 13.6.5 Wall Accessories](#).
6. **Refrigerators and Freezers:** Refrigerators and freezers shall be used for storage of intermediate and long-term products. These will be mechanical refrigerators and freezers including cryo-freezers. Under counter refrigerators can be used for daily storage. Controlled rate freezers will be housed in clean freezer rooms.

**C. Cross-Contamination Prevention:** A system of airlocks and pass through(s), designed to provide separation of spaces, buffer between HVAC zones and,



provide areas for cleaning and gowning/de-gowning between areas of different classification or contamination risk. These elements, including personnel and cleaning flows, assist in addressing the risk of product cross-contamination

**D. Primary Engineering Controls (PEC):** The basic design for the compounding space shall consist of an ISO Class 5 Primary Engineering Control (PEC) located within an ISO Class 7 room, such as a buffer, intravenous (IV), or chemotherapy (chemo) room. Access to these rooms shall be through an ISO Class 7 anteroom. Proper placement of PEC is critical to ensuring an ISO 5 environment for compounding.

PECs shall be located out of traffic patterns and away from circulating air currents. Both Laminar Air Flow Workstations (LAFW) and BSCs may be used.

**E. Secondary Engineering Controls (SEC):** In an APF facility, the environments leading to the ISO 5 Primary Engineering Control (PEC) are referred to as the “Secondary Engineering Controls.” Under USP terminology, these are referred to as “Buffer Areas.” These rooms have specific air supply, exhaust, differential pressure, airflow direction, temperature, relative humidity and other requirements. These environmental performance requirements will be listed in the URS. The SEC areas must maintain their ISO class under dynamic working conditions.

**F. Controlled Not-Classified (CNC):** CNC areas are those within the aseptic manufacturing facility which are designed to support the manufacturing process, but which do not require the level of control and monitoring required to maintain a specific ISO Classification. A CNC area must be cleanable, access-controlled, and supplied with HEPA filtered air (typically systems will have heating, cooling and filtration meeting MERV-13 or better), where the HVAC systems are specifically designed to reduce airborne contaminants below the level of the ambient environment and both temperature and Relative Humidity (RH) are controlled more tightly than in the ambient environment. Qualification is common. No claim is made or qualified for the specific control of particulates.

**G. Gowning and Changing Rooms:** These may be in a dedicated room or an area of a multipurpose room, and provide space for donning and doffing PPE. There should be a transition area that ensures appropriate

pressure relationships are maintained during normal conditions and during large disturbances in the HVAC system. The ante area further segregates the aseptic processing rooms and other cleanrooms from less-clean areas of the facility. The ante area should have a rectilinear footprint, without offsets for achieving uniformity of airflow.

During the predesign phase, criteria should be established for the following (refined as required during the design phase):

1. Understand and define the number of people at one time in use and the maximum capacity per code.
2. Gowning (on and off) procedure
3. Frequency of replacement, storage, and disposal of needed equipment
4. Disposable vs. cleanable for multi-use PPE
5. Hand hygiene equipment
6. Instructional aids

Sufficient space for donning/doffing PPE is essential, with attention given to unidirectional, non-crossing movement. A generic process flow for this action follows:

**Entry:**

1. Enter controlled area suite
2. Walk-off adhesive mat
3. Use lockers for securing personal property
4. Use shoe covers, or rack for housing cleanroom shoes.
5. Use hands-free hand hygiene station
6. Collect PPE, as needed:
  - a. Under-glove or glove dispenser
  - b. Medical face mask and beard cover (as required) dispenser
  - c. Non-shedding hood/headcover dispenser
  - d. Non-shedding coverall PPE dispenser
  - e. Bootie/shoe cover dispenser

7. Don PPE
8. Use waste receptacle for PPE wrappings
9. Step over Line of demarcation (LOD) when donning shoe covers/cleanroom shoes
10. Use an inspection mirror with poster of properly donned PPE, with adjustment, as required
11. Collect additional PPE, as needed:
  - a. Safety glasses dispenser
  - b. Over-glove dispenser
12. Don additional PPE
13. Use waste receptacle for PPE wrappings
14. Use adhesive walk-off adhesive mat
15. Enter aseptic area

**Exit:**

1. Use adhesive walk off mat
2. Exit aseptic processing area
3. Use waste receptacle for disposable PPE
4. Return to start to stow cleanroom shoes
5. Retrieve personal property
6. Leave controlled area

The site-specific donning and doffing process shall be codified by users, into an SOP, which will stipulate training and certification requirements for operators, and other NIH staff who frequent the facility (i.e., DFOM, DTR/FCIS, etc.). Provisions for training infrequent site visitors should be incorporated into the SOP. Site-specific procedures may change due to modifications in programs, regulations, and availability of appropriate PPE. The facility should be large enough to accommodate such changes. Provide waste receptacle wherever PPE is removed from packaging. Provide ergonomic lean-rails, benches, etc., to facilitate safely donning/doffing PPE.

During construction, the clean build requirements require the contractor to develop, per user approval, a PPE entry/exit plan, commensurate with the work being

performed. To the extent practicable, it should utilize the existing gowning and changing areas.

**H. Equipment Rooms:** These are areas within the aseptic manufacturing facility which support the manufacturing process. The program use of the space will determine whether the equipment can be housed in CNC (typical) or requires higher ISO classification. Some equipment rooms may require environmental containment as well.

The type and number of required support equipment is program-driven and may include incubators, controlled rate and low/ultra-low temperature freezers, centrifuges, shakers, bead baths, autoclaves, and other equipment for specialized functions requiring isolation, containment, or separation. Sufficient size must be programmed for equipment rooms to allow for air circulation around equipment and for adequate cleaning between and behind.

**I. Freezer Room:** Freezer rooms are a specific, and common type of APF equipment room. Cell Therapy manufacturing facilities generally use liquid nitrogen (LN<sub>2</sub>) storage freezers and ultralow temperature (-80°C) mechanical freezers. In addition to storage freezers, programmable (controlled-rate) freezers are located in clean freezer rooms. Liquid nitrogen freezers (storage tanks) and mechanical freezers shall be on emergency power and will require IT drops.

Liquid nitrogen should be supplied from an external bulk supply tank or from locally stored supply liquid cylinders. Liquid nitrogen supply cylinders should be located to facilitate change-out without entering classified space. Where necessary to accomplish this safely, the cryogenic supply cylinders shall be connected to the LN<sub>2</sub> use points via a DRM compliant piping system, which shall be vacuum jacketed. Provided Oxygen depletion monitors tied to BAS in LN<sub>2</sub> freezer rooms.

**J. Quality Control (QC) Laboratory:** The QC lab contains flow cytometry and other assay testing equipment and associated computers and is located outside the classified areas, so the technologist does not need to be fully-gowned. Consideration shall be given to high-density storage systems in storage rooms.

**K. Supply Rooms:** Supply rooms may be designated as “dirty” for the receiving of quarantined materials, breaking down and reducing packaging, etc., or “clean”

for receiving materials released for use in the facility. Clean supply rooms shall be constructed to meet the requirements of a classified space, as appropriate.

**L. Housekeeping Room:** Housekeeping room (or Janitor's Closet) may be used to store cleaning equipment and supplies, specific to the APF to which it is associated. It is permissible to centrally house equipment and supplies and deploy to numerous separate APFs, only under approved SOP, due to contamination risks. Access to this space (frequency, timing, and personnel) shall be clearly defined by the program during programming level, to ensure that the design addresses any need for mechanical controls. A janitor's closet may be classified as "clean" or "dirty" depending on the location and function. See [Section 2.4.5.5 Janitor's Closets](#), [Section 6.1.13.3 Relative Room Pressurization within Administrative Areas](#), [Section 6.1.14 Air Distribution Systems](#), and [Section 8.2.11 Janitor Sinks/Mop Sinks/Janitor Closets](#).

1. **Clean Janitor's Closet:** Typically located within the classified zone of the APF. A sink may be provided in the Clean Janitor's Closet for the preparation of site mixed/diluted cleaning agents but is not recommended due to environmental monitoring concerns.
2. **Dirty Janitor's Closet:** Typically located in non-classified zones of the APF. A sink and/or floor drain may be provided for the approved disposal of waste cleaning solutions. The traps for these drains must be part of a trap maintenance program to control biological growth and contamination.

**M. Administrative Areas:** Administrative areas may include an office area for cell processing staff and any other office areas required for records, reports, accounting activities, and patient storage.

**N. Mechanical Rooms:** The design of mechanical support spaces for cGMP APFs require a fundamental shift in the typical approach which defers much of the final placement and alignment of components. Because of the high frequency of calibration, certification, and verification, a higher level of intentionality to facilitate this ongoing work is required. The designer should strive to make the systems as simple as possible, with gauges, sensors, valves and other control points organized to promote this higher level of service. Access ways and

"swim lanes" must be planned and maintained.

APF mechanical rooms shall be designed to be brightly lit, painted, and have waterproof, seamless, durable floors with 152 mm (6 in.) integral base. Floors of mechanical rooms shall be designed to contain leaks. Penetrations through the floor shall be protected, via sealed raised curbs and sleeves. Housekeeping pads shall be provided where deemed beneficial for major equipment. Where housekeeping pads are not provided, consider elevating equipment through the use of corrosion-resistant bases to mitigate the risk of damage due to flooding and to maintain clean-ability.

All mechanical rooms with wet equipment or water storage tanks, whether plumbing or HVAC related, shall be provided with not less than two industrial-grade water flood alarms that shall alert to the BAS, and alarm locally if water is detected. The number and location of sensors provided shall be sufficient to monitor the room for flood issues.

Entry to mechanical rooms shall be independent/ separate from the APF. A high level of MEP component labeling is required in these spaces, including directionality.

**O. Interstitial Areas:** Similar to mechanical rooms, the interstitial areas supporting a cGMP APF are highly trafficked for maintenance and operations activity, so accessibility of gauges, sensors, valves, etc. is important. Access ways and "swim lanes" must be planned and maintained. Where these are located directly above the APF, it is recommended that the floor plate below be painted on the floor of the interstitial for ease of pin-pointing relative position, floor-to-floor.

Floors of interstitial rooms shall be designed to prevent leaks. Exposed pan-deck, form-deck or similar is not an acceptable interstitial floor finish. Penetrations through the floor shall be protected, such as raised curbs and sleeves. All mechanical rooms with wet equipment shall be provided with room flood monitoring, reporting to the BAS.

---

### 13.3.5 Design Review and Design Qualification

**A. Design Review:** The review process should include considerations of constructability, maintenance, and testing.

**B. Design Qualification:** Review of compliance of design documents with GMP which needs to be demonstrated and documented. The process of design review and approval for GMP compliance may be integrated into the overall design review process.

## 13.3.6 Value Engineering (VE) and Sustainable Design Requirements

Section 1.7 Value Engineering describes the mandatory requirement for VE in projects where the construction cost exceeds a maximum value per OMB Circular-131, and Federal Procurement Policy Notices, Value Engineering shall be considered. Further, integration of sustainable design features into construction projects is mandated by law, regulation, executive order, and policy. The DRM shall not be used to abridge these requirements. Although the robustness and redundancy requirements in APFs are generally not compatible with such measures, all associated analyses and reports are to be performed as required.

**A. Value Engineering Proposals (VEP):** For all APF VEPs, a fully reviewed and accepted risk analysis must be prepared. The proposed value engineering shall not increase the risk to the product, patient, or worker; likewise, VE or sustainable features which increase the difficulty of O&M or reduce the robustness or resiliency (such as reducing the [n+x] redundancy of critical systems) shall not be considered.

**B. Guiding Principles of the Federal Leadership in High-Performance and Sustainable Buildings Memorandum of Understanding (MOU):** The guiding principles shall be incorporated into the planning, design, construction, operation, and maintenance of APFs to the extent practicable. Although neither U.S. Green Building Council's Leadership in Energy and Environmental Design (LEED) nor the Green Building Initiative's Green Globes System are designed to consider facilities of the nature of an APF, the guiding principles still need to be considered and documented. See Section 1.8.2 Sustainability Policy.

## 13.3.7 Commissioning and Validation Activities (Design)

The Commissioning Agent (CxA) or the Qualification Validation Agent (QVxA), or the integrated Commissioning, Qualification, Validation (CQV) Services Agent should be engaged early in the design phase. If the project utilizes a CQV approach, the agent will be responsible for both the VxA and CxA activities, as listed below.

### A. CxA Activities:

#### 1. Schematic Design Phase Activities:

- a. Participate in the Integrated Project Team (IPT)
- b. APF design review collaboration
- c. Develop testing matrix
- d. Begin Commissioning Master Plan (CMP)
- e. Document requirement matrix
- f. Document control and management

#### 2. Design Development (DD) and Construction Document (CD) Phase Activities:

- a. Develop Cx Specifications
- b. Review and comment on the following:
  - PVMP
  - Component level assessments (direct impact systems only)
  - Equipment specifications
  - Vendor documentation
  - Construction Quality Plan
  - Change Management
  - Construction and Startup Integration Planning
  - Design Submittals
  - FAT/SAT, as applicable

- c. Good Documentation Practices
- d. Confirm that the DQ has been fully executed

## B. QVxA Activities:

### 1. Schematic Design Phase Activities:

- a. Participate in the IPT
- b. APF design review collaboration
- c. Understanding the product manufacturing basis:
  - Identification of critical quality attributes (CQAs)
  - Critical process parameters (CPPs)
  - Critical materials/components (CMAs)
  - Critical aspects
- d. System list
- e. Process user requirements
- f. System boundaries
- g. Quality Risk Assessment (QRA)
- h. System Level Impact Assessments (SLIA)
- i. Develop testing matrix
- j. Begin Project Validation Master Plan (PVMP):
  - Design Qualification (DQ)
  - Commissioning Master Plan (CMP)
  - Qualification Plan (QP)
  - Installation Qualification (IQ)
  - Operational Qualification (OQ)
  - Performance Qualification (PQ)
  - Cleaning Validation (CV)
  - Computer System Validation (CSV)

- k. Document requirement matrix
- l. Document control and management

### 2. Design Development and Construction Document Phase Activities:

- a. Participate in the IPT
- b. APF design review collaboration
- c. Develop the PVMP
- d. Component level assessments (direct impact systems, only).
- e. Equipment specifications
- f. Vendor document requirements
- g. Construction Quality Plan (CQP)
- h. Design qualification
- i. Change management
- j. Construction and startup integration planning
- k. Good Documentation Practices (GDP)
- l. Development of Factory Acceptance Test (FAT) and Site Acceptance Test (SAT), as applicable
- m. Verify that the DQ has been fully executed

---

## 13.3.8 Document Change Control

Good Documentation Practice (GDP) describes the standards by which documents are prepared, reviewed, approved, issued, stored, maintained and archived. The control of documents related to the operation and maintenance of and within the APF, is particularly important, and in many cases, are codified by regulatory bodies.



Both the user group and ORF are required to develop, implement, and maintain systematic procedures, Standard Operating Procedures (SOPs), on a program and/or facility-specific process, procedures and requirements.

Document change management/change control procedures shall be developed and implemented during design and adhered to strictly, during design, construction and beyond. Each project develops its own change control and is subject to review and approval by the FCIS, DTR. The Document Change Control requirements shall be specified in the Project Execution Plan (PEP).

---

### 13.3.9 SOP for Construction

APFs which are intended to remain wholly, or partially in operation, or which will have operations temporarily suspended for construction or maintenance work shall have SOPs developed, reviewed and approved by DFOM, DTR, and the user. Any impact to the material, equipment, or personnel flows of a degree or duration, at the discretion of the user's QA, shall also update the record flow diagrams.

---

### 13.3.10 Non-Inspection FDA Meetings

The FDA describes two types of optional (non-inspection or filing) interactions with design teams working on prospective facilities. The NIH scientific program, in conjunction with the ORSC, CC will determine which FDA meetings are required and, will be the sole point of contact with the FDA on APF projects. The types of meetings include:

**A. Pre-operational Reviews of Manufacturing Facilities (FMD 135 Meeting):** According to Field Management Directive (FMD) 135, these meetings serve to provide field guidance when responding to requests from industry for reviewing plans for the construction of new or, modifications of facilities prior to commercial production. This meeting is generally between an interested party and the responsible district office. This type of

meeting is often undertaken to familiarize the district with a facility they will later inspect and to obtain feedback from the agency regarding possible errors or design defects. The review is a general discussion of the facility design and intended construction. The district may engage SMEs from the Center for Drug Evaluation and Research (CDER). The recommendations and other feedback are not binding on the FDA. FMD 135 reviews may occur at any or all of the following stages:

1. Design Review
2. Pre-Construction Review
3. Construction/Equipment Installation and Qualification Review
4. Pre-Production Review

**B. Type-C Meeting:** A Type-C meeting is any meeting other than a Type-A or Type-B meeting (Type-A and B meetings are generally non-facility related) between CBER or CDER and, a sponsor or applicant, regarding the development and review of a product. The Type-C meeting is scripted and scheduled per FDA policy. A designated NIH representative shall be the sole point of contact between the project team and the FDA. The project team shall generate a package of the necessary information to submit to the FDA, per the FDA document, "Formal Meetings Between the FDA and Sponsors or Applicants of Prescription Drug User Fee Act (PDUFA) Products Guidance for Industry." These materials shall be developed, reviewed and approved by NIH, prior to the FDA established due date which is typically 30 days prior to the formal meeting date. The Type-C meeting is generally scheduled when the planning and design are sufficiently mature for review and comment, but prior to initiating construction-phase activities. The APF user group and ORSC shall coordinate the timing, nature, and number of requested meetings and other contacts with the FDA.

---

### 13.3.11 Deliverables (Design)

The following required deliverables may vary based on size and complexity of individual projects. Not all of the following will apply to every APF project.



**Note:** These are above and beyond [Appendix E: A/E Submission Requirements](#), which addresses typical requirements, such as design drawings, specifications, calculations, etc.:

1. Updated feasibility study report(s)
2. Updated QRM & risk analysis report(s)
3. Updated GxP harmonization report
4. Updated project execution plan (PEP)
5. Updated user requirement specifications (URS)
6. Updated room data sheets (RDS)
7. Updated process flow diagrams with narrative
8. Updated equipment schedule
9. Updated FDA meeting document packages
10. Meeting minutes
11. Updated validation master plan (VMP)
12. Updated construction quality plan
13. Updated SAT/FAT protocols

Other documents may be updated and submitted for review as required, as specified in the PEP.

## 13.3.12 Document Review and Approval (Design)

There are many documents and processes that are specific to APF projects. Some of these documents are subject to validation (approved by a signature from appropriate parties), and some are subject to review by parties above and beyond those specified in [Section 1.5.3.3 NIH Technical Review Staff. Table 13.3.12 APF Document Review and Approval \(Design\)](#), below, provides a typical framework for the documents associated with this phase, although there will be some facility and project-specific variations, so this table should be considered as general and informative, but not exhaustive or inclusive of the document requirements of a specific project. Those specific requirements should be developed during this phase and documented in the PEP.

Table 13.3.12 APF Document Review and Approval (Design)

Document	Signed	Controlled	PO/COR	Per DRM Section 1.5.3.3	FCIS	ORSC	DFOM	NIH Program (User)	User QA	External Regulatory Agencies
Project Execution Plan (PEP) by Final Design	•		IRS		R	R		RS	R	
Basis Of Design (BOD)	•	•	IRS	R	RS	RS		RS	R	R
Program Questionnaire	•		IRS	R	R	R		R	R	
Room Data Sheets (RDS)			IRS	R	R	R		R	R	R
Process Flow Diagrams (PFD)	•		IRS	R	RS	RS		RS	RS	R
Equipment Schedule	•		R	R	R	R		IRS	IRS	
Piping and Instrumentation Diagrams (P&ID)			IRS	R	R			R	R	
GxP Harmonization Report	•	•	R	R	RS	RS		IRS	RS	R
User Requirement Specifications (URS)	•	•	R	R	RS	RS		IRS	RS	R
Feasibility Study Report(s)	•		IRS	R	RS	RS	R	RS	RS	R
Quality Risk Management (QRM) Report	•		R		RS	RS		IRS	RS	R
Final Design Contract Documents (Dwgs., specs., etc.,)	•	•	IRS	R	R	R	R	RS	RS	
Validation Masterplan (VMP)	•	•	IRS	R	RS	RS	R	IRS	RS	
Project Validation Masterplan (PVMP)	•	•	IRS	R	R	R	R	RS	RS	
Commissioning Masterplan (CMP)	•	•	IRS	R	RS	R	R	RS	RS	
VE and Sustainable Design Analysis			IRS	R	R	R		R	R	R
Change Management (Project) SOP	•	•	IRS	R	RS	R		RS	R	
FDA meeting document package(s), if applicable	•		IRS	R	R	R		RS	R	R
Test Protocols as applicable per Section 13.17	•	•	IRS	R	RS	R	R	RS	RS	
SAT/FAT Protocols, where applicable	•	•	IRS	R	RS	R	R	RS	RS	
SOPs for Construction Phase	•	•	IRS	R	RS	R		RS	RS	
Construction Quality Plan (CQP), if D/B	•	•	IRS	R	R	R		R	R	

I Initiated By

R Reviewer

S Signatory

Note: Unless indicated otherwise, PO/COR is responsible for the management of the above document(s).

# Section 13.4

## Biologics Facilities

---

### Contents

13.4.0 Introduction

13.4.1 General Plan Arrangement

13.4.2 Biologics APF Design Recommendations

## 13.4.0 Introduction

Biologics production facilities at NIH manufacture cell therapy products, including live cellular materials such as stem cells, T-Cells, for autologous or allogeneic administration to patients as part of Phase I and II clinical trials. Cell therapy involves the transplantation of these live cellular materials into patients, primarily for treatment or prevention of diseases, by repairing a lost or defective function. Regulations require that cell therapy products, intended for patients, be done in a cGMP facility. Cellular therapy products are thus manufactured in compliance with 21 CFR 1271 (Good Tissue Practices), 21 CFR 211, and related cGMP expectations.

These facilities are typically designed for the manufacture of multiple products, either concurrently, or sequentially (campaigned), although there are some dedicated, single-product facilities. Known infectious biological material is processed in BSL-2, ISO 7 cleanrooms, separate from biological material that has tested negative for infectious diseases.

Based on discussions with the user, the A/E shall document, the following minimum information about the intended manufacturing processes in the BOD:

1. Nature of the starting material – primary human cells vs. cell line(s).
2. Nature of the process: Infectious vs non-infectious vectors or other materials present that will impact design decisions.
3. Nature of processes to be performed: Ex vivo expansion culture, cell selection, gene modification, etc., noting any open vs. closed process steps, in particular.
4. The number of products to be produced: Dedicated (single product) vs. multiple product (Concurrent or campaigned) production.
5. Nature of the temporal segregation of processing activities, in multiple product facilities. Note approximate duration of process steps, particularly open process steps. Note temporal segregation of processing activities, including periods of active processing and inactive intervals (e.g., product in incubator).

6. Whether the production is a single, or multiple room process.
7. Dedicated vs. shared equipment.
8. Whether cells from multiple patients/donors be processed in the same cleanroom contemporaneously?
9. Flow pathways for personnel, raw material, processed material, and waste (Unidirectional flow is preferable), etc.
10. Whether the product will ship extra jurisdictionally, particularly to EU-located partners?

---

## 13.4.1 General Plan Arrangement

Good Manufacturing Practices dictate a progression of spaces that lead from unclean and uncontrolled spaces to, progressively cleaner spaces. The transition between these spaces is maintained by design of the facility, the mechanical systems supporting the facility and by adherence to SOPs. Conformance to these requirements is carefully monitored to ensure ongoing compliance.

The FDA regulations, specifically CFR 211, calls for the segregation of activities/operations to prevent cross-contamination and mix-ups. Contamination, including microbiological and by endotoxin(s) can result from environmental conditions, personnel, handling of materials, and/or crossed contamination with other products prepared within the same suite (but in separate rooms). Thus the design of a GMP facility, its engineering controls along with, procedural controls can mitigate the risks associated with contamination of the product being produced at the facility.

Potential sources of contamination may include but are not limited to:

### A. Personnel Issues:

1. Inadequately trained personnel
2. Personnel not following SOPs
3. Donning/Doffing improper, inadequate or contaminated PPE

4. Direct contact between the operator's hands and starting materials, primary packaging materials or product
5. Defective/improperly released raw materials (including packaging materials)

**B. Facility Issues:**

1. Inadequate facility design in terms of unidirectional flow, adequate steps between ISO classification changes, etc.
2. Contamination of ventilation air, water, compressed gasses, or other utilities
3. Inadequate lighting
4. Improper architectural finishes and details
5. Excessive noise and vibration
6. Non-unidirectional airflow
7. Inadequate hand hygiene, toilet, and locker facilities to allow for sanitary operation

**C. Combination Personnel and Facility Issues:**

1. Insufficient size and inadequate organization of the space leading to selection errors like mix-ups or cross-contamination between consumables, raw materials, in-process materials, and finished products
2. Insufficient size and/or inadequate organization of PPE donning/doffing spaces
3. Improperly maintained and/or operated production equipment
4. Cross-contamination or mix-ups with finished or semi-finished material; and others.
5. Improper cleaning procedures and/or materials
6. Improper pest management
7. Known infectious biological material is processed in BSL-2, ISO 7 cleanrooms, not kept separate from biological material that has tested negative for infectious diseases.

## 13.4.2 Biologics APF Design Recommendations

**A. Changing/Locker Room:** Changing rooms are for the donning and doffing of street clothes to a uniform base garment, typically scrubs, for entry into the APF as well as upon exit. Sufficient space shall be allocated for this process. Changing rooms are typically CNC. Equipment and furniture in a changing room often include scrub dispensers, lockers, benches, and provision for hand hygiene.

Locker rooms, where separate from changing rooms, shall be located near the changing rooms. Equipment and furniture in a locker room often include lockers, benches, and provision for hand hygiene. Locker rooms with CNC Toilet facilities are generally not co-located with APF changing/locker rooms to mitigate the risk of contamination. Locker rooms are typically provided only at larger facilities.

Where hand hygiene is performed, follow the below design requirements:

1. Provide a hands-free hand washing/hygiene sink of adequate dimensions to allow for washing up to the elbow.
2. Locate the sink near the entry door when possible (i.e., closer to the dirty-side).
3. Provide an eyewash located at the sink or an eyewash station.

**B. Gown-In Room:** Gown-In Rooms are generally, part of the entry anteroom sequence. If not performed in the CNC areas, ISO class 8 can be used for personnel, garbing (donning 1st or 2nd layer of PPE), staging of components, and other activities that potentially generate high levels of particulates. A rectilinear footprint is preferred, without offsets for achieving uniformity of airflow. Sufficient area for donning/doffing PPE is essential, with attention given to single direction, non-crossing movement. In bidirectional facilities, segregate the flow to the extent practicable. See [Section 13.3.3 APF Design Considerations](#).

Design recommendations:

1. A bench for PPE garbing may be provided.
2. Full-length mirror for visual inspection of PPE.

**C. Clean Corridor:** The clean corridor typically connects the changing/locker room, via an airlock, to the entry airlock(s) of one or more aseptic processing rooms. Often, a material airlock to the clean storage is provided to move materials and supplies to the aseptic processing rooms. Clean corridors are typically ISO 8 or better. In a unidirectional flow facility, there will be corresponding material pass throughs to move this material into the entry airlocks, or directly into the aseptic processing rooms.

**D. Airlock/Anteroom:** Airlocks shall be provided as buffers to allow personnel to proceed through multiple stages of gowning protocols, as appropriate, for the level of risk. Airlocks are typically provided at the entry and exit of processing rooms, for personnel gowning and de-gowning. Entry airlocks shall be the same ISO classification as the aseptic processing room they serve, while return airlocks may be lower. See [Section 13.8.9 Airlocks](#) for additional information.

**E. Aseptic Processing Room:** An aseptic processing room (often referred to as a tissue culture room or cleanroom) shall serve as the processing room for cell therapy products in Biologics APFs and is the most critical of the rooms. Aseptic processing cleanrooms commonly house the PECs (i.e., BSCs), associated cell processing equipment (i.e., incubators, centrifuges, etc.), and mobile casework. These rooms may be equipped with small refrigerators or freezers within the clean classified environment for intermediate storage of materials during processing. Water sources, such as sinks or floor drains, are not permitted in Aseptic Processing rooms. Communication devices such as intercoms and cameras should be used to minimize traffic between areas. Aseptic Processing rooms are typically ISO 7 but may be ISO 8 if all work is performed in isolators.

For Biologics APFs using viral vectors or other infectious, or potentially infectious materials, the Aseptic processing suite shall be ISO 7, but negative to adjacent space. This requires an ISO 7 anteroom, because the air from the anteroom will move into the aseptic processing room. A second anteroom, an ISO 8, is generally utilized beyond the ISO 7 anteroom, as a cascade, to transition to adjacent spaces.

**Return Corridor:** A return corridor is similar to an exit corridor, but is typically ISO 8 or better and configured to allow a return to the clean corridor, after some proscribed donning and doffing of PPE and other steps

as required to mitigate the risk of cross-contamination. Return corridors also typically allow access to storage and/or freezer rooms, then out of the suite. In a unidirectional flow facility, there will be pass throughs to then move processed material and waste into the exit corridor.

**Bidirectional Anteroom:** Provide dedicated gowning rooms for entering and exiting processing rooms to reduce the risk of residual contamination on a dirty (exiting) garment from contaminating clean (entering) garments. SOPs shall disallow the non-concurrent donning and doffing of PPE in bidirectional anterooms. Bidirectional flow traffic in shared gowning rooms may be allowed in small APFs and only based on risk assessment and at the approval of NIH.

**Freezer Room:** Freezer Rooms are common in Biologics APFs. Freezers shall be used for storage of intermediate and long-term products. These may consist of liquid nitrogen (LN<sub>2</sub>) storage freezers, ultralow temperature (-80°C) mechanical freezers. Programmable (controlled-rate) freezers typically located in freezer rooms. Under counter refrigerators may be used for daily storage. LN<sub>2</sub> freezers (storage tanks) and mechanical freezers shall be on emergency power and will require IT drops. LN<sub>2</sub> should be supplied from an external bulk supply tank, or from locally stored cryogenic liquid cylinders. Where necessary to safely facilitate supply change out without entering classified space, LN<sub>2</sub> supply should be located outside classified space and connected to the use points via a DRM compliant piping system, which shall be vacuum jacketed. LN<sub>2</sub> freezer rooms shall be provided with O<sub>2</sub> depletion monitors tied to the BAS.

**Logistics Rooms:** Within the CNC areas, each Biologics APF will typically have space for pickup, receiving, reviewing, recording and storage (quarantined/dirty and released/clean) of raw materials, finished product, cleaning supplies, etc. Sufficient storage area for carts shall be provided along with space for bulk storage, active storage, supply storage, etc. There shall also be areas for packaging, labeling and storage of finished product. Adequate space shall be provided for these activities to minimize the chances of mix-up.

**Pass Through Boxes, Chambers, or Cabinets:** Refer to [Section 13.6.5 Wall Accessories](#).

See [Section 13.3.4 Common APF Design Elements](#) for additional rooms and requirements.



# Section 13.5

## Compounding Pharmacy Facilities

---

### Contents

- |   |   |
|---|---|
| 13.5.0 Introduction   | 13.5.5 Primary Engineering Controls (PEC) |
| 13.5.1 Pharmacy: Compounding Regulations                              | 13.5.6 Buffer Areas                       |
| 13.5.2 Compounded Sterile Preparations (CSP)<br>USP <797> Risk Levels | 13.5.7 Anteroom Requirements              |
| 13.5.3 Hazardous Drugs (HD) as CSPs USP <800>                         | 13.5.8 Pharmacy Support Areas             |
| 13.5.4 Direct Compounding Area (DCA)                                  | 13.5.9 Radiopharmacy Design Requirements  |

## 13.5.0 Introduction

A compounding pharmacy refers to a facility or suite that, under license and by prescription by a physician or other legally authorized prescriber, mixes or "compounds" chemical ingredients into a finished medication that is ready to use by an individual patient.

NIH Compounding Pharmacy facilities are part of the Aseptic Processing Facilities (APF) portfolio where medications used for NIH clinical trials are manufactured, stored and dispensed. The products dispensed shall be sterile (if so specified), of correct identity (ingredients), purity (free from contaminants), and strength. The products must be dispensed into sterile, accurately labelled containers, and stored in carefully monitored and controlled environments, appropriate for the products being stored.

Compounded sterile preparations (CSPs) may be stored for extended periods before use, during which time it is possible for contaminating microorganisms to grow, particularly if appropriate compounding and storage conditions are not met. Contaminated CSPs can cause patient health complications or even death and, negatively impact clinical trial data quality. Mitigating these risks is the principal purpose behind the requirements described in this chapter.

The combined effort of appropriate engineering and administrative controls through facility design, construction, and O&M ensures that the facility environment can be operated in a state of control, produce the appropriate environment for CSP preparation, storage and dispensing.

In all APF Pharmacy facilities, airflows are controlled and monitored such that air flows from clean to dirty areas while control of staff, equipment, and material flow increases from dirty to clean. Generally this is accompanied by a positive pressure cascade to keep the product isolated from the surrounding environment, but in a hazardous compounding area (described in more detail in [Section 13.8 APF Design Requirements: HVAC](#)), air flow shall be negative to the adjacent room with appropriate engineering and administrative controls for the contamination risk levels defined in USP <797>. In all APFs, consideration shall be made for relationships between the anteroom(s), buffer, gowning, segregated and storage areas in workflow patterns as they will affect air quality.

## 13.5.1 Pharmacy: Compounding Regulations

USP is a scientific nonprofit organization that sets public standards for the identity, strength, quality and purity of medicines. The federal Food, Drug and Cosmetic Act (FDCA) specifically references and mandates USP standards for compounding. Parties responsible for compounding medicines are required to comply with USP's Chapters and Monographs:

1. USP <795> Pharmaceutical Compounding Nonsterile Preparations
2. USP <797> Pharmaceutical Compounding Sterile Preparations (CSP)
3. USP <800> Hazardous Drugs – Handling in Healthcare Settings
4. USP <823> Radiopharmaceuticals for Positron Emission Tomography (PET)
5. USP <1160> Pharmaceutical Calculations in Pharmacy Practice
6. USP<1163> Quality Assurance in Pharmaceutical Compounding
7. USP<1176> Prescription Balances and Volumetric Apparatus Used in Compounding

USP Chapters for Compounding Facilities define where sterile or non-sterile preparations are performed. Sterile compounding differs from nonsterile compounding primarily by requiring the maintenance of sterility when compounding exclusively with sterile ingredients and components and, the achievement of sterility when compounding with nonsterile ingredients and components. A primary difference between nonsterile and sterile compounding is that clean conditions, not aseptic conditions, are required for non-sterile compounding. Some other differences between standards for sterile compounding and those for nonsterile compounding in Pharmaceutical Compounding Nonsterile Preparations (795) include, but are not limited to: ISO classified air environments; person-classified air environments; personnel garbing and gloving; personnel training and testing in principles and practices of aseptic manipulations and sterilization; environmental quality specifications and monitoring; and disinfection of gloves and surfaces of ISO Class 5 sources.

## 13.5.2 Compounded Sterile Preparations (CSP) USP <797> Risk Levels

USP <797> shall be followed when preparing compounded sterile human and animal drugs to ensure the sterility of any CSPs. CSPs consist of injections; aqueous bronchial inhalations; baths and soaks for live organs and tissues; irrigations for internal body cavities; ophthalmics; implants, etc.

USP <797> categorizes contamination risk in the preparation of CSPs. A determination of the level of risk should be made for each facility where CSPs are compounded to assure that policies and practices established for the area respond to the risk level present.

The risk to the sterility of the product, associated with a CSP depends on a number of factors. CSP microbial risk categories are assigned primarily according to the potential for microbial contamination. They are distinguished primarily by the conditions under which they are made and the time within which they are used. They are categorized into two (2) categories, (per the USP <797> proposed revisions:

1. **Category 1 CSP:** This is a CSP, assigned a Beyond Use Date (BUD) of 12 hours or less, at controlled room temperature or 24 hours or less, refrigerated. A PEC may be placed within an unclassified, segregated compounding area.
2. **Category 2 CSP:** This is a CSP assigned a BUD of greater than 12 hours at controlled room temperature or greater than 24 hours, refrigerated. Category 2 CSP must be prepared in accordance with all applicable standards for Category 2 CSPs per USP <797> which dictate a cleanroom environment with separate buffer and Anteroom. PEC shall be placed in an ISO 7 classified buffer room.

**Urgent-Use USPs:** Urgent use USPs are utilized in situations where there is a need for emergency or immediate patient administration of a CSP (e.g., pulmonary resuscitation) for:

1. A single patient AND when preparation under Category 1 or 2 would subject the patient to additional risk due to delays in therapy.

2. Compounding procedure must be a continuous process not to exceed 1 hour AND administration of the CSP must begin immediately upon completion of preparation of the CSP.
3. During preparation, aseptic technique is followed AND procedures must be in place to minimize the potential for contact with non-sterile surfaces, the introduction of particulate matter or biological fluids, and mix-ups with other CSPs.

## 13.5.3 Hazardous Drugs (HD) as CSPs USP <800>

Any antineoplastic Hazardous Drug (HD) requiring manipulation and HD Active Pharmaceutical Ingredients (API) on the “NIOSH List of Antineoplastic and Other Hazardous Drugs in Healthcare Settings” current edition, must follow USP <800> for the preparation and storage of HDs. HD preparation and storage shall be designed to protect the healthcare workers and other personnel in the preparation, handling, and storage of HDs.

HD shall be stored separately from other inventory in a manner to prevent contamination and personnel exposure; however, sterile and non-sterile HDs may be stored together. Many HDs have sufficient vapor pressures that allow volatilization at room temperature. Because of this, storage is preferably within a negative pressure containment area. The storage area should have sufficient general exhaust ventilation, at least 12 air changes per hour, to dilute and remove any airborne contaminants.

## 13.5.4 Direct Compounding Area (DCA)

The DCA is the critical area within the ISO 5 Primary Engineering Control (PEC) that is exposed to unidirectional HEPA-filtered first air. This may consist of the following:

1. ISO 5 HEPA-filtered Biological Safety Cabinet (BSC) within an ISO 7 (or better) buffer room.
2. Isolator, within an appropriate ISO level buffer room
3. An ISO 5 (or better) room

See Figure 13.5.4 Diagram indicating progressively cleaner sequence of compounding pharmacy facilities.

**Figure 13.5.4 Diagram indicating progressively cleaner sequence of compounding pharmacy facilities**

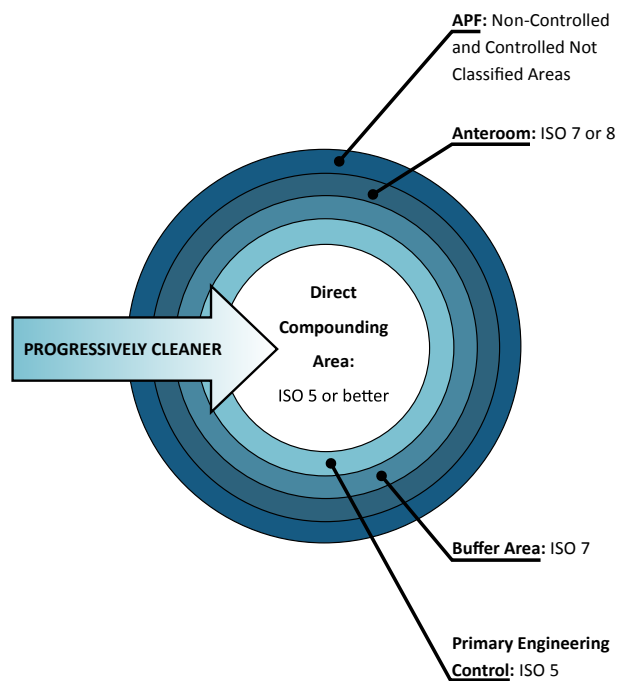

### 13.5.5 Primary Engineering Controls (PEC)

The basic design for the compounding space shall consist of an ISO Class 5 Primary Engineering Control (PEC) located within an ISO Class 7 room such as a buffer, intravenous (IV), or chemotherapy (chemo) room. Access to the ISO Class 7 rooms shall be through an ISO Class 7 anteroom. Proper placement of PEC is critical to ensuring an ISO 5 environment for compounding PECs. PECs shall be located out of traffic

patterns and away from circulating air currents (See [Appendix A: Biological Safety Cabinet \(BSC\) Placement Requirements for New Buildings and Renovations](#)). Both Laminar Airflow Flow Workstations (LAFW) and BSCs may be used. LAFWs provide an ISO 5 unidirectional environment with horizontal HEPA air flowing from the back of the LAFW toward the open front. Vertical LAFWs shall not be used. BSCs provide open front and inward and downward HEPA filtered air HEPA exhaust. The overall design shall enable one or more BSCs to remain in use should the other(s) become inoperable.

**A. Containment Primary Engineering Control (C-PEC):** This is an externally vented Class II or III biological safety cabinet (BSC) or compounding aseptic containment isolator (CACI) with HEPA filtered exhaust, as required by the program. Such a device is not required for manipulations of intact, final products unless they produce aerosols, gases, or powders. All C-PECs used for manipulation of sterile HDs shall be externally vented. A C-PEC does not have to be within an ISO 7 space but should be in a separate negative pressure room. The C-PEC is designed to minimize worker and environmental HD exposure when directly handling HDs.

The C-PEC may be placed in an ISO Class 7 buffer room that has a negative pressure between 2.5 and 7.5 Pa (0.01 and 0.03 in. w.g.) and has a minimum of 30 ACPH of HEPA-filtered supply air.

**B. Compounding Aseptic Isolator (CAI):** When a CAI is used for compounding, in lieu of the Intravenous (IV) solutions area, it may be prepared within the pharmacy provided it complies with the following:

1. The CAI shall provide isolation from the room. The CAI provides ISO Class 5 levels during dynamic/operating conditions, including transferring raw materials, ingredients, components, and devices into and out of the CAI and during the preparation of CSPs.
2. The particle counts sampled shall be 152 to 305 mm (6 to 12 inches) upstream of the critical exposure site within the CAI.
3. The CAI shall maintain ISO Class 5 levels during compounding operations.

## 13.5.6 Buffer Areas

A Buffer Area is an ISO 7 area where the PEC is physically located. During operations, the Buffer is continually monitored for viable and non-viable particles, to ensure that the concentration of airborne particles is controlled. Environmental Monitoring (EM) of the air, personnel, and surfaces are conducted per SOP (as mandated by USP <797>) to ensure that allowable microbial levels are not exceeded. Activities in the Buffer Area include the preparation of CSPs, and the staging of ingredients, components and other supplies for the product being produced.

All CSPs (except possibly Category 1, if supported by risk analysis and approved by Pharmacy QA) must be compounded in the clean area with buffer and anteroom.

Water sources, such as sinks or floor drains, should not be immediately adjacent to segregated compounding areas outside of a buffer area, and are not permitted in the buffer area. This area may include a limited amount of shelving and/or carts for the staging of compounding (not for storing stock). Moving in and out of the buffer area may increase airflow interruption. Communication devices such as intercoms and cameras should be used to minimize traffic between areas. This is generally true of all APFs, but particularly important in this application. There shall be a systematic process of entering and exiting the various areas to minimize contamination.

**A. Containment Secondary Engineering Control (C-SEC):** A C-SEC is a room in which the C-PEC is placed. Hazardous drugs shall be prepared in an area that is physically segregated (a different area from the other CSP areas). C-SEC must be externally ventilated via a HEPA filter. Sterile HD compounding must be performed in a Containment PEC (C-PEC) that provides an ISO Class 5 or better air quality (e.g., a Class II or III BSC or CACI), and Class II BSC types A2, B1, or B2 are acceptable).

**B. Containment Segregated Compounding Area (C-SCA):** Under USP <800> a C-SCA is intended to house a CACI (that meets the requirements listed in USP <797>) for the compounding of low or medium risk sterile hazardous drugs and must exhaust a minimum of 12 ACH. C-SCA is not acceptable for high-risk HD compounding. C-SCA areas must be cleanable, access controlled, and supplied with HEPA filtered air.

**C. Intravenous (IV) Solutions Room:** A sterile work area shall be provided for Intravenous (IV) preparation, where required by the program. The IV solutions room work area shall consist of a preparation room, PEC room and a separate chemo PEC room, where required. Access to the preparation room shall be through the pharmacy only; while access to the PEC room or chemo PEC room shall be through the preparation room only.

The associated preparation room shall provide ample work counter, gowning area, and shelving. A hand hygiene fixture with hands-free controls shall be in the preparation room and within 1.5 m (5 ft.) of each entrance to the PEC or chemo rooms. Hand hygiene fixtures and floor drains are not allowed inside the PEC or chemo rooms.

---

## 13.5.7 Anteroom Requirements

The anteroom is an ISO class 8 or better area which provides space for personnel to perform hand hygiene, garbing (donning PPE), staging of components, order entry, CSP handling, and other activities that potentially generate high levels of particulates. It is also a transition area that ensures pressure relationships are maintained between designated areas during normal and conditions of large disturbances in the HVAC system. The ante area further segregates the buffer area from less-clean areas of the facility. The ante area should have a rectilinear footprint, without offsets for achieving uniformity of airflow.

Design requirements:

1. Provide a hands-free hand washing/ hygiene sink of adequate dimensions to allow for washing up to the elbow.
2. Locate the sink near the entry door when possible (i.e., closer to the dirty-side).
3. Provide an eyewash located at the sink or an eyewash station.
4. A bench and storage facilities or lockers for personnel garbing shall be provided.
5. Full-length mirror for visual inspection of PPE.



## 13.5.8 Pharmacy Support Areas

The pharmacy support areas, described in this section are outside the ISO classified areas, however, they are essential to the function of the pharmacy. The specific composition and room requirements for these spaces will be dictated by the facility program, but may include all or some of the following:

**A. Material Receiving/Breakdown:** This room/ area should be located at the perimeter of the APF, with good access to the loading dock, and shall have sufficient space for receiving, breakdown, inspection, storage of supplies/materials intended for use within the pharmacy areas. Materials from this room are moved to the appropriate storage room(s) and reduced to minimum packaging (i.e., no cardboard). Initial checks are performed here to begin the quality inspection of the product and its paperwork.

**B. Storage Rooms:** Ideally located within the pharmacy suite, this room shall have adequate space for pickup, receiving, reviewing, recording and storage of sterile supplies. There should be areas for carts; space for bulk storage, active storage, and refrigerated storage; a fire safety cabinet or storage room that is constructed under the requirements for protection from hazardous areas in accordance with NFPA 101, Chapter 12, for volatile fluids; a secure vault, safe, or double locking wall cabinet for narcotics and controlled drugs; and space for general supplies and equipment not in use. There shall also be areas for quality assurance activities. Storage of hazardous drugs shall be segregated from all other inventory.

There shall be separate “cleared” and “quarantined” storage areas/rooms as defined by the program. If these areas are in the same contiguous space, there shall be a demarcation line between “clean” and “dirty” areas of the space.

---

## 13.5.9 Radiopharmacy Design Requirements

Radiopharmaceuticals are associated with the risk of radiation exposure to personnel. The radiopharmacy

facilities shall comply with all appropriate pharmacy requirements and Nuclear Regulatory Commission (NRC) regulations. Radiopharmaceutical CSP must be prepared in a cleanroom environment with separate buffer and anteroom. PEC shall be placed in an ISO 7 classified buffer room.

A radiopharmacy shall be designed to have a multilayer system of protection, such that a failure at one layer is compensated for by subsequent layers, for the purposes of:

1. Preventing accidents that may cause exposure
2. Restoring safe conditions after an accident
3. Mitigating the consequences of any such accident that does occur

The radiopharmacy facilities shall additionally have the following special features in the radioactive substances preparation area:

1. Provide a secure, shielded storage area for radioactive substances. This may be a room, area, or a locked cupboard, safe, refrigerator, or freezer, situated in the work area.
2. Shielded temporary storage of solid radioactive waste and places designated for the disposal of liquid radioactive waste, and in no cases, directly connected to the main sewer.
3. Shielding to protect workers where significant external exposure may occur; a wash-up area for contaminated articles, such as glassware.
4. Subject to approval by the ORS Division of Radiation Safety (DRS), and the ORF Division of Environmental Protection (DEP), drains from radiopharmacy sinks shall route as directly as practicable to the main building sewer and should not connect with other drains within the building. The intent of this requirement is to minimize the possibility of a ‘backup’ contaminating other, non-controlled, areas.
5. All drains that carry potentially radioactive waste shall be labeled, and accurately depicted on the record of work as constructed documents.



6. Pipes through which radioactive materials flow shall be marked to ensure that monitoring precedes any maintenance.
7. Where waste piping is required to be routed to any type of storage vessel (including for short-term half-life reduction) and for other conditions required by DRS or DTR, such radwaste piping shall be double contained Type 316 L stainless steel pipe or tubing of not less than Schedule 10 wall thickness (except that applications with high levels of chlorides shall be Hastelloy C22), and with radius pattern fittings. Piping joints for the internal carrier pipe shall be smooth and crevice-free, with complete joint penetration (CJP) ASME BPE type weld design (including or similar to autogenous orbital) for the primary carrier. Post-weld pickling and passivation is required for stainless steel systems. The containment annulus shall be of approved stainless steel, PVDF, or polyolefin material appropriate to the application and exposure, joined by a thermal fusion process and provided with automatic, segmented low-point leak detection.
8. Pressurized fluid piping containing radioactive liquids shall be double contained Type 316 L stainless steel of not less than Schedule 10 wall thickness. Piping joints for the internal carrier pipe shall be smooth and crevice-free, with ASME BPE type autogenous orbital weld design for the primary carrier and post-weld system pickling and passivation is required. The containment annulus shall be joined by heat fusion or weld methods and shall be provided with automatic, segmented low-point leak detection. Bundling of multiple compatible pressurized lines into common containment shall be approved at the discretion of DTR and DRS.

**Additional Radiopharmacy Design Requirements:**

1. Provide an entry/gowning/locker room area donning and doffing of PPE, and where washing and contamination monitoring can be performed. Provide a wash-up sink adjacent to the work area, out of the main traffic flow, as practicable. Faucets shall be operable without

direct hand contact and lint-free disposable hand towels should be available. An emergency eyewash shall be installed near the hand washing sink.

2. There should be nearby access to an emergency shower for decontamination of persons in or near the laboratory. Do not provide a floor drain in this location. The temperature setting of this emergency decontamination fixture shall be confirmed with DRS for each application. Provide dedicated emergency fixture mixing valves where higher temperatures than otherwise permitted in [Section 8.3 Water Systems](#) are required.
3. Radiopharmacies which will fill phantoms shall have deep sinks and foot pedal or knee controlled faucets in lieu of sensor controlled faucets.
4. Signage shall be per the requirements set forth in [Appendix M: Interior Signage Manual](#). Confirm the program requirements and with DOHS. Additional information required to be posted includes:
  - a. Access restrictions (on applicable doors)
  - b. Name and telephone number of lab director on entry/exit door(s)
  - c. Special requirements such as the required use of PPE, personnel access (on applicable doors)
  - d. Signage material shall be resistant to degradation by decontaminants. Fully seal sign to the mounting surface.
5. The surfaces (i.e., bench tops, tables, seats, etc.) of the room where radionuclides are used or stored shall be smooth and non-absorbent so that they can be cleaned and decontaminated easily.
6. The outlets for supplies (e.g., gases, electricity, and vacuum equipment) shall be mounted on walls or stands (not on bench tops) unless otherwise dictated by program need.

7. The floor and benches, including worktops, shall be strong enough to support the weight of any necessary shielding materials or of radionuclide (Tc) generators, or other heavy, shielded equipment. The need for lifting equipment for radionuclide generators should be assessed.
8. If radioactive aerosols or gases may be produced or handled, provide an ventilation system that includes an appropriate PEC (fume hood, laminar airflow cabinet or glove box). The working surface of the PEC should have a slightly raised lip to contain any spills.
9. The ventilation system shall be designed such that the suite is at a negative pressure relative to surrounding areas, except where required to contain radioactive powders, gases, or similar materials. The airflow shall be from areas of minimal (lower) likelihood of airborne contamination to areas where such contamination is likely.
10. All air from the suite should be exhausted through a PEC or LSW exhaust grill to the exhaust system and shall not be recirculated either directly, in combination with incoming fresh air in a mixing system, or indirectly, unless approved by DRS and DTR.
11. Some radiopharmacy spaces may require a positive, rather than a negative pressure, relative to the surrounding rooms. In this case, the pressure gradient can be obtained by a sink anteroom separating the ISO 7 compounding room (Cleanest and with its own exhaust), from another workroom, preceded by a bubble anteroom, or similar arrangement to promote asepsis.
12. Controlled access is required to gain entry to the source storage and preparation areas.

There shall be adequate provisions for the calibration, quality assurance, and operation of diagnostic and therapeutic equipment. This may include, but not be limited to maintaining adequate service and use clearances around the equipment; accessible test ports; and other provisions to facilitate these activities.

# Section 13.6

## APF Design Requirements: Architectural

---

### Contents

13.6.0 Introduction

13.6.1 Ceilings

13.6.2 Walls

13.6.3 Doors & Hardware

13.6.4 Windows

13.6.5 Wall Accessories

13.6.6 Floors

13.6.7 Furnishings

13.6.8 High-Performance Coatings

13.6.9 Modular Components

13.6.10 Caulks and Sealants

13.6.11 Mock-ups

13.6.12 Finish Cleaning Schedule

## 13.6.0 Introduction

Architectural finishes and details are a critical system for the overall performance of APFs. The design and selection of APF architectural surface finish systems, materials and details must promote cleaning, maintenance and proper operations. All surface finishes shall be selected to be compatible with the anticipated agents and methods used for cleaning, disinfection or sterilization and protocols used by the program without damage or degradation, including discoloration. See [Section 4.4.5 Wall and Ceiling Finishes for Aseptic Facilities, BSL-3, ABSL-3, and Similar Facilities](#).

Surface finishes shall not be selected based on a first-cost, but on a life-cycle cost basis for the facility. Systems shall be impact resistant and shall have smooth, sealed joints and transitions, eased outside corners and coved inside corners.

Surface finish selection shall take into consideration the following factors:

**A. Material:** Finish material shall be non-particle generating; inert; impervious, non-absorptive; not harbor or sustain mold or microbial growth; all joints and penetrations properly detailed and constructed; configured without recessed areas and voids that are difficult to access for cleaning and pest management (See [Section 1.12 Integrated Pest Management](#) and [Section 13.15.4 Pest Management](#)).

**B. Cleanable:** Architectural finishes shall be seamless/monolithic; easily cleaned, sanitized, and maintained; smooth; monolithic; designed such that sharp corners (particularly inside corners), joints, crevices and other conditions that can collect dirt shall be eliminated to the extent practicable; horizontal surfaces (i.e., large horizontal surfaces, including bench tops, floors, seats, etc., as well as small horizontal surfaces such as window ledges, electrical raceways, etc.) shall be minimized.

**C. Durable:** Material shall be able to withstand regular exposure to aggressive cleaning and sanitizing chemicals and cleaning processes without degradation, abrasion, impact, and overpressure damage resistant. Existing materials which can be damaged by anticipated use and maintenance must not be reused or shall be protected (i.e., wall protection panels, etc.).

Some typical cleaning agents used individually, sequentially, or in combination at APFs include, but are not

limited to:

1. Sodium hypochlorite
2. Hydrogen peroxide
3. Peracetic acid
4. Isopropyl alcohol

Material selections shall be laboratory tested against the agents and methods used for cleaning and sanitization as well as all agents identified by the program that will be used at the facility. Testing shall be performed for agents individually and in sequential combination. It is recommended that testing is performed for failure to adequately remove/neutralize exposure to peracetic acid. If a record of performance with agents is not available, then a mock-up test shall be conducted, documented, and passed prior to selection.

Test reports shall be submitted to document the suitability of material specifications for all locations subject to an APF cleaning program. Standard DRM details and materials may be utilized in other areas of the APF. Mockups shall be fabricated and tested as a system and incorporated into the construction of the facility.

## 13.6.1 Ceilings

APF ceiling design considerations shall include, but not be limited to:

**A. Structure:** Ceiling structures must be designed to resist sagging and deflection due to room pressure gradients, including pressure reversals, without damage to their supported finishes. Therefore, a rigid, self-supporting ceiling system directly attached to structure is preferred; suspension of structure by threaded rod is allowable; suspension of structure by hanger wire is disallowed for classified and non-classified areas within APFs.

**B. Systems:** Acceptable APF ceiling systems include:

1. **ISO 7 or better:**
  - a. Monolithic ceilings with high-performance finish systems are preferred in rooms with ISO level classifications of 7.

- b. Where monolithic systems cannot be provided (due to existing conditions, etc.) and suspended panel systems are selected, a panelized system composed of fiberglass reinforced polymer (FRP) or uPVC are preferred so long as the system is gasketed with hold down clips to create a fully sealed system.
- c. Monolithic composite panelized ceilings are preferred.
- d. Fully-sealed, cleanroom suspended tile system with cleanroom ceiling tiles gaskets and hold down clips are allowable.
- e. High-performance epoxy-coated drywall systems are allowable, but should be minimized to the extent practicable.

**2. ISO 8, CNC, and NC:**

- a. Monolithic composite panelized ceilings are preferred.
- b. Fully-sealed, cleanroom suspended tile system with cleanroom ceiling tiles are allowable.
- c. High-performance epoxy-coated drywall systems are allowable, but discouraged.

**C. Additional Design Considerations:** All APF ceilings shall be an integrated system with the walls, or shall have a flush, smooth sealed ceiling/wall joint. Acceptable materials/ systems shall be “smooth and impervious”, and:

**1. Monolithic composite FRP, uPVC and other moisture and chemical-resistant panel systems:**

- a. Panel system can either be walkable (preferred) or non-walkable (acceptable).
- b. Shall be adequately supported to prevent sagging and/or delamination under loads, including air pressure-driven deflection (hyper-negative/positive).
- c. Joints should be flush and smooth, and preferably batten-less.
- d. All components shall be tested for resistance to the cleaning materials and methods and as a system.

- e. Refer to [Section 4.4.5 Wall and Ceiling Finishes for Aseptic Facilities, BSL-3, ABSL-3, and Similar Facilities](#) for additional requirements.

**2. Cleanroom suspended tile systems shall meet or exceed the following criteria:**

- a. Designed and built per manufacturer’s requirements and recommendations for not less than one ISO classification level better than the design requirement of the room.
- b. Where accessible, suspended tile panel systems are used, provide heavy-duty corrosion-resistant, gasketed grid and hold-down clips that result in compression of the gasket around the entire perimeter of each panel. Hold-down clip design shall allow for panel removal without damage to the ceiling system in areas where utility access is required.
- c. All components shall be tested for resistance to the cleaning materials and methods and as a system.

**3. High-performance epoxy-coated drywall systems shall meet or exceed the following criteria:**

- a. Composition and thickness of coating systems are dictated by the functional requirements of the space they serve. Gypsum wallboard within an APF shall be specialized high impact moisture resistant systems appropriate for APF environments. Standard commercial systems are not acceptable. Consideration should be given to protecting gypsum wallboard partitions with abuse-resistant glass fiber reinforced finish system. A level 5 gypsum drywall finish system is not permitted.
- b. Total minimum wet-film thickness after substrate preparation shall be 0.25 mm (10 mils), but not less than manufacturer’s recommendations for the specific application.
- c. Dry film thicknesses are difficult to ascertain, so DTR prefers recorded wet film thicknesses during installation, per

ASTM D4414 – 95 Standard Practice for Measurement of Wet Film Thickness by Notch Gages.

- d. Substrate shall have a noncombustible (fire-rated, Type-X, where required), moisture and mold-resistant core; and shall have a moisture resistant fiberglass mat faces, or similar.
- e. All components shall be tested for resistance to the cleaning materials and methods and as a system.

**D. Access Panels/Doors:** Access panels must be minimized within aseptic facilities. MEP systems shall be specifically designed to locate all items requiring maintenance, service, and adjustment outside of the facility perimeter to the greatest extent practicable. The number of access panels should be minimized; a single, larger panel is preferred to multiple small panels.

If access doors must be located in an APF they shall be flush stainless steel, fully welded, and gasketed. Access doors must have multi-point concealed latches, positively latch and provide an airtight, fully gasketed seal (watertight, where required by the application). See [Section 1.15.1 Common Engineering Requirements for Service Access and Service Access Panels](#).

Where required, access panels shall have the following characteristics:

1. Flush, fully welded and closed-cell gasketed stainless steel frames with concealed hinges are preferred.
2. Airtight/Watertight/Bubble-tight access doors are required within APFs.
3. Screwdriver operated cam latch is preferred; Key locking-type latches shall not be permitted.
4. Where required for pressurization, bubble-tight access panels shall be utilized.

**E. Sprinkler Heads:** The selection of sprinkler heads shall take the cleaning process/protocol into consideration and vice versa. Concealed, flush-mounted sprinkler heads are preferred (the cleaning SOP, shall consider and address the potential for buildup of cleaning residue between the cover and ceiling).

**F. Ceiling Penetrations:** Light fixtures, HVAC components, sensors, and other ceiling mounted devices must be sealed or gasketed to ceiling finish material. Piping, ductwork, electrical boxes, conduits, and other penetrating items shall be firmly anchored to resist movement that could damage seals.

**G. Ceiling-Wall Interface:** All finish transitions shall be smooth, flush and sealed. Radiused inside and outside corners are preferred for cleanability.

---

## 13.6.2 Walls

APF wall design considerations shall include, but not be limited to:

**A. Structural:** Wall construction shall be designed to provide the required strength to support the imposed loading and with sufficient stiffness, to minimize deflection and movement, and eliminate finish cracking and sealant failures. Wall construction and materials must be selected to ensure compatibility with finish systems, and to provide a smooth, void-free substrate. All seams and fasteners must be fully sealed, and the system adequately supported to prevent sagging, deflection or delamination. See [Section 4.3.2 Laboratory Partitions](#) for additional requirements.

**B. Materials:** Provide impact-resistant wall system, including protection and components. Following is a listing of finish materials for APF walls:

1. Monolithic composite panelized systems are preferred.
2. They shall be adequately supported to prevent sagging and/or delamination under loads, including air pressure-driven deflection due to hyper-negative/positive over-pressurization).
3. Joints shall be flush and smooth, and preferably batten-less.
4. All components shall be tested for resistance to the cleaning materials and methods and as a system.
5. Modular cleanroom wall systems are also preferred.



6. They shall be designed and built per manufacturer's requirements and recommendations for not less than one ISO classification level than the design requirement of the room (preferred).
7. They shall incorporate windows, doors, and other accessories, as required for a complete installation, including all accessories and rough-ins.
8. Primarily glazed cleanroom wall systems that are modular cleanroom wall systems are also preferred, but have special wall protection requirements (i.e., floor-mounted crash rails, etc.). These are additionally preferred due to enhanced observation and communication capacity.
9. High-performance epoxy-coated drywall systems are allowable, but not preferred (See [Section 13.6.1 Ceilings](#), high-performance epoxy-coated drywall systems for additional requirements).
10. Filled concrete/masonry/plaster surfaced with high-performance coatings are disallowed for APFs.

**C. Details:** Detailing requirements for APF walls include, but are not limited to:

1. The tops of hollow partitions shall be sealed to exclude pest infestation.
2. Walls shall be sealed to door frames, cover plates and all other openings and penetrations.
3. They shall be coved in the wall-ceiling, wall-wall, and wall-floor transitions to promote cleaning.

**D. Wall Penetrations:** Windows, doors, pass through chambers, HVAC components, sensors, and other wall mounted devices must be sealed or gasketed to wall finish material. Piping, ductwork, electrical boxes, conduits, and other penetrating items shall be firmly anchored to resist movement that could damage seals. All seams and fasteners must be fully gasketed and sealed.

**E. Wall Protection:** Wall finishes shall be protected from impact and wear; see [Section 13.6.5 Wall Accessories](#) for additional information.

**F. Wall-floor Interface:** All finish transitions shall be smooth, flush and sealed. An integral cove base is required to transition from the wall to the floor.

---

### 13.6.3 Doors & Hardware

Doors play a critical role in the overall design as they function to maintain pressurization and, prevent contamination. As in labs at NIH, pocket doors, bi-fold doors and accordion doors are not permitted in APF due to the crevices that are difficult to clean as well as issues related to pest management and maintaining control. Specialty doors such as automatic operating sliding doors may be allowed only if fully cleanable and do not promote dirt collection and require approval by the PO/COR, DFM and DTR/FCIS. High-quality doors, door frames and hardware are to be selected for high use due to durability, maintenance and operations issues. The following criteria are to be applied in the selection of doors and associated hardware.

#### A. Frames:

1. All door frames shall be fabricated from type 304 stainless steel or extruded aluminum.
2. Fully welded, mitered stainless steel or FRP frames are preferred.
3. New knock-down hollow metal (KDHM) frames, included welded, filled and ground, are disallowed in APFs.
4. Existing to remain (ETR) KDHM frames are discouraged in ISO classified areas for construction projects.
5. Frames should be flush with the adjacent walls to present as few horizontal surfaces as possible.
6. Frame shall be well anchored to minimize deflection/distortion, to avoid abrasion (particle generating).
7. Door frames shall accommodate replaceable, closed-cell bubble gaskets. Bristle sweeps are not permitted in APFs.

**B. Doors:**

1. Doors shall be designed and fabricated for cleanroom applications from stainless steel (low carbon), or FRP with half or full glass vision panels for high visibility.
2. Door panels shall be fully flush on all sides with no recesses or openings on any side. Top rails must be flat on top, not channel construction.
3. Doors should present as few horizontal surfaces as possible.
4. Doors, frames and hardware shall not create voids, crevices or cracks which require caulking.
5. Preferred cleanroom door slabs include:
  - a. Minimum 16 Ga., type 304 stainless steel, with a solid polyurethane core.
  - b. Minimum 3/8" thick (9.5mm), fully-glazed tempered glass with smooth-polished edges on all sides.
  - c. Seamless molded fiberglass, with solid polyurethane core.

**C. Door Hardware:**

1. All door hardware should be fabricated from type 304 stainless steel.
2. High load lift-off (pivot) hinges are preferred over knuckle hinges.
3. Handles and locks shall be smooth, non-snagging and cleanable.
4. Hardware, such as latches, locks, hinges, and door/frame interfaces shall be closely adjusted to minimize abrasion (particle generating).
5. Automatic door operators should be considered for hands-free operation, and if used, infrared motion detector activation is preferred over push plates.
6. Door position switches may be provided on doors monitored for differential pressure, and tied to the BAS for collecting door position data (for BAS alarm response and management).

7. Thresholds should be avoided to the extent practicable.
8. Provide sloped top shrouds for door closer power units, where the unit cannot be fully recessed into the wall.
9. Drop-down sweeps should be avoided in favor of solid, adjustable, fixed sweeps.
10. Bristle-type sweeps and astragals are prohibited inside APFs, but may be considered for perimeter doors.
11. Provide door plates.
12. Door systems shall be fully integrated with automatic openers, emergency egress overrides, door interlock systems, door status indicator lamps, door position switches, electrified mortises/mag-locks, etc. that are appropriate for the following characteristics:
  - a. Resistance to the cleaning materials and methods.
  - b. Ability to fully compress the bubble gasket and latch/unlatch and unseal through the entire range of motion, as designed, against the 2x the full design pressure differential and reversal of that condition.

**D. Door Configuration:**

1. Doors should be configured to open to the higher pressure-side where practicable, and/or provided with mechanical operators.
2. Where the design pressure on the door exceeds .04 in. w.c., a mechanical door operator shall be provided.
3. Doors in series, functioning as a vestibule or anteroom, shall be physically or operationally interlocked. Interlock function can be via electromagnetic locks, red light/green light indicators, or through other administrative controls, established by the users and documented in SOPs or, some combination of systems. The interlocking scheme shall be reviewed and approved during design.

**E. Doors in Series:** Particular to anterooms, but common in APFs, are the feature of doors in series. An NIH APF is not a place of public accommodation and is an access controlled area within a federal facility, so the Architectural Barriers Act Accessibility Standard (ABAAS) is the governing regulation for accessibility.

The ABAAS does not contemplate a condition where the doors are required by procedure or physical interlock to be incapable of simultaneous operation. NIH cannot grant a variance on the ABAAS requirements, and an Access Board waiver may be required where it is desired to treat this condition as conforming to ABAAS 404.2.6, or other interpretation which seeks to shorten this distance due to space constraints.

## 13.6.4 Windows

Exterior windows are not desirable within APFs and should be avoided, particularly in ISO classified spaces, due to the possibility of moisture migration as well as air infiltration and the resulting bioburden to the space. However interior windows are desirable within APFs for safety, visual inspection, aesthetics, and to provide borrowed light.

**A. Frames:** APF window frame considerations shall include, but not be limited to:

1. Fully flush, frameless stainless steel or FRP construction are preferred in ISO classified spaces
2. Knock-down frames including welded, filled and ground, are disallowed in APFs.
3. Glass stops and other components shall be integral with the frame, sealed or concealed.
4. Frame surface shall be sloped or otherwise detailed to eliminate horizontal surfaces. The perimeter of frames shall be flush with and sealed to adjacent wall finish for ease of cleaning as to prevent settling of dust.

## 13.6.5 Wall Accessories

In APFs, wall accessories include components affixed to the wall; made of durable materials; resistant to the cleaning chemicals, designed to minimize caulking while maintaining cleanability; and able to resist differential pressures without leakage. Caulking/sealing shall be done all-around wall accessories. See [Exhibit 13.6](#).

Within APF, non-classified areas, normal DRM compliant wall accessories may be provided, but it is recommended that these also comply with the stricter requirements listed here. The following requirements apply to all other areas within APFs.

**A. Crash/Bumper Rails:** Crash/bumper rails shall be heavy duty stainless steel (304 or 316 L); tubular style; floor or wall-mounted with countersunk/concealed and sealable fastening hardware (typically flat bar posts with circular baseplate); corners pre-formed; standards should suspend the rail not less than 76 mm (3 in.) off the face of the wall to facilitate cleaning all-around. Provide suitable structural backing to support mounting.

**B. Corner Guards:** Corner guards shall be heavy duty stainless steel (304 or 316 L); pre-formed to the angle of the outside corner; fully adhered using 2-part epoxy; full-height; and gapped 13 mm (½ in.) from other wall accessories to facilitate caulking all-around. The width can vary, depending on the location, but should be not less than 51 mm (2 in.).

**C. Scuff Plates:** Scuff plates are heavy wall protection plates that are fully adhered and sealed to the wall. They shall be heavy duty stainless steel (304 or 316 L) or FRP-type panel, not less than 1.905 mm (0.075 in.); fully adhered using 2-part epoxy, and gapped 13 mm (½ in.) from other wall accessories to facilitate caulking all-around. The width can vary, depending on the location, but should be not less than 152 mm (6 in.). The centerline of the mounting height shall align with the contact point of the carts, shelves, tables, etc. that are anticipated to impact the wall in these locations.

**D. Shelves and Standards:** APF shelving should be cart-mounted where practicable (furniture/cart shelving is preferred to wall-mounted for clean-ability). Where shelves and standards must be wall mounted, the standards shall be heavy duty stainless steel (304 or 316 L); mounted rails on stand-off shelf bracket supports that have an adjustable tubular standard suspended

between. Where KV-style brackets are necessitated, due to load considerations, they shall be provided with covers and closures to seal the ends of the standards as well as any unused holes in the standard. All shelves shall be heavy duty stainless steel (304 or 316 L), or epoxy-coated plated steel wire shelves. Provide suitable structural backing to support mounting.

**E. Cleanroom Clocks:** Cleanroom clocks shall be specially designed and manufactured for the cleanroom environment. The clocks shall be recess mounted; stainless steel (304 or 316 L). The clock features and color shall be selected by the facility owner. Clocks may be hard wired or battery powered (but not less than a 10 year battery).

**F. Cleanroom Telephones:** Cleanroom telephones shall be compatible with NIH telephone hardware requirements, and shall be designed and built for cleanroom applications, including oversized buttons, smooth and impervious front panel, and shall be water resistant.

**G. Fire Extinguisher Cabinet (FEC):** FECs shall be fabricated from stainless steel (304 or 316 L), with a frameless glass door. The cabinet shall be designed to install flush with the wall in a prepared cavity.

**H. PPE Dispensers (Built-In):** Shall be fabricated from stainless steel (304 or 316 L), or other compatible material. Provide suitable structural backing to support mounting.

**I. Signage:** All APF signage shall be non-permeable, non-shedding, cleanable and resistant to regular exposure to cleaning chemicals and processes without degradation. All surfaces should be “smooth, impervious, free from cracks and crevices, and non-shedding”.

APF signage should be formed from a single reinforced plastic or aluminum blank, fully adhered and caulked to the wall (not door), per the Architectural Barriers Act Accessibility Standard (ABAAS) guidelines. Sign headers and colors on safety signs shall comply with OSHA and ANSI specifications to designate the severity of the hazard. Signs that are pre-drilled for mechanical fasteners should be avoided in favor of continuous sign blanks, fully-adhered. ABAAS-required braille and raised numbers should be considered exempt from the “smooth” requirement (e.g., braille and raised lettering is allowed).

Paper-based certification labels on equipment, such as BSC certifications are prohibited in APF areas. Debossable aluminum self-adhesive labels are the preferred solution to this issue.

**J. Pass Through Chambers:** Pass through boxes/chambers/cabinets shall be used where material (or carts with or without materials, in the case of cart pass-through chambers) must transit between rooms of differing risk, classification, and/or differential pressure in order to reduce the risk of contamination. Pass through assemblies shall be constructed of welded stainless steel; flanges and mounting brackets are necessary for a flush, sealed installation in the wall. Doors shall be interlocked, positively latched, and gasketed to provide an air-tight seal and maintain pressure differentials, and should have full lite glass doors for visibility.

All pass through chambers in APFs shall be active. See [Section 13.8.9 Airlocks](#) for additional information.

Cart pass through chambers must be sized to accommodate the largest anticipated cart, including the cart’s anticipated load. Material pass through chambers must be sized to accommodate the largest anticipated containers but shall not be less than 460 mm x 460 mm x 460 mm (18 in. x 18 in. x 18 in.) and shall be structured to support no less than 23 kg (50 lb.).

Floor flatness at and around cart pass through chambers (i.e. extending not less than 2x the door swing for existing facility renovation projects) must be adequate to create and maintain pressurization between the seal and the floor. See [Section 13.7.2 Floor Flatness](#) for additional information on floor flatness requirements.

**K. Other Accessories:** Other accessories shall be of appropriate materials suitable for the APF environment. Interface points to the wall shall be caulked to eliminate gaps, cracks, and edges. Where practicable, the accessories shall be installed flush with the surface of the wall. The wall should be bumped out as required to facilitate this condition. Large accessories should be flashed to the wall with not less than 51 mm (2 in.) wide stainless steel flashing. Accessories that are not flush should be gapped from perpendicular wall surfaces not less than 305 mm (1 ft.) to facilitate cleaning. Where this spacing is not achievable, instead minimize the gap and bridge the resulting/remaining gap with not less than 51 mm (2 in.) wide stainless steel flashing.

### 13.6.6 Floors

Finished flooring in the APF shall be monolithic and seamless with integral cove base (152 mm [6 in.] minimum height) and shall be extended wall-to-wall, including under equipment and casework systems. It shall also have radiused inside corners. Transitions of flooring with the wall, door frames, and all other elements shall be smooth, flush and sealed. All transitions shall be detailed in the drawings.

The following criteria shall be taken into consideration for APF flooring design.

**A. Structure:** Floor construction shall be level and adequately strong to support the anticipated loads without deflection, cracking or movement. Floors, including finishes, shall be capable of withstanding impacts and heavy wheeled traffic without damage.

**B. Floor Preparation:** Prior to installation of the finish system, the manufacturer must inspect the floor and certify that all required conditions for the finished floor installation have been met.

**C. Materials:** Finish flooring material shall be selected based on cleanability, level of traffic (foot and wheeled), loading, use of cryogenics and resistance to chemicals and disinfection agents. Selection of floor finish shall take into consideration shoe covers worn by the user, as part of the gowning process, to ensure that selected finish has sufficient slip resistance. To the extent practicable, the same flooring material should be used throughout the APF, including classified and non-classified areas. Acceptable finish materials for APF floors include, but are not limited to:

1. Welded seamless sheet vinyl:
  - a. The sheet vinyl cleanroom flooring system shall be designed and installed per manufacturer's requirements and recommendations for not less than one ISO classification level than the design requirement of the room (preferred).
  - b. Sheet vinyl shall be heavy-duty, commercial cleanroom grade, non-porous, abrasion resistant, easy to clean, resistant to damage under both static and dynamic loads.
2. Cold-Welded Rubber:
  - a. Cold-welded rubber sheet cleanroom flooring systems shall be designed and installed per manufacturer's requirements and recommendations for not less than one ISO classification level than the design requirement of the room (preferred).
  - b. Sheet rubber shall be heavy-duty, commercial cleanroom grade, non-porous, abrasion resistant, easy to clean, resistant to damage under both static and dynamic loads.
  - c. User group shall provide electrostatic characteristics during design (if applicable).
  - d. All components shall be tested for resistance to the cleaning materials and methods and as a system.
  - e. Use of factory formed, reinforced inside and outside cove corners is preferred, top form an integral cove base.
3. High-Performance Resinous Coatings:
  - a. High-performance resinous coating flooring systems, typically urethane-based, shall be designed and installed per manufacturer's requirements and recommendations for not less than one ISO classification level than the design requirement of the room (preferred).
  - b. High-performance resinous coating flooring systems are allowed, but not preferred.



- c. Careful attention shall be paid to friction-enhancing components to reduce slips and falls, to avoid creating conditions that damage cleaning mops, or impair thorough cleaning.

4. **Other Flooring Materials:**

- a. Vinyl composition tile (VCT), raised access flooring, and other non-monolithic flooring systems are not appropriate for the APF environment.

**D. Line Of Demarcation (LOD):** These are lines/markings on the floors that indicate step-over lines, cart excursions at cart pass throughs and other administrative controls that limit the range of movement allowable in areas within an indicated area of the APF. There is a range of options available for permanent marking of these lines:

1. **Change in Floor Material Color:** This should only be utilized where there is a high level of confidence that the LOD will remain fixed for a long time, especially for epoxy-type flooring.
2. **Inset Lines:** Preferred method, based on impact to change, and maintenance impacts.
3. **Floor Marking Tape:** This is the most flexible approach where the program is subject to change, however, it poses the highest risk of failure due to adhesion issues, or difficult to maintain. Mockup testing is therefore essential prior to deploying a tape solution.

## 13.6.7 Furnishings

Moveable, cleanroom specific furniture should be used in lieu of built-in, wherever possible. Items should be easily removable or moveable for flexibility and, to allow for cleaning and decontamination.

If built-in items are required, they shall be cleanroom specific, sealed to the wall and floor (where allowed by regulation) and be welded stainless steel or other APF-appropriate seamless material that can withstand the cleaning regimen of the facility.

## 13.6.8 High-Performance Coatings

The composition and thickness of coating systems in APFs are dictated by the functional requirements of the space it serves. High-performance reinforced multi-coat resinous paint finish on anti-microbial and mold-resistant gypsum board may be considered when there are functional advantages over modular, panelized systems and if approved by ORF and the program. In the APF, high-performance coatings on masonry and other surfaces which are not impervious, flat and smooth are not permitted.

**A. Testing/Mock-Ups:** Where epoxy paint and other specialized high-performance coatings are selected as floor, ceiling or wall finish, selected system and surface finish coating shall have been verified for compatibility with the cleaning chemicals identified by the program, for use in the facility. When data is not available and/or is questioned, coupon testing of selected finish and/or mockup with finish product shall be tested to ensure compatibility.

The following requirements are in addition to the manufacturer's installation requirements.

1. **Installer Qualifications:** Coating applicators shall be minimum Society for Protective Coatings (SSPC) Coating Application Specialist (CAS) Level II Certified, and must be trained and approved by the coating system manufacturer for the application of the specified products and techniques, required for the application of products per the manufacturer's recommendations and requirements.
2. **Independent Inspection:** All high-performance resinous coating system applications must be inspected by an independent third-party Coating Inspector Program (CIP) level-III certified inspector (approved similar qualifications may be considered) throughout the preparation and installation. The inspector shall then prepare and submit a detailed report on the installation.



### 13.6.9 Modular Components

Modular wall and ceiling panelized systems provide significant performance advantages over stick-built and coated systems, including uniformity, high resistance to degradation, and incorporation of cleanroom detailing.

**A. Wall and Ceiling Panels:** Pre-engineered wall and ceiling panels constructed of Fiber-Reinforced Plastic (FRP), Chlorinated Polyvinyl Chloride (CPVC), High Density Polyethylene (HDPE) with polyester gel coat, or other material that has been tested to demonstrate non-shedding, cleanable, and resistant to regular exposure to cleaning chemicals and processes without degradation properties. The panels shall be tested and certified to meet or exceed the ISO cleanliness of the room in which it is to be installed, per ISO 14644-1. The system shall not outgas post installation.

Surface finishes shall not be selected based on first-cost, but on the life-cycle cost basis for the facility. Systems shall be impact resistant and shall have smooth, sealed joints and transitions, eased outside corners and coved inside corners.

All materials shall resist damage due to exposure to cleaning materials and methods, heat, humidity, and other abuse that will reasonably be anticipated to be encountered in the life cycle of the facility, without degradation below minimum service level for the application.

All finish material selections shall exhibit mold and mildew resistance properties. Products shall be installed over cellulose-free (inorganic-faced) substrates only.

Provide impact-resistant wall system, including protection and components.

The joint systems should be batten-less, with concealed fasteners, and coved at all inside corners, including wall-wall, and wall-ceiling joints. All joints should be filled, smooth and continuous with equal or better resistance to degradation than the field panels (i.e., chemically welded). The finish of modular panels should be smooth, glossy, and white. The panels should be the largest size practicable. All wall-wall and wall-ceiling interfaces should be coved with pre-manufactured components designed for that purpose. All wall-floor interfaces should be coved utilizing the flooring system and terminated to the wall panels with a smooth, cleanable condition that does not create a horizontal surface.

Panelized composite wall and ceiling systems are preferred due to their controlled-environment manufacturing, design versatility, chemical resistance, pressure/airflow resistance, and pre-engineered details. Selected panel systems shall be resistant to the chemicals listed in the Cleaning and Sanitizing SOP for the APF.

Installation must be by certified installers. Substrate material and detailing must be inspected and certified as acceptable by the manufacturer. Adhesives, sealants and all other system components must be as chemical resistant as system panels. Panel Systems shall be Class "A" Fire Rated both as a composite assembly and for the surface alone.

Mechanical, Plumbing, Process Piping, Electrical Power, Electrical Low-Voltage, and other systems should be integrated into wall and cavity spaces behind the panels using metal stud framework. Integrated openings, such as for service panels, fire extinguisher cabinets, etc. should be planned and detailed to ensure continuity of the room envelope. Wall protection should consist of stainless steel corner guards and scuff plates, fully adhered to the wall panels, gapped 13 mm (½ in.) and caulked.

Modular panelized ceiling systems may be fully adhered to a structural joist system, suspended by clips to a threaded rod hanger, or a specially designed, gasketed, cleanroom lay-in ceiling grid, suspended by threaded rods from the structure above. Cable supported ceiling structures are not permissible in APFs.

**B. Windows:** The interior windows should be provided as part of the modular panel system to the extent practicable. There should be no exterior windows in APFs. These components should integrate with the wall system such that they produce a completely flush condition, without horizontal ledges or joints.

Generally windows will be the full depth of the wall to create flush surfaces on each side of the wall, and should be hermetically sealed and include a desiccant or other means to prevent condensation within the window unit. All windows in APFs should be tempered.

**C. Doors, Frames & Hardware:** The door systems should be specialty cleanroom doors, smooth, easy to clean, non-shedding, non-porous, resistant to microbial growth, and resistant to regular exposure to cleaning chemicals and processes without degradation. Except

where precluded by the program, all interior APF doors should have half-lites or larger to promote visual communication and safety.

### 13.6.10 Caulks and Sealants

For APF projects, all joints, gaps, seams, penetrations and voids in and within the facility, shall be completely sealed, forming a continuous monolithic and impermeable infiltration barrier, to enhance sanitation, facilitate gas and/or vapor decontamination, and maintain pressure differentials. APF sealant requirements are different from other project types, as described in the, see [Exhibit 13.6](#) for the APF sealant table. Other areas that require sealant include:

1. All fixtures, furniture, and devices (including fixed equipment, casework, shelving systems, mechanical and electrical devices) shall be completely sealed, including, but not limited to, all conditions listed in the Sealant Table.
2. All penetrations into, and through partitions, floors, and ceilings, listed in the Sealant Table, shall be in addition to, and not a substitute for, rated sealants.

**A. Sealant Selection:** Confirm compatibility between sealants and the material to which they are applied. Sealant must have chemical resistance, flexibility, durability, adherence, mold resistance and other characteristics appropriate for its use. Opaque sealant shall be utilized to verify full coverage and highlight imperfections in application.

**B. Sealant Types:** All sealant used in the APF shall be 100% silicone (i.e., JS-5 100% Silicone ASTM C920) and mildew resistant. Use aluminum finish silicone sealant when sealing stainless steel equipment, fixtures and assemblies.

Stainless steel to stainless steel joints shall be sealed with clear silicone. All other joints shall be white silicone.

**C. Sealant Installation:** Sealant shall be applied in accordance with the manufacturer's requirements and recommendations, without drips or excessive material, uniform, smooth, and continuous manner, resulting in a finish free of voids, pinholes, sharp edges, or excess

sealant. Sealant must be full coverage, without gaps or voids.

Sealant must be compatible with all material that it is in contact with, including other sealants. Previously sealed items shall be cleaned of old sealant and properly prepared for resealing.

Sealant shall not adversely impact the operation of sprinklers or other devices. All items shall be firmly anchored, and wall and ceiling construction designed to resist movement that could damage seals.

#### D. Sealant Details:

1. All joints between materials and systems will be flush wherever possible and will be gasketed and/or sealed.
2. Penetrations shall be visible for inspection and maintenance.
3. Penetrations in rated assemblies shall be appropriately UL listed and approved by the DFM. Finish sealants, listed in the sealant table, shall be in addition to, and not a substitute for, rated sealants. Seams between walls, floors, and ceilings, and between all dissimilar materials shall be fully sealed. Sealant at movement joints shall be applied after installation of finishes to resist cracking.
4. Where escutcheons are provided, they shall consist only of a flat, non-corrosive plate, free of concealed or inaccessible voids, fully embedded in sealant and completely sealed to the penetrating item.

**E. Sealant Installation Execution Plan:** The Sealant installation execution plan shall be provided and approved by the PO/COR, DTR/FCIS, DTR and the ORSC, OD prior to installation. The Execution Plan shall indicate the responsible party for installing all sealants, including their experience and qualifications.

**F. Sealant Mock-Up:** The sealant mock-up shall be constructed for approval of the PO/COR, Pest Management Representative and DTR/FCIS. The mock-up shall include all typical conditions and materials, and shall remain in place as a basis of comparison and approval of the final installation.

### 13.6.11 Mock-ups

Mock-ups are required for all aseptic facility projects. The mock-ups shall be constructed with the same conditions, using the same materials and techniques as the final installation. Mock-ups shall include sections of all finish materials and systems (coatings, floor, wall and ceiling finishes, sealants, door frames, access panels, cover plates, wall protection, etc.), in all typical conditions (inside and outside corners, base/wall junction, wall/ceiling junction, wall and ceiling-mounted devices, etc.). Mock-ups shall be approved by the PO/COR, program personnel, DTR and other stakeholders, and shall be maintained as a reference for the minimum level of acceptable quality and workmanship.

Mock-ups may be used for chemical and other testing if required performance records for materials are not available, or deemed necessary for facility users or DTR.

### 13.6.12 Finish Cleaning Schedule

The construction contractor shall furnish a table of all finishes, including caulks and sealants, potentially exposed to cleaning. This table shall be predicated on a triple clean (meaning sequential cleanings with germicidal detergent, sporicidal, phenolic disinfectant, hydrogen peroxide and/or other oxidizing cleaners). The table should describe the various manufacturer's minimum curing schedule prior to exposure to the site-specific triple cleaning protocol.

# Section 13.7

## APF Design Requirements: Structural

---

### Contents

13.7.0 Introduction

13.7.1 Structural Capacities

13.7.2 Floor Flatness

13.7.3 Vibration Control

## 13.7.0 Introduction

Structural design is crucial to the performance of an APF. Critical assessment of proposed structural framing should reflect current planned as well as future needs. The Office of Research Services (ORS), Division of Physical Security Management (DPSM) may provide additional structural requirements, including, but not limited to progressive collapse and hardening. See [Section 5.2.1 Loads](#).

Perform early planning and coordination with the entire design team. The PO/COR shall ensure that the structural engineer learns the needs of all disciplines, resolves issues, and develops a multi-discipline-coordinated structural system.

4. Wind Loads: See [Section 5.4.5 Loads](#). Additionally, tie-downs or their equivalent shall be provided sufficient to resist uplift and overturning force(s).

### B. Dead Loads:

1. The APF shall be designed to support the actual weights of all materials. These include structural materials, finishes, ceilings, partitions, shielding, electrical wiring and conduits, piping, and ductwork.
2. Assumed weights shall be indicated on the design documents.
3. See [Section 5.2 Structural Loads and Demands](#) for additional structural load requirements.

## 13.7.1 Structural Capacities

The total weights of APF trailers and modular buildings shall be transferred to supporting structures, within the live load capacity of the supporting structural framing. APFs shall not be subject to live load reduction.

### A. Live Loads:

1. The general live load capacity of a new APF floor shall be not less than 6 kPa (125 PSF).
2. Walkable ceiling, with light traffic only (i.e. changing filters, lamps, and similar light work) = 1.0 kPa (20 PSF).
3. Snow Loads: See [Section 5.4.5 Loads](#).

## 13.7.2 Floor Flatness

APF Design documents shall specify minimum floor flatness and floor levelness tolerances when the installations of finish materials, functional conditions, or equipment dictate tight control of concrete slab substrates. This is of particular importance where cart pass throughs are utilized, due to their required seal to, and door swing interactions with the floor surface.

Avoid raised thresholds, steps, or ramps in corridors and other areas used for material transport to the extent practicable.

See [Table 13.7.2](#) for a summary of these requirements.

**Table 13.7.2 Recommended Floor Flatness**

*Minimum Recommended F numbers for APF Floor Profile Categories:*

Area	Character	Random Traffic Floor				Defined Traffic Floor
		Specified Overall Value		Minimum Local Value		
		F <sub>F</sub>	F <sub>L</sub>	F <sub>F</sub>	F <sub>L</sub>	F <sub>MIN</sub>
Critical APF Areas	Flat	50	33	25	17	50
General APF Areas	Good	38	25	19	13	38

### **13.7.3 Vibration Control**

The structural system shall be stiff to the extent that any transmitted vibration occurs at high frequencies, as high frequencies can be dampened with instrumentation vibration dampening systems and isolation tables rather than vibrations occurring at lower frequencies. The recommended floor vibration velocity limits of a modular system APF is 100 ( $\mu\text{m/s}$ ) and 3,200 Kipps/In-S.

See [Section 5.2.2 Vibration](#) and [Section 6.5.4 Ductwork and Fan Sound Control](#).



# Section 13.8

## APF Design Requirements: HVAC

---

### Contents

- 13.8.0 Introduction
- 13.8.1 Cleanroom Classification System
- 13.8.2 Outdoor Design Conditions
- 13.8.3 Indoor Design Conditions
- 13.8.4 Dedicated HVAC Systems
- 13.8.5 Redundancy
- 13.8.6 Ventilation Criteria
- 13.8.7 Air Change Rate
- 13.8.8 Pressurization
- 13.8.9 Airlocks
- 13.8.10 Air Distribution System
- 13.8.11 Air Handling Capacity
- 13.8.12 Ductwork Design
- 13.8.13 Air Intake/Exhaust
- 13.8.14 Air Handling Units (AHU)
- 13.8.15 Air Filtration
- 13.8.16 Exhaust Air Systems
- 13.8.17 Humidification System
- 13.8.18 Chilled Water Systems
- 13.8.19 Heating Water Systems
- 13.8.20 Steam System
- 13.8.21 Piping
- 13.8.22 Service Access Panels, Mechanical Spaces and Maintenance Consideration
- 13.8.23 Emergency Electrical Power
- 13.8.24 Equipment, Ductwork, and Piping Identification

## 13.8.0 Introduction

The purpose of Heating, Ventilation and Air Conditioning (HVAC) in APFs is to provide safe and effective products to the patients, provide personnel comfort, and protect both workers inside and the environment outside the facility from airborne materials that could be hazardous.

This is achieved when these systems are appropriately designed, built, commissioned, qualified, operated and maintained. The most important HVAC parameters for the APFs include airborne particles (filtration), temperature, humidity, and pressure differential. The HVAC requirements addressed this section are in addition to [Chapter 6: Mechanical Design](#).

## 13.8.1 Cleanroom Classification System

The concentration of total airborne particles and microbial contamination within the space is a key indicator of the room environmental conditions for Pharmacy and Biologics facilities. This target maximum is referred to as “classification” of the space.

Several classification systems exist for the classification of space. FDA follows ISO 14644 standard for assigning ISO levels (5, 7 and 8), but provides values only in-use and adds bio-burdens values for each ISO class. Other systems such as the European Union (EU) uses the term Grade followed by A, B, C and D. For example, ISO 7 looks similar to Grade B, but the EU standard also has at-rest limits. See [Table 13.8.1](#).

**Table 13.8.1 Cleanroom Classification Table**

ISPE GRADE	FDA - IN OPERATION		PIC/S GRADE	EU AND PIC/S				ACTIVE AIR ACTION LIMITS (cfu /m <sup>3</sup> )
	ISO	USP 0.5 MICRON PARTICLES/ CU FT		IN OPERATION LIMIT (particles/m <sup>3</sup> )		AT REST LIMIT (particles/m <sup>3</sup> )		
				≥0.5μ	≥5.0μ	≥5.0μ	≥5.0μ	
Grade 5	ISO5	100	A	3,520	20	3,520	20	1
Grade 6	ISO6	1,000	N/A	35,200	290	3,520	29	7
Grade 7	ISO7	10,000	B	352,000	2,900	3,520	29	10
Grade 8	ISO8	100,000	C	3,520,000	29,000	352,000	2,900	100
CNC+	N/A	N/A	D	N/A	N/A	3,520,000	29,000	200
CNC	N/A	N/A	N/A	N/A	N/A	N/A	N/A	N/A
UC	N/A	N/A	N/A	N/A	N/A	N/A	N/A	N/A

### Notes:

1. Values may be averages; EU and PIC/S require measurement of particles up to and including 0.5 micron and 5 micron; the US require 0.5 micron, hence the table incorporates both to ensure compliance with the most stringent requirement.
2. Samples from Grade 5 areas should normally show no viable organisms.
3. Recovery from the “In Operation” to the “At Rest” state should be verified to occur within 15-20 minutes for ISPE grades 6, 7 and 8. The recovery test as defined in ISO 14644-3 may be carried out to verify a one or two log reduction test. Recovery testing may also be performed for informational purposes.
4. “At Rest” figures are given to support Recovery and “Static” Room Classification testing. Maintenance of these Levels during idle (not in use) periods is not intended.

## 13.8.2 Outdoor Design Conditions

The outdoor design conditions for Bethesda shall be per Section 6.1.7 and Table 6.1.7.

## 13.8.3 Indoor Design Conditions

Room temperature and humidity requirements depend on process, equipment, material and product requirements, and operator comfort.

Personnel in the space produce fewer particles when comfortable. Also, high humidity increases microbial and mold growth on surfaces.

The compounding pharmacy USP regulations, require room temperature to not exceed 20°C (68°F) and room humidity to not exceed 60% RH. For NIH APFs, pharmacy compounding room temperature shall be designed to between 18 and 19°C (64.4-66.2°F) for classified rooms (with room temperature not to exceed 20°C [68°F]) based on the gowning requirements and type of work being performed. Also, the room humidity shall be designed between the 50% and 55% RH for the classified areas during summer months with room humidity not to exceed 60% RH. During winter, the minimum room humidity shall be designed to 25% RH. The A/E shall consult with User and DTR/FCIS prior to design.

In GMP, when human comfort is the only requirement, temperature shall be designed between 18.3 to 20°C (65 to 68°F) for classified rooms based on the gowning requirements and type of work being performed. Also, the room humidity shall be designed between the 50% and 55% RH for the classified areas during summer months while holding the room below 60% RH. During winter, the minimum room humidity shall be designed to 25% RH. The A/E shall consult with User and DTR prior to design.

For CNC spaces, the design temperature may be slightly higher than classified spaces. A/E shall consult with user for indoor design requirements.

## 13.8.4 Dedicated HVAC Systems

Dedicated air handling systems (including exhaust system) are recommended to serve the APFs and to maintain room environmental conditions including space pressurization at all times, even during non-working hours. This segregation should be extended to other systems including chilled water pumps, reheat systems, pre-heat systems, humidification, heat exchangers and controls to the extent feasible.

## 13.8.5 Redundancy

Provide minimum n+1 redundancy for AHUs, exhaust fans, pumps, heat exchangers, chillers and boilers serving APFs. APF systems are designed to operate 24 hours/day, 7 days/week. Redundancy allows systems to be properly serviced and maintained and work as backup during emergencies.

## 13.8.6 Ventilation Criteria

Unlike laboratories and animal facilities which require 100% outside air (OA), APFs do not require 100% OA, unless potent or hazardous compounds are to be used. Through a process of risk assessment and user requirements, the A/E shall determine if 100% OA or recirculating systems are appropriate and propose a system early in the design phase for NIH review and approval. NIH may choose to elect a 100% OA system based on multiple factors, including varied types of products, the unique population of patients that are served by these products, and the risks of contamination and cross-contamination during operation and changeover. If multi-recirculated units are used in classified spaces, return from these spaces shall not be recirculated in areas where there is risk of cross-contamination.

Due to large ACH requirements for the classified spaces compared to typical laboratory and animal facilities, 100% OA systems for APF, pose significant spatial, utility and energy requirements, including the risk of freeze ups, all of which should be carefully evaluated early in design.

In support areas, the minimum OA shall be in conformance with ASHRAE 62.1 or, as necessary to maintain pressure relationships.

### 13.8.7 Air Change Rate

In GMP, there is a common understanding of a minimum 20 ACH in classified spaces. The Compounding Pharmacy USP regulations require a minimum of 30 ACH for ISO 7 spaces. Pharmacy non-sterile hazardous rooms and hazardous drug storage rooms require a minimum of 12 ACH per USP regulations. Setting actual air change rates in classified spaces is complex and includes multiple factors such as:

5. Ability of the room to maintain and recover the airborne particle counts from an upset condition according to the room classification system
6. Number of occupants
7. Tasks they are doing
8. Donning/doffing PPE (and the type/level of PPE)
9. The delivery of supply air, including means, efficiency, and coverage
10. Heat and moisture gain from internal and external influences
11. Process and its particle generation rate
12. Cleanliness of supply air
13. Airflow required to achieve required Differential Pressures (dPs)

The higher the ACH, the higher is the recovery of the room from in-use to at rest. Also, viable particles are fewer in number than non-viable, but they travel with the non-viable, therefore controlling non-viable is critical. Setting arbitrarily high air changes rates can have significant cost implications although they may improve particle counts in the room.

At NIH, the following room air change rates (air changes per hour-ACH) shall be applied for APFs in order to maintain the desired room cleanliness classification.

Particle dilution calculations shall be used to determine air supply rate (or ACH) to ensure it meets the maximum airborne contaminations specified for its ISO class. The calculation shall be based on particle dispersion rate at steady state and concentration over time. This includes using the effect of the combination of filters and their removal efficiency on the make-up air, leakage rate, rate of particles emitted from equipment, rate of particles generated from cleanroom personnel and type of gowning used. The calculation shall be based on concentration of particles equal to 0.5 micron. Particle tracking using Computational Fluid Dynamics (CFD) to predict particle transport in an enclosed space is not cost-effective. CFD may be used for evaluating air flow velocity, volume, and temperature uniformity, recovery test as well as room pressurization in transient (as use) state. The ACH rate is typically based on supply air (first air) to the room.

1. ISO 7 spaces - 40 ACH minimum
2. ISO 8 spaces – 24 ACH minimum
3. CNC spaces – 12 ACH minimum
4. Non-Classified Spaces – 6 ACH minimum

Recirculated BSCs may be used to dilute airborne particles in the room and may accelerate the recovery time of the room. The airflow from the hood may not be included in the air change calculation rate because the added dilution only affects the area near the BSC's airflow path, not the entire room. The benefit of having recirculated HEPA is limited to improve the room recovery time.

### 13.8.8 Pressurization

Room relative pressurization is critical in controlling the migration of contaminants. The air distribution systems are designed to attain desirable pressure level within each room relative to all adjacent areas. The A/E shall establish a pressurization scheme early in design so it can be integrated with the architectural features of the facility. Door swings, type of doors, door gaskets, wall openings, and pass throughs all factor into the design of the pressurization system.

In general, directional airflow will be the targeted design criteria, with airflow cascading from clean to less clean areas with design differential pressures between adjacent spaces with the same ISO classification and shall be 10 Pa (0.04 in w.g), but not less than 7.5 Pa (0.03 in w.g.) and between 10 (0.04 in w.g.) and 15 Pa (0.06 in wg) for adjacent spaces with different ISO classification.

In a cleanroom, the processing suite is typically at the highest pressure relative to outside corridor and so it is important that each space is evaluated against relative pressure to outside corridor or to an alternate reference location such as interstitial space to make sure pressure differential across doors is not set too low or is too excessive. Differential pressures of greater than 25 Pa (0.1 in. w.g.) can cause difficulty in opening or closing doors against pressure and whistling through the cracks. Pressurization values on plans shall be shown both as represented "across the door" and "in relation to common reference point".

All cleanrooms shall remain positive to adjacent areas. Exceptions include:

1. Hazardous Drug (HD) sterile and non-sterile preparation rooms
2. HD Drug storage rooms (some conditions, such as oral solid dosage storage may require local exhaust vents (LEVs)
3. Radiopharmacy buffer rooms for compounding pharmacies
4. Infectious or viral vector rooms in Cell Processing suites

These “exceptional” rooms shall be negative to the entry airlock, but positive to the exit airlock in a uni-directional layout. Entry airlocks should be designed as “bubbles” and exits as “sinks”. See [Section 13.8.9 Airlocks](#).

Where recirculating systems are used, central AHUs shall be sized to provide outside air to maintain the space pressurization and to provide the makeup air to support exhaust requirements in the space.

Pressurization of the rooms will be maintained via primary air, delivered to each room via a constant volume terminal unit with reheat.

The A/E shall evaluate the following types of pressurization control including active pressurization control (direct pressure control systems shall not be used):

1. Flow tracking control with fixed user selectable offset
2. Cascade flow tracking control with pressure based reset of offset

Space pressure differential will be actively controlled through the Building Automation System (BAS), and airflow control devices will be provided on the supply air inlet to, and exhaust/return air outlet from, each space. Differential pressure transmitters for all rooms will be mounted outside the classified room or outside the cGMP area in a central panel. Space pressurization, supply airflow and door open duration (where feasible) will be recorded and alarmed via BAS. This system will also record any additional identified Critical Process Parameters in the HVAC system. Room pressurization shall not be affected by the energizing or de-energizing of central AHUs or terminal units or recirculation units.

Pressurization will be also be monitored via a validated Environmental Monitoring (EM) system.

---

### 13.8.9 Airlocks

Airlocks are designed to effectively control airborne contamination between rooms of different classification. Airlocks maintain pressure differential and integrity of the controlled space during entry and exit. If there is no airlock, room differential pressure (dP) will drop to near zero when the door is opened. Donning and doffing PPE generates large numbers of particles in the small volume of the airlock, therefore these spaces should be highly ventilated (above the ISO class ACH minimums) to allow for quick recovery and flushing.

Airlocks are required between ISO 7 and ISO 8 spaces and recommended between ISO 8 and lower class spaces (CNC or unclassified). There are three kinds of airlocks:

1. **Cascade:** Airflows from high pressure to lower pressure through airlocks
2. **Bubble:** Airlock is higher pressure than/to adjoining rooms

3. **Sink:** Airlock is at negative pressure then/to adjacent areas

The determination of whether the airlocks are “bubbles”, “sinks”, or “cascades” will be based on the specific activities taking place within the relevant/connected spaces.

For pharmacy rooms, all entry to sterile non-hazardous areas will be designed with “cascading” type airlocks. All entries to sterile hazardous and radiopharmacy rooms shall be designed as “bubble” type airlocks with the same ISO classification as the processing room to provide both cleanliness and containment. If there are exit airlocks in the layout, then the exit airlocks can be designed as “sinks” with lower ISO classification to the processing room.

In a fully unidirectional flow APF (material and people), the airlocks entering the processing suites shall be “bubble”, (i.e., positively pressurized with respect to both the supply corridor and the suite), and the airlocks exiting the hazardous areas shall be “sink”, (i.e., negatively pressurized with respect to both the suite and the return corridor). The “sink” airlock at the room exits will protect the processing areas from the dirty return corridor, and will protect the return corridor from contamination.

Supply and return corridors shall be separate from airlocks for entry or exiting the processing suites.

Gowning entrances to suites designed as “bubble” will help maintain the cleanliness of the personnel gowning step taking place by ensuring that air from the corridor and the processing suite is inhibited from entering the airlock.

The airlocks will be designed with administrative or engineering controls (i.e., physical interlocks) to prevent doors on either side of an airlock being opened simultaneously. Clear, unobstructed lites in both doors shall be considered to provide a line of sight view. Red/green indicator lamps are highly recommended to show when both doors are adequately sealed. A time delay may be considered to extend the time from the door position switches indicating the doors are in the closed-position before indicating a green light (i.e., “Go”) condition, to allow for greater recovery time of the anteroom.

Airlocks shall have their own dedicated supply and exhaust/return outlets and terminal units. Supply is

typically entered “high” at the clean end and exhaust/return, “low” at the dirty end.

A material pass through chamber is a type of airlock designed for the transfer of materials between rooms of differing risk, classification, and/or differential pressure in order to reduce the risk of contamination. A cart pass through chamber is installed at the floor level. All pass through chambers in classified spaces shall be active, and the type of pass through chamber selected (i.e. supply air only, exhaust air only, supply and exhaust air, or HEPA-filtered recirculating) shall be approved by DTR/FCIS. Passive pass through chambers shall not be allowed unless otherwise approved by NIH and supported by risk analysis.

HEPA-filtered recirculating pass through chambers shall both intake air from and exhaust air to the less clean side of the pass through.

Ducted pass through chambers shall require dedicated, pressure-independent supply and/or exhaust terminals in order to minimize pressurization impact on adjacent classified spaces, and to allow for constant airflow as pass-through filters load.

See [Section 13.6.5 Wall Accessories](#).

---

## 13.8.10 Air Distribution System

Numerous, equally-spaced air outlets, shall be used to create an airflow pattern that generally moves uniformly downwards from ceiling to floor. Air to classified spaces shall be supplied through ceiling mounted terminal HEPA filters. The terminal filters become part of the direct impact boundary. The use of remote HEPA filters in the supply duct shall not be allowed.

All supply terminal grilles shall be of a non-aspirating type, of stainless steel construction. The return/exhaust air outlets in classified spaces shall be located at or near the floor level preferably on at least two walls along the long dimensions of the room to ensure maximum uniformity of airflow. Exhaust outlets in rooms housing LN<sub>2</sub> freezers or controlled rate freezers shall be located within 300 mm (12 in.) of the floor to improve ventilation effectiveness and prevent accumulation of vapors.



On recirculated systems, exhaust outlets (not returns) may be located at the ceiling if the exhaust airflow is small relative to the return air. Equipment and furniture shall not block return/exhaust openings. Return/exhaust outlets shall be avoided under BSCs because this may affect airflow patterns around the BSC. Return/exhaust outlets on ducted systems can be louvered stainless. Where engineered cleanroom return wall systems are used, returns/exhaust may be open-ended near the floor level if the opening is hidden behind the wall. Placement of air walls on only one side of the cleanroom is not recommended.

All supply/exhaust/return ducts shall be directly connected to air outlets. Although permitted in the APF, the use of plenums as a passage for delivery of supply air is not recommended unless the plenum can be tested and meet the requirements for pressure and leakage of the associated duct. Where plenums are used/allowed for supply air, provide HEPA FFU. The use of ceiling plenums for exhaust/return is prohibited.

Each area shall be provided with supply and return dampers to allow proper balancing. Isolation dampers on supply and exhaust shall be used to isolate rooms from other rooms. Bubble tight dampers shall be specified, unless the airflow terminals are selected that can perform dual functions of control and bubble tight isolation.

---

### 13.8.11 Air Handling Capacity

The air handling capacity for systems serving APFs shall follow [Section 6.2.1 Supply and Exhaust Air Handling Capacity](#).

---

### 13.8.12 Ductwork Design

The ductwork design shall meet the requirements of [Section 6.2.2 Ductwork Design](#) except:

1. Flexible supply ductwork should be minimized or avoided due to risk of restricting air from compression and possibility of flexible ductwork unfastening.

2. Supply ductwork shall be galvanized up to the terminal unit and then minimum of 304 stainless steel. All exhaust and return ductwork shall be minimum of 304 stainless steel. The elbow and the first section of connecting duct shall be 316 L stainless steel. This will allow the ductwork to be resistant to harsh cleaning agents or decontamination gases.
3. A total percentage leakage method is recommended in accordance with SMACNA. Ductwork leakage shall be no more than 1%. For hazardous exhaust on the positive pressure side, leakage shall be 0%. 100% of supply/return/exhaust ductwork serving classified areas shall be tested. Leakage from internal components is included in the total leakage test criteria.
4. Provide adequate access to service components such as dampers and reheat coils.
5. Ductwork shall be wiped and cleaned of oil (interior), dirt and metal shavings prior to installation. After ductwork is cleaned, cover the opening with plastic sheeting.
6. Use of self-drilling screws shall be avoided as they generate large amounts of metal chips.
7. All penetrations of ductworks should maintain interior cleanliness.

---

### 13.8.13 Air Intake/Exhaust

The outdoor intake and exhaust discharge shall meet the [Section 6.2.3 Outdoor Air Intakes and Exhaust Air Discharge](#) requirements.

---

### 13.8.14 Air Handling Units (AHU)

The air handling unit (AHU) shall meet the requirements of [Section 6.2.4.2 Air Handling Systems for Laboratory and Animal Research Facilities](#), except aluminum or stainless steel material shall be used in lieu

of galvanized steel. All AHU sections require drainage capability for wash down. All hardware shall be corrosion resistant (304 or 316 L stainless steel is preferred). Multiple smaller direct drive plug fans arranged in an “array” may be used instead of centrifugal fans. Each AHU shall be provided with air flow measurement on supply and return (if applicable). Fans and motors shall be provided with vibration sensors to provide early warning of bearing failure.

The maximum number of rows for cooling coils may be increased to 10 rows to improve performance. The main AHU’s chilled water coil dew point temperature shall be designed at a maximum of 8.9 °C (48°F), to allow the necessary dehumidification needed to maintain room temperature and humidity.

Freeze protection for AHUs (particularly 100% OA) shall be provided and shall meet the requirements of [Section 6.3.8 Freeze Protection Measures for 100% Outside Air Handling Coils](#).

The AHU location should allow sufficient space for servicing its utility connections and internal components. On units that are disassembled after factory testing and reassembled on-site, a pressurized leak test shall be performed to ensure joints/connections are properly aligned and the AHU is not leaking in excess of the specified value.

### 13.8.15 Air Filtration

Air filtration is the primary method to reduce the contaminant levels in an air stream. Air filtration is used at various locations within the HVAC system. Filtration shall meet [Section 6.2.5 Air Filtration Systems](#) requirements, unless indicated otherwise herein.

Pre-level filtration of outside air is typically located within the AHUs. Final filtration (not to be confused with terminal filters), located on or after the final discharge section of the AHU, is used to extend the life of the terminal filters and keep the supply ductwork clean, and shall meet the requirements of [Section 6.2.5 Air Filtration Systems](#). HEPA final filters in the discharge section of the AHU are required on recirculating units serving multiple rooms to prevent cross contamination.

HEPA final filters in the discharge section of the AHU on 100% OA units are typically not required as they serve no additional purpose other than possibly extending the life of the terminal filters.

Filters shall be front loaded so the airflow pushes them into the mounting frame to eliminate bypass. Filter frames shall have closed cell rubber/neoprene type gaskets to prevent shedding. Provide at least 25 mm (1 in.) gap between filter banks in the pre-filter section to permit pressure measurement.

Terminal filters located at the room ceiling shall be HEPA filters (minimum of 99.97%) and shall be generally rated for Class 2 in accordance with UL 900. Terminal HEPA filters shall be designed for maximum of 0.5 m/s (100 fpm). Filter performance shall be specified at the intended face velocity as filter velocity has a significant impact on filter performance (Higher filter velocity, more particles will pass).

Filters shall have silicone gel seal to form a positive seal and eliminate air bypass around the filter edge. Filter housing shall be stainless steel or aluminum welded construction and exposed stainless steel trim with pressure test ports, damper adjustment, and ability to introduce aerosol challenge. The filter shall be capable of being replaced room side.

Fan-filter unit (FFU) is a self-contained filter assembly with fan and speed control and a shallow HEPA filter sealed into a stainless steel or aluminum enclosure.

FFUs used to augment ACH should be avoided in classified spaces especially where they do not use low returns. They may be used in smaller spaces such as gowning or airlocks to provide the extra capacity as long as they have inlets ducted from floor level. Consideration shall be given to service life, replacement of filter, electric wiring and heat generated by fans. Since FFUs are self-powered they may be used where a central air handling system do not have requisite static pressure to overcome pressure drop from the HEPA filter.

FFUs are typically connected in series to the primary AHUs. The FFU fan motors can have premature failures if they are operated when primary air systems are down for long periods of time. However, the use of room bypass duct at each FFU shall be avoided because it creates additional complexity to the overall system.

Poly Alpha Olefin (PAO) shall be used for aerosol challenge for leak testing of HEPA filters. The filter efficiency test in the field shall be based on filter's Most Penetrating Particle Size (MPPS) and not the standard efficiency test that is carried out at the factory (typically using pneumatic Laskin-nozzle type generator at 0.3 micron). Dioctyl Phalate (DOP) is an old aerosol that was used in the past to challenge filters and will not be used due to safety concerns.

HEPA filter gel seal may degrade with time as silicone gel seal material reverts to a liquid state. If this occurs, the gel may begin to drip out the gel track. This may pose a sterility and safety problem. All miter joints in the filter gel channel shall be completely sealed with silicone gel. Gel seals shall not be used since they are affected by cleaning chemicals and aerosol challenge materials such as PAO.

HEPA bleed-through is a phenomenon where a filter fails a filter integrity test (FIT) that had been previously passed at the factory. This occurs mainly with paper-based HEPA filters. Where HEPA bleed-through poses a problem, ULPA or ePTFE filters may be specified. Both ULPA and ePTFE filters are more expensive than HEPA and they may present their own challenges during testing. DTR and DOHS shall be consulted before specifying or replacing the filters with ULPA or ePTFE filters, their use shall be justified.

HEPA filters shall be handled with care and special consideration during shipping and checked for damage during shipment. A thorough inspection is required prior to installation. Filters shall be stored indoors in dry conditions, to prevent damage, or water intrusion, and stored in conditions between 4.4 and 37.8°C (40 and 100°F) and 25% to 75% RH. Filters should be stored in their installed orientation to prevent crushing. Filter housing shall be cleaned using appropriate NIH-approved chemicals and procedures prior to installation of filters.

Carbon filters shall not be allowed in the air handling system serving APF, due to risk of bleed-off.

Temporary filters shall be provided during construction to protect the AHU, ductwork and the space from accumulating dirt. These will be replaced with new filters prior to commissioning and qualification.

## 13.8.16 Exhaust Air Systems

Exhaust air systems shall meet [Section 6.1.22 Exhaust Air Systems](#) requirements. Dedicated exhaust systems shall be provided for APFs and shall not tie into the building exhaust system.

Ducted BSCs handling hazardous or potent exhaust shall be independent of the general exhaust to allow proper control of BSC exhaust.

Exhaust fans shall comply with [Section 6.2.7 Fans](#) requirements. The exhaust fans shall operate as constant volume; however, each fan shall have all the necessary components to be capable of variable volume operation. Fans and motors shall be provided with vibration sensors to provide early warning of bearing failure.

Exhaust filtration is not typically required on any exhaust (including hazardous exhaust tied to ducted BSCs, since hazardous air is HEPA filtered at the BSC before it is discharged outdoors).

Exhaust air discharge velocity and stack height shall follow laboratories and animal facilities requirements as described in [Section 6.2.3 Outdoor Air Intakes and Exhaust Air Discharge](#). Each exhaust fan stack shall be equipped with a Variable Geometry Nozzle (VGE) to allow the exhaust fans to modulate airflow and still maintain a discharge velocity of 15.24 m/s (3,000 fpm). As an alternative, an outdoor air intake hood and bypass damper shall be installed or "strobic" style high induction exhaust fans may be employed.

Air dispersion modelling shall be provided as described in [Section 6.2.3 Outdoor Air Intakes and Exhaust Air Discharge](#) for re-entrainment of the general and infectious exhaust discharge air with the intake air to confirm the location of the exhaust discharge.

---

## 13.8.17 Humidification System

Steam injection type humidifiers providing dry steam (without downstream condensate droplets) is required for APFs because it is bacteria free. Plant steam and RO water for make-up (and potable water for backup) shall be used to provide chemical-free steam via steam-to-steam redundant (provide option for pressurized or atmospheric). This chemical free low-pressure steam

should be piped to a short absorption distance dispersion manifold assembly which will be installed inside AHUs, upstream of the cooling coils, which will allow the cooling coil to double as a moisture eliminator, mitigating nuisance smoke detection alarms and reducing the risk of water damage to the fans and APF spaces. Humidifiers shall have automatic isolation valves to remain closed during cooling mode.

Humidifiers located within ductwork, or downstream of the supply fan shall be avoided because of risk of flooding of ductwork.

---

### 13.8.18 Chilled Water Systems

Chilled water to APF AHUs shall be provided from central utility plant (CUP) and shall meet [Section 6.3.6 Chilled Water Systems](#) requirements. To help mitigate discharge air temperature and dew point fluctuations of AHUs due to varying chilled water temperatures from the CUP, supplemental air-cooled chiller shall be provided. n+1 redundancy of this supplemental chiller is not required; however, pumps shall be redundant. Typically, designs provide an indoor insulated storage tank between the supplemental chiller and AHU trim coil to allow the supplemental chilled water system to respond quickly to sudden changes in CUP supply chilled water temperature. The supplemental chiller design shall be based on CUP supply temperature rising 2°F (from 45°F to 47°F). The chiller shall be piped to separate AHU trim coil. AHU trim coils shall also be piped to the plant chilled water loop, but would remain isolated closed during normal operation when the supplemental chiller is operational.

For small APFs such as modular trailers where CUP chilled water is not available in close proximity, n+1 redundant air-cooled chillers shall be provided.

---

### 13.8.19 Heating Water Systems

Heating water systems shall meet [Section 6.3.5 Heating Water Systems](#) requirements. Preheat system shall be

glycol preheat water. Provide glycol concentration per DRM requirements for freeze protection. See [Section 6.1.24 Systems Failure and Disaster Mitigation](#). Direct steam heating systems should be avoided, unless reviewed and approved by DTR.

---

### 13.8.20 Steam System

Steam systems shall meet [Section 6.3.7 Steam Systems](#) requirements. Where monographed pure steam is required for direct impact process applications, steam shall be produced from RO water (typically single pass) that has been produced directly from potable water as described for Pharmaceutical Water WFI production in [Section 13.10.3 Pharmaceutical Water](#). Membrane contactors should be considered for degasification.

---

### 13.8.21 Piping

Piping shall meet [Section 6.3.9 Piping](#) and [Exhibit 6.3 Piping Designation, Material, Fittings, and Joints](#) requirements. Use stainless steel piping for pure clean steam with sanitary weld joints post-fabrication passivation. Valves and components for all clean/ high purity systems shall be sanitary type with no lubricants or other contaminants that may contaminate the process fluid. All components, instrumentation types and connection arrangement serving high purity system application shall be free of dead legs, and contamination-prone fouling area in contact with the system fluid.

Fluid piping over APF spaces shall be limited to that required specifically to serve such spaces. Utilities serving other areas of the facility shall not be located above ceilings or within walls serving APF spaces unless unavoidable, justified, and subject to approval. Fluid piping over APF spaces shall be limited to that required specifically to serve such spaces. Utilities serving other areas of the facility shall not be located above ceilings or within walls serving APF spaces unless unavoidable, justified, and subject to approval. In some cases, DTR may require fluid services to be double-contained and provided with automatic leak detection.

### 13.8.22 Service Access Panels, Mechanical Spaces and Maintenance Consideration

Access panels in the classified boundary areas shall be avoided, since they could become a source of contamination or air leakage. To the extent possible, piping, valves, dampers, and air terminals shall be located outside the classified boundary. Major equipment, valves, dampers, and terminal units serving classified spaces shall be located in interstitial or mechanical penthouse or mechanical spaces to allow for maintenance staff to have easy access to equipment and devices. Access to field calibration, testing and repair should be considered. Access for removal of large motors and equipment shall be considered. Where piping must be exposed within APF spaces, it shall be mounted to walls or ceilings with manufactured, non-corrosive 316 stainless steel sanitary (hygienic) piping supports of the rounded ASME BPE compliant type, with silicone, PTFE, or approved equivalent inserts. Supports shall be free of entrapment areas, smooth and polished, and arranged to ensure piping stands-off from finished walls or ceilings at least 25 mm (1 in.).

Where insulated piping is required within APF areas, the insulation and joint system shall be specifically manufactured to be particle-free (including during cutting or impact), suitable for routine wash-down, sanitary, chemical-resistant, fully sealed, and readily cleanable for use in clean room applications. Alternatively, insulated piping may be fully encased in an approved durable and sanitary containment annulus of not less than Schedule 5 wall thickness, with approved sanitary termination fittings. Insulation shall be halogen free, closed-cell, non-fibrous, and dust-free. Examples of suitable products may include closed-cell white PVDF foams, however melamine insulation and insulation with PVC jacketing is not acceptable.

### 13.8.23 Emergency Electrical Power

Supply air fans, exhaust fans, controls and BAS and all devices and equipment serving APFs shall be connected to an emergency power system. Emergency loads shall be able to transfer standby power in 10 seconds, but not more than 20 seconds.

Following a power outage, and initiation of emergency electrical power, all VFDs associated with supply and exhaust fans shall restart into a coasting motor (catching motor on the fly) without delays and without damaging the motor.

---

### 13.8.24 Equipment, Ductwork, and Piping Identification

Equipment, ductwork and piping systems shall be accurately identified. Services specific to APF shall clearly designate function and direction to avoid cross connections, service disruptions and aid in maintenance and operations.

# Section 13.9

## APF Design Requirements: HVAC Controls

---

### Contents

- |  |  |
|--|--|
| <b>13.9.0 Introduction</b>                               | <b>13.9.9 Cross-Limiting Loop</b>                            |
| <b>13.9.1 General Requirements</b>                       | <b>13.9.10 Airflow Tracking</b>                              |
| <b>13.9.2 Terminal Units</b>                             | <b>13.9.11 UPS and Emergency Power</b>                       |
| <b>13.9.3 Isolation Dampers</b>                          | <b>13.9.12 Terminal Damper Actuators</b>                     |
| <b>13.9.4 Differential Pressure Monitors</b>             | <b>13.9.13 Interface on Variable Frequency Drives (VFDs)</b> |
| <b>13.9.5 Critical Parameter Control and Sensors</b>     | <b>13.9.14 Fan Failure</b>                                   |
| <b>13.9.6 Room Pressurization Control</b>                | <b>13.9.15 HVAC Controls Resilience and Recovery</b>         |
| <b>13.9.7 Controllers and Supply / Exhaust Interlock</b> | <b>13.9.16 Additional BAS Quality Requirements</b>           |
| <b>13.9.8 Loss of Pressurization</b>                     |  |



## 13.9.0 Introduction

This section describes the general building automation systems (BAS) design considerations, as well as the specific requirements for control sequence design and construction document submittals. APFs shall meet all the requirements of Sections 7.1-7.6 and meet additional requirements as outlined in this section. These additional requirements provide a greater level of safety and reliability of operation. Refer to [Section 13.8 APF Design Requirements: HVAC](#) for additional mechanical requirements and controls related to this chapter.

### 13.9.1 General Requirements

HVAC and building system parameters shall be monitored and controlled on an appropriately commissioned and tuned BAS control system. Critical HVAC control parameters (including: space temperature, humidity and room differential pressure) shall be monitored, recorded, and alarmed on a validated Environmental Monitoring System (EMS). Refer to [Section 13.14 APF Design Requirements: Environmental Monitoring System \(EMS\)](#) for details on EMS.

All field devices for critical BAS and EMS shall be co-located and have similar accuracy, repeatability, stability and tolerances to the extent possible. These field devices shall also be maintained under a quality change control and calibration system because they are mimicking the validated EMS.

Based on the System Level Impact Assessment (SLIA), NIH may elect to manage other HVAC or other systems or components or control devices under the quality change control and calibration system. As an example, terminal units controlling the critical parameters in classified rooms could be determined as direct impact and be maintained under the quality change control system.

### 13.9.2 Terminal Units

Supply and exhaust systems shall be controlled by one single controller with stand-alone capability. All programming shall be provided via a single programming

language. All units serving APF areas shall be controlled by a primary controller, preferably the same controller which manages the supply (this shall be limited by size). Refer to [Section 6.6.2 Supply Air Systems](#) and [Section 6.6.7 Exhaust Air Systems](#) for requirements for supply and exhaust terminals. All controllers in APF spaces shall provide stand-alone capability at the suite level. The A/E shall clearly indicate both tracking relationships between airflow terminals and clearly indicate the classified boundaries of a collection of rooms (suite) that shall be controlled by the same controller.

### 13.9.3 Isolation Dampers

Automatic dampers in the exhaust shall fail-open. Automatic dampers in the supply shall fail-closed if another means is not provided to prohibit reverse pressurization in the time specified below in the event of applicable failures. If the supply automatic damper is not providing this reverse pressure protection, it shall fail-open. The position of automated isolation dampers shall be monitored (make contact on close). Refer to [Section 6.6.9 Isolation Dampers](#) on specification requirements for the isolation dampers.

Isolation damper closing rates shall be tuned to isolate the lagging system more quickly than the leading system, to ensure airflow in the correct direction.

### 13.9.4 Differential Pressure Monitors

The BAS shall provide differential pressure monitors on classified spaces to indicate the room differential pressure and shall alarm when the pressure goes beyond adjustable thresholds and time durations established in concert with DFOM, DTR/FCIS, ORSC and IC.

Classified space may be equipped with a sensor indicating the status of the door (open or closed). This sensor shall provide an input to the room differential pressure monitor in order to disable or provide a delay on the alarm parameter as appropriate to the door's position.

Differential pressure monitors for all rooms should be mounted outside the entrance door to the room being

monitored (in unidirectional personnel flow); provide an additional red/green indicator lamp on the opposite side of the door (in bidirectional personnel flow); or placed in a central panel, so long as the panel location is in line of sight of the rooms being monitored.

### 13.9.5 Critical Parameter Control and Sensors

Critical HVAC parameters are particular to individual products and processes. Main factors to consider for a monitoring system include:

**A. Accuracy and Repeatability:** Control set points should be selected to assure that errors (drift, hysteresis, accuracy) do not combine to allow a condition outside acceptable operating range. This is very important in systems where multiple instrument signals are used to calculate a control response. All sensors shall be NIST traceable or to a industry standard.

Common monitored environmental parameters include:

1. Airflow
2. Differential pressure (dP) between spaces
  - a. dP will be electronic pressure transducers with indicator readouts to allow operators to see the measured value. Accuracy will be  $\pm 1.25$  Pa ( $\pm 0.005$  in. w.g.).
3. Temperature
  - a. All temperature sensing for the HVAC systems will be accomplished using either electronic 100-ohm platinum RTD sensors with 4-20 mA transmitters or 1,000-ohm platinum RDT elements without transmitters (cGMP areas) or thermistors (non-cGMP areas). Sensor accuracy will be  $0.06^{\circ}\text{C}$  ( $0.1^{\circ}\text{F}$ ). Sensor shall be compatible with hydrogen peroxide, peracetic acid and sodium hypochlorite.
4. Relative Humidity (RH)
  - a. Room humidity sensors (for monitoring only) will be industrial, capacitance type and compatible with hydrogen peroxide,

peracetic acid and sodium hypochlorite. Sensor accuracy will be  $\pm 2\%$  RH.

**B. Long-term Stability and Failure Modes:** Some instruments are prone to drift out of calibration sooner than the others. Maintenance and recalibration frequency should be based on manufacturer's recommendations. Failure modes should be considered by designers. A failure mode should be chosen that is safer for the product and personnel and maximizes the probability of detection.

**C. Sensor Location:** All field devices for critical BAS/EMS should be co-located, mounted for easy access, calibration and replacement. Potential lack of uniformity throughout a space should be considered for mounting space temperature and humidity sensors. For example, temperature sensors shall not be placed next to BSCs or heat producing equipment where they may impact temperature control and uniformity.

Co-location of temperature sensors shall be interpreted to mean installed at the same elevation, on the same wall plane, within 914 mm (3 ft.) of each other. Co-location of RH sensors shall be interpreted to mean installed on the same plane, within 914 m (3 ft.) of each other. Co-location of dP sensors is not as critical, but the displays should be installed at the same elevation, on the same wall plane, within 914 m (3 ft.) of each other.

Location of heat and humidity producing equipment shall be considered in the placement of room sensors. Where practicable, sensors shall be located outside the controlled space, but accessibility for maintenance must be considered. Temperature and humidity sensors located in return or exhaust ducts can also provide a reasonable reference for the room conditions as long as they are located close to the room and can be accessible for maintenance and calibration.

**D. Alarm Requirements:** It is considered good practices to set the action alarm at the extreme acceptance conditions and have an engineering "alert" at conditions just outside the normal operating range to alert engineering personnel of a potential unusual condition. Differential pressure (dP) can change very quickly, and therefore, has potential to create nuisance alarm whenever a door is opened. DP alarms should have time delays. The duration of the time delay should be sufficient (not less than 120 seconds) to permit the normal passage through an open door and for the system to recover.

**E. Sensors Resistant to Damage:** All sensors in contact with cleaning chemical shall be compatible with hydrogen peroxide, peracetic acid, and sodium hypochlorite. A stainless steel hat, sensor configuration, and/or sensor design should be resistant to wetting during cleaning, and consequent damage.

**F. Record Requirements:** The frequency of data collection is dependent on the parameter being measured.

1. Differential pressure data should be collected at 1 minute intervals due to rapid changes in value, such as door openings.
2. Temperature and RH data may be collected at intervals up to 15 minute intervals because these values tend to change slowly.
3. The sensor data archiving requirement shall be designated by latest facility BOD and SOP.

**G. Ease of Maintenance and Calibration:** The selection of sensors and other field devices should be considered in order to select the most effective type of sensor and method of calibration.

---

## 13.9.6 Room Pressurization Control

To control the migration of contaminants, the air distribution systems shall be designed to attain pressure level within each room relative to all adjacent areas. In general, the design shall provide airflow cascading from clean to less clean areas.

APFs require multiple levels of room pressurization. Pressures shall be maintained to ensure proper directional airflow between zones. Passive cascading flow tracking (fixed offset) pressurization control system is the most commonly used method in APFs. Active pressurization control may be considered by the A/E based on cascade flow tracking control with pressure based reset of offset. See [Section 13.8.8 Pressurization](#).

Direct pressure measurement based active pressurization control is not allowed in APFs.

To the extent possible space pressurization for each classified room shall be controlled by a single pair of

supply and exhaust terminals. No space shall be pressure controlled using only a single terminal unit (supply or exhaust), or have a single unit serve multiple rooms.

To the extent possible, pressure differentials between rooms shall be achieved using gaps around doors and door undercut. The use of pressure stabilizers or relief vents for maintaining pressure differentials between rooms shall be avoided due to a number of concerns, including a heightened risk of contamination during an air reversal condition, difficulty to clean and maintain, etc. Such devices may be considered in special cases and shall be reviewed and approved by NIH on a case by case basis.

See [Section 13.9.4 Differential Pressure Monitors](#).

---

## 13.9.7 Controllers and Supply/Exhaust Interlock

Controllers monitoring and adjusting the HVAC in APF areas shall be primary controllers.

Terminal controls shall be panel-based (instead of having controllers for each unit). Controllers on terminal units requiring frequent calibration (such as every 12 hours) are NOT allowed, even when they are provided with Auto Zero Modules (AZM). This is because frequent calibration using AZM could upset pressure differential dynamics in the space.

Provide an interlock (between the supply controller and the exhaust controller) indicating exhaust system status and supply system status, such that the lagging system can confirm operation of the leading system in the absence of the controller local area network (LAN) communication. Where multiple controllers are controlling the supply and exhaust systems, status outputs shall be wired in parallel.

The interlock between the exhaust and supply shall be designed to keep positive or negative pressure to the adjacent rooms at all times per the program requirements. Components shall be selected so that in any realistic failure scenario, the supply airflow rate will decrease more quickly than the exhaust for negative spaces or vice versa for positive spaces. This requires that the A/E consider the control sequence and actual/

required responses of all drives, sensors, fans, dampers, and damper actuators. Based on this, the A/E shall confirm that all practical measures have been implemented to ensure maintenance of required pressure at all times.

---

### 13.9.8 Loss of Pressurization

The A/E shall analyze the potential for loss of space pressure control due to power loss, generator testing, or controller failure and design the controller configuration to minimize risk. Fail positions (fail in last position) of the air valves shall be such that classified space pressurization is maintained to the extent possible. Upon main system failures (such as loss of AHU or exhaust fan), the valves shall fail-closed to ensure pressurization is not reversed.

---

### 13.9.9 Cross-Limiting Loop

In APF spaces, as the spaces are constructed to have minimal leakage, a cross-limiting loop shall be provided (the control sequence shall automatically reset the flow-rate set point in the lead terminal box upon detection of excessive flow differential) to restrict the leading system from exceeding the lagging system by a specified value that shall be set to prohibit excessive door-opening forces. Values shall be set such that the control loops do not interact under normal operation. Cross-limiting does not apply to chemical fume hoods, biological safety cabinets (BSCs), canopy hoods, or other safety equipment. As an example, if the normal offset is to have the exhaust volume 75 L/s (160 cfm) lower than the supply, another control loop shall restrict the exhaust to no less than 150 L/s (320 cfm) below the supply, otherwise it could be difficult to open the space door.

---

### 13.9.10 Airflow Tracking

Airflow tracking control shall maintain differential pressures between adjacent spaces. There shall never be a condition in which the control system goes outside this range for more than 2 minutes (adjustable) and designed directional airflow must be sustained. The APF spaces

shall be designed such that under failure conditions the airflow will not be reversed. This has significant implications for the central systems serving the APF concerning starting, power outage, rotation, and proof logic and hardware. The monitoring requirements include:

1. Space temperature
2. Space differential pressure with local indication (where required)
3. Alarm conditions and strobe in associated rooms, outside of all entry doors
4. Humidity (where zone-level humidity is required only)
5. Supply/exhaust velocity (total/static differential) pressure.
6. HEPA-filter pressure (refer to component) (when provided)

---

### 13.9.11 UPS and Emergency Power

Central system controllers shall also be on an uninterruptible power supply (UPS) and emergency power, and must detect power interruptions and take appropriate action locally. This in effect means providing a three-phase monitor as an input to the controller.

Zone terminal-unit controllers shall be on emergency power so they can continue to control through power interruptions.

---

### 13.9.12 Terminal Damper Actuators

Terminal damper actuators shall be “fast-acting”. Damper fail positions shall be selected to fail in last position or fail-closed (for both exhaust and supply) depending on the type of failure. If the failure is at the local actuator level then fail in last-position actuators may be used, otherwise fail-closed shall be utilized.

### 13.9.13 Interface on Variable Frequency Drives (VFDs)

The interface between the BAS controller and VFD shall be hard-wired directly, point-by-point from the BAS to the VFD interface board. Interface shall not be done through digital communications except as provided supplementary to the hard-wired interface. See Table 13.9.13.

---

### 13.9.14 Fan Failure

The supply system status indication to be used in failure and restart logic shall consistently indicate a change in status within 10 seconds. Status indications shall further be capable of distinguishing belt breaks from normal operation at minimal load. Either current switches or differential pressure switches will be used. The current switches minimum operating amperage draw shall exceed that of the no-load motor at 60 Hz. Upon a supply fan failure, either a redundant supply fan shall start, or if the redundant fan is running, then it shall ramp up. If ramp up is not achieved or there is no redundant fan, both the supply and exhaust fan(s) shall shutdown. Similar sequence shall be used for exhaust fan failure.

Pressure cutout switches shall be tuned to trip the unit when extended beyond normal pressure, but shall have an adequate delay to avoid nuisance trips due to short transient excursions. Trips from excessive pressure shall be manually reset.

Under failure conditions, the airflow will not be reversed.

### 13.9.15 HVAC Controls Resilience and Recovery

Controllers shall have the capability to automatically restore their volatile memory upon loss of power.

---

### 13.9.16 Additional BAS Quality Requirements

Controls contractor shall submit all programming code for review and approval by DTR and DFOM. Code shall be clean and devoid of unused or “Junk” code which will be verified via commissioning of the BAS system.

**Table 13.9.13 Minimum Instrumentation Requirements**

Instrumentation Certification Type								
Air	Hydronic	Function	Minimum Range		Accuracy	Resolution		Calibration Interval
•	•	Rotational Measurement	0 to 5,000 RPM		± 2% of reading	± 5 RPM		12 Months
•		Air Temperature Immersion Temperature	-40 to 115C	-40 to 239 F	± 1% of reading	± 0.1 C	± 2.18 F	12 Months
	•	Contact Temperature						
•	•	Volts AC	0 to 600 VAC		± 2% of reading	1 V		12 Months
•	•	Amperes	0 to 100 Amps		± 2% of reading	0.1 Ampere		12 Months
•		Air Pressure	0 to 2,500 Pascals	0 to 10 in. w.g.	± 2% of reading	2.5 to 250 Pa	0.1 to 1.0 in. w.g.	12 Months
•		Air Velocity (not for Pitot traverses)	0.25 to 12.5 m/s	50 to 2,500 fpm	± 5% of reading	0.1 m/s	20 fpm	12 Months
•		Relative Humidity	10 to 90% RH		± 2% RH	1%		12 Months
•		Direct-Reading Hood	50 to 1,000 L/s	100 to 2,000 cfm	± 5% of reading ± 2.5% L/s (5 cfm)	Digital: 0.5 L/s (1 cfm) Analog: N/A		12 Months
•		Pitot Tubes (2 of adequate length for intended use)	45 cm min.	18 in. min.	N/A	N/A		N/A
	•	Hydronic Pressure Measurement (Pressure Gauges)	-760 mm hg to 400 kPa 0 to 700 kPa 0 to 1400 kPa	-30 hg to 60 PSI 0 to 100 PSI 0 to 200 PSI	± 2% of reading	± 3.3 kPa ± 6.7 kPa ± 16.7 kPa	± 0.5 PSI ± 1.0 PSI ± 2.5 PSI	12 Months
	•	Hydronic Pressure Measurement	0 to 25 kPa 0 to 300 kPa	0 to 100 in. w.g. 0 to 100 ft. w.g.	± 2% of reading	250 Pa 3.0 kPa	1.0 in. w.g. 1.0 ft. w.g.	12 Months

Table based on NEEB TAB Procedural Standards, Table 4-1 NEEB Minimum Instrumentation Requirements.

Instrumentation with multiple capabilities shall be accepted for more than one function when documented as each separate function meets these requirements. Calibrations of all instrumentation requiring calibration shall be traceable to current NIST Standards for US-based facilities or equivalent organizations in other countries.

The minimum calibration intervals listed on this table do not necessarily reflect the risks associated with APFs. Often particularly with Temperature, Relative Humidity, and Differential Pressure sensors, the interval set in the URS according to risk analysis to shorter periods. The EMS and BAS sensors should be recalibrated contemporaneously, and to the extent practicable using the same NIST calibrated devices.



# Section 13.10

## APF Design Requirements: Plumbing

---

### Contents

13.10.0 Introduction

13.10.1 General Requirements

13.10.2 Domestic Cold and Hot Water Systems

13.10.3 Pharmaceutical Water

13.10.4 Drain and Vent System

13.10.5 Sinks and Faucets

13.10.6 Emergency Fixtures

13.10.7 Liquid Nitrogen (LN<sub>2</sub>)

13.10.8 Clean Compressed Gases

13.10.9 Pharmaceutical Compressed Air

13.10.10 Vacuum

## 13.10.0 Introduction

This section addresses additional specific requirements for all plumbing and process piping systems in APFs. Refer to [Chapter 8: Plumbing Design](#) and [Chapter 12: Special Process Piping Systems](#) for baseline requirements.

---

### 13.10.1 General Requirements

Systems that are considered direct impact in APFs will receive full testing, commissioning and validation throughout the construction process including but not limited to materials, equipment and methods verification, and any items that may affect fluid quality, reliability, initial purity, or potential for contamination.

Isolation valves for pressurized piping penetrations as well as components requiring routine service shall be located outside the classified spaces. To the extent possible, pressurized water and waste piping in ceilings over classified spaces shall be avoided to limit damage to spaces from leaks.

Fluid piping over APF spaces shall be limited to that required specifically to serve such spaces. Utilities serving other areas of the facility shall not be located above ceilings or within walls serving APF spaces unless unavoidable, justified, and subject to approval. In some cases, DTR may require fluid services to be double-contained and provided with automatic leak detection. Pipe penetrations through clean room walls and ceiling shall be constructed of 316 stainless steel (SS) mounting rings and flexible white silicone boots.

Where piping must be exposed within APF spaces, it shall be mounted to walls or ceilings with manufactured, non-corrosive 316 stainless steel sanitary (hygienic) piping supports of the rounded ASME BPE compliant type, with silicone, PTFE, or approved equivalent inserts. Supports shall be free of entrapment areas, smooth and polished, and arranged to ensure piping stands-off from finished walls or ceilings at least 25 mm (1 in.).

Where insulated piping is required within APF areas, the insulation and joint system shall be specifically manufactured to be particle-free (including during cutting or impact), suitable for routine wash-down, sanitary, chemical-resistant, fully sealed, and readily cleanable

for use in clean room applications. Alternatively, insulated piping may be fully encased in an approved durable and sanitary containment annulus of not less than Schedule 5 wall thickness, with approved sanitary termination fittings. Insulation shall be halogen free, closed-cell, non-fibrous, and dust-free. Examples of suitable products may include closed-cell white PVDF foams, however melamine insulation and insulation with PVC jacketing is not acceptable.

Lab water may not be used as a source of water supply for any APF since lab water may be subject to a variety of hazards that may compromise the quality of water introduced in APFs.

---

### 13.10.2 Domestic Cold and Hot Water Systems

APFs are sensitive to microbial and chemical contamination which may be present in incoming domestic water. While incoming municipal water includes chlorine residual from source water disinfection to reduce microbial contamination, there is no guarantee that it will be free of microbial contamination at the point of use. For this reason, domestic water should only be present at the early stages of gowning and late stages of de-gowning for hand washing and as a water source for non-sterile equipment processes (e.g. autoclave vacuum pumps and wash equipment). Sink traps can become a source of mold or pathogens and may require a significant cleaning and disinfection control regimen to control contamination. Generally, domestic water should be avoided in ISO 8 areas. Domestic water is inappropriate for use in ISO 7 or ISO 5 areas, except where required for scientific use and where additional approved treatment is provided.

Where domestic cold and hot water is required in the classified areas, the A/E shall review the building domestic hot and cold water system, prior to designing the system for APFs, at a minimum:

1. Cold water systems shall maintain and deliver to the use point potable water at a temperature not to exceed 18.3°C (65°F). Hot water systems shall maintain and deliver potable hot water to the use point at a temperature of not less than 51.7°C (125°F). Where possible,

- hot water should be delivered to the use point between 56.7°C and 60°C (134°F to 140°F) with final temperature control integral with the faucet or immediately at the point of use without dead legs.
2. The quantity and length of dead legs in hot and cold water piping shall be minimized. Distribution systems shall be arranged to ensure daily fresh water turnover via normal passive operation and without sections of stagnation. To the extent possible avoid reliance on the use of any single fixture to achieve daily water turn-over.
  3. Recirculation shall be provided for hot water systems. The maximum permissible length of uncirculated piping shall be limited to that which produces a 15 second wait time to achieve full hot water distribution system design temperature at the use point. In no case shall the length of any hot water system uncirculated piping section exceed 6.1 m (20 ft.) developed pipe length.
  4. Where feasible, the use of faucets with integral thermostatic/ mixing controls and 60°C (140°F) hot water supply direct to the faucet should be utilized. Sensor faucets that incorporate a thermal disinfection mode are favored provided the discharge outlet is located immediately at or adjacent to the mixing valve and with minimal or no tempered water outlet dead leg. The use of wall mount mixing arrangements that drain completely with each use (e.g. wall mount digital mixer faucets) should be considered. Laminar flow outlets shall be utilized instead of aerators. Serrated tip outlets and submersible hose attachments shall be avoided.
  5. The mixing valve at the sink shall be located immediately at the exposed faucet supply where integral mixing faucets are not used. The intent is to absolutely limit the dead leg distance downstream from the mixing valve outlet where water can stagnate. Self-draining arrangements (e.g. wall mount digital mixers and spouts) are preferred, but not mandatory.
  6. The use of disinfectant injection (catalytic-generated or procured ANSI/ NSF-60 chlorine dioxide) or water filtration should be evaluated on a case by case basis and, be based on a full risk assessment and, life cycle costing and, shall be reviewed and approved by DTR. Due to risk of damaging the stability of pipeline corrosion inhibiting films, (even where disinfectant residuals are elevated within Safe Drinking Water Act levels) as well as potential efficacy, by-products and potability concerns, the injection of additional chlorine is unacceptable.
  7. The use of water filtration is not recommend for microbial control due to the required frequency of filter replacement, as well as pressure and flow issues associated with suitable filters. If filters are not rigorously maintained, microbial conditions could get worse both upstream and downstream. Though certain Point of Use (POU) filters may be beneficial in some applications, POU water filters should not serve as a primary microbial control device, and their selection and application requires justification and pre-approval. The maintenance of appropriate hot and cold water temperatures, avoidance of stagnation, and (if necessary) supplemental water treatment (catalytic generated or ANSI/ NSF-60 procured chlorine dioxide) is preferable to other means of domestic water system microbial control, however the use of any water treatment process requires water supply analysis, confirmed continued potability validation, and DTR pre-approval, including implementation of procedures to maintain operation and monitor water quality.
  8. Zone-level filtration shall not be utilized for microbial control due to long-term efficacy concerns, potential routine-maintenance, and induced contamination associated with routinely depressurizing, opening, and re-pressurizing components, and potential for upstream or downstream contamination associated with inadequate maintenance. High purity water is not a recommended alternative for this application due to significant infrastructure cost necessary to ensure reliable microbial-controlled water.
  9. Water supply branch piping to APF spaces shall include “Aseptic Facility” or similar

application-specific text in their pipe line identification nomenclature. This is to avoid unrelated tapping or disruption of pressurized services, which could induce contamination.

10. Solvent cemented joints, natural rubber, hydrocarbon cutting oils, and other sources of contamination that may substantially elevate TOC shall be avoided in the water supply serving APFs. Refer to [Section 8.3 Water Systems](#) for further requirements to maintain system microbial control, including requirements for water heaters/ source equipment.

### 13.10.3 Pharmaceutical Water

The term “Pharmaceutical Water” is intended as a generic descriptive term to be inclusive of purified waters of various qualities. The specific water application shall be identified by nomenclature as utilized in the USP monograph (e.g., USP Purified Water, Water for Injection, etc.). Pharmaceutical waters in APFs have multiple uses including:

1. Ingredient in preparation of parenteral compounding
2. Sterile diluent for parenteral products
3. Solvent in preparation of intermediates
4. Preparation of cleaning solutions/rinsing
5. Analytical laboratory as analytical reagents

Pharmaceutical water can be either produced at site (bulk) or procured as packaged. Due to complexity and cost of design, maintenance and validation, on-site pharmaceutical water systems should be avoided in APFs where possible. Where demand, storage space, cost and logistics of procuring and handling packaged water is too prohibitive, pharmaceutical water(s) may be produced at site for both monograph and non-monographed water applications. Any pharmaceutical water intended to be packaged must additionally meet the STERILE monographed water requirements as non-sterile waters and waters that do not contain adequate contaminant restriction may result in quality degradation.

Water that is used as a dosage form ingredient or

parenteral must be compendial (monographed) water. Any pharmaceutical water whose variability may have an impact on a critical quality attribute (CQA) shall be provided as fully controlled, independent, dedicated and validated compendial water. Compendial water is typically (but not exclusively) associated with parenteral compounding or a sterile diluent for parenteral products (including cleaning of certain parenteral contact components) and shall comply with USP requirements for Water for Injection (WFI). WFI is injected directly into patients bypassing the body’s primary defensive systems. WFI water is subjected to regular testing according to the USP monograph.

Pharmaceutical water systems shall comply with the most current USP compendium as a primary requirement as well as any more restrictive and supplemental requirements as addressed in [Chapter 12: Special Process Piping Systems](#) and [Appendix N: High Purity and Animal Drinking Water System Sanitization, Lab Testing, and Acceptance](#). Site produced (Bulk) pharmaceutical water shall be sourced directly from potable water supply and shall be completely independent of laboratory or other process purified water systems. Pharmaceutical water systems shall be located in secure areas which facilitate reliable operation and service activities to occur without contamination. Deionization methods utilized in pharmaceutical water shall be electrodeionization (EDI) type.

Bulk WFI water shall have total microbial count of less than 10CFU/100ml, conductivity of less than 1.3 mS/cm referenced to 25°C (77°F), less than 10 ppb TOC and less than 0.25 EU/ml Endotoxin. Low design TOC levels are essential to maintaining system microbial control and shall be complied regardless of means of disinfection.

Subject to evaluation of all fluctuations of source water conditions and design to confirm reliable compliance with water quality specifications, the Bulk WFI water system shall include at least:

1. **Pretreatment:** Ion-exchange type softening, redundant carbon sorption, and a sanitary RO system (at least single-pass) with appropriate bio-fouling control.
2. **Primary Treatment:** Either multi-effect still or the second pass from a two-pass hot water sanitizable, FDA sanitary (full-fit type) RO system.

- Final Treatment:** Distillation based systems shall be circulated and maintained as high temperature systems (80°C [176°F]) and incorporate point of use sanitary heat exchangers. Final filtration is not required for distillation based systems, but may be utilized to limit build-up of cell fragments and non-replicating particles. Membrane based systems (two pass RO without distillation) shall incorporate ultrafiltration or final microfiltration compliant with [Chapter 12](#). The final filtration system and storage tank shall be either hot water or ozone sanitizable and so-configured. Where membrane-based systems are not maintained and distributed at high temperature, the final filtration (including the final permeate storage tank) shall incorporate electrolytic generated ozone-based sanitization and ozone destruct in conformance with [Chapter 12](#). Where ozone is used, it shall be continuously present in the storage tank and utilized at least weekly for the distribution loop.

Where necessary to reliably achieve required conductivity, electrodeionization (EDI) may be used in the treatment process but only if positioned upstream of the primary treatment (second pass RO) process. Oxidizing UV (185nm) may be used only for minor TOC polishing applications (after primary TOC removal). The restriction of UV to minor polishing applications is to ensure continued efficacy and to prevent generation of hazardous byproducts. Oxidizing UV and other polishing equipment shall not be used in place of either (a) RO followed by distillation or (b) two-pass RO configurations. Where dissolved gas (e.g. CO<sub>2</sub>, oxygen, or ammonia) removal is required, such may be accomplished through use of ultra-pure water membrane contactors or EDI prior to 2nd pass RO (or for CO<sub>2</sub> removal by technical-grade pH adjustment prior to 2nd pass RO). Where both membrane contactors and EDI is utilized, the membrane contactor shall be located prior to the EDI. EDI may be utilized only for CO<sub>2</sub> reduction only where determined sufficient (typically applications with less than 10 mg/L concentration). EDI shall not be used without prior RO treatment.

Tanks for WFI shall be 316 L stainless steel, electropolished and maximum 15 Ra, and shall include a clean sterile filtered monographed either argon (preferred) or nitrogen blanket, except that heat-sterilized, heat traced

sterile gas vent filtration may be utilized for some applications. Sanitary rupture disk tank arrangements are required. Where monographed argon is available it is preferred for inherent purity and avoidance of nitrogen-fixing bacteria.

WFI water shall be continuously recirculated in a 15 Ra and electropolished 316 L stainless steel pickled and passivated distribution system with autogenous orbital welds, except that for low temperature, non-heat sanitized systems infrared fusion nature PVDF piping may be utilized. Where heat exchangers are utilized, the system shall be designed such that the WFI or USP water is always at a higher pressure than the process fluid, and double wall, ultrapure type is required. All components shall be arranged to maintain system sanitation and suitable for clean-in-place/sterilization in place (CIP/SIP). Strict controls shall be established for system-design quality control, all wetted materials, elastomers, installation, inspection, and handling processes, and for all component and equipment selections that will be in contact or could impact product water quality or reliability. Dedicated serpentine distribution is required for WFI.

Bulk USP Purified Water shall have total microbial count of less than 100 CFU/100 ml, conductivity of less than 1.3 mS/cm referenced to 25°C (77°F), and less than 20 ppb TOC. Preferred method of production is filtration, ion-exchange type softening, carbon sorption and two-pass RO with final filtration (Refer to [Section 12.1](#)), however similar arrangements that include single pass sanitary grade RO, EDI, final filtration, and ozonation may also be utilized where TOC can be reliably maintained below 200 ppb. High temperature distribution is not utilized for USP Purified Water and there is no specified endotoxin requirement. The increase in TOC (from 20 ppb to 200 ppb) is permissible for this USP Purified Water application where distribution systems are routinely (at least weekly) ozonated as a means of microbial control; however it is generally recommended to maintain the lower TOC levels. Where EDI is utilized with two-pass RO, it should be located before the second pass.

Non-compendial high purity water may (depending on application suitability) be used for facility washing/cleaning/rinsing and for tests and in assays used in analytical laboratories as well as, formulations of bulk active pharmaceutical ingredients (APIs). Non-compendial



water is validated in a manner consistent with compendial water.

Non-compendial water should be as appropriate to the application, however the treatment process shall include (at minimum) filtration, ion exchange softening, carbon sorption, either two-pass RO or single pass RO plus EDI, disinfecting UV, and final filtration. Such water should have less than 100 CFU/ml, less than 2 mS/cm referenced to 25°C (77°F), and in no case more than 500 ppb TOC. There is no endotoxin requirement for non-compendial water. With the exception of non-compendial water utilized only for general cleaning applications of non-critical surfaces, it is recommended that water be produced and maintained with TOC below 20 ppb, except that TOC levels up to 200 ppb may be acceptable where routine ozonation is incorporated.

For WFI water, an alert level of not to exceed 25 ppb and an action limit of not to exceed 100 ppb shall be utilized for TOC. Action limits for other parameters or for other compendial applications shall be determined by system design and application, but in no case exceed 80% of the monographed water quality requirement or values indicated in [Table 12.1.1](#), whichever is more stringent and as updated (but not to exceed these values) based on trend data of properly operating systems. Conductivity values in [Table 12.1.1](#) are stated as resistivity. There is no lower limit to conductivity (upper limit for resistivity) for pharmaceutical waters, except that pharmaceutical waters supplying incubators and certain other scientific equipment may have manufacturer-imposed limits (typically conductivity values that are not permitted to be less than 0.2 mS/cm referenced to 25°C (77°F) are acceptable). The establishment of alert and action levels must allow for monitoring of a parameter that may be trending out of control and corrective action prior to detecting an excursion.

The term “High Purity Water”, “HPW”, “HPWS”, and “HPWR” shall not be used without modification for pharmaceutical water supplies serving APFs due to potential conflict with water applications and systems in other areas of facilities. For example, where USP High Purity Water is utilized, “USP HPW” or “Pharmaceutical HPW” should be used for system identification.

Refer to [Chapter 12](#) for details on the pre-treatment options which shall be utilized for pharmaceutical water systems, including multimedia filters, carbon filters, softeners, cartridge filters, RO systems, EDI systems, UV systems, storage tanks, distribution system, sanitization systems, quality control and quality assurance and system startup. Refer also to [Appendix N](#) for additional guidance related to water testing and start-up. For WFI applications, off-line conductivity test shall not substitute for on-line conductivity and Anion/ Cation/ Metals/ Ammonia analysis. Comprehensive Installation Qualification (IQ) is mandatory for all compendial systems, including but not limited to use of qualified ultra-high purity (UHP) piping system contractors and 3rd party UHP piping system quality assurance during construction, and testing and to verify proper materials, purge gas, calibration reports, personnel and machine welding qualifications, test sample chain of custody documentation, etc. Where specified in compendium, the sampling and testing methods for specific parameters shall comply with the listed validation methods

Once IQ, OQ and initial PQ activities are complete, sufficient sampling and monitoring of compendial systems shall continue throughout the duration of an approved trend period sufficient to prove system stability. This trend period should typically not be less than 3 months, and at minimum shall be sufficient to include proven performance throughout upstream supply system source water changes, inclusive of at least 3 consecutive successful sample tests conducted over not less than a 6 week period for each water supply source. Example municipal sources that seasonally change from ground water to surface water, rotate supply sources for capacity issues or otherwise materially and routinely change their supply source or treatment process in a matter that may potentially effect source water composition. Subsequent off-line testing frequency and instrument calibration shall be defined on a site specific basis. Testing of compendial systems shall include off-line TOC, microbial, anions, cations, ammonia, and trace metals testing at least annually. At minimum, quarterly off-line testing shall occur throughout the first year, though monthly should be considered to establish trend stability. Presence of on-line instrumentation (e.g. TOC monitors) shall not substitute for off-line testing, or vice versa.



### 13.10.4 Drain and Vent System

APFs are sensitive to contamination which is common in drainage systems. For this reason, drains should only be present at the early stages of gowning and late stages of de-gowning, and in equipment/glass wash areas. Generally, drains should be avoided in ISO 8 areas. Drains are inappropriate for ISO 5 or ISO 7 areas, except where required for scientific use and approved by DTR. Where indirect waste drains are required and for any application where a floor drain is permitted, they shall be of sanitary, accessible, and readily cleanable design, constructed of not less than 316 stainless steel, with smooth surfaces and radius corners, self-draining without any retained wastewater, and shall be factory passivated.

Wherever possible, drains required for equipment and systems should be placed in a segregated routinely occupied and unconcealed area under negative pressure and accessible from outside the clean room. If the space cannot be accessed from outside the clean room, space should be provided for over-gowning and sanitization for entry and exit. Proper air-gaps shall be provided.

Where drains are required, they shall be provided with solid gas-tight gasketed covers. The drain and traps should be subject to a “drain/trap management program” which will include periodic sanitization and swabbing to assure control. Automatic electric trap seal priming is required, trap seal liquid shall be readily visible from the drain opening, and the use of mechanical or elastomeric trap seal devices (barrier type trap seal devices) is unacceptable.

High purity water sampling port drain and valve shall be located within clean space to mitigate contamination risk.

All traps shall have smooth, self-cleaning interiors (free of flat areas) to minimize the risk of soil accumulation and microbial growth. Deep seal traps are preferred to minimize risk of cross-contamination.

---

### 13.10.5 Sinks and Faucets

Drain-waste-vent (DWV) systems are a known source of contamination in APFs. For this reason, sinks should only be present at the early stages of gowning and late stages of de-gowning for hand washing, and in

equipment wash areas. Sinks are inappropriate for use in ISO 7 or ISO 5 areas, except where required for scientific use and approved by DTR.

Hand washing/hygiene sinks for APFs should utilize “hands-free” operation for water, soap and drying. Sensors, knee, and foot pedal operations may be acceptable, depending on site-specific requirements.

Sinks shall be not less than Type 316 stainless, NSF type, and without overflows. There shall be no sound deadening material applied to sinks in APF spaces. Faucets shall meet requirements of [Section 8.2](#) and [Section 13.10.2](#), however they shall be furnished without vacuum breakers unless specifically required for the application or risk (e.g. janitor faucets shall incorporate vacuum breakers). All faucet outlets shall project and terminate sufficiently above the flood rim and basin walls to facilitate complete washing without contact.

Janitor sinks should only be provided in Grade D or CNC spaces. Janitor closets within clean rooms should be for storage and mixing of cleaning materials only. Refer to [Section 13.3.4 Common APF Design Elements](#). Backflow protection for mixing of chemicals is required, and should be located in the accessible service space where possible. Where bleach is utilized as a routine disinfectant, janitor sinks should be acid resistant enameled cast iron.

---

### 13.10.6 Emergency Fixtures

Domestic water systems are a known source of contamination in APFs. For this reason, emergency fixtures should only be present in low classification spaces. Within ISO 5/7 rooms, the use of pre-sterilized portable eyewashes are preferred. Where an eyewash and emergency shower must be provided for safety within a clean room space, the safety equipment shall be clean room style and fully sealed and gasketed and constructed of stainless steel or other material compatible with cleaning chemicals. Where piped emergency fixtures are required, potable hot and cold water shall be piped to the fixtures with a point of use mixing valve, and fixture types shall be as addressed in [Section 8.2](#) and [Section 8.3](#). To minimize potential damage where emergency showers are required, utilize 75 LPM (20 GPM) flow restrictors unless otherwise mandated by

the application. The dedicated backflow protected water supply requirements of [Section 8.3.7 Emergency Fixture Water](#) shall be omitted where fixtures maintain appropriate air gap and do not incorporate hoses.

### 13.10.7 Liquid Nitrogen (LN<sub>2</sub>)

Cryogenic fluid distribution in APFs is typically limited to liquid nitrogen (LN<sub>2</sub>), the requirements for which are described in [Section 12.3](#). LN<sub>2</sub> is vital for maintaining temperature in cryo-freezers and controlled rate freezers. LN<sub>2</sub> systems shall have adequate capacity, pressure, flow, temperature stability, and monitoring to maintain operational continuity. LN<sub>2</sub> may be supplied from the bulk tank located outdoors, micro-bulk, or from dedicated cryogenic liquid containers (liquid cylinders) located nearby (but outside the clean room). All interconnecting piping between the supply source and freezers shall be made utilizing static vacuum jacketed piping and vacuum jacketed connection hose and fittings. Oxygen monitoring shall be provided in freezer rooms and other rooms where cryogenic fluids are supplied to warn of oxygen depletion. Remote liquid cylinders shall be provided with level monitoring displayed in the freezer rooms as well as other approved and constantly monitored locations. Supply source(s) shall include an emergency supply connection and an integral liquid cylinder reserve with automatic switchover. The stand-by reserve may be waived for liquid systems supplied by exterior bulk systems provided the arrangement incorporates telemetry, separate auxiliary alarm monitoring connected to the liquid level gauge, and provided the freezers and equipment served can maintain satisfactory operation upon unplanned loss of cryogenic fluid service for a duration of not less than 4 days. Automatic switchover arrangements shall maintain constant flow without depleting reserves during normal use, shall include a hot gas bypass to prevent warm gas from entering the system, and (where necessary) shall incorporate circuitry to maintain delivered fluid temperature stability. Where any cryo-fluid may potentially contact product, validation shall include contamination control of all wetted components including but not limited to particles, and such application shall be segregated from other non-critical uses.

### 13.10.8 Clean Compressed Gases

Compressed gas systems serving APFs may include, but are not limited to Carbon Dioxide (CO<sub>2</sub>), Nitrogen (N<sub>2</sub>), Argon (AR), Oxygen (O<sub>2</sub>), and Pharmaceutical Compressed Air (CA). Primary source equipment (e.g. compressors, filters, reserves, micro-bulks, controls, alarms, and cylinders) as well as distribution piping serving APFs shall be completely independent and fully segregated from laboratory, animal facility, and clinical systems. Critical (product contact) and non-critical system applications shall be fully segregated, as this substantially reduces risks, operational/ validation impact, and potential for disruption. For any case where the use of a shared APF system is permitted between critical and non-critical spaces, approved point of use filtration is required at any outlet whose fluid variability may have an impact on a critical quality attribute (CQA). Refer to [Section 12.3](#) for additional requirements for these systems, including Ultra-High-Purity (UHP) requirements.

The supply source for APFs gasses should be cryogenic/ liquid type wherever possible as this promotes purity and minimizes potential for contamination. This is especially advised for any application with potential impact on a product's CQA. NFPA-99 style liquid cylinder x liquid cylinder automatic supply manifolds as well as high purity liquid cylinder x liquid cylinder automatic switchovers may be used and shall be inclusive of any required vaporizers and economizers to provide reliable gas supply at required pressure and flow, and to minimize fluid losses. Fully automatic liquid-cylinder reserve manifold arrangements are required for system continuity and shall not be shared. Cylinders shall not be located inside classified spaces.

Where facility demands justify large exterior bulk systems, shared use is permitted only with dedicated cryogenic medical gas for human applications (only), and at minimum redundancy of vaporizers is required, as well as redundancy and segregation of pressure control valves and other primary equipment arrangements to ensure completely separate distribution from the bulk tank to the APF points of use.

The supply source shall be fitted with redundant (N+1) particulate filters and shall include a high purity gas purge station arranged to facilitate supply source cylinder and filter change outs to occur without induced

contamination. Sintered stainless absolute filter media or sterile gas hydrophobic membrane type PVDF or PTFE is recommended, except that filter media for oxygen applications shall not be constructed of stainless steel. The use of halogenated elastomers (including PTFE and Viton) is unacceptable at any point (e.g. manifolds) where pressure may exceed 3000 kPa (400 PSIG). Copper, nickel-copper or other appropriate media should be utilized for oxygen applications to minimize combustion risks. Where filtration is applied, the need for pre-filters shall be evaluated.

Where UHP quality gas is required for various analytical instruments (e.g. gas chromatographs), stainless steel point of use purifiers are recommended and shall include purge stations. For applications with direct product contact, provision of an approved point of use sterile gas filter (hydrophobic PTFE or PVDF) is required. Non-disposable filters whose variability may affect a product CQA shall be integrity tested.

As it is typical to experience variability of purity with high pressure gas cylinders (HPGs), the use of HPGs in lieu of a cryogenic source should be limited to small applications where the use of a liquid cylinder would be impractical, the capacity is deemed satisfactory, and the potential variability of gas quality is deemed acceptable for the application. HPG cylinders are frequently shown (upon individual cylinder analysis) to exceed contaminant levels identified in batch quality certifications and (as with all portable liquid and gas supplies) purity certifications do not in themselves represent assurance of particulate levels. The use of liquid cylinders also provides substantially more capacity than high pressure gas containers, thereby minimizing refill frequency and the associated maintenance and potential of contamination.

Gas systems serving critical areas and for any potential product contact within APFs shall be designed and constructed of stainless steel materials and components in conformance with [Section 12.3.7 Liquid and Gaseous Lab Nitrogen/Argon, Additional Requirements](#). Systems shall be arranged and constructed of materials to reliably deliver not less than Grade 4.5 fluid purity gasses for CO<sub>2</sub> and for applications in non-critical spaces, and not less than Grade 5.0 fluid purity to critical spaces, within the required particle limits. With regards to filtration, the provisions as indicated above apply in lieu of the filtration portions of [Section 12.3.7](#) or [Section](#)

### 12.3.8.

For non-critical applications with no product contact or potential impact to a CQA, conformance with [Section 12.3](#) via segregated local systems may, at NIH discretion be deemed adequate.

CO<sub>2</sub> is required in APF Cellular Therapy for various equipment located in Tissue Culture and equipment rooms, (such as incubators). The quality of CO<sub>2</sub> gas shall be of high purity similar or higher than USP Medical Grade, Anaerobic and shall be sampled at qualification to prove a required purity of at least 99% and in conformance with the USP monograph. CO<sub>2</sub> shall be supplied by a primary/ secondary automatic supply consisting of at least two liquid cylinders with vaporizer and economizer circuit. Due to potential of evaporation and considering criticality and duration of activities with incubators, the inclusion of an auxiliary short term high pressure gas back-up emergency reserve with gas heater as addressed in [Section 12.3](#) is highly recommended. For extremely small applications, an NFPA-99 type fully automatic gas manifold may be used for CO<sub>2</sub> supply, when sized in conformance with [Section 12.3](#) for local supply systems. A gas heater is required for CO<sub>2</sub> cylinder gas supply sources. For all gas cylinders (including CO<sub>2</sub>) Manifolds should switch and alarm before gas drops below 1725 kPa (250 PSIG).

Systems shall be constructed to maintain fluid purity, inclusive of particle limits and shall be validated upon completion as indicated in the [13.10.9 Pharmaceutical Compressed Air](#) for Pharmaceutical Compressed Air Systems. At minimum, the supply and distribution system shall:

1. Maintain the purity of the source gas to the point of use without reduction of quality.
2. Deliver not less than the monographed purity specifications under all conditions.
3. Provide for particle limits, moisture, and hydrocarbon limits that do not exceed those indicated in the following section for Pharmaceutical Compressed Air to Critical Spaces.
4. Fluid applications whose variability may affect a CQA shall also meet an appropriate microbial specification.

5. In the case of CO<sub>2</sub>, initial distribution system contamination testing is carried out prior to charging the system with CO<sub>2</sub>, by using a high purity surrogate, typically nitrogen or argon.
6. Alert limits shall be sufficient to prevent an excursion from monographed requirements and room/hood classification.

All materials within APFs shall be suitable for use within clean room spaces, inclusive of cleaning protocols and use of hygienic pipe hangers, supports, and penetration seals. The use of hoses (with the exception of cylinder connections) shall be avoided as these are frequently a source of contamination.

A comprehensive installation qualification process shall be provided and shall include, but not be limited to all welding, purge gas, materials, and control of potential contaminants (e.g. contractor purge gas filters) as well as record logs and review of calibration documents performed by competent independent quality assurance personnel.

Outlets shall be located to permit ready access for validation, and shall not be located near a potential water source. The word “Pharmaceutical”, “cGMP”, or other text as approved by NIH on a site-specific basis shall be provided in piping and equipment identification nomenclature to provide clear identification and minimize potential for cross connections.

Alarms shall be provided to monitor the status of the source supply, reserve, and other aspects including main line valve status as indicated for lab systems in [Section 12.3](#). The alarms shall indicate to the BAS to indicate loss of supply, equipment failures, and alert levels for critical process parameters. In addition to BAS, alert to a secondary monitoring system (typically the scientific monitoring system) is required for critical alarms. Specific details of all alarms shall be recommended by the design team and reviewed and approved by NIH. The appropriate alert levels shall be determined by the A/E and subject to NIH approval. Depending on application, trending may be required.

All systems shall be properly purged, cross-connection tested, and kept under dry nitrogen or argon charge until the final system fill gas purge and validation for use. Prior to use, gas concentration verification shall be conducted to verify proper fluid delivery at use points.

## 13.10.9 Pharmaceutical Compressed Air

In addition to the provisions of [13.10.8 Clean Compressed Gases](#), the provisions herein apply to Pharmaceutical Compressed Air.

Compressed air for APFs shall be provided from fully controlled, independent, local systems; in conformance with [Section 12.3 Compressed Gas and Cryogenic Systems](#) for lab air. For fluid services delivered within a critical area or with potential impact on a CQA, the minimum fluid quality shall be determined by site specific risk assessment and approval of NIH but shall not be of lower quality than required for the most demanding room/ hood where an outlet is located. The delivered air through the piping distribution system shall in no case be less stringent than:

1. ISO 8573-1:2010 Class 2:2:1 for ISO Class 7 and dirtier spaces.
2. ISO 8573-1:2010 Class 1:2:1 for ISO 5 spaces/ hoods.
3. Microbial count limits shall be determined by Risk Assessment, however there should be no microbial contaminants detected at ISO Grade 5, and action limits exceeding 5 CFU/M<sup>3</sup> are unacceptable for APF areas of ISO Class 7.
4. All compendial requirements for cGMP shall additionally be met for all applications which may contact a product or otherwise affect a CQA.

Air shall be sampled at qualification to verify attainment of required specifications. Piping systems inclusive of the purge gas utilized during construction shall be validated for particulate, moisture, and hydrocarbon contamination (and may require oxygen monitoring). Scientifically validated contaminant test methods utilized by a laboratory accredited in conformance with ISO 17025 by a signatory to the International Laboratory Accreditation Cooperation (ILAC) Mutual Recognition Agreement are generally acceptable within the appropriate limits of detection. Wherever possible, test methods should be as recognized by ISO 8573:2010 standards, ISPE, or SEMATECH published documents for high/ ultra-high purity fluids. Unless otherwise required, the following methods should be utilized:

1. **Particles:** Report as per ISO 8573-1:2010. Use laser or laser diode particle counter for systems that may contact a product or affect a product CQA, and for all applications where particle counts of sizes below 1  $\mu\text{M}$  are required. For non-critical applications where no particle count sizes below 1  $\mu\text{M}$  are required, ISO 8573-4 off-site lab analysis (filter media) may be utilized.
2. **Hydrocarbons:** Report as per ISO 8573-2 and ISO 8573-5 via off-site lab analysis of samples (typically gravimetric, flame ionization detection (FID), and gas chromatography. On-site FID may be used.
3. **Moisture:** Color-reactive detector tubes (Draeger tubes) following ISO 8573-3 from an accredited lab may be used for routine analysis provided the dew point requirement is not below 40°F/C pressure dew point. Use electrolytic cell or aluminum oxide hygrometer for on-site measurements of lower moisture requirements or for critical accuracy applications.
4. **Microbial:** ISO 8573-7 plate methods. Both aerobic and anaerobic testing may be required, as determined by risk assessment.
5. **Gaseous Contaminants:** ISO 8573-6. Field method color-reactive detector tubes may be used only within application sensitivity requirements. Lab analysis of gas samples is typically preferred.

Compressors shall be 100% oil-free, scroll, rotary screw/ rotary tooth, or oil-free reciprocating type. Dryers shall be desiccant type only. Air intakes shall be from the exterior and in conformance with NFPA-99. Continuous automatic type dew point monitoring, carbon monoxide monitors, delivered air pressure monitoring, redundant desiccant dryer and filtration/purification trains, as well as passivated stainless steel wet and dry receivers are required. Filtration shall be provided prior to entering the cGMP space.

Cylinder tank manifold requirements shall follow those indicated for N<sub>2</sub> and O<sub>2</sub> gas under [13.10.8 Clean Compressed Gases](#).

## 13.10.10 Vacuum

Vacuum is generally not required in Cellular Processing facilities. Where required in APFs, general vacuum requirements will follow [Section 12.4 Laboratory Vacuum Systems](#). Dedicated vacuum systems for each APF are required, except for extremely limited use applications where point of use diaphragm type vacuum pumps with appropriately filtered and piped exhaust is approved after completion of a comprehensive risk assessment.

Piping material within clean rooms shall be compatible with the cleaning regimen, generally 316 Stainless Steel (SS), with orbital weld, VCR, or ISO K-fittings. All materials shall be cleaned and capped for oxygen service. The need for decontamination provisions/ filtration shall be determined on a site-specific application, however, provision of a full air gap is mandatory at the equipment discharge to any drains.



# Section 13.11

## APF Design Requirements: Fire Protection

---

### Contents

13.11.0 Introduction

13.11.1 Automatic Sprinkler Systems



## 13.11.0 Introduction

All fire protection systems within the APF area shall be designed in accordance with latest NFPA edition, FM Global, Applicable Building Codes and the Local Fire Marshall. All fire protection system equipment, sprinklers, devices and materials shall be Underwriter's Laboratory (UL) listed and Factory Mutual Global (FM) approved. The use of aspirating smoke detection should be considered for sensitive APF areas and is subject to approval of the DFM. Such systems may be beneficial even where only permitted or utilized as supplemental systems providing a trouble indication (where not approved as primary detection). Where aspirating detection is utilized, maintenance requirements of qualified vendors should be evaluated during the design phase, including experience with cleanroom fire detection. See [Chapter 9](#) for general fire protection and suppression and fire alarm requirements as well as FM Datasheet 1-56.

Sprinkler heads throughout the area shall be of the quick-response type except in areas designated for standard response per the requirements of the DRM. Rooms within clean areas shall have airtight devices.

Where allowed by DFM, sprinkler piping systems shall be initially leak tested with gaseous nitrogen instead of water to mitigate the risk of damage to the APF, see [Chapter 9](#). Sprinkler heads with "gasketed" ceiling cover plates and cleanroom rings over concealed pendant sprinkler head are the industry-preferred type for cleanroom areas but, require the approval of DTR and DFM. Alternative arrangements as described in [Chapter 9](#) (typically for high containment spaces) can be utilized where necessary to meet DFM requirements and FM Data Sheet recommendations.

---

## 13.11.1 Automatic Sprinkler Systems

The type of fire suppression system utilized for APF areas shall be evaluated by project with DTR and the DFM. Fires in cleanroom spaces that activate even a single sprinkler can immediately result in substantial financial loss and months of operational impact. For this reason, single interlock cross-zoned preaction systems utilizing nitrogen-charged piping and specialized detectors for cleanroom environments are recommended. Where such preaction arrangement is not acceptable, APF areas shall primarily be protected by a wet-pipe sprinkler system. All new sprinkler piping shall be hydraulically calculated by the sprinkler contractor using up to date properly conducted flow test information. Design shall include not less than a 10% minimum safety factor below the available combined water supply curve.

# Section 13.12

## APF Design Requirements: Electrical

---

### Contents

13.12.0 Introduction

13.12.1 General Requirements

13.12.2 Normal Power

13.12.3 Emergency Power Systems

13.12.4 Wiring Methods

13.12.5 Power Quality

13.12.6 Lighting

13.12.7 Emergency Fixtures

## 13.12.0 Introduction

The objectives of the electrical design guidelines are to ensure compliance with the applicable standards, establish uniformity of design, achieve the best overall cost-effective installation, and construct an electrical system that is compatible with other building systems. The design of the electrical systems shall meet the program requirements while incorporating NIH's commitment to robustness, resilience, sustainability and energy-efficiency. In addition, the design of electrical systems shall meet all applicable requirements in [Chapter 10](#) and comply with the following additional requirements.

---

### 13.12.1 General Requirements

Lighting, power, and communication systems shall meet all current program requirements as well as provide for future growth. These systems must have ample capacity to meet future increased load demand and shall include provisions for the addition of future electrical loads as determined by NIH on a project-by-project basis.

All electrical systems must be designed for safety, long life, efficiency, economy, and maintainability. Appropriate life cycle cost analysis shall be performed to select materials and systems that yield optimum system life. The electrical system shall be designed and built to operate with means for proper maintenance to occur with minimal need for interruption of other services and areas. Electrical equipment within aseptic processing shall be cleanable, ledge and crevice free, non-shedding, and sealed.

A protection and coordination study shall be performed for the portion of the new equipment provided. The results of the study shall be the basis for selection of overcurrent device settings and fuse types for short circuit protection, phase and ground overcurrent protection, system selectivity and coordination.

Arc flash hazard analysis shall be performed during the Construction Administration phase. Associated labels shall be installed prior to the completion of the project. Refer to [Section 10.1](#) for additional requirements.

### 13.12.2 Normal Power

Provide dedicated normal power distribution for all APF distribution systems and designed to permit segregation of different types of loads to different panels i.e., motor loads shall not be connected to the receptacle panels. Panelboards shall be located in electrical rooms outside the processing or clean areas. Electrical distribution system supplying power to HVAC and motor loads shall be located close to the equipment served.

The distribution switchboard (or power panelboard) shall be provided with a (type-2) Surge Protection Device (SPD-2). The SPD-2 modules shall be integral to or mounted separately next to the equipment served.

All transformers shall be general purpose type specified to have copper windings and have a 115°C (271°F) temperature rise over a 40°C (104°F) ambient and a 220°C (428°F) insulation system. All transformers shall be located in areas where the manufacturer's ventilation requirements and the NEC working clearances are strictly adhered to.

All transformers shall be bonded to the plant/building ground grid and/or building steel with a green copper conductor sized per the NEC, but not less than #4 AWG.

Refer to [Section 10.2](#) for additional requirements.

---

### 13.12.3 Emergency Power Systems

The emergency power shall be provided to all life safety loads, legally required standby loads and optional standby loads, including, but not limited to those listed under [Section 10.3.1 Emergency Electrical Systems](#) and:

1. Supply and exhaust fans serving APF
2. EMS systems
3. APF Gas manifolds and air compressors
4. APF High Purity water systems
5. Terminal Units and Critical sensors and pressure monitors serving APF
6. Select electrical outlets in APF

## 7. Phone system

All new exit and emergency lighting systems shall be fed from the Life Safety distribution, and shall match building standards. Life Safety loads as required by NEC Article 700 shall have battery or UPS system backup.

Uninterruptible Power Supply (UPS) shall be required to serve 208Y/120V for sensitive controls and additional equipment, as indicated by NIH. The UPS power shall be provided from a new adequately sized UPS system; location to be coordinated with NIH. UPS power incoming feed shall include both normal and emergency power and include a manual bypass. Refer to [Section 10.3.1 Emergency Electrical Systems](#).

### 13.12.4 Wiring Methods

All individual branch circuits shall be provided with a dedicated neutral wire. No shared neutrals shall be permitted. Maximum of two (2) offices' convenience receptacles shall be connected per circuit.

Install all wiring in conduit, and the minimum size of the conduit shall be 21 mm ( $\frac{3}{4}$  in.) for power system wiring and 35 mm (1-1/4 in.) for telecommunication systems. Conduit application is as follows:

1. Feeders (Indoors): Feeders up to 103 mm (4 in.) in diameter and concealed within building construction shall be Electric Metallic Tubing (EMT).
2. Damp or wet locations: Hot dipped galvanized rigid steel conduit.
3. Lighting and receptacle branch circuits: Electric Metallic Tubing (EMT).
4. For connection to motors and vibrating equipment such as transformers, provide liquid-tight flexible metal conduit.

Conduits shall be installed concealed in ceiling and wall. Fittings for metallic conduits shall be compression type.

A minimum of one power receptacle shall be provided at each wall surface. Convenience receptacles shall be provided throughout the areas with the distance to a

receptacle from any location in the area being served no more than 15.24 m (50 ft.). Special receptacles at 120V, 208V and 480V shall be provided to serve specific equipment requiring more than 20A, 120V circuit as specified by the equipment manufacturer. Dedicated receptacles shall be located as close as possible to the equipment served. Outlets shall be labeled with the panelboard and circuits number of the branch circuit serving the outlet.

To accommodate to flexibility/interchangeability of freezer equipment requiring 20A 120V 1P or 20A 208V 1P circuit, a combination of (1) 208V and (2) 120V receptacles shall be provided next to each other and fed from a 2-pole circuit breaker in the equipment panelboard.

All devices located within clean areas shall be clean-room type, fully flush, sealed and cleanable, compatible with all required cleaning agents. This includes all horns, strobes, pull stations, and detectors. Covers alone are not considered adequate to make a device cleanable.

Cast device boxes with external hub and gasketed device covers shall be provided in cleanrooms to allow proper cleaning with a spray bottle and hand wipe or mop while in use and easy removal for service. Caulking devices to the wall, floor or ceiling shall not be allowed as a substitute for proper flush gaskets, except where specified by the device manufacturer and where removal is not required for service of the device (e.g. exit sign interface to ceiling or wall).

All devices shall be properly sealed to prevent the migration of air through conduits. Provide 25 mm (1 in.) barrier of silicone caulking around the wire within the device box hub; and provide a continuous bead of silicone caulk around the device cover plate and the adjacent surface.

Devices below covers shall also be resistant to cleaning and sanitizing chemical sprays. The A/E shall coordinate with the list of cleaning chemicals for compatibility requirements. Hands-free switches are preferred wherever applicable and should be used throughout. These switches are required for door controls.

Emergency egress buttons for all physically interlocked doors shall be waterproof simulated break-glass type with covers. All interlocked doors shall be equipped with sounders to notify when the egress button has been

used or the door open alert time has been exceeded. Refer to [Section 10.5](#) for additional requirements.

### 13.12.5 Power Quality

Panelboard serving nonlinear equipment shall be provided with 200% neutral bus to account for harmonic heating. Provide oversized neutral for all branch circuits supplying nonlinear loads and refer to [Section 10.6](#) for additional requirements.

### 13.12.6 Lighting

Complete lighting system shall be provided for all areas. The lighting system shall primarily consist of energy-efficient fluorescent and/or LED lighting fixtures. The lighting system shall be serviced at 277V for fluorescent/LED fixtures. For egress lighting, dual-voltage (120/277) ballast shall be provided. Lighting level required is shown in [Table 13.12.6](#) and [Section 10.7](#).

Where lighting devices are provided in clean areas, fixtures of all types shall be triple gasketed, smooth, cleanable and compatible with cleaning chemicals. Where lighting is integral with ceiling systems, the light lens and seals shall be provided by the ceiling grid manufacturer. Luminaires (fixtures) should have no areas from which contamination may be released or harbored. Sealed or flush fittings is preferred. Light fixtures should be serviceable and not create glare. Comfort to occupants must be considered as well as photosensitivity to product or materials that will be used.

Since light fixtures can have an impact on the air flow, these factors should be considered when positioning. A diffuser should be used to minimize or negate turbulence.

Lighting controls for open spaces shall be via occupancy sensors with manual step-switched override. Certain fixture circuits shall always remain on to serve as night-lights and as emergency egress fixtures, as required by local and national codes. These fixtures shall be by local and national codes. These fixtures shall be controlled from switch duty rated circuit breakers in the emergency lighting panel and ahead of local switch controls. Circuit breakers controlling fixtures shall be switching duty rated breakers.

**Table 13.12.6 Lighting Uniformity Requirements**

Type of Area, Task, or Activity	Lux-level (Em)	Color Temperature (CCT)	Glare rating (UGRL)	Uniformity (Uo)	Color Rendition (Ra)	Cylindrical Illuminance (Ez)	Specific Requirements
General Lighting	300 - 500	≥ 3,500 K	19	0.6	80		Illuminance at floor level
Equipment Rooms	325 - 540	< 6,000 K	19	0.6	80		Illuminance at floor level
Laboratory Support Areas	325 - 430	≤ 6,000 K	19	0.6	80		Illuminance at floor level
Difficult Inspection	1000	≤ 6 - 6,500 K	19	0.7	90	1,200 lx at 1.2 m	Illuminance at benchtop
Exacting Inspection	3 - 10,000	≤ 6 - 6,500 K	19	0.7	90	1,200 lx at 1.2 m	Illuminance at benchtop

## 13.12.7 Emergency Fixtures

A minimum of one emergency power lighting fixture shall be provided in each space, but additional fixtures could be required based on minimum of 10 lux (1 fc) for emergency egress. Low wattage LED type exit signs shall be installed as required by local and national codes. Exit signs and emergency/night lighting shall be provided by un-switched branch circuits, fed from the life safety/emergency lighting panels(s). Refer to [Section 10.7](#).



# Section 13.13

## APF Design Requirements: Low-Voltage Systems

---

### Contents

13.13.0 Introduction

13.13.1 Telephone and CIT Outlets

13.13.2 Closed Circuit Television (CCTV)

13.13.3 Information Technology

## 13.13.0 Introduction

The low voltage systems in APFs require the same high level of attention to detail as do line voltage systems. All back-boxes should be cast metal, and all conductor entries should be via sealed conduits. Cover plates should be gasketed and caulked. Other requirements are as described below.

---

### 13.13.1 Telephone and CIT Outlets

Telephone/data outlets/wireless outlets shall be located as required by the users and as described above in the lab surface metal raceway system. In addition, a minimum of one data outlet shall be provided at each wall surface. Each outlet shall include a box with a stainless steel cover plate and not less than a 35 mm (1-¼ in.) conduit to the cable tray. A pull string shall be provided to facilitate the installation of category 6 wiring. In addition to wall outlets, wireless LAN access point shall be provided throughout the space. Provide emergency and UPS power for the telephone/data systems. All boxes serving classified spaces shall be cast metal, sealed into the conduit with 100% silicone, and with a sealed and gasketed cover plate.

Cleanroom telephones should be accessible to minimize movement of personnel into and out of the cleanroom. Windows, speech panels, intercoms, data links and telephones shall be compatible with the cleanroom class and application.

### 13.13.2 Closed Circuit Television (CCTV)

All cleanrooms shall be equipped with CCTV cameras in wipe-down compatible covers to allow remote monitoring of all rooms. Camera locations shall be such that all portions of the room are visible via this system.

---

### 13.13.3 Information Technology

Provide two (2) redundant 208Y/120V 3P 4W panelboards and UPS in the LAN room for all of the communications systems. These panelboards shall be fed from circuit breakers located in the distribution equipment for standby power distribution.

Dedicated, wall-mounted copper ground bus shall be located in electrical and LAN rooms. These ground buses shall be connected to the existing ground bus located in the main electrical room. Refer to [Chapter 11](#).

# Section 13.14

## APF Design Requirements: Environmental Monitoring System (EMS)

---

### Contents

- |                                     |  |
|-------------------------------------|--|
| 13.14.0 Introduction                | 13.14.5 Alarm and Voice Access                         |
| 13.14.1 General Requirements        | 13.14.6 Controller                                     |
| 13.14.2 Equipment Monitoring System | 13.14.7 Temperature and Moisture/Humidity Transmitters |
| 13.14.3 Program and Graphic of EMS  | 13.14.8 Room Differential Pressure Transducers         |
| 13.14.4 Local Indicator             |  |

## 13.14.0 Introduction

This section describes the general environmental monitoring system (EMS) considerations, as well as the specific requirements. EMS shall be specified by the A/E in consultation with users and procured and validated under the construction contract. Once the EMS is validated, NIH users typically take ownership of this system. Refer to [Section 13.9](#) for HVAC Controls and BAS Requirements.

---

### 13.14.1 General Requirements

Critical HVAC environmental control parameters shall be monitored on an EMS system. EMS shall be complete, functional, tested and ready for IQ, OQ, PQ and Computer System Validation (CSV).

The EMS shall provide validated monitoring and alarming of critical environmental conditions, via dedicated, validated, probes within the compounding / manufacturing environment.

It is recommended that EMS and BAS be fully segregated; however, if approved by DTR, BAS and EMS may share common sensors. In such cases, the qualified portion of the EMS shall be firewalled off from the main BAS, with unique access control, security, change control, audit trail, calibration management, nonvolatile record creation and report generation, and be fully 21 CFR Part 11 compliant with the ability to be qualified and CSV validated.

Where separate EMS and BAS sensors are used, they shall be co-located to ensure the accuracy of the data. Generally, co-location should be interpreted as within 1 m (3 ft.), and at the same elevation, particularly for temperature sensors. Shared sensors must still be under calibration management and the systems isolated by an appropriate signal splitter or communication of the field data to the BAS from the EMS via an appropriate high-speed bus.

All EMS field devices shall be calibrate-able with NIST certified factory calibrations.

The EMS shall provide non-volatile electronic records of monitored conditions over no less than a 2 year period without recourse to archives and 7 years of archive storage.

Room monitoring of classified spaces shall be by the EMS.

This system should be complete, with all components, installation and services outlined herein and as needed to provide a functional system, including:

1. Field devices
2. Signal repeater/isolators
3. Controllers
4. Servers
5. Power supplies
6. Misc. components
7. Wiring
8. Software
9. Configuration
10. Startup/commissioning
11. Testing
12. Documentation

The functionality of this system should include, but not be limited to:

1. Temperature monitoring
2. Humidity monitoring
3. Room differential pressure monitoring
4. Alarming
5. Local and remote notification of alarms
6. Voice dialing notification of alarms

## 13.14.2 Equipment Monitoring System

Freezers, refrigerators, and incubators shall be monitored by a dedicated, validated equipment monitoring system (similar to REES) that is separate from the BAS system.

The equipment and EMS may be separate or combined system(s). If combined, no element of these requirements shall be compromised in combining the systems.

## 13.14.3 Program and Graphic of EMS

**A. Graphic Display:** Display graphic with minimum 20 dynamic points with current data within 10 seconds.

**B. Graphic Refresh:** Update graphic with minimum 20 dynamic points with current data within 8 seconds.

**C. Object Command:** Reaction time of less than 2 seconds between operator command of a digital object and device reaction.

**D. Object Scan:** Transmit change of state and change of analog values to monitoring units or workstation within 6 seconds.

**E. Alarm Response Time:** Annunciate alarm at workstation and local annunciator within 20 seconds. Multiple workstations must receive alarms within 5 seconds of each other.

**F. Program Execution Frequency:** Run capability of applications as often as 5 seconds, but selected consistent with mechanical process under control.

**G. Performance:** Programmable controllers shall execute DDC PID control loops, and scan and update process values and outputs at least once per second.

**H. Reporting Accuracy and Stability of Control:** Report values and maintain measured variables within tolerances as follows:

1. Space Temperature: +/- 0.5°C (1°F)
2. Relative Humidity: +/- 2 %RH.

3. Air Pressure (Space): +/- 2.5 Pa (0.01 in w.g.)

Fully implemented application and custom software, controllers, network interface and controls devices necessary to accomplish the sequence.

Collect data from connected hardware including panels, processors and sensors at least once per minute, unless approved otherwise by DFOM and DTR.

The system shall keep accurate records of the many data parameters, including analog parameters (like temperature and humidity) and digital parameters (like equipment failure alarms). Data readings are taken at user-defined intervals and stored in a database. This data can be later used in reports for verification of environmental conditions. If a parameter is critical to a facility's operation, the system can notify staff various ways via email or phone notification.

All work, materials and equipment shall comply with the guidelines and regulations, codes and ordinances of the local, state and federal authorities having jurisdiction. As a minimum, the installation shall comply with the current editions of the following codes:

1. 21 CFR Part 11
2. National Electrical Code (NEC)
3. Uniform Building Code (UBC)
4. Uniform Mechanical Code (UMC)

Provide a local analogue readout of analogue sensor values adjacent to or on the surface of all space mounted sensors.

Provide a Human Machine Interface (HMI) touch screen panel for operator interface with all system functions in the clean corridor or gowning space, as directed by the owner.

HMI shall be compatible with cleaning chemicals such as LPH, IPA, peracetic acid or hydrogen peroxide.

Provide a host computer/operator workstation with printer for operator interface, programming, troubleshooting and printing of alarm logs, reports, etc.

The system shall monitor equipment status based upon user designated run-time, starts, and/or calendar date limits, and generate maintenance messages.

Provide graphics for floor plans of the building. This includes each room monitored. Point information on the graphic displays shall dynamically update. Show all input and output points for the system on each graphic.

---

### 13.14.4 Local Indicator

Provide local Red/Amber/Green LED indication of monitored parameter status. Solid color, no flashing is required, single multicolor LED or “light stack” are acceptable.

Where mounted in cleanrooms, LED indicators shall be smooth and cleanable, suitable for cleanroom service. They shall also be compatible with cleaning agents, including sodium hypochlorite, hydrogen peroxide, peracetic acid and isopropyl alcohol.

Local annunciation shall be by means of LED indicators. These indicators shall be clearly visible in daylight and at all angles from a distance of 30 m (100 ft).

Room level monitoring and alarming shall be announced by local status indicators both within the cGMP manufacturing rooms and within the clean corridor.

---

### 13.14.5 Alarm and Voice Access

Provide acknowledgment provisions of alarm conditions, stop the alarm notification process and record name of user taking responsibility for the alarm, and the date/ time of acknowledgement at the System Server.

Allow alarm acknowledgement to expire after a user-defined period ranging from 2 hours to 3 days.

Provide optional provision to require user to complete an alarm checklist prior to alarm acknowledgment. Failure to complete checklist will result in alarm not being acknowledged.

Record and store information about alarm conditions.

Handle alarm and critical conditions by re-notification as values transition to critical.

Provide alarm delays ranging from 0 to 255 minutes to delay the start of alarm notification when current readings are within the alarm range. Ignore alarm delays during critical range.

Provide Clear Alarm delay ranging from 0 to 15 minutes to prevent the premature clearing of an alarm condition.

Provide filtering and signal conditioning to prevent erroneous alarms due to signal noise, floating grounds, faults, voltage spikes and other transient conditions.

Allow a user-defined clean interval ranging from 0 to 240 minutes to prevent report of alarm conditions during standard room cleaning procedures. Allow local activation of clean mode (LP). Log when clean is activated along with the name of the user responsible for activation.

Send alarm start messages to a designated e-mail address via SMTP. Construct a list of users to notify via e-mail from system user list and/or by direct entry of e-mail addresses. Message format to include location date, time, alarm condition and current reading. Acknowledge message format to include the name of the user acknowledging alarm and appropriate notes. Clear message format to indicate the duration of alarm.

Send alarm start message to user on alpha-numeric pager via SMTP.

Voice access and call-out allow the user to hear alarm message from the system server hosted system using a valid PIN.

Voice Access and Callout provide spoken information of alarm conditions via telephone.

Voice Access and Callout allow the user to review current reading associated with alarm conditions.

Repeat alarm messages at a user-defined interval range from 15 minutes to 8 hours.

Send alarm clear and acknowledge messages via all methods provided for alarm messages.



### 13.14.6 Controller

The controller(s) shall communicate with each other and operator workstations through a high-speed network utilizing ethernet TCP/IP, and to application specific controllers and third-party equipment controllers through a field level network bus.

The controller shall be able to operate at 90% to 110% of nominal voltage rating and below 80% nominal voltage, and shall perform an orderly shutdown. Operation shall be protected against electrical noise of 5 to 120 Hz and from keyed radios up to 5 W at 1 m (3 ft.).

Each controller shall be capable of stand-alone operation and shall continue to provide monitoring functions without being connected to the network for a period of no less than 7 days and shall retain programming in the case of power loss.

Controllers used outdoors and/or in wet ambient conditions shall be mounted within waterproof enclosures and shall be rated for operation at -40°C to 65°C (-40°F to 150°F).

Controllers used in conditioned space shall be mounted in dust-proof enclosures and shall be rated for operation at 0°C to 50°C (32°F to 120°F).

Provide 20% spare capacity. Utilization of spare capacity shall require providing the field device, field wiring, if required, point database definition, and programming. No additional controller boards or point modules shall be required to implement the use of these spare points.

### 13.14.7 Temperature and Moisture/Humidity Transmitters

Temperature and Moisture/Humidity Transmitters (TT & MT) shall meet the following criteria:

1. Accuracy: Temp 1%, RH 2% of full range
2. Range: 0 to 100% relative humidity
3. Drift: Shall not exceed 1% of full scale per year
4. Output Signal: 4 to 20 mA, linear
5. NIST traceable
6. Room Sensor Cover Construction: Cleanroom style smooth face cover
7. Duct Sensors: Suitable for operations at temperatures of -1°C to 60°C (30°F to 140°F) with element guard and mounting plate.

---

### 13.14.8 Room Differential Pressure Transducers

Room Differential Pressure Transducers shall meet the following criteria:

1. Accuracy: +/- 1.25 Pa (0.005 in. w.g.)
2. Range: +/- 62.5 Pa (0.25 in. w.g.)
3. Drift: Shall not exceed 1% of full scale per year
4. Output Signal: 4 to 20 mA, linear
5. NIST traceable

# Section 13.15

## Construction Phase

---

### Contents

13.15.0 Introduction

13.15.1 Contracting Officer's Representative (COR) Requirements

13.15.2 Construction Quality

13.15.3 Clean Build Requirements

13.15.4 Pest Management

13.15.5 Construction Submittals

13.15.6 Testing, Adjusting, and Balancing (TAB)

13.15.7 Commissioning Activities (Construction)

13.15.8 Factory Acceptance Test (FAT) & Site Acceptance Test (SAT)

### 13.15.0 Introduction

This section describes the additional requirements associated with the transition from Design through the Project Closeout and Facility Handover activities, inclusive of Construction, Commissioning and the execution of the Validation Master Plan (VMP).

At the time of this writing some, but not all NIH APFs have a well-developed set of current condition facility control documents, as defined in Chapter 13. Those which do not should leverage new construction projects to develop documents that meet these new standards.

Figure 13.15.0 shows the ideal construction phase scenario, where the existing facility has such a set of documents in place. Figure 13.15.0 describes the parallel path between Current Condition Facility Control Documents and APF Project Documents. The intent is to emphasize the need to keep the facility control documents current throughout the operation of a facility, even under planned outages and changes. The APF

Project’s existing condition description should be identical to the conditions described in the current condition facility control documents. The A/E will also describe the “after” condition, which should be identical to the post-construction current condition facility control documents.

In a new facility, or in the case where there is not a fully developed set of current condition facility control documents, the A/E’s existing conditions documents should be robust enough to be adopted as this set of documents. During the construction activities the IPT, working with the user group will develop one or more phases (particularly important when working on an active facility). Each iteration of changes, including altered PPE, flows of personnel, equipment, product, temporary barriers, etc., shall be accompanied by a change-controlled update to the current condition facility control documents. See Section 13.2, User Requirement Specification (URS) for a description of the current condition facility control documents. Additional facility documents, such as SOPs, etc., may require updating and be kept current

Figure 13.15.0 Ideal Construction Phase Scenario

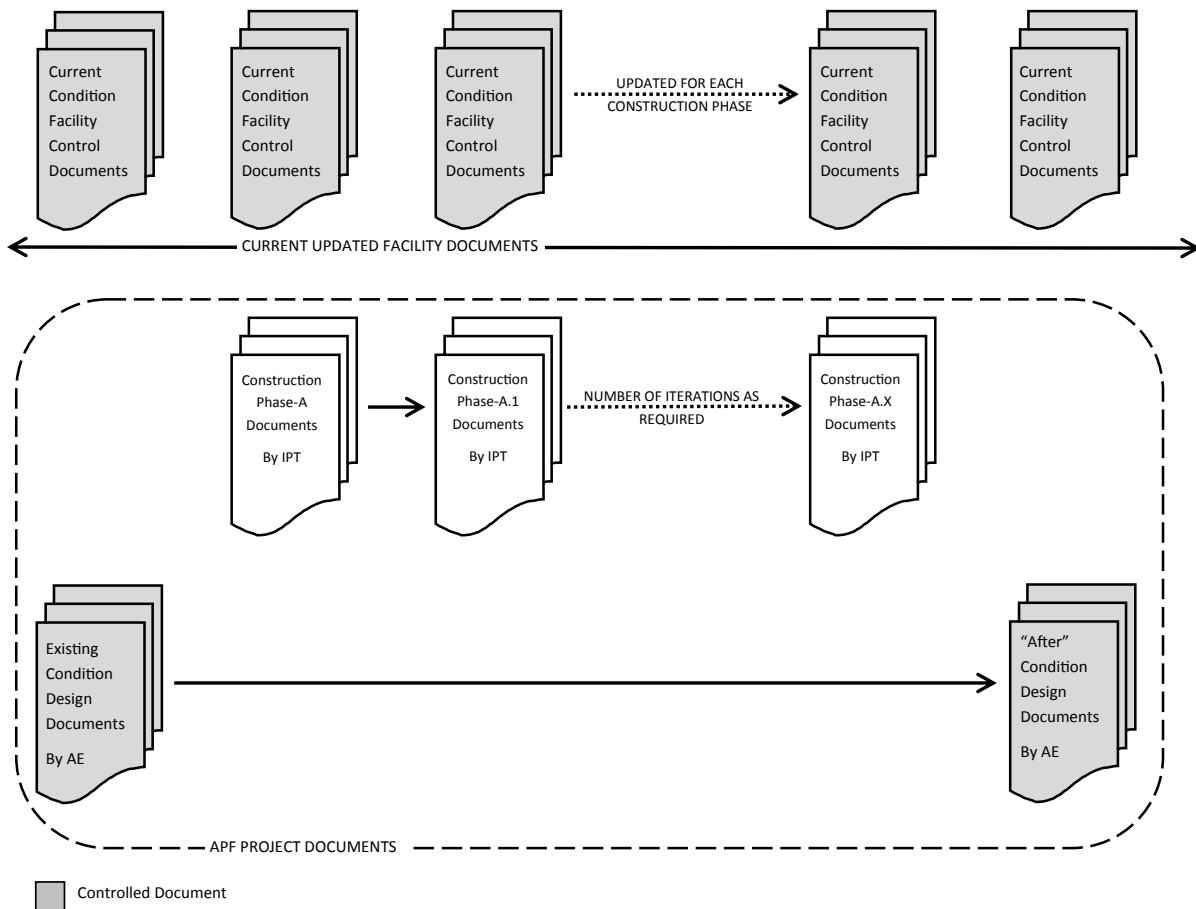

on a project-by-project basis, as determined by the User group and DTR/FCIS.

## 13.15.1 Contracting Officer's Representative (COR) Requirements

This section is not intended to be a construction management manual. APF projects, however, are highly prescriptive; requiring not just the management of the project but also the record keeping associated with the project. Construction management of an APF has additional requirements and responsibilities which are highlighted in this section.

The management of an APF construction project creates a higher burden on the COR, during design, and higher still, during construction, through facility certification. Although extra, these steps are mandatory, to ensure proper GMP facility validation. These responsibilities and restrictions typically include, but are not limited to:

For all APF projects the COR shall:

1. Ensure review and approval of the CQP, developed by the construction contractor, prior to construction start (See [Appendix E](#), and [Section 13.15.2 Construction Quality](#)).
2. Ensure the construction contractor provides coordinated work plan/drawings for review and approval by DTR/FCIS prior to commencing work.
3. Monitor, report, and document compliance with the CRA, ILSM, and clean build requirements daily.
4. Ensure/Incorporate the review of construction submittals by DTR/FCIS, which is supplemental to the submittal review process by the design A/E. See [Section 13.15.5 Construction Submittals](#).
5. Monitor for conformance with Clean Build Requirements. See [Section 13.15.3 Clean Build Requirements](#) for additional requirements.
6. Monitoring adherence of the construction

contractor to their CQP.

7. At a minimum, daily on-site inspections will be required, with additional inspections as dictated by the work being performed.
8. Manage Facility Certification Activities (i.e., Cx, Qx and Vx). Ensure proper training of construction personnel.
9. Witness tests and document results.
10. Manage the heavy documentation requirements by the IPT.
11. Compile Facility Handover Package.

For renovation projects:

1. The Construction Change Request, and associated work plan review and approval process will be in effect.
2. In a typical NIH construction projects, the COR has a level of control over the site, including hours of access, etc.; in APF Renovation projects, the Facility/User has final authority over who enters the facility, the work performed, and the timing of that work.
3. Access to the site may require training on the APF's PPE donning and doffing requirements. The PPE, and therefore retraining is subject to change, at the discretion of the Facility/User.

## 13.15.2 Construction Quality

**A. Construction Quality Plan (CQP):** The CQP is a document, created by the construction contractor, which sets out specific quality objectives, practices, resources, and sequences of activities relevant to a particular project.

A standard CQP may be listed as a requirement in the evaluation of construction contractors during acquisition, at the discretion of the COR. The construction contractor shall submit a project-specific CQP that defines the quality performance objectives and how to ensure conformance during the construction phase of a project. The CQP documentation must correlate with

the PVMP and address the following:

1. Quality assurance surveillance
2. Objectives and acceptance criteria of the work
3. Quality standards that apply to the work
4. Quality controlled worklist
5. Work instructions, process steps, and product installation instructions that apply to the work task
6. Required quality inspections and tests
7. Control of nonconformance(s)
8. Location of quality system records and documents
9. Project completion inspections
10. Definition of critical systems/ components and equipment (i.e., will have direct impact)
11. Document management program (i.e., submittals, RFIs, request for substitution, etc.); these documents become part of the validation plan
12. Quality inspections and test plan
13. Nonconformance report
14. Quality and management system for the receipt, inspection, and acceptance of equipment by the construction contractor. This ensures that what was received was per the design specs.
15. Management of installation and inspection of critical facility equipment (i.e., install of AHU, inspection, associated paperwork/ drawings, sign-offs by different trades)
16. Define contractor ‘turnover package’ of documents that is to be turned over to the government and the IQ/OQ/PQ.
17. Establish the scope and schedule of these activities.

The CQO is executed by the construction contractor

from prior to the start of construction on-site through the end of the construction phase. The output from this execution prepares the construction contractor for Cx, IQ and OQ. Output documents may include, but are not limited to the following:

1. Verify installation
2. Verify calibration
3. Verify sequence of operations
4. Perform loop checks
5. Perform facility training
6. Perform HEPA installation
7. Perform BAS alarm checks
8. Perform airflow and pressure tests
9. Perform air change rates
10. Perform system recovery tests

**B. Construction Qualification (CQ) Activities:** CQ is the execution of the CQP. It is a documented effort by the construction contractor and subcontractors to establish that they have completed their work (including internal setting, testing, and troubleshooting as necessary) and are ready for the third-party observed/led testing and documentation to commence. The intent of CQ is to accelerate startup, by reducing the time required for subsequent IQ and OQ activities.

Following are critical systems that should be inspected during the CQ of an APF project, where applicable:

1. Cleanroom HVAC
2. Purified water (WP) system
3. Water for injection (WFI) system
4. Computerized systems
5. Product contact compressed gases
6. Clean-in-place (CIP) systems
7. Product piping systems

## 8. Architectural finishes

CQ Documentation may include, but is not limited to:

1. Contractor training
2. Good documentation practices
3. Equipment and component verification
4. Redline drawing control
5. Startup
6. Air duct cleaning and inspection
7. Air duct leakage testing
8. HEPA filter installation
9. Piping system walk down procedures
10. Hydrostatic pressure testing
11. Pneumatic pressure testing
12. Cleaning and passivation
13. Documentation of conformance with clean build protocols
14. Pest management
15. Preliminary FAT/SAT

### 13.15.3 Clean Build Requirements

The contractor shall fully execute the clean build specifications throughout all construction phase activities. The clean build requirements are site and project specific, above and beyond any site-specific CRA and ILSM requirements and shall include, but not be limited to:

#### A. Contractor Training and Documentation:

1. Donning/doffing PPE
2. Exclusion of all food and drink (including bottled water) from site

3. Inspection and cleaning of tools and materials as they arrive at the site boundary

**B. Clean Construction Requirements (Level-I):** This level of clean build requirement correlates with demolition, framing, MEP rough-in, drywall, welding, major cutting and grinding activities, and similar heavy particle-generating work. Activities include:

1. Preparation of the area of work
2. Continuous broom cleaning
3. Continuous trash removal
4. Garmenting requirements (all jackets, hats, scarves and personal items are to remain outside of the construction area)
5. Negative pressurization, where it can be safely generated and maintained
6. Use of HEPA “air scrubbers” throughout work
7. Use of HEPA dust collection during cutting, grinding and similar particle generating activities
8. Frequent changing of sticky mats at all work area construction entrances
9. Floor protection installation and maintenance
10. Frequent wipe down and HEPA vacuuming of horizontal surfaces
11. PPE per OSHA, Contractor liability insurance carrier, general safety practices and as required by the APF to accommodate cleanliness requirements – typically shoe covers at this level.
12. A thorough construction cleaning, starting top to bottom, and from the most remote point back to the construction entrance of the facility is required to transition to Very Clean.

**C. Very Clean Requirements (Level-II):** These requirements build on the Clean Construction Requirements, listed above. This level of clean build requirement corresponds to the installation of wall and floor coatings, ceiling suspension rods, and grids, MEP terminals and similar work. Additionally:



1. Perform continuous cleaning (mopping, wiping, and HEPA vacuum, in lieu of sweeping).
2. No cardboard, wood, or other packaging materials shall be permitted in the APF.
3. PPE per OSHA, Contractor liability insurance carrier, general safety practices and as required by the APF to accommodate cleanliness requirements – typically shoe covers, hair nets, beard covers, and cleanroom gloves are required at this level.
4. A thorough construction cleaning, starting top to bottom, and from the most remote point back to the construction entrance of the facility, followed by a triple clean is required to transition to Ultra Clean.

**D. Ultra-Clean Requirements (Level-III):** These requirements build on the Very Clean Requirements, listed above. This level of clean build requirement corresponds to the startup of the air handling equipment and progress towards final pressurization relationships; installation of modular walls; cleanroom ceiling tiles; completion of fire sprinklers; finish MEP work, including HEPA/ULPA installation; and perform IQ/OQ/PQ.

1. Perform continuous cleaning (mopping and wiping with cleanroom mops and chemicals, and HEPA vacuuming).
2. No welding or grinding operations will be permitted, either above the ceiling or within the area of work. Such work, if required will be done elsewhere and cleaned before bringing into the area of work.
3. Clean wall panels prior to, and after installation to remove dust and other foreign materials.
4. All equipment and materials must be unwrapped and wiped down with approved cleaning supplies at the designated material “wipe down” area before they are permitted to enter the area of work.
5. PPE per OSHA, Contractor liability insurance carrier, general safety practices and as required by the APF to accommodate cleanliness requirements – typically shoe covers, hair nets,

beard covers, masks, cleanroom coveralls, and gloves are required at this level.

6. A triple clean, starting top to bottom, and from the most remote point back to the construction entrance of the facility is required to transition to operational readiness. After this triple cleaning, the facility is typically allowed to run for some number of days prior to ISO classification testing to further drive-down viable and non-viable particle counts.

Some APFs may require more levels than the three outlined above.

---

## 13.15.4 Pest Management

APF shall be maintained pest-free because of the sensitive nature of these facilities; however, pests should be deterred and destroyed (prior to entry to the facility), without the use of chemicals to the extent practicable.

Integrated Pest Management (IPM) is the NIH preferred methodology, but its goal is management in lieu of elimination of pests. In APFs, elimination must be the goal. The approach should be perimeter-based, in lieu of room-by-room.

Effective pest management requires the following:

1. Maintain strict cleaning and sanitation protocols
2. Eliminate harborage
3. Food and drink are strictly prohibited from all APF, even in unopened, sealed containers. This prohibition includes bottled water.
4. Inspections

---

## 13.15.5 Construction Submittals

Construction submittal review is part of the IQ process. There are more reviewers, providing a higher level of

scrutiny to APF project submittals, particularly submittals of critical systems and components than a typical NIH project (e.g., comparable to a BSL-3, in this regard). During the design phase, the IPT shall identify the critical components of the project. APF project submittals shall be submitted (to the DTR Intake Center) for review and comment after A/E's review and approval. Review and approval process by DTR does not replace the review and approval process required by the A/E. See [Table 13.15.5](#).

**A. Construction Submittal:** Typical construction submittals include shop drawings, material data, samples, and product data. Submittals are required primarily for the A/E to verify that the correct products will be installed on the project.

**B. Testing Documentation:** This is defined by the CxA and includes the range of inspections, adjustments, measurements, and tests that shall be carried out to ensure that each part of the installation complies with the design specifications.

1. **Functional Testing:** A series of tests and measurements that shall be carried out to determine, verify and document that all parts of the installation operate together to achieve required conditions in the "as built" or "at rest" states, per the design specifications.
2. **Operational:** A series of tests and measurements, carried out to determine and verify that the complete installation achieves the required 'operational' performance with the specified process or activity functioning, and with the specified number of personnel present (dynamic) working in the agreed manner.

This testing demonstrates conformance with the requirements for IOQ as well as testing the facility for dynamic conditions. These documents (raw data) may be leveraged by the TAB contractor, CxA, and VxA to develop their reports.

**C. Shop Drawing:** Shop drawings are a subset of construction submittals; they are a set of drawings produced by the contractor or vendor for the installation and coordination between architectural, structural, mechanical, electrical, plumbing, and fire protection

trades during the construction. Shop drawings provide the necessary geometric data to facilitate coordination between trades and schedule.

For APF projects, each construction submittal should provide the following:

1. A unique submittal identification number
2. Identification of the component and description
3. As applicable, provide component identification per the P&ID or other process drawings.
4. Indication of whether it is a, or is part of a critical component
5. Identification of the specification section which addresses the component
6. Attach supporting vendor technical literature with specific models and options selected clearly indicated.
  - a. In a "Specified Attribute" column, list the critical attributes of the component as indicated in the applicable specification, such as manufacturer, model number, materials of construction, capacity, etc.
  - b. In an "Actual Attribute" column, enter the component information for each of the critical attributes.
  - c. In a "Deviation Attribute" column, enter the component information for each of attributes which deviate from specification to enable reviewers to make an informed decision on the acceptability of the component.
  - d. In a "Quality Risk Management (QRM)" section, summarize risks and associated impact analysis. On a form, rate the impact of the submission on product quality, safety, and purity, and on the safety of personnel and equipment. Evaluate the proposed (or in-place) mitigation measures to control those risks.

- e. Identify the qualification and validation requirement(s) of the submittal (i.e., IQ/OQ/PQ, etc.)

---

## 13.15.6 Testing, Adjusting, and Balancing (TAB)

In APFs, testing, adjusting and balancing (TAB) activities are performed during commissioning of the project. A TAB may be performed at a defined periodicity during operation of the facility, as set forth in the facility SOPs.

The TAB shall be performed per the National Environmental Balancing Bureau (NEEB), Procedural Standards for Certified Testing of Cleanrooms (CPT Procedural Standards), 2009 – latest edition.

During construction, TAB is initiated when the CM informs the TAB contractor that system is ready for startup. The CM then assists the TAB and Cx vendor to complete TAB as part of Cx.

The TAB Acceptance Criteria (a range of acceptable values) is typically +/-10% of the design airflow value. This is commonly measured at the supply and may be calculated as ACH, depending on the design requirements. The exhaust and return air from any space shall be balanced to provide proper pressurization. This requirement shall supersede the engineer's air balance calculations.

---

## 13.15.7 Commissioning Activities (Construction)

During the Construction phase of the project, the various quality plans (i.e., PVMP), are executed. There is no universal order or sequence for the execution of the multiple plans that comprise an APF project. Similarly, there are few clear demarcations between plans, and often they are executed concurrently, or nearly so. The governing framework for all facility certification task(s) is the Project Validation Master Plan (PVMP), which defines the testing, sequence of testing and documentation requirements for all of its composite plans, and those executed by others.

**A. System Level Impact Assessment (SLIA):** The SLIA should be reviewed and approved before the start of construction. See [Section 13.16.1 Validation Master Plan \(VMP\)](#).

**B. Commissioning Master Plan (CMP):** The CMP is executed by the Commissioning Authority (CxA), Execution begins prior to the start of construction on-site. The output from the execution of the CMP is typically leveraged by the VxA to create the execution documents described in the PVMP. See [Section 13.16.3 Commissioning Master Plan \(CMP\)](#).

1. Verify room pressurization mapping
2. Qualify system recovery test
3. Execute the factory acceptance test (FAT) and site acceptance test (SAT). See [Section 13.15.8 Factory Acceptance Test \(FAT\) & Site Acceptance Test \(SAT\)](#).

---

## 13.15.8 Factory Acceptance Test (FAT) & Site Acceptance Test (SAT)

Major system components and all Modular Unit Systems (MUS) shall, at the PO/COR's discretion, be subject to Factory Acceptance Testing (FAT). FAT is intended to assure that all major components are fit for purpose, prior to shipment to NIH. FAT allows for the execution of some commissioning and qualification protocols, prior to delivery. On-site specific tests (i.e. fire alarm testing, etc.) are excluded from FAT, however, performing basic functional and software testing are strongly recommended.

**A. Factory Acceptance Test (FAT):** The COR and/or designee, authorized by the CO shall witness the execution of the FAT. The end-user, DFOM, DFM, CxA, VxA, and/or others may also attend/observe the FAT, at the discretion of the COR. For large modular facilities, the FAT is a milestone project date, signifying that the manufacturer believes that a component is compliant with the SOW and URS, and ready for shipment to NIH.

The protocols for testing shall be submitted for review

and approval by NIH prior to the FAT date. The acceptance criteria shall be clearly articulated in all test protocols. Typical inspections and testing conducted during the FAT include, but are not limited to completeness and quality of construction; compliance with safety regulations; ergonomic requirements; conformity to GxP requirements.

The component, equipment, and systems should be fully pre-tested by the manufacturer/fabricator before the witnessed FAT. The FAT shall test all equipment and systems as specified in the PEP. The SAT shall re-test all equipment and systems as the FAT as well as any additional tests as specified in the PEP, which may also include components installed on-site and/or other tests which are impractical or moot to conduct as FAT.

During the FAT, the manufacturer shall compile a document that reflects the PEP, URS, and PVMP documents. The executed FAT shall fully document the tests performed, including all certifications, reports, etc. Any corrective actions required will be fully documented and retested after mitigation.

Typical equipment receiving FAT include, but are not limited to:

1. Air handling units (AHU)
2. Compendial and RO/DI water systems
3. Prefabricated modular cleanroom systems
4. Decontamination systems
5. Autoclaves
6. Washers
7. Boilers
8. Electrical gears
9. Emergency generators
10. UPS
11. BAS
12. EMS
13. CCTV
14. Intercom

15. Door interlocks and red/green indicator lamp systems
16. Waste disposal systems
17. Chillers
18. Pumps
19. Cooling towers
20. Heat exchangers
21. Exhaust fans
22. Energy recovery
23. Bottled gas systems
24. Vacuum systems
25. Liquid gas systems

A punch list shall be initiated at the FAT, and corrective actions identified. This list shall be maintained current.

Division of Fire Marshal (DFM) requirements for FAT:

1. NIH DFM must review and approve fire protection shop drawings before any system installation begins.
2. Prior to the FAT the contractor must hire a licensed third-party Fire Protection Engineer (FPE) to inspect the sprinkler and fire alarms systems prior to ceiling close-in at the factory.
3. Fire alarm installation must be inspected at rough-in for compliance with NFPA 72 and NIH DFM approved shop drawings.
4. Sprinkler installation & hydrostatic test must be certified using the NFPA 13 test certificate for the factory-installed portion tested.
5. Photos must be taken of all areas before close-in and submitted to NIH DFM for record. Label photos to delineate areas shown.
6. FAT must include pre-delivery inspection by the licensed third-party FPE.

**B. Site Acceptance Test (SAT):** Shipping to the site typically requires breaking-down the component from its FAT state, shipping it to the site, moving it into place, and connecting it to site utilities. This transit

process subjects the component to unusual stresses. Site Acceptance Testing (SAT) is required to demonstrate that the component has been readied for use, and any required corrective actions have been satisfactorily completed. Include repeating many/all FAT tests to ensure damage did not occur during transit and that the site installation has been successfully accomplished.

During the SAT, the manufacturer shall update their FAT-phase document that reflects the PEP, URS, and PVMP. The executed SAT shall fully document the tests performed, including all certifications, reports, etc. Any corrective actions required will be fully documented, and retested after mitigation. Additional scrutiny should be given to FAT corrective actions during the retest. A SAT punch list will be developed and executed prior to acceptance.

At the completion of the SAT, the Owner's validation shall be initiated, including IQ, OQ, and PQ. The FAT punch shall be maintained as current. Any new corrective actions identified during SAT shall be added to the punch list until the PO/COR has accepted all items as corrected.

All pre-manufactured systems shall be subjected to SAT. Site acceptance tests are intended to assure fitness for purpose prior to acceptance of equipment or systems.

SAT includes execution of commissioning and qualification requirements and other tests as outlined in the system or equipment specification.

Typical inspections and testing conducted during the SAT include repeating many/all of the FAT tests to ensure damage did not occur during transit and that the on-site installation has been successfully accomplished.

Division of Fire Marshal (DFM) requirements for SAT:

1. The SAT must be used for all other fire protection systems and remaining portions of factory-installed systems.
2. The responsibilities for the tie-ins between factory and site-installed systems must be clearly delineated and documented in the PEP.
3. The SAT must include performing:
  - a. A complete fire alarm test witnessed by DFM. Contractor to provide NFPA 72 Completion Certificate.
  - b. A full hydro test of sprinkler systems. NIH is aware of the risk of full hydro testing on-site, including factory installed portions already closed in. This is, however, the NIH DFM approved method to test the tie-in. The contractor must certify using the NFPA 13 test certificate for the remaining portion tested.
4. Site-installed portions and any tie-ins must remain visible on-site until all inspections, including hydro testing, are done.

At project turnover, all nonconformities must be satisfactorily resolved, either through corrective action or acceptance via change control and recorded in the URS and other documents.

**Table 13.15.5 APF Document Review and Approval (Construction)**

Document	Signed	Controlled	PO/COR	Per DRM Section 1.5.3.3	FCIS	ORSC	DFOM	NIH Program (User)	User QA	External Regulatory Agencies
Project Execution Plan (PEP)*	•		IRS		R	R		RS	R	
User Requirement Specifications (URS) *	•	•	R	R	RS	RS		IRS	RS	R
Basis Of Design (BOD) *	•	•	IRS	R	RS	RS		RS	RS	R
Quality Risk Management (QRM) Report, as needed	•		R		RS	RS		IRS	RS	R
VE and Sustainable Design Analysis, as needed			IRS	R	RS	R		RS	R	R
Piping and Instrumentation Diagrams (P&ID)			IRS	R	R	R		R	R	
Final Design Contract Documents (Dwgs., specs., etc.) *	•	•	IRS	R	RS	R	R	RS	RS	
FDA meeting document package(s), if applicable	•		R	R	R	R		IRS	R	R
Project Validation Masterplan (PVMP) *	•	•	IRS	R	RS	R	R	RS	RS	
Commissioning Masterplan (CMP) *	•	•	IRS	R	RS	R	R	RS	RS	
Test Protocols as applicable per DRM Section 13.17. X	•	•	IRS	R	RS	R	R	RS	RS	
SAT/FAT Protocols, where applicable *	•	•	IRS	R	RS	R	R	RS	RS	
SOPs for Construction Phase *	•	•	IRS	R	RS	R		RS	RS	
Construction Quality Plan (CQP)	•	•	IRS	R	RS	R		R	R	
Construction Submittals			IRS	R	R	R		R	R	
DFOM Training Plan	•	•			RS		IRS			
Facility SOPs (for existing/operating facilities)	•	•		R	RS		IRS	R	R	
SOW for Construction, CxA, VxA, etc.	•		IRS		R		R			

\* Updated as Needed

I Initiated By

R Reviewer

S Signatory

**Note:** Unless indicated otherwise, PO/COR is responsible for the management of the above document(s).



# Section 13.16

## Facility Commissioning, Qualification, and Validation Phase

---

### Contents

- 13.16.0 Introduction
- 13.16.1 Validation Master Plan (VMP)
- 13.16.2 Project Validation Master Plan (PVMP)
- 13.16.3 Commissioning Master Plan (CMP)
- 13.16.4 Qualification Plan (QP)
- 13.16.5 Integrated Commissioning, Qualification and Validation (CQV) Services

## 13.16.0 Introduction

This section describes the roles and responsibilities in Commissioning (Cx), Qualification (Qx) and Validation (Vx) related activities of operational APFs. The purpose of Cx and Qx is to provide assurance (by proving and documenting) that the facility, its systems and equipment have been properly designed, installed and tested for conformance with pre-determined acceptance criteria to meet the design requirements for the APF.

The purpose of Vx is to provide documented assurance that the methodology and execution of commissioning and qualification meet the GDP requirements for the facility; that the facility meets the predetermined acceptance criteria; and that the performance of the facility conforms to the GxP requirements for the product being produced.

---

### 13.16.1 Validation Master Plan (VMP)

The VMP is a user initiated, high-level document which establishes an overarching validation for the entire project, to be used as guidance for resource and technical planning. The VMP addresses both facility and other activities, such as gowning, cleaning, production materials, process validation, etc.

The VMP establishes the philosophy and principals involved in qualifying a facility by defining the areas and systems to be validated and provides the written program for achieving and maintaining a qualified facility. The VMP is used to develop the PVMP.

---

### 13.16.2 Project Validation Master Plan (PVMP)

The PVMP is a prescriptive set of documents, compiled and executed by the Validation Authority (VxA) that define the rationale and strategies associated with the facility quality assurance requirements of an APF project. All APF projects shall have a PVMP, developed during the design phase and progressively updated during design and maintained throughout the life cycle

of the project.

The PVMP is developed during the design phase and becomes a signed, change controlled document upon acceptance of the final design-phase submission of the PVMP (parallel with the final design submission of the construction documents). The PVMP is executed during the construction phase of the project and completed by the end of the project closeout and facility handover phase.

The PVMP shall:

1. Define direct, indirect and no-impact systems
2. Describe the following with precise technical language and illustrations, as required:
  - a. Qualification philosophy and testing rationale
  - b. Quality Assurance/Quality Control procedures
  - c. Test procedures
  - d. Acceptance criteria
  - e. Areas and systems to be validated
  - f. Testing plan
  - g. Deliverables
  - h. Provide a written program for achieving and maintaining a qualified facility

If the methodologies and rationale of the PVMP differ from the DRM requirements, the rationale behind the alternate approach shall be documented appropriately and submitted as a variance to DTR for review and approval.

All facility validation associated activities shall be planned, executed, and documented in accordance with the PVMP. The PVMP is comprised of a number of component activities, and documents, chief among these is the Commissioning Master Plan (CMP).

The PVMP is updated during design up to the point of execution, which begins in the construction phase. The validation authority (VxA) should have the introduction, scope, and facility description well underway by this stage, if not approaching the final draft level.

See [Section 13.16.1 Validation Master Plan \(VMP\)](#) and below:

1. Validate execution of IQ
2. Validate execution of OQ
3. Validate execution of FAT/SAT
4. Validate calibration
5. Validate loop checks
6. Validate completion of SOWs
7. Validate completion of facility training
8. Validate HEPA installation and integrity tests
9. Validate BAS alarm checks
10. Validate airflow and pressure tests
11. Validate air change rates
12. Validate qualification of ISO classifications
13. Validate system recovery tests

The PVMP is comprised of many component plans, and shall generally be organized into a final report as follows:

**A. Introduction:** The introduction should include the name, location, division and sector served. All qualification and validation activities should be planned and take the life cycle of facilities, equipment, utilities, process and product into consideration. A quality risk management approach shall be used for qualification and validation activities. Provide a short overview of the project and a cross-reference to the relevant quality assurance policy.

**B. Objective:** The objective defines the focus of the validation effort in clear, concise, declarative language

**C. Scope:** The scope defines the boundaries of the qualification/validation effort covered by the PVMP. Provide a brief description of the installation, whether single- or multi-product, and a breakdown of installed equipment as new or existing.

**D. Facility Description:** The facility description includes the facility characteristics such as the number of floors; the inter-connectivity of process and utility systems;

isolation means; the design product and Process Flow Diagrams (PFDs) depicting the anticipated personnel, raw material, process, and waste material flow used to minimize cross-contamination; cleanroom ISO classification levels; specialty surfaces and details integral to achieving the required product quality.

**E. Facility and Utilities Qualifications:** These describe the qualifications seeking to be obtained/maintained in the facility following the current validation effort.

**F. Key Acceptance Criteria:** These describe the conditions that the validation effort must satisfy to be accepted as fit for purpose by the user; these criteria may be at or above the minimum regulatory requirements determined during GxP harmonization.

**G. System Level Impact Assessment (SLIA):** The System Level Impact Assessment intends to identify those systems that have the highest risk to product quality and provide the appropriate level of attention by SMEs and other appropriate stakeholders. Based on the listing of equipment, controls, and systems, a SLIA shall be performed. The classification of systems (e.g., as "Direct Impact" or "Indirect Impact" systems) should be clearly outlined, supported by explicit rationale and be reviewed and approved by:

1. ORSC (Review Only)
2. DTR/FCIS (Review Only)
3. User Group
4. User Group Quality Assurance

**H. Commissioning Master Plan (CMP):** See [Section 13.16.3 Commissioning Master Plan \(CMP\)](#) Commissioning Master Plan (CMP). Alternately, if the project utilizes a combined commissioning and validation methodology, see [Section 13.16.5 Integrated Commissioning, Qualification and Validation \(CQV\) Services](#).

**I. Qualifications:** Per [Section 13.16.4 Qualification Plan \(QP\)](#), and below:

1. Design Qualification (DQ), if required
2. Installation Qualification (IQ)
3. Operational Qualification (OQ)
4. Performance Qualification (PQ), if required

**J. List of Required Protocols & Procedures:** All testing shall be performed per an approved protocol and testing results and documented. ISO 14644 protocols for testing shall include but are not limited to, the following:

1. Cx testing protocols (See [Section 13.16](#))
2. HEPA filter testing protocol
3. AVS protocol
4. Qualification (IQ/OQ/PQ) protocol
5. Airborne particle test protocol
6. Room temp uniformity protocol
7. Lighting illuminance uniformity test protocol
8. Viable/non-viable particle count test protocol
9. Cleaning integrity test protocol

**K. List of Relevant SOPs:** All Standard operating procedures (SOPs) developed for the APF testing, O&M.

---

### 13.16.3 Commissioning Master Plan (CMP)

The CMP is a component of the PVMP. Commissioning is a well-planned, documented, managed, quality-oriented engineering approach to the startup and turnover of facilities, systems and equipment to NIH that results in a safe and functional environment that meets established design requirements and stakeholder expectations.

The CxA shall develop the CMP during the design phase and coordinated with the PVMP. The CMP describes the engineering approaches and practices involved in activating/energizing, testing, and tuning the systems to be commissioned at the APF. The CMP also describes the test schedule, protocols, and organizes the data collected to assure that the construction conforms to the design drawings and specifications. The CxA executes the CMP during the construction phase of the project.

Refer to [Section 1.10 Commissioning](#) for additional requirements. For APF projects, the VxA may leverage data collected in the execution of the CMP for the execution of the PVMP. For APF projects, the Project

Closeout and Facility Handover Project Closeout and Facility Handover Phase do not conclude with the execution of commissioning, rather it continues through NIH's review and acceptance of the executed PVMP.

The following are generally required components of the Cx process, but may vary depending on the project:

1. Develop Commissioning Master Plan (CMP) in coordination with the Project Validation Master Plan (PVMP)
2. Verifying (through documentation) that material used for construction meets the specifications
3. Conduct checks to installed systems prior to energizing
4. Verify that systems perform to meet the design specifications for:
  - a. Sequence of operations
  - b. As-balanced airflow diagram
  - c. Room integrity test
  - d. Classification of rooms
  - e. General airflow patterns
  - f. Temperature mapping
  - g. Room pressurization mapping
  - h. Alarms, warnings, and recorders
  - i. Interlocks
  - j. Operation under failure scenarios
  - k. System recovery
5. Lead loop tuning effort to optimize the performance of commissioned systems

The CMP is the document which sets forth the Cx execution plan. The CMP addresses the entire commissioning team. The following are generally required components and content descriptions of the CMP, but these may vary depending on the project:

1. **Roles and Responsibilities:**
  - a. Defines the Cx team members, roles and

- responsibilities
  - b. Sets Cx procedures and methodologies
  - c. Establishes communication and management tools relating to Cx
  - d. Defines Cx deliverables and schedule
2. **Risk Assessments:**
- a. For the construction of APF projects, in a healthcare, laboratory, or mixed use building, the performance of each system may affect the performance of other systems, many of which are critical support systems for other patient care or research activities. A comprehensive understanding of the potential impact of commissioning activities is essential, including back-out planning.
3. **Extent of Commissioning:** Cx shall include acceptance criteria for each system to be commissioned, coordinated with the URS.
- a. Architectural/Structural: Accessibility and operational safety; doors and hardware; specialty/high-performance coatings
  - b. Mechanical: HVAC systems; HVAC control systems (BAS); environmental monitoring systems (EMS)
  - c. Plumbing systems: water systems; DWV systems; compressed gas systems; vacuum systems
  - d. Electrical systems: low voltage (below 750 V) distribution systems; standby and uninterruptible power, battery systems; lighting controls, equipment and distribution systems; lightning protection systems
  - e. Low voltage systems: voice communications and audio/video systems; electronic data and communications information systems; intrusion detection and access control systems
  - f. Life safety systems: fire suppression and fire protection systems; fire exit emergency signage; emergency power, emergency
- lighting.
4. **Fully Executed Documents in the final Cx Report:**
- a. CMP summary report
  - b. Cx schedule
  - c. Cx specifications
  - d. System readiness plan, checklist and report
  - e. A/E's pre-startup inspection report
  - f. Contractor's startup report
  - g. Functional test plan (FTP) and reports
  - h. Controls programming, loop tuning, sequence of operation, calibration review and comments
  - i. Integrated performance test (IPT) plan and report
  - j. TAB contractor's report
  - k. Product information (PI) report forms
  - l. Performance verification report
  - m. Outstanding commissioning issues and action log
  - n. System test summary reports
  - o. Calibration certificates of instruments used
5. **Review Comments:** Review comments including the CxA review comments and back-checks for the following at each official review stage:
- a. URS
  - b. BOD
  - c. Design drawings
  - d. Design specifications
  - e. Construction submittal review comments
  - f. Record drawings

- g. Record specifications
6. **Standard Operating Procedures (SOP) Manual:** This shall include a description of each system together with a description of all operating modes. It will be produced by the A/E during the design phase and revised/updated through the end of the Cx execution.
  7. **Operating and Maintenance (O&M) Manual:** Produced by the construction contractor during the construction phase. This document should be 90% complete prior to startup testing and inspections. During the Cx execution, all missing/remaining data will be added. This manual shall be organized so that keeping it up-to-date will require minimum time and resources (After the project, this document will be “owned” and maintained by ORF/DFOM, for the life cycle of the facility).
  8. **Factory Acceptance Test Report (FAT):** Performance verification tests and inspections conducted at the factory. These shall be witnessed and certified by the CxA and shall include the fully executed Pre-Delivery Inspection Plan.
  9. **Site Acceptance Test Report (SAT):** Performance verification tests and inspections conducted at the factory shall be witnessed and certified by the CxA.
  10. **Warranties:** The Contractor shall provide a complete inventory to the designer who will review before submission to the CxA for additional review.
  11. **Service Contracts:** Although service contracts are not part of commissioning, the A/E will assist the CxA in developing a complete description of all items included in the service contract(s).
  12. **Facility Training Plan:** This will be developed during the design phase by the A/E, contractor, and led by the CxA, to meet project-specific requirements. The training plan will detail the following:
    - a. Training Schedule: Number, duration and frequency of training sessions
    - b. Identify Instructors and Trainers: This may include the A/E, construction contractor, factory-trained and certified equipment suppliers and manufacturers, factory-trained and certified maintenance specialist personnel and/or service contractors holding service contracts.
    - c. Standards of Training: Demonstration of content mastery requirements, and recommended frequency of refresher training, etc.
    - d. Training Materials: This includes specifications for training resources and collateral (handouts, etc.)
    - e. Demonstration Requirements: Whether, and to what extent the equipment being trained can/should/must be trained with hands-on, by the instructor hands-on, or by recorded document.
    - f. Manufacturers' Video-based Training: Standards for review, inclusion, and maximum periodicity of refreshment.
    - g. Video Recording of Training: Hands-on and classroom training sessions will be videotaped for future reference and retraining. Recordings shall be produced only after all systems have been fully commissioned. Production should be professional quality (well lit, clear audio overdubbing, post-production editing, and graphics, etc.). The video shall be organized into several short modules to permit the incorporation of changes during operation.
  13. **Inventory of Spare Parts, Special Tools, and Maintenance Materials:** Critical inventory will be identified during the design stage by the A/E with input from the construction contractor, CxA, and DFOM. It will be based on consideration of the complexity of the project and criticality of immediate availability as specified by the A/E.
  14. **Cx Activities During Warranty Period:** All planned commissioning activities must be completed before the issuance of the final qualification/validation report. It is typical for



certain commissioning activities to be planned for execution during the warranty period, including:

- a. Fine tuning of environmental control systems
  - b. Seasonal recommissioning
  - c. Continuous commissioning
15. **Commissioning Deliverables:** The Cx shall provide the required documents per the project-specific CMP. Generally, the schedule of Cx deliverables includes:
- a. **Schematic Design Phase:** Preliminary CMP; initial review comments of the URS, BOD, design drawings and specifications.
  - b. **Design Development Phase:** Updated CMP; Updated review comments of the URS, BOD, design drawings and specifications; preliminary SOP manual; preliminary FAT/SAT plan; preliminary training plan; preliminary warranty phase Cx activity plan.
  - c. **Construction Document Phase:** Updated CMP; updated review comments of the URS, BOD, design drawings and specifications; updated SOP manual; updated FAT/SAT plan; updated training plan; preliminary inventory of spare parts report; updated warranty phase Cx activity plan.
  - d. **Construction Phase:** Updated CMP; final review comments of the URS, BOD, design drawings and specifications; updated SOP manual; final FAT/SAT plan; updated training plan; preliminary TAB report; updated inventory of spare parts report; updated warranty phase Cx activity plan.
  - e. **Project Closeout and Facility Handover Phase:** Fully executed CMP; final review comments of the construction submittals; final TAB report; final warranty report; final service contract report; final inventory of spare parts report; final SOP manual; final training plan; updated warranty phase Cx activity plan.
  - f. **Operations and Maintenance:** Warranty

phase Cx report; updated URS.

---

## 13.16.4 Qualification Plan (QP)

This section describes the qualification of an APF project at NIH. Qualification is a quality-oriented process for verifying and documenting that the design, installation, testing, operation and performance of the facility conforms to the acceptance criteria as specified in the URS, BOD, drawings and specifications. Qualification planning is a sub-part of the PVMP. The following are generally required components of the Qualification Plan, but may vary depending on the project:

1. **Qualification Rationale:** Provides an outline of the approach to be taken in assessing the qualification efforts; determining the extent and boundary limits of the qualification effort; and executing and assigning responsibility for the projects qualification activities.
2. **Selection Criteria:** The first step is determining what equipment and utility systems will undergo qualification. This includes considerations such as product-contacting surfaces, critical/non-critical instrumentation, direct and indirect impact systems, reviewing policies, regulatory references, and published guidelines. In general, all “direct impact” systems are subject to qualifications. “Direct impact” systems are those systems that are expected to have an impact on product quality, such as, temperature, humidity, differential pressure, HEPA filters, etc. Direct impact systems may also be referred to as “qualified” systems.
3. **Listing of Equipment, Controls and Systems:** The listing of the equipment, controls, and systems shall serve as the basis from which resource requirements can be assessed.
4. **Sequence of Testing:** Once the equipment list and the system level impact assessment are completed, a detailed schedule shall be established. An analysis to determine the optimum sequence of testing from a system-to-system perspective shall be completed, and interdependencies between systems and their support

utilities determined. The sequence of testing in APF should integrate qualification activity with the overall construction, commissioning, controls and startup schedule, so that maximum leverage can be accrued to minimize duplication of effort and time.

**A. Qualification Protocol (QP):** The Qualification Protocol (QP) is an individual detailed document that describes each system under consideration, testing plans and protocols, acceptance criteria and the test results that ensure that a system is installed and operated in accordance with predetermined specifications. Much of this material will usually be developed for commissioning. The Qualification Protocol should include those activities that are critical in nature and can affect the operation, equipment and operator safety, processing parameters, and quality attributes of the product. A "direct impact" system requires a Qualification Protocol.

Execute the construction phase activities of the Qualification Protocol. See [Section 13.16.4](#).

Some of the items that a protocol may include are:

1. **System Description:** This is a general description of the system, describing its components, its designed unit operation functional capabilities, critical functions, and the boundaries of the system(s) covered under the protocol.
2. **Documentation Deliverables:** This is a list of the supporting documentation that should be received as part of the completed qualification package. It may include drawings (e.g., P&ID, record drawings, wiring diagrams, etc.), manuals, preventative maintenance procedures, reports, calibration records, turnover documents, supplier test packages, etc.
3. **Testing Requirements:** This is a description of the testing requirements and challenges, testing sequence, and testing methodology. This may include items such as records and verification of the installation process, verification of installation and operational function procedures and records, instrument testing and calibration records, pre-requisite commissioning requirements, etc.
4. **Forms for Documenting Results:** The protocol

should contain the format in which to collect and record pertinent data. Raw data may be captured within the protocol itself, or verification can be made within the protocol that relevant testing has been completed, results documented, analyzed and accepted outside of the immediate protocol as meeting specified requirements. The format for collection or verification of testing data should allow for space to provide identification and execution date of the responsible party at inspection verification points throughout the protocol.

5. **Deviations:** Pertinent deviations that occurred during the qualification phase of a project should be addressed in the protocols, with corrective actions and results described. A deviation/exceptions handling procedure should be established.
6. **Acceptance Criteria:** The expected result for each of the specified tests should be described. This should include enough detail information so an evaluation of pass or fail can be conducted.

**B. Design Qualification (DQ):** Is the process of reviewing and documenting approval of the design for compliance with GxP (i.e., USP, GMP, etc.) regulations. This process may be integrated into the design review process, at the approval of NIH.

**C. Installation Qualification (IQ):** Ensures that the critical system or equipment and its components are installed as designed, specified and to the original manufacturer's recommendations and requirements. Calibration of sensors, equipment, and/or utilities shall be performed during the execution of the IQ protocol. IQ protocols are site and project specific, and may include, but are not limited to the verification of:

1. Components installed in the correct location and that location affords all of the safety and maintenance clearances as required
2. Utility connections
3. Environmental and operating conditions
4. Unpacking and checking for damage
5. Materials of construction

6. Installer qualifications (e.g. welding)
7. Tools, supplies, and methods associated with installation (e.g. purge gas purity, fabrication locations)
8. Equipment and instrument calibration documentation
9. Chain-of custody documentation
10. Cross-checking contents against the packing list
11. Documentation of instrumentation
12. Installation ancillary instruments and options
13. Function of room alarms, indicator lamps, and interlocks
14. Function of communication
15. Calibration of sensors, equipment, and/or utilities
16. P&ID loop verification
17. BAS and EMS parameters (alert and alarm set points)
18. Verifying HEPA filters installation
19. Door gaskets and seals in classified spaces
20. Architectural finishes in classified spaces
21. Sealing in classified spaces
22. Installation
23. Calibration
24. Sequence of operations
25. Loop checks
26. Interlock functions, overrides and red/green indicator lamps

Additional IQ tasks include:

1. Tagging with IQ stickers
2. Recording calibration and validation dates of equipment used for IQ

3. Gathering all manuals
4. Verifying spare parts list and inventory
5. Site acceptance tests (SATs)
6. CO<sub>2</sub>, compressed gas, and LN<sub>2</sub> systems
7. High purity water systems if applicable

By the end of construction phase activities, the IQ should be complete. See [Section 13.16.4](#).

1. Verify installation
2. Verify calibration
3. Verify sequence of operations
4. Verify loop checks
5. Verify function of interlocks, overrides and red/green indicator lamps

**D. Operational Qualification (OQ):** Tests are performed on critical systems, equipment components and "Direct Impact" systems to ensure they are capable of operating within established limits and tolerances, such as temperature, pressure, flow, etc. All test data and measurements shall be documented as a system baseline. The main purpose of OQ is to identify and inspect features of the equipment and plumbing that can influence final product quality, such as:

1. Testing HVAC system operation against specified functional requirements
  - a. Critical operating parameters defined on the URS
  - b. Equipment operates correctly through all anticipated operating ranges
  - c. Sequence testing
  - d. Power failure testing
  - e. Challenge functions while under load comparable to routine production
  - f. Pressure differential controls and fluctuations
  - g. Temperature uniformity and control

- h. Relative humidity uniformity and control
  - i. CO<sub>2</sub>, compressed gas, and LN<sub>2</sub> controlling systems
  - j. High purity water and clean steam systems if applicable
  - k. Humidity and temperature measuring
  - l. Fan and fan-speed controllers
  - m. Emergency power and emergency power testing/transfer ride-through and/or recovery
  - n. Measurements of contamination control system recovery
  - o. HEPA filter integrity tests
2. Airflow visualization
  3. Illumination levels
  4. Sound pressure levels
  5. Door interlocks, delays, and alarms
  6. SOPs

By the end of construction phase activities, the OQ should be underway.

1. Verify completion of facility training
2. Document HEPA installation and integrity tests
3. Verify completion of as-balanced airflow diagram
4. Qualify BAS alarms, warnings, and recorders
5. Qualify airflow and pressure tests
6. Qualify air change rates
7. Verify qualification of ISO classifications (room integrity test)
8. Verify documentation of general airflow patterns (AVS)
9. Verify facility temperature uniformity mapping

**E. Performance Qualification (PQ):** PQ is conducted to demonstrate and document that the systems and

equipment produce product or materials conforming to all predetermined specifications and Critical Quality Attributes (CQAs) while operating within normal expected ranges.

By the end of construction phase activities, the facility PQ activities (if any) should be written, reviewed and approved.

PQ typically involves sampling plans and collection of sample data over a defined period. PQ protocols will describe the necessary steps to test the performance characteristics of the equipment and/or system to ensure conformance with the appropriate user requirements, monographs, or quality standards that are required to assure conformance to product quality attributes and critical process parameters. PQ elements are typically specific to a type of equipment or system. A PQ typically tests the output from a piece of equipment or system as a whole, with respect to specifications, requirements, and/or monographs. PQ testing will follow specific procedures, as applicable.

1. **Cleaning Validation (CV):** Cleaning Validation documents evidence that a cleaning and disinfection process consistently and effectively reduces potential product and/or cleaning agent residues to pre-determined acceptable limits.
2. **EMS Computer System Validation:** This section addresses the Programmable Logic Controller (PLC) or a Distributed Control System (DCS) and Computer Validation criteria including secure audit trails, authority checks, etc. The COR should consider ICH-Q7, 5.4 as a basis for this activity.
3. **List of Required Protocols and Procedures:** This includes all the equipment and utility systems, and the required protocols and procedures associated with each. This list defines the validation requirements for the project.
4. **List of Required Standard Operating Procedures (SOPs):** The list of SOPs should include the installed equipment and utility systems and the required SOP associated with each. This will help identify the level of SOP generation necessary to complete qualification/validation activities. These will generally take the form of Operation, Maintenance, and

Cleaning SOPs.

5. **Equipment and Utility System Descriptions:** These descriptions provide an overview of each system aligned with the basis of design documentation. A listing of proposed qualification tests (IQ/OQ/PQ) should be identified with a brief description of the procedure and how the associated acceptance criteria will be determined.
6. **Equipment and System Qualification:** Each piece of equipment or systems must be qualified to operate within the facility. The goal of qualification is to produce consistent, conforming products without compromise. A qualification plan should be drafted and executed by qualified personnel to satisfy the guidelines. The qualification plan generally consists of IQ and OQ sections. Major equipment changes after the initial qualification will result in the need for subsequent requalification.

**F. Documentation:** The PVMP provides the documentation requirements for the project including relevant SOPs, calibration records and procedure, qualification and validation protocols (IQ/OQ/PQ, automation, cleaning, analytical methods, process, etc.), Vendor/contract engineering support documents, training and certification records, and change control.

---

### 13.16.5 Integrated Commissioning, Qualification and Validation (CQV) Services

Integrated CQV is an option for the delivery of Cx and Vx services from a unified contract. If the project intends to pursue a CQV strategy, it must be reflected in the PEP. Individuals or firms that provide CQV services shall meet the requirements of both a CxA and VxA, as outlined in [Section 13.16](#).

The CQV effort will be led by the CQV Project Manager (PM). The CQV PM will be a part of the IPT from

conceptual design through the validation phase of the project to effectively communicate the CQV requirements throughout all phases of the project to ensure success. The CQV PM will focus on integrating all CQV activities and deliverables into each phase to minimize redundant activities, as specified in their SOW. Roles and responsibilities assigned to the CQV may include, but are not limited to:

1. Provide input into the engineering, construction, and CQV scope of work documents
2. Gain an understanding the manufacturing and the GxP basis of the project to incorporate the applicable regulatory requirements, and critical aspects of the process into the overall CQV strategy
3. Participate in the GMP design reviews
4. Develop the roles and responsibilities for the CQV activities and deliverables
5. Review and provide input into the development of the URS
6. Define system boundaries
7. Performing quality risk assessments, and system level impact assessments
8. Provide direction, review, and input into the development of the commissioning and validation master plans
9. Work with the IPT to set up the project document control and management process to ensure an efficient and effective turnover of critical documents
10. Work with the project scheduler to ensure CQV activities are integrated throughout the schedule by setting up proper tasks, durations, predecessors, successors, and resources
11. Facilitate the component criticality assessments on Direct Impact Systems
12. Review and provide input into the equipment specifications, vendor document requirements, construction quality plan, design qualification,

change management, construction startup integration plan, and the develop of factory acceptance testing where applicable

13. Provide direction, review, and input into the development of the CQV protocols
14. Conduct good documentation practice (GDP) Training to all contractors involved with the CQV process
15. Audit the Construction QA/QC inspection process
16. Review FAT and SAT documentation for pre- and post-approval.
17. Audit the “as-built” development process and
18. Audit the project document control and Management process
19. Review and provide input into the development and execution of; commissioning test plans, installation/operation qualification protocols, and performance qualification protocols
20. Provide input into exceptions and deviations throughout the CQV process.
21. Audits document turnover process
22. Verify all project turnover documents have been received and located in a secure storage location

The roles and responsibilities, listed above, are not intended to be materially different from the un-integrated performance of a CxA and VxA.



# Section 13.17

## APF Certification Requirements

---

### Contents

- |   |  |
|---|--|
| 13.17.0 Introduction                      | 13.17.6 Cleaning Integrity Test (CIT)                              |
| 13.17.1 Airborne Particle Test (APT)      | 13.17.7 Sound Pressure Test (SPT)                                  |
| 13.17.2 Airflow Visualization Study (AVS) | 13.17.8 Airflow Test (AFT)   |
| 13.17.3 HEPA Filter Integrity Test (FIT)  | 13.17.9 Airflow Pressure Differential Test (APD)                   |
| 13.17.4 Temperature Uniformity Test (TUT) | 13.17.10 Environmental Monitoring (EM)                             |
| 13.17.5 Lighting Uniformity Test (LUT)    | 13.17.11 Environmental Monitoring Performance Qualification (EMPQ) |

## 13.17.0 Introduction

The intent of APF facility certification is to ensure protection of patients, products, and workers. Failure of the modes and systems certified under this section could directly lead to the adulteration of product, placing patients at risk for injury or death. Likewise, failure of the modes and systems certified under this section could directly lead to unintended worker contact with potentially hazardous materials. The following subsections describe general guidelines for APF certification requirements, however the type, number, periodicity, and other details are highly subject to the regulatory environment, products and processes at each individual APF.

All SOP/Protocols covered in this section shall be submitted to NIH for review and approval prior to performance. Each APF should develop and maintain a Project Validation Master Plan (PVMP), which would cover the following plus additional site-specific certifications and tests. See [Section 13.16.1](#) for guidance on PVMP.

All instruments used in certification shall have valid calibration certificates based on frequency and method of calibration per ISO 21501-4.

Validated cleanrooms shall be validated to a required class of cleanliness, defined in ISO1464-1. Acceptable methods for evaluation and measurements for Certification are specified in ISO14644-3, which specifies the following required and optional tests, as listed in [Table 13.17.0](#), which are required of NIH APFs.

Once certified to a particular class the cleanroom factors, APF cleanrooms shall be monitored to ensure that parameters have not drifted, or changed, and that the environment is under control.

---

### 13.17.1 Airborne Particle Test (APT)

APFs shall be tested for airborne particle counts as an indication that work processes, cleaning and HVAC are working as intended. An APT captures a snapshot of the cleanliness of the air in a particular moment. As a snapshot, values under this test may be anticipated to have considerable fluctuations, yet should remain below

specified threshold values.

These particles are measured using a discrete particle counter (different from a photometer that is used to test installed filter leaks) that is used to count number and size of particles.

An APT should be performed:

1. An APT is required when bringing a new facility online.
2. At a frequency sufficient to produce meaningful and actionable trends, and the soonest of:
  - a. The time interval as specified in ISO 14644-2
  - b. In APF areas ISO 5 or cleaner, the maximum periodicity for re-qualification shall be not more than 6 months.
  - c. In APF areas less ISO 6 or less clean, the maximum periodicity for re-qualification shall be not more than 12 months.
  - d. As determined by the APF QA to adequately demonstrate the facility is operating in a state of control
3. The APF User QA shall develop an APT plan to establish minimum sampling criteria, including number of sampling locations, volumes and periodicity of sampling. A formal risk assessment is a requirement for a compliant APT plan.
  - a. The APT plan shall be based on statistical criteria proscribed in ISO 14644. Each APF may choose to establish maximum concentration limits that are more restrictive than these minima for a given particle size (i.e. 0.1  $\mu\text{m}$  - 5.0  $\mu\text{m}$ ).
  - b. Sampling should be toward likely problem spots, such as near entrances and workstations.
  - c. The APT plan shall specify static, dynamic or both conditions to be sampled.
  - d. Periodicity of monitoring may be continuous, sequential, or periodic.

**Table 13.17.0 NIH APF Cleanroom and Associated Controlled Environments Test Methods**

ISO 14644 Required	NIH APF Required		Test	Reference in ISO 14644-3			Referenced In
	Biologics Facilities	Pharmacy Facilities		Principle	Procedure	Apparatus	
•	•	•	Airborne Particle Count for Classification and Test Measurement of Cleanrooms and Clean Air Devices	4.2.1	B.1	C.1	ISO 14644-1, ISO 14644-2, and DRM Section 13.17.1
◆	◆	◆	Airborne Particle Count for Ultrafine Particles Test	4.2.1	B.2	C.2	ISO 14644-1 and DRM Section 13.17.1
◆	◆	◆	Airborne Particle Count for Macro-Particles Test	4.2.1	B.3	C.3	ISO 14644-1 and DRM Section 13.17.1
•	•	•	Airflow Tests	4.2.2	B.4	C.4	ISO 14644-1, ISO 14644-2, and DRM Section 13.17.2
•	•	•	Air Pressure Differential Test	4.2.3	B.5	C.5	ISO 14644-1, ISO 14644-2
◆	•	•	Installed Filter System Leakage Test	4.2.4	B.6	C.6	ISO 14644-2 and DRM Section 13.17.3
◆	•	•	Airflow Direction Test and Visualization	4.2.5	B.7	C.7	ISO 14644-2 and DRM Section 13.17.2
◆	◆	•	Temperature Test	4.2.6	B.8	C.8	ISO 7726 and DRM Section 13.17.4
◆	◆	◆	Humidity Test	4.2.6	B.9	C.9	ISO 7726
◆		◆	Electrostatic and Ion Generator Tests	4.2.7	B.10	C.10	
◆	◆	◆	Particle Deposition Test	4.2.8	B.11	C.11	
◆	•	•	Recovery Test	4.2.9	B.12	C.12	ISO 14644-2
◆	◆	•	Containment Leak Test	4.2.10	B.13	C.13	ISO 14644-1 and ISO 14644-2
	•	•	Lighting Uniformity Test (LUT)				DRM Section 13.17.5
	•	•	Cleaning Integrity Test (CIT)				DRM Section 13.17.6
	◆	◆	Sound Pressure Test (SPT)				DRM Section 13.17.7
•	•	•	EMPQ				DRM Section 13.17.11

• *Required Test*

◆ *Optional Test*

The tests listed may not be all-inclusive, nor may these be all of the tests required for a given APF certification. Tests and methods should be selected in a manner agreed to by the User QA group, and the IPT, with the QA having final approval. Selected tests may be repeated with a scheduled periodicity as part of a routine facility monitoring program per ISO 14644-2. Specific test protocols should be developed for each facility, including test sequence per ISO 14644-3 Annex A.

- e. Meet or exceed the requirements of ISO 14644-3.4.1.
  - f. Define instrument calibration (per ISO21501-4) and technician training requirements.
4. Shall define acceptance criteria.
  5. Specify adverse result actions.

## References:

1. ISO 14644 – Parts 1-6: Cleanrooms and Associated Controlled Environments, and Annex-A
2. ISO21501-4: Determination of particle size distribution -- Single particle light interaction methods -- Part 4: Light scattering airborne particle counter for clean spaces

## 13.17.2 Airflow Visualization Study (AVS)

Airflow Visualization Studies (AVS, sometimes referred to as “smoke studies”) are a critical activity in the qualification, operation, and monitoring of APFs. AVS are conducted to confirm unidirectional airflow by providing visual documentation of conformance to regulatory requirements and intent. An AVS should be performed:

1. A full AVS is required when bringing a new facility online.
2. A localized (i.e., suite or room level) AVS shall be performed when large equipment is relocated, any time a PEC, or supply/return/exhaust device is added, removed, or significantly altered.
3. A targeted (or full) AVS should be performed when supply, exhaust, differential pressure set points are changed. All spaces that are impacted by the pressure cascade should be re-tested (i.e., targeted).
4. A full AVS should be re-performed at a periodicity, typically not more than every 2 years, set forth in an AVS SOP.

AVS SOPs/Protocols shall:

1. Proscribe the specific methods, techniques and materials acceptable for AVS, including the use of a cleanroom; the time to open, hold, close and recover at doors; etc.
  - a. Acceptable: WFI grade water or Food Grade Propylene Glycol
  - b. Less Acceptable: CO<sub>2</sub> and N<sub>2</sub>
  - c. Unacceptable: Glycerin Bubbles, Smoke Candles, (ZnCl<sub>2</sub> or Zn Stearate), or Titanium Smoke
2. Describe the performance of static and dynamic conditions, as applicable.
3. Describe the airflow characteristics throughout the APF.
4. Specify AVS test acceptance criteria. These criteria should include site-specific criteria and the following general requirements:
  - a. Airflow shall move toward potential sources of contamination and away from areas of higher product risk.
  - b. Airflow shall flow smoothly in one direction with no turbulence or eddies, in a downward sweeping pattern, without stagnation.
  - c. Airflow, when disrupted, shall recover quickly and reestablish unidirectional flow.
  - d. Define acceptance criteria.
  - e. Airflow pattern analyses shall evaluate both static and dynamic conditions to determine that personnel activities do not negatively affect airflow patterns in critical areas (e.g., ISO 5 PECs, air movement and cascade in transitions between differing ISO classified areas, etc.).
5. Describe AVS report criteria.
6. Discuss photography and videography issues, such as reflections, lighting, shadows, white balance and other techniques that have a direct impact on the quality and utility of the

end-product.

7. Address video post-production requirements, including superimposed text, voiceovers, and related issues.
8. Include specifications on documentation standards, including sections for written results, discussion, and conclusion.

#### References:

1. ISO 14644 – Parts 1-6: Cleanrooms and Associated Controlled Environments
2. IEST-RP-CC002.3: Unidirectional-Flow, Clean-Air Devices
3. IEST-RP-CC006.3: Testing Cleanrooms

### 13.17.3 HEPA Filter Integrity Test (FIT)

The cleanliness of the air, and the ability of the primary and secondary engineering controls to resist adulteration of the product, and to mitigate patient and worker risk are highly reliant on HEPA filtration. Regular maintenance and operation of the APF reflects the need to have a high confidence of the acceptable status of these filters and their seals. A FIT should be performed:

1. Whenever HEPA filters are decontaminated, qualified, or requalified.
2. At the discretion of NIH.
3. At a periodicity, typically not more than every 1 year, set forth in the SOP.

#### FIT SOPs/Protocols shall:

1. Integrity test 100% of filters
2. Validate filters as an assembly (integrity test certified) for efficiency and leak integrity by the manufacturer and shall be validated again in situ.
3. Require forwarded certification of tests and procedures to DOHS and ORF for approval.

4. Document the values for integrity testing/validation in the SOPs, and as approved by DOHS.
5. Define the testing agent and procedures.
6. Define allowable repair materials and methods.
7. Define acceptance criteria.

#### References:

1. IEST RP-CC001 HEPA and ULPA Filters
2. IEST RP-CC034.2 HEPA and ULPA Filter Leak Test
3. ISO 14644 – Parts 1-6: Cleanrooms and Associated Controlled Environments
4. [Section 8.6.12.1 HEPA Filters/In-Line Filters](#)

### 13.17.4 Temperature Uniformity Test (TUT)

Temperature poses a risk to product quality during production and storage of products and raw materials. A TUT may be performed within a single piece of equipment or within the whole space. This section only refers to the room/facility. A TUT should be performed:

1. At a frequency sufficient to demonstrate the facility is under control as established in the SOP.
2. Frequently enough to produce meaningful and actionable trends.
3. When heat-generating equipment is added or removed, or any large equipment is moved within the space.

#### TUT SOP/Protocol shall:

1. Describe the specific monitoring plan for TUT at the APF.
2. Map all sensor locations, for BAS, EMS and temperature mapping.
  - a. A TUT test deploys multiple, independent, calibrated sensors arrayed about a space to create a 3-dimensional temperature map of

a given space

- b. The validated EMS system probes should be the reference point for all TUT studies for regulatory compliance purposes.
3. Specify acceptable ranges.
4. Identify areas at risk, and sampling should skew toward likely problem spots, such as near entrances and workstations.
5. Define TUT test duration and periodicity of retesting.
6. Define calibration requirements.

#### References:

1. USP Chapter 1079 Monitoring Devices – Good Storage and Shipping Practices
2. USP Chapter 1118 Monitoring Devices – Time, Temperature, and Humidity
3. 21 CFR Part 211 cGMP for Finished Pharmaceuticals
4. FDA Guidance for Industry: Quality Systems Approach to Pharmaceutical cGMP Regulations (2006)
5. FDA Pharmaceutical cGMPs for the 21st Century – A Risk-Based Approach (2004)
6. ISO/IEC 17025:2005 General Requirements for the Competence of Testing and Calibration Laboratories
7. ISO 10012:2003 Measurement Management Systems

---

## 13.17.5 Lighting Uniformity Test (LUT)

Lighting properties are an essential component of the visual inspection process. The visually demanding tasks at the laboratory bench require illumination and must be provided at adequate and uniform levels from low-glare; ceiling reflection, and shadow-free lighting systems. These factors combine to impact productivity and

accuracy, based on expectations, motivation, and cost.

A LUT should be performed:

1. At facility validation
2. At a periodicity, typically not more than every 2 years, set forth in an LUT SOP to account for output fall-off of LEDs and other lamp-types.

A LUT SOP/Protocol shall:

1. Define the illumination intensity required for the various areas within the APF, per IESNA and EN12464-1.
2. Require certification of tests and procedures shall be forwarded to DOHS and ORF for approval.
3. Document the values for integrity testing/validation in the SOPs, and as approved by DOHS.
4. Define the testing procedures.
5. Define acceptance criteria.

#### References:

1. ISO 14644 – Parts 1-6: Cleanrooms and Associated Controlled Environments
2. Illuminating Engineering Society Handbook
3. RP-29 Lighting for Hospitals and Health Care Facilities

---

## 13.17.6 Cleaning Integrity Test (CIT)

Cleaning integrity testing is the initial and ongoing qualification of the cleaning materials and methods to achieve the desired efficacy of the cleaning program as required and the risks associated with the product(s) being produced at the APF. The cleaning program must reduce the bioburden present in the facility and achieve the necessary level of microbial reduction. This is achieved through the application of appropriate chemical agents, for a requisite length of time, then neutralized or removed, with sufficient residual antimicrobial action to suppress growth until the next scheduled



cleaning, without degradation of the finishes.

The efficacy of this program must be regularly surveilled and tested, informing the process of whether changes such as longer/shorter contact time, a change in rotation of agents, or lapses in application technique need to be addressed.

The final description and implementation of the CIT is the responsibility of the individual APF, however a general awareness of the program and the preparation of representative coupons, as described, below, falls to the design and construction team.

**A. Disinfection vs Sanitization:** The key difference between these terms is whether the agent will “reduce” or “Kill” the microbial growth it is applied to. In different areas of the APF, the goal may be one or the other. Successive application of agents may have the goal to sanitize, and on the successive application of material, to disinfect.

The surface test described below cannot fully demonstrate the effect of environmental factors like temperature, pH, detergent residues, mechanical stress, and attachment in the facility. For these reasons, a disinfectant which appears effective for the coupon test can have significant variability when applied more broadly in the APF. Field trials (or in situ studies) are an important part of the qualification of the Cleaning Integrity Test (CIT). These trials determine if cleaning materials and methods are suitable or require modification.

**B. Addressing Sanitization/Disinfection Effectiveness:** Effectiveness of sanitization/disinfection is assessed through environmental monitoring (EM). Viable monitoring of surfaces is the most relevant approach for assessing the effectiveness of surface sanitization, although air sampling is also performed. To demonstrate the efficacy of a sanitization/disinfectant protocol (material and method) within the APF environment, the following tests should be performed:

1. **Use-Dilution Test:** Use-Dilution Testing assesses disinfectants for efficacy at various concentrations and contact times against a wide range of standard test organisms.
2. **Surface Challenge Test:** Representative manufacturing surface samples (coupons) are inoculated with a selection of microbial challenge organisms (organisms of concern, and typical

local isolates). A disinfectant is applied to the inoculated surfaces and exposed for a predetermined contact time after which surviving organisms are recovered using a qualified disinfectant-neutralizing broth and test method (surface rinse, contact plate, or swab). The number of challenge organisms recovered from the test samples (exposed to a disinfectant) is compared to the number of challenge organisms recovered from the corresponding control sample (not exposed to a disinfectant) to determine the ability of the disinfectant to reduce the microbial bioburden. Successful completion of the validation qualifies the disinfectant evaluated for use. The disinfectant efficacy validation shall document that the disinfectant demonstrated bactericidal, fungicidal, and/or sporicidal activity sufficient to control microbial contamination in the facility.

3. **Marker & Token Test:** A test where the APF quality assurance personnel strategically place marks with a permanent marker and leave small, loose, numbered, stainless steel markers about the facility which are to be collected by the cleaning crew and returned to the QA to assess whether all locations have been cleaned as required.
4. **Visual Assessment Test:** A visual assessment test is conducted by the APF quality assurance personnel, immediately subsequent to the performance of a cleaning to look for visual evidence of the insufficiency of a particular cleaning effort (i.e., dust, streaks, films, etc.)

A CIT SOP/Protocol shall:

1. APF Startup Tests should include Use-dilution Test, Surface Challenge tests, and Environmental Monitoring.
2. APF In-Operation Tests should include: Environmental Monitoring; Marker & Token Test; Visual Inspection Test.
3. Create an APF-specific environmental sampling program per GxP. Each APF may choose to exceed these minima.
4. Define the testing locations, periodicity and related procedures.

5. Specify the incubation procedures.
6. Define equipment calibration and technician training requirements
7. Refer to the acceptance criteria as defined in the EM Plan.
8. Specify adverse result actions
9. In USP <797> facilities, if any CFUs are detected on a test plate from an ISO 8 or better area, then regulation requires that the colonies growing on that plate be identified to at least the genus level, even if the number of colonies is below the recommended action level. See [Table 13.17.11](#). In all other (i.e. non-USP <797>) areas, the facility QA shall define the action limits.

A CIT shall be performed when:

1. Coupon tests are recommended, during design.
2. Mockup and/or coupon tests shall be performed during construction.
3. At any change in cleaning products or methodology and not to exceed 2 years.
4. May be required upon a surface excursion beyond 15 CFU recovered from a single ISO 5 sample, at the discretion of the APF QA

References:

1. Vina, P., Rubio, S. and Sandle, T. (2011): ‘Selection and Validation of Disinfectants’, in Saghee, M.R., Sandle, T. and Tidswell, E.C. (Eds.) (2011): *Microbiology and Sterility Assurance in Pharmaceuticals and Medical Devices*, New Delhi: Business Horizons, pp 219-236

---

### 13.17.7 Sound Pressure Test (SPT)

Sound pressure level testing should be considered for both occupant comfort and safety. Typical A-weighted sound pressure level range for cleanroom is between

55-65 dBA. NIOSH recommends limiting the 8 hour exposure to less than 85 dBA, which is more conservative than the OSHA exposure limit, and consistent with [Section 6.5.5](#). The design target for APFs shall be not more than 60 dBA, due to the scarcity of acoustical treatments available in these environments.

An SPT shall be performed:

1. During commissioning
2. After major HVAC changes during O&M

An SPT SOP/Protocol shall:

1. Define the testing locations, periodicity and related procedures
2. Define equipment calibration and technician training requirements
3. Define acceptance criteria
4. Specify adverse result actions

References:

1. ISO 3746:2010 Acoustics – Determination of sound power levels and sound energy levels of noise sources using sound pressure – Survey method using an enveloping measurement surface over a reflecting plane
2. ANSI Standard S12.12-1992 (R2012), *Engineering Method for the Determination of Sound Power Levels of Noise Sources Using Sound Intensity*, 2012
3. Air Conditioning, Heating & Refrigeration Institute (AHRI) *Sound Intensity Testing Procedures for Determining Sound Power of HVAC Equipment*, 2013

---

### 13.17.8 Airflow Test (AFT)

APFs shall be tested for airflow as an indication that airflow supply airflow volume, velocity distribution, and uniformity meet the design intent and conform to applicable regulations. An AFT captures data from multiple occupancy states and is generally indicative of the ability of the system to provide uniform airflow.

An AFT should be performed:

1. During qualification
2. After major HVAC changes during O&M
3. At a frequency sufficient to demonstrate the facility is under control
4. Frequently enough to produce meaningful and actionable trends
5. The maximum periodicity for re-qualification shall be not more than 12 months, or as determined by User QA

AFT SOPs/Protocols shall:

1. Describe the specific monitoring plan for the APF, either downstream of the final filters, or in the supply air ducts, as prescribed in ISO 14644.
2. Specify operational (dynamic) conditions, and at-rest (static) and be sampled in the monitoring plan.
3. Define equipment calibration and technician training requirements
4. Define acceptance criteria.
5. Specify adverse result actions.
6. Meet or exceed the requirements of ISO 14644-3.B.4.

References:

1. ISO 14644 – Parts 1-6: Cleanrooms and Associated Controlled Environments, and Annex-A

be performed:

1. During qualification
2. After major HVAC changes during O&M
3. At a frequency sufficient to demonstrate the facility is under control
4. Frequently enough to produce meaningful and actionable trends
5. The maximum periodicity for re-qualification shall be not more than 12 months, or as determined by user QA

APD SOPs/Protocols shall:

1. Describe the specific monitoring plan for the APF, either downstream of the final filters, or in the supply air ducts, as prescribed in ISO 14644.
2. Specify operational (dynamic) conditions, and at-rest (static) and be sampled in the monitoring plan.
3. Define equipment calibration and technician training requirements.
4. Define acceptance criteria.
5. Specify adverse result actions.
6. Meet or exceed the requirements of ISO 14644-3.B.5.

References:

1. ISO 14644 – Parts 1-6: Cleanrooms and Associated Controlled Environments, and Annex-A

---

### 13.17.9 Airflow Pressure Differential Test (APD)

APFs shall be tested to verify the capability of the facility to maintain specified pressure differentials, both internally, and to the surrounding environment. An APD captures data from multiple occupancy states and is generally indicative of the ability of the system to provide the designed pressure differentials. An APD should

---

### 13.17.10 Environmental Monitoring (EM)

Environmental Monitoring (EM) is the overall program for the monitoring of the levels and sources or potential contamination within an APF. The EM program is a risk-based, ongoing assessment of the conditions measured/surveyed/sampled within the APF, and the efficacy of local controls, both process and engineering,

to deter microbial ingress, microbial proliferation, and the overall presence of particles (both non-viable and viable). The EM program is a function of the user's QA. The EM program is inclusive of raw materials, product, process, equipment, and facility, but for the purposes of this section, the focus will be on the latter.

The EM Plan shall define:

1. The Risk Management Team, headed by QA, to include APF manufacturing, CC/DLM, DFOM, and FCIS, and/or others based on APF-specific requirements. Team must be cross-functional.
  - a. Define scope of activity
  - b. Determine risk management tools to be used
    - i. Hazard Analysis and Critical Control Point (HACCP)
    - ii. Failure Mode and Effect Analysis (FMEA)
    - iii. Failure Mode and Effect and Criticality Analysis (FMECA)
    - iv. Risk Management of Contamination (RMC)
  - c. Determine evaluation protocol (Prioritization)
  - d. Define communication plan
  - e. Define periodicity of assessment/re-assessment of controls, risks, etc.
  - f. Define controls requirements, both engineering and administrative
  - g. Evaluation of regulatory and internal audit findings
2. The acceptance criteria for non-viable and viable particles (Alert and Alarm levels) for facilities as-built, at-rest/static, and operational/dynamic:
  - a. **Non-Viable Particles:** ISO 14644-1, USP <1116> and the European Commission Annex-I all address the limits for total (specifically inclusive of non-viable particles)

somewhat differently. A non-viable particle (such as a dust mote, etc.) is a particle that does not contain or have adsorbed to it, a living microorganism, rather it acts as transportation for viable particles. These types of particles are frequently produced by construction and maintenance activities. Non-viable particles are monitored using particle counters that do not distinguish between viable and non-viable, reading out only total particles per cubic meter. Supporting data can be leveraged from the APT.

- b. **Viable Particles:** ISO 14698 establishes a formal system for monitoring and applying control measures against the risks of bio-contamination (i.e. viable particles). Any required harmonization must be performed by the APF QA and well documented. A viable particle contains a living microorganism (bacteria, mold, spore, fungi, yeast, etc.). Viable particles typically enter APFs on personnel, materials and tools, but also may enter through leakage, HVAC/Control system failures which lead to undesirable pressure conditions, etc. Early detection and mitigation is crucial for the prevention of product contamination. Viable particles may be detected by some counters, such as those using Laser Induced Fluorescence, but such counters are not in common use at NIH. In lieu, various agar plates are collected, using swab, touch, and impacted air methods, then incubated. This allows for colony forming unit (CFU) counts and speciation of any observed growth, which can help identify potential sources of contamination/growth in the facility. These viable/non-viable particle counts and the incubation and speciation of viable particles are managed by the APF staff, and adverse results are shared with ORF to assist in planning and executing corrective actions when required.

#### References:

1. Vina, P., Rubio, S. and Sandle, T. (2011): 'Selection and Validation of Disinfectants',

in Saghee, M.R., Sandle, T. and Tidswell, E.C. (Eds.) (2011): Microbiology and Sterility Assurance in Pharmaceuticals and Medical Devices, New Delhi: Business Horizons, pp 219-236

2. United States Pharmacopeia Convention. <797> Pharmaceutical Compounding – Sterile Preparations. Revision Bulletin
3. ISO 14644 – Parts 1-6: Cleanrooms and Associated Controlled Environments, and Annex-A
4. ISO 14698-1:2003: Cleanrooms and associated controlled environments -- Biocontamination control -- Part 1: General principles and methods
5. United States Pharmacopeia Convention. <1116> Microbiological Evaluation of Cleanrooms and Other Controlled Environments. National Formulary
6. ISO21501-4: Determination of particle size distribution -- Single particle light interaction methods -- Part 4: Light scattering airborne particle counter for clean spaces
7. PHSS Technical Monograph #20 “Bio-contamination characterization, control, monitoring and deviation management in controlled/ GMP classified areas”

---

### 13.17.11 Environmental Monitoring Performance Qualification (EMPQ)

Environmental Monitoring Performance Qualification is a user QA-managed Performance Qualification (PQ) that demonstrates control of non-viable and viable particles in critical areas, including, but not limited to the monitoring of the air, surfaces and personnel for contamination. The EMPQ is a subset of the EM Plan, which establishes the facility requirements for type, periodicity, location and methodology of the routine testing of the APF environment.

The EMPQ plan shall define the following:

1. Graphically, supported by calculation/chart, as appropriate under GxP, define the number of sample point locations for air and surface monitoring.
  - a. Locations should be risk-biased, including those in close proximity to exposed product, product contact surfaces, areas for donning/doffing of PPE, high traffic areas, etc.
  - b. Locations should include some walls and floors.
  - c. The number of sampling locations per room should be risk based, rather than simply ISO-based, while avoiding over/under sampling to the extent practicable.

2. Provide risk-based rationale for sample locations and periodicity.

3. Develop and execute protocols:

For viable testing, define:

- a. Testing and media type (active air sampling, contact plates, swabs, etc.)
- b. Incubation temperatures and durations
- c. Microbial Identification:
  - i. Which samples need to be identified
  - ii. Monitoring including classical and Rapid Micro Methods (RMM), and whether genotypic, biochemical, or phenotypic techniques are required (may be case specific)

For non-viable and total particle testing follow harmonized GxP requirements.

4. Describe the specific evaluation of the data, including:
  - a. Trend analysis of data to confirm whether the facility is under adequate control. Monitoring results alone (historical data), shall be considered insufficient if it does not support and inform a clear and approved plan.

- b. Positive characterization of organisms of concern.
  - c. Ongoing assessment of overall cleaning program efficacy and tuning of plan to address changes in facility condition.
5. Define adverse result action:
- a. If any CFU's are detected on a test plate from an ISO 8 or better area, then USP <797> requires that the colonies growing on that plate be identified to at least the genus level, even if the number of colonies is below the recommended action level. See [Table 13.17.11](#).
  - b. If excursion exceeds USP <1116> Microbiological Control and Monitoring of Aseptic Processing Environments, Table 3 for aseptic environments.
  - c. If excursion exceeds USP <1115> Bioburden Control of Nonsterile Drug Substances and Products limits for non-aseptic environments.
  - d. Provide guidance for undertaking investigations and initiating/informing Corrective And Preventative Actions (CAPAs), associated with a detected excursion.

**Table 13.17.11 Air Quality Monitoring Acceptance Derived from FDA Requirements**

ISO Class	≥ 0.5 µm Nonviable Particles / m <sup>3</sup>	Viable Airborne (CFU / m <sup>3</sup> )	Viable Surface (CFU / contact plate)
5	3,520	> 1	> 3
7	352,000	> 10	> 5
8	3,520,000	> 100	> 100

## References:

1. Vina, P., Rubio, S. and Sandle, T. (2011): 'Selection and Validation of Disinfectants', in Saghee, M.R., Sandle, T. and Tidswell, E.C. (Eds.) (2011): Microbiology and Sterility Assurance in Pharmaceuticals and Medical Devices, New Delhi: Business Horizons, pp 219-236
2. United States Pharmacopeia Convention. <797> Pharmaceutical Compounding – Sterile Preparations. Revision Bulletin
3. ISO 14644 – Parts 1-6: Cleanrooms and Associated Controlled Environments, and Annex-A
4. ISO 14698-1:2003: Cleanrooms and associated controlled environments -- Biocontamination control -- Part 1: General principles and methods
5. United States Pharmacopeia Convention. <1116> Microbiological Evaluation of Cleanrooms and Other Controlled Environments. National Formulary
6. ISO21501-4: Determination of particle size distribution -- Single particle light interaction methods -- Part 4: Light scattering airborne particle counter for clean spaces
7. PHSS Technical Monograph #20 "Bio-contamination characterization, control, monitoring and deviation management in controlled/ GMP classified areas"



# Section 13.18

## Project Closeout and Facility Handover Phase

---

### Contents

13.18.0 Introduction

13.18.1 Certificate of Use

13.18.2 Dashboards

## 13.18.0 Introduction

The activities of the project closeout and facility handover phase begin subsequent to the acceptance of the fully executed PVMP, which documents conformity to the project design documents as well as the requirements of the harmonized GxP environment, regulating the facility. These activities include the finalization of all project activities and the receipt of all project documents in final, reviewed and accepted form.

The purpose of a formalized project closeout process is to ensure that all documentation has been completed, with the required documents under document control, and all documents have been delivered to and accepted by the appropriate parties, per the PEP.

There is no “Substantial Completion” in APF projects. The “Handover” date is the point at which the construction contractor’s work is deemed complete, including:

1. Completion of all punch list items
2. The CMP has been fully executed
3. The IQ/OQ have been completed (PQ may still be underway)
4. All construction-related documentation has been reviewed and accepted (closeout)

This section does not address the administrative or contract closure requirements. These are managed by the CO and COR per the requirements of the individual contracts and options exercised under this project.

The project closeout includes documents which end at the point of acceptance; documents which persist, to be updated/maintained as current throughout the life cycle of the facility; and documents which are derived in a post-project examination process. See [Table 13.18.0](#).

**Documents which terminate at the acceptance of the APF project:**

1. Project Design Documents:
  - a. As-Designed Record Drawings: Record of everything the A/E designed for the project, the original construction documents with all addenda, A/E’s supplemental instructions, change orders, construction change directives and minor changes in the work

– shall include a full set of bound, editable CAD files and PDF files of each sheet, and may include project BIMs, as defined in the SOW.

- b. As-Constructed Record Drawings: Record of the project as constructed based on information the contractor provided to the Government under the contract for construction – typically a color scan of the contractor’s field set with all markups. May include a full set of bound, editable CAD files and PDF files of each sheet, and may include project BIMs, updated per the revisions noted on the contractor’s field set, per the SOW.

2. Fully executed PEP
3. Type-C meeting package(s)
4. BOD
5. Construction submittals
6. Fully executed FAT
7. Fully executed SAT
8. Fully executed CQP
9. Fully executed PVMP
  - a. Design Qualification (DQ)
  - b. System Level Impact Assessment (SLIA)
  - c. Commissioning Master Plan (CMP)
  - d. Qualification Plan/Protocol (QP)
  - e. Installation Qualification (IQ)
  - f. Operational Qualification (OQ)
  - g. Performance Qualification (PQ), if any apply to facilities
10. Facility SOPs

**The following documents shall be furnished to NIH and are to be maintained as current after the acceptance of the APF project:**

1. Project Documents:

- a. Documents shall include Record of the Work As Constructed drawings. Record of the Project as constructed based on information the contractor provides to the owner Government under the contract for construction coupled with re-survey by the Architect and Engineer(s) – typically a full set of editable CAD files and PDF files of each sheet.
- b. Record of the Work As Constructed specifications
- c. Record of the Work As Constructed BOD
- d. URS
- e. PVMP
- f. TAB
- g. O&M manuals

**Documents which derive from after-action analysis of the APF project:**

1. Post-Project Assessment by IPT:
  - a. Conformance to schedule/WBS
  - b. Conformance to budget
  - c. Assessment of project methodology/ approach
  - d. Assessment of project communications
  - e. Lessons Learned
  - f. Lessons Learned by Project Team; NIH-Internal Stakeholders (Users, ORSC, DTR/FCIS, CCOFM, HEFS, DFOM, etc.)
  - g. Project organization
  - h. Risk management
  - i. Recommended changes to approach to improve subsequent projects

---

## 13.18.1 Certificate of Use

APFs, upon completion, testing and acceptance shall

receive a certificate of use, issued by DTR/FCIS. This certificate designates that the facility has been inspected, documents received, and the facility is ready to begin operation. The certificate of use is re-issued annually, in conjunction with a facility re-inspection and maintenance of the facility. See [Exhibit 13.3 APF Certificate of Use Checklist](#). The certificate of use shall be based on the PEP document and shall be used to determine issuance of the certificate of use.

---

## 13.18.2 Dashboards

A dashboard for the APF is a central component for the operation and communication of advanced, resilient and regulatory compliant facility.

The dashboard shall be developed, implemented and maintained by ORF, for the entire APF portfolio. The dashboards are intended for internal use and are meant to be informative, facilitate quick inspection and preliminary inquiry only. Dashboards are not intended to replace detailed engineering analysis, or impinge on the primacy of the validated EMS for regulatory compliance purposes.

The dashboard for each facility shall report and configure BAS sensor data through a secure webpage. The dashboard shall display the floorplan (with room names and numbers) of the facility along with critical parameters of the APF as follows:

1. Design Directional Airflow
2. ISO classification of the facility rooms (i.e., NC, CNC, ISO 8, ISO 7, etc.)
3. Room Differential Pressure (dynamic image)
4. Room Temperature (dynamic image)
5. Room Humidity (dynamic image)
6. Room Air Changes Per Hour (dynamic image)
7. Indicate on a room-by-room basis the conformance/out of specification (OOS) of each room, individually, via a red/green indicator.
8. Display the current alarms and warnings.
9. Display the alerts over the past 24 hours.

**Table 13.18.0 APF Document Review and Approval (Commissioning and Validation Phase)**

Document	Signed	Controlled	PO/COR	Per DRM Section 1.5.3.3	FCIS	ORSC	DFOM	NIH Program (User)	User QA	External Regulatory Agencies
Project Execution Plan (PEP) *	•		IRS		R	R		RS	R	
Final Design Contract Documents (Dwgs., specs., etc.) *	•	•	IRS	R	RS	R	R	RS	RS	
User Requirement Specifications (URS)*	•	•	IRS	R	RS	RS		RS	RS	R
Basis Of Design (BOD) *	•	•	IRS	R	RS	RS		RS	RS	R
Project Validation Master Plan (PVMP) *			IRS	R	RS	R	R	RS	RS	
Test Protocols as applicable per DRM Section 13.17	•	•	IRS	R	RS	R	R	RS	RS	
Fully Executed Cx with Report(s)	•	•	IRS		RS	R	R	RS	RS	
Fully Executed PVMP with Report(s)	•	•	IRS		RS	R	R	RS	RS	
SAT/FAT, where applicable, fully executed with report	•	•	IRS		RS	R	R	RS	RS	
Facility and Program SOPs	•	•			IRS	R	IRS	IRS	RS	
Facility Training Plan	•	•			RS	R	IRS	R	R	

\* Updated, if required, due to unforeseen conditions

I Initiated By

R Reviewer

S Signatory

Note: Unless indicated otherwise, PO/COR is responsible for the management of the above document(s).

# Section 13.19

## Cleaning and Sanitation

---

### Contents

13.19.0 Introduction

13.19.1 Finish Selection for Cleanability

13.19.2 Facility Cleaning SOP

13.19.3 Cleaning, Sanitizing, and Disinfecting  
Chemicals

13.19.4 Cleaning Air Systems

13.19.5 Cleaning Protocols

13.19.6 Cleaner Qualifications

## 13.19.0 Introduction

One of the features which distinguish APFs from other laboratories and healthcare spaces is the development and maintenance of a robust and verified, effective cleaning procedure. These procedures must be documented, performed by trained personnel, using approved materials and methods, on both a regularly scheduled and an as-needed basis. The cleaning protocols shall be developed using scientific and technical considerations. The purpose of cleaning is to remove bioburden and to make sanitizing and disinfecting chemicals more effective. The purpose of sanitizing is to kill/inert >99.9% of bio-active particles remaining on the surface after pre-cleaning. The purpose of disinfecting is to kill/inert 100% bio-active particles on the surface (may require pre-cleaning), including 100% of vegetative bacteria, target viruses and target fungi. The purpose of sterilizing is to kill/inert 100% of the bio-active particles, including all microorganisms and spores, on the surface after pre-cleaning.

Facility cleaning is above and beyond the facility user's daily cleaning. Facility cleaning is largely a manual process and is subject to variation in effectiveness due to applicator technique, materials and adherence to the facility's cleaning SOP. These SOPs detail the requirements for the cleaning and maintaining of scientific equipment, which may employ some combination of automated Clean-In-Place (CIP) cleaning procedure and manual processes. Manual cleaning procedures must follow a written, validated, SOP which details the overall strategy and approach.

Because of the aggressiveness of the chemical agents, the kinetic energy imparted and frequency of their application, the impacts of the cleaning SOP is a significant design requirement.

Ongoing assessment of the efficacy of the cleaning materials and methods will be done through periodic cleaning efficacy tests (See [Section 13.17.6 Cleaning Integrity Test \(CIT\)](#)) and regular viable/non-viable particle testing.

## 13.19.1 Finish Selection for Cleanability

All surface finishes and interface details shall be selected to be compatible with the materials (agents, as well as pads, wipes, etc.) and methods used for cleaning, disinfection or sterilization, without damage or degradation, including discoloration. Materials selected shall have a proven, tested record of performance with the chemical agents listed below, as well as all agents and methods identified by the program that will be used in the facility. Testing shall be performed for each agent individually, and again in sequence, as described in the protocol. If a record of performance with the materials and methods per the protocol is not available, then a mock-up test shall be conducted, documented and passed prior to selection.

Surface finishes shall not be selected based on first-cost, but on a life-cycle cost basis for the facility. Systems shall be impact resistant and shall have smooth, sealed joints and transitions, eased outside corners and coved inside corners.

All materials shall resist damage due to exposure to heat and humidity as anticipated to be encountered in the life cycle of the project to, at, or above highest temperature without degradation below minimum service level for the application.

All finish material selections shall exhibit mold and mildew resistance properties. Products shall be installed over cellulose-free (inorganic-faced) substrates only.

The rotation of disinfectants shall generally consist of two agents, used alternately, with a third agent held in reserve in case of a spike in environmental monitoring, or physical upset at the facility, such as an air-reversal.

Selection of the chemical cleaning agents, in application order, how long, and in what order will they be applied to the surfaces should influence the selection of architectural and MEP design finish selections.



## 13.19.2 Facility Cleaning SOP

The following are key facility considerations when developing the facility cleaning SOP requirements:

1. Select the chemical cleaning agents to be used, in application order.
2. Determine how long and in what order they will be applied to the surfaces. The materials and methods shall be robust enough to ensure adequate kill is achieved, overcoming the inherent variability in the manual cleaning process.
3. The methodology should be developed to minimize inherent variability in the manual cleaning process.
4. The cleaning technicians should be adequately trained in the performance of the specific manual cleaning procedures of the APF they are working on.
5. The manual cleaning procedures of a specific APF should harmonize with a standard/typical SOP for the APF program, and only differ where required to meet specific needs of the APF program.
6. The cleaning technicians should be trained on the inspection acceptance criteria of their work, including mark-removal, tokens, visual inspection, etc.
7. Cleaning procedures should generally specify top-to-bottom, and from cleanest-to-dirtiest areas.
8. The cleaning SOP shall include a section on sink and trap maintenance.
9. Through their APF-specific training, the cleaning technicians should be made aware that varying from the SOP can result in an insufficiently clean facility, endangering patients and research, or can result in severe damage to the facility.
10. Cleaning equipment (mops, handles, buckets, etc.) used in one APF should be dedicated to that facility, and not used across multiple facilities to mitigate cross-contamination risks.
11. The SOP shall clearly specify the following:
  - a. The type of detergents and disinfectants to be used (The agents must be compatible)
  - b. The order and frequency of rotation of disinfectants
  - c. A list of suitable cleaning materials (lint-free wipes, mop heads, etc.)
  - d. Chemical shelf-life
  - e. Chemical concentration and means of assurance
  - f. Cleaning techniques
  - g. Contact times
  - h. Rinsing
  - i. Frequency of cleaning and disinfection
  - j. Procedure for the transfer of cleaning agents and disinfectants into and out of clean areas
  - k. Procedure for sterilization of disinfectants (when utilizing field diluted agents, i.e., non-pre-packaged and ready-to-use – which is preferred)
  - l. Holding times for detergents and disinfectants
  - m. Training requirements
  - n. Documentation requirements
12. Disposal and primary treatment of traps is an essential part of the trap maintenance SOP, but no agents may be placed into the drains unless pre-approved by the Division of Environmental Protection (DEP), ORF. This includes bleach solutions.

### 13.19.3 Cleaning, Sanitizing, and Disinfecting Chemicals

The program shall make the final determination of the agents, sequence, and dwell time requirements of the SOP. The SOP must take into consideration the robustness of the finishes of the facility to avoid pitting of stainless steel, de-bonding epoxies and other degradation.

Provide space for mixing of cleaning solutions at the APF. Programmatically, the trend has been towards the use of premixed chemicals. However, the intent is to preserve the capability to revert to site-mixed/diluted if the program or regulatory needs or requirements change.

Packaged water of the appropriate level may be brought into the APF to mix with the concentrated solutions. Alternatively, a reverse osmosis/deionized (RO/DI), or higher, if required, water outlet may be provided.

**A. Cleaning Chemicals:** These include detergents and surfactants for removing gross surface contamination and bio-burden from the surfaces. Water, the most common cleaning agent, is a polar solvent, often enhanced with detergents or surfactants to make it more effective at removing surface contamination. Some common chemicals in this class include:

1. Detergents
2. Ammonia
3. Calcium hypochlorite (bleach)
4. Sodium hypochlorite (bleach)
5. Citric acid
6. Acetic acid (vinegar)

**B. Sanitizing and Disinfecting Chemicals:** Disinfectants kill vegetative micro-organisms but do not necessarily kill bacterial spores. Disinfectants vary in their modes of action, spectrum of activity, and efficacy. Some are bacteriostatic in which the ability of the bacterial population to grow is halted. Once the disinfectant is removed from contact with bacteria cells, the surviving bacterial population could potentially resume growth. Some common chemicals in this class include:

1. **Non-Oxidizing Disinfectants:** This group includes alcohols, aldehydes, amphoteric,

phenolics, and quaternary ammonium compounds (QACs or “quats.” Phenolics are bactericidal and antifungal, but are not effective against spores).

2. **Oxidizing Disinfectants:** This group includes oxygen-releasing compounds like peracetic acid and hydrogen peroxide.

---

### 13.19.4 Cleaning Air Systems

The supply air (SA), exhaust air (EA), and recirculating air (RA) systems shall be designed, constructed, located, and configuration to facilitate cleaning, maintenance and proper operation.

For APF rooms subject to CFR Part 211 – Current Good Manufacturing Practice for Finished Pharmaceuticals, Subpart C-Buildings and Facilities, Section 211.42.C.10.v, “aseptic processing areas shall be provided with a system for cleaning and disinfecting the room and equipment to provide aseptic conditions”.

This is not interpreted by NIH to generally require a fixed gaseous decontamination system. In lieu, the design of the HVAC systems across all NIH APFs shall accommodate physical decontamination to the extent practicable and configuration of the air handling system per [Section 13.8 APF Design Requirements: HVAC](#) and shall accommodate appropriate isolation and compartmentalization to deploy gaseous decontamination on an as-needed basis, safely.

---

### 13.19.5 Cleaning Protocols

The APF-specific protocols shall include, but not be limited to written procedures that address:

1. Require the use of suitable rodenticides, insecticides, fungicides, fumigation agents and cleaning and sanitation agents to prevent contamination, pre-approved by the facility QA.
2. Prior to installing filters and after room-side, construction-level cleaning has been completed, all ducts walls, ceilings, floors and

installed fittings should be cleaned to remove contamination which could affect the testing for classification of the cleanroom. Only after cleaning should the final filters be fitted and commissioned.

3. Equipment used to clean a particular ISO level should not be used to clean other ISO levels, and shall not be used to clean a more restrictive class than it has already been used to clean (i.e., A mop used to clean an ISO 7 ceiling may, but is not recommended, be used to clean an ISO 8 ceiling, but cannot then be returned to the ISO 7 area for the next cleaning – one way migration).
4. Disposable equipment, such as lint-free wipes should be rated to the ISO class they are cleaning, or better.
5. Vacuum-cleaning equipment either portable or built-in should be provided to ensure that particulate contamination can be removed during periodic cleanings.
6. Plan for contamination generated by any operation that cannot reasonably be conducted outside the APF. See requirements for permanent vacuum in ISO 14644-4 D.1.4.2.
7. Portable vacuums should be fitted with exhaust filter of at least the same efficiency as the HEPA supply in that room (i.e., ISO 7)
8. Protocols shall specify that cleaning occur, from the ceiling-down of the most remote part of the facility, working back towards the entrance to the facility.
9. Protocols should define minimum training requirements, and periodicity/conditions requiring training recertification.

### 13.19.6 Cleaner Qualifications

The cleaning technician, whether contracted, or provided by NIH staff, shall have the same minimum qualifications. The APF-specific SOPs shall define the specific requirements, but the qualifications shall generally include, but not be limited to:

1. Safe use and handling of the cleaning, sanitizing, and disinfecting chemicals
2. The donning and doffing of approved PPE for the APF
3. Proficiency training in APF-specific materials and methods
4. Cleaning validation
5. Cleaning qualification on specific equipment and APF conditions
6. APF cleaning planning and types of cleaning approved for the specific APF
7. Other training, as deemed appropriate for the APF by the facility QA

# Section 13.20

## Operations & Maintenance

---

### Contents

13.20.0 Introduction	13.20.5 Change Control
13.20.1 Standard Operating Procedures (SOP)	13.20.6 Documentation & Storage
13.20.2 Maintenance Program	13.20.7 Spare Parts and “Like for Like” Replacements
13.20.3 Root Cause Analysis (RCA), and Corrective and Preventative Action (CAPA)	13.20.8 Training and Education
13.20.4 Calibration	13.20.9 Auditing

## 13.20.0 Introduction

The maintenance of the cGMP facilities is essential to keeping the facility in a validated state, while in operation. Thus, the maintenance of the APFs plays a critical role in achieving this effort. At NIH, APFs are managed, operated and maintained by the Division of Facilities O&M (DFOM) within the Office of Research Facilities (ORF). In addition to ensuring safety and health of personnel, DFOM maintains facility equipment and systems that support critical process parameters including temperature, relative humidity, pressurization, and environmental conditions in the APF as well as the utilities (i.e., CO<sub>2</sub>, LN<sub>2</sub>, etc.) that serve equipment within the APF. However, laboratory equipment such as refrigerators, incubators, biological safety cabinets, environmental monitoring systems (EMS) are excluded. Bottled lab gases may be excluded from DFOM's responsibility based on user agreements.

APF Operation and Maintenance (O&M) program includes, but is not limited to the following:

1. A Quality Management System (QMS)
2. SOPs
3. Work order plan/order review and approval
4. Corrective maintenance and PM
5. Spare parts management
6. Documentation system
7. Detecting and investigating and correcting maintenance deviations
8. Change control
9. Training
10. Calibration program

DFOM's responsibilities include:

1. Appropriate controls over facility management computer controls and systems (i.e., HVAC, BAS, etc.) to limit changes to critical process parameters.
2. Training of all maintenance personnel (including contractors), on SOPs as well job-specific tasks.

3. Proper labeling/identification of critical and associated equipment is executed
4. Scheduled maintenance activities are tracked and coordinated.
5. Work orders are prepared with sufficient details for review and approval by technical and facility user(s), as well as QA of user group, as needed.
6. Preventive and corrective maintenance plans are developed and executed per SOP
7. RCAs & CAPA are prepared per SOP
8. Reviewed and coordinated contractor's work plans
9. Corrective maintenance procedures, and all associated activities are executed per approved plan
10. CAPAs are executed
11. Approved change control is executed
12. Calibration plans are executed
13. Alerts and alarms are properly responded to
14. Record keeping of all maintenance is executed per SOP
15. Late preventive maintenance is reported per SOP
16. Record keeping of all work orders is executed per SOP
17. Record keeping of all alarms for traceability is executed per SOP
18. Maintenance records are reviewed to identify trends

Facilities Compliance and Inspection Section (DTR/FCIS), Division Technical Resources (DTR), ORF provides independent quality assurance and oversight of DFOM O&M functions in support of the APF owners.

DTR/FCIS responsibilities include:

1. Provide quality assurance for facility regulatory compliance, including certifications, calibration

records, deviations/discrepancy reports, change controls, RCA, CAPA, SOPs, training records, facility audits, etc.

2. Review and approve work orders and conduction inspections of work plan to ensure installations are performed in accordance with plans and that testing is conducted within performance specifications.
3. Regularly review of maintenance records to review trends.
4. Identify O&M improvement.
5. Provide oversight of DFOM CMMS system.
6. Maintains the ORF facility control documents, per [Section 13.20.6](#).
7. Dashboard monitoring and reporting.
8. Conducting periodic internal audits.

---

### 13.20.1 Standard Operating Procedures (SOP)

All NIH APFs shall have approved, signed SOPs for its operations and maintenance; this includes O&M of facility equipment and systems that support critical process systems and associated pieces of equipment. These critical process SOPs shall be followed to prevent any potential negative impact on the final product, manufactured at the facility. The SOPs shall establish and address approved practices and procedures/protocols that describe all aspects of (routine, preventive and corrective) maintenance being performed and administrative controls. SOPs should address both routine, preventive and corrective maintenance.

Training is required for new or amended SOPs and retraining, on a regular schedule not to exceed one year.

---

### 13.20.2 Maintenance Program

The maintenance program of the APF shall address both routine, preventive, predictive and corrective

maintenance; this includes routine calibrations to inspections, to assure proper performance of facility equipment and the maintenance program(s). Maintenance activities may impact systems that support critical process parameters, and environmental conditions in the APF. SOP(s) shall address involve planned or unplanned facility, system or equipment shutdown. Routine maintenance may not require facility shut down but must be scheduled in advance. Maintenance may also require entry into the GMP facility by maintenance staff.

When any new critical equipment or a component is added or removed from the facility maintenance program, it must be documented via change control. Whether the maintenance is planned or emergency there must be an SOP in place that addresses:

1. Roles and responsibilities
2. Clear handover between each activity or shutdown phase
3. Necessary cleaning and sanitization
4. Control over facility access, contractors and changes to facility, process and equipment

**A. Preventative Maintenance (PM):** A Preventative Maintenance Program (PMP) must not only comply with regulatory requirements but be balanced to prevent over-and-under maintaining instruments and equipment. A PMP must be established for any critical piece of equipment affecting the APF and to ensure that mechanical parts that are subject to wear are included in programs for replacement, cleaning and lubrication.

Risk assessments should be conducted for some PM but are not necessary for all PM, based on the criticality and the classification of the equipment.

Major maintenance might require shutdown so must be scheduled and coordinated with the users to provide an opportunity for production to be adjusted accordingly. Post maintenance and/or shutdown may require cleaning and sanitization as follow up to prevent contamination of product when a facility is returned to operation.

**B. Corrective Maintenance:** Corrective maintenance is performed after failure detection. Its purpose is to restore the equipment, machine or an asset to its established limits/specifications.



**C. Predictive Maintenance (PdM):** Predictive maintenance (PdM) techniques are designed to help determine the actual condition of in-service equipment in order to detect the onset of system degradation or, predict when maintenance should be performed. The data produced via PdM should be indicative of current and future functional capability.

PdM differs from preventive maintenance by basing maintenance need on the actual condition of the machine rather than on a preset schedule.

---

### 13.20.3 Root Cause Analysis (RCA), and Corrective and Preventative Action (CAPA)

Root cause identification is an expectation of the FDA and is the most frequently cited problems during regulatory inspections. A through Root Cause Analysis (RCA) Investigation and Corrective and Preventative Action (CAPA) ensures that problems are accurately identified and that the repair is effectively designed, targeting the root cause or error.

Lack of effective corrective action management can lead to repeated System Discrepancy (SD)/deviation. The RCA may be triggered by an alarm from any one of the critical process parameters (such as differential pressure, temperature and humidity) that may affect the quality of the product.

The user can initiate the RCA investigation to address SD/deviation for ORF to conduct the investigation. It is, however, the user's responsibility (and not the ORF) to determine if there is any impact to the product based on the CAPA. Although not all alarms initiate RCA and investigation, as some may be due to false indications (such as someone leaving the door open for a prolonged period), all alarms must be noted and recorded for traceability.

DFOM also conducts internal RCAs and investigations on systems that may indirectly impact the product now but can have a direct impact on the product in the future (predictive). Such deviations shall follow a similar procedure as a direct impact deviation, except user approval may not be required.

Executing a Corrective Action (CA), to prevent recurrence is always immediately required, however, executing a Preventative Action (PA) is NOT always immediately required. This is different from a SD that may or may not require a RCA.

---

### 13.20.4 Calibration

All APF equipment and instrumentation with direct or indirect product impact, must be routinely calibrated traceable to NIST standards, and documented. Written protocols and SOPs shall be established, followed, and documented to ensure these devices are maintained in a calibrated state. Schedules for equipment and instrument calibration must be at appropriate intervals.

The record and results of the calibration and calibration data shall be reviewed and stored with DTR/FCIS, as part of the quality assurance program. See FDA Q7 Good Manufacturing Practice Guidance for Active Pharmaceutical Ingredients Guidance for Industry ICH-Q7: 5.3 for additional recommendations which shall be treated as requirements for the purposes of the NIH APF program.

---

### 13.20.5 Change Control

Change control supports quality, consistency, and protects the integrity of all aspects of the APF that require regulatory control by the FDA. By definition, that includes changes to any direct impact system and may also apply to some indirect impact systems. A change control process/SOP shall be established that solicits the input, review and approval by the user, DFOM, DTR/FCIS and the Change Control Board prior to instituting the change when one or more of the following conditions occur (other similar conditions may also compel this requirement):

1. The change alters the Impact Assessment (i.e., it causes an "Indirect Impact" system to become a "Direct Impact" system, or vice-versa)
2. There is a fundamental change in the design concept

3. The change results in a deviation from the original User Requirement Specification (URS) for the system in question
  4. Where “Like for like” equivalency is not readily achievable
  5. When there’s a change to direct impact systems and critical parameters: (i.e., BAS systems, terminal units, alarms, equipment cleaning, calibrations)
4. Assess the potential impact of the change on:
    - a. System scope, design, or performance requirements (including safety, operability, reliability), construction, commissioning, operations and maintenance.
    - b. Other systems.
    - c. Engineering documentation.
    - d. Qualification documents (including the System Level Impact Assessment).

A quality change control process system may contain the following attributes:

1. Record the name of the originator and date.
2. Describe the change, the affected system or area, and intended purpose.
3. Provide a justification for the change. Such a justification may include, but is not limited to:
  - a. This change required to close a deviation or CAPA.
  - b. This change required to address a current GMP requirement condition.
  - c. This change required to respond to an Inspection Observation? (FDA, Health Authority, Internal Audit, etc.)
  - d. This change required to respond to a non-compliant NIH APF requirement.
  - e. This change required to address a product safety issue.
  - f. This change improves the quality performance of the process, equipment, computer system, facilities, utilities, quality system, or testing.
  - g. This change improves the operational performance of a process or piece of equipment? (Increased volume, reduced lead time, improved productivity, etc.)
  - h. This change addresses/resolves an equipment breakdown or malfunction.
  - i. This change improve the capacity of a piece of equipment, the facility, or the building.

5. Determine if additional testing is required.
6. Describe the type of testing that is necessary. If additional testing is not required, provide rationale.
7. Those who need to know of the proposed change shall be notified per SOP.
8. Record the approval or denial of proposed changes.
9. Track through to completion.

**Note:** Any corrective or non-routine maintenance that can be understood as a change to a validated system or piece of validated equipment, especially parts changes, must be processed through change control before being performed.

Documentation of the installation shall contain:

1. Description of install
2. Function
3. Final and approved test data
4. Conditions at time of install/testing
5. Parts and equipment and spare parts list/source

---

## 13.20.6 Documentation & Storage

Good documentation is essential to NIH APF program's facility quality assurance system and ensures traceability of all O&M activities. The process of

documentation and storage, like other APF processes, must be unambiguous and controlled. Documents must be regularly reviewed, updated, and systematically distributed, tracked, stored and retained, archived or destroyed according to SOPs. Critical records must be stored at a secure location, with access limited to authorized persons. The storage location must ensure adequate protection from loss, destruction, or falsification, and from damage due to fire, water, etc. See also [Section 13.3.10](#) on controlled documents.

A determination must be made as to which records which are critical to regulatory compliance or to support essential business activities. These critical records must be duplicated on paper, electronically, or other appropriate means, and stored in a separate, secure location from the originals.

DTR/FCIS is the designated holder of these documents; however DFOM has the responsibility of storing log books, work orders, work plans, and similar.

Documents held by DTR/FCIS may include, but are not limited to:

1. Engineering studies
2. BOD documents
3. Drawings
4. Specifications
5. Vendor equipment
6. URS
7. Design reviews and reports
8. Deviation reports/CAPA/Change requests
9. Distribution records (for notifications of new or revised documents)
10. Environmental control records (temperature, humidity, pressurization, ACH)/Dashboard reports
11. Vendor testing documents (i.e., TAB, etc.)
12. ISO Certifications/Tests
13. Commissioning, qualification and validation plans

14. Commissioning, qualification and validation protocols and summary reports
15. SOPs
16. Calibration/Certification records
17. Training records
18. Contractor qualifications
19. Other engineering and compliance deliverables
20. Internal audit reports

If documentation is handled by electronic document management system, only authorized persons should be able to enter or modify data in the computer; access must be restricted by passwords or other means; and entry of critical data must be independently checked.

---

### 13.20.7 Spare Parts and “Like for Like” Replacements

A listing of critical Spare parts and consumables shall be maintained and controlled by DFOM to ensure availability of correct replacement parts and consumables when needed.

Availability and storage of quality spare parts is critical to a strong PM/PdM program. A Computerized Maintenance Management System (CMMS) system is used at NIH to track the availability of spare parts for the APF. All PMs must be recorded in CMMS.

The preferred spare part is an identical replacement with the same manufacturer, part number, material of construction and version. Since obtaining an identical part may not be possible, procedure and documentation is required to support a determination of its functional equivalency. Functional equivalency parts are subject to review and approval prior to its use. Where functional equivalency is not easily achievable, additional evaluation or change control is required.

**Note:** “Like-for-like” terminology is used to describe a piece of equipment that is functionally equivalent.

## 13.20.8 Training and Education

Per CFR 211.25, the FDA requires training for personnel engaged in the manufacture, processing, packing or holding of a drug product to have appropriate education, training, and experience, or any combination thereof, to enable that person to perform the assigned functions. The O&M of the facilities where the products are manufactured or compounded, shall institute a quality control system to ensure that staff is adequately trained in the O&M of these facilities. Additionally, training for O&M must also comply with the “ANSI/IACET 1-2013 Standard for Continuing Education and Training”.

The program includes training, retraining and testing scheduled at regular intervals for cGMP implementation related to maintenance functions such as work practices, environmental monitoring (temperature, humidity and differential pressure control), hygiene, verification procedures, corrective action processes, root cause analysis, calibration, preventive action process, record-keeping and review, and sanitation practices.

## 13.20.9 Auditing

APF audits are a thorough inspection of the facility condition, practices, and documentation against the requirements of the URS, SOPs, Key Performance Indicators (KPIs), GDP, GxP, and cGMP. Audits may be external, conducted by regulatory bodies, internal, conducted by NIH staff, or contract SMEs, to assure readiness for external audits. Audits may be routine, announced and planned, or they may be unplanned and unannounced. They may be for cause, or may be for other purposes, unrelated to a for-cause report or event.

Facility audits typically look at:

1. Facility Condition
  - a. Base building O&M program
  - b. APF cleaning and O&M programs

2. Documentation Available and Current
  - a. URS
  - b. Record of work as constructed documents
  - c. Diagrams with airflow patterns, differential pressures, and classification of production areas indicated
  - d. Diagrams with personnel, equipment, supplies, materials, and waste flows indicated
  - e. Facility's SOPs
  - f. CMMS system
3. Facility personnel
  - a. Key Personnel for maintenance, engineering (DFOM) and quality assurance (DTR and FCIS)
  - b. Training records
4. APF Key Performance Indicator (KPI's) Records

**Internal Audits:** The internal audit process for NIH APF quality system is a systematic and independent examination that takes place on a regular schedule, as defined by the APF's SOPs. The goal of an internal audit is to help ensure that proper controls, governance and risk management processes are in place and whether the evaluated activities were conducted, documented, analyzed, and accurately reported on, in conformance with the written SOPs and the GxP and cGMP requirement(s). The auditor shall present objective findings and make recommendations for corrective measures to facilities and processes to the user group, FCIS and DFOM.

# Exhibit 13.1

## APF Questionnaire

The purpose of this questionnaire template is to obtain information necessary to produce the Program of Requirements (POR) for APFs. This questionnaire is a template with additional data fields than the one found in the DRM, Exhibit 2.1. Any data depicted on this template are for illustrative purposes only and are not intended to convey APF requirements.

## 1.0 General Parameters

- 1.1 List all of the institutes/centers to be accommodated in this space.
  - 1.2 Define the research/clinical trial that's proposed by the research program, Clinical Trial Phase level, description of processes that will be performed by the program, the required process environments, types of procedures, and equipment to be used and the resulting product(s).
  - 1.3 Identify project stakeholders and responsibilities.
  - 1.4 Identify project deliverables and responsibilities.
- 

## 2.0 Program Parameters

- 2.1 Describe the product(s) that's being made, its requirements, limitations.
- 2.2 Describe the product path of travel from building level to floor, to suite, to room, to the end user/patient.
- 2.3 Describe the functions that are to be accommodated within the space.
- 2.4 Identify functions that are to be fully segregated
- 2.5 Describe required adjacencies between the functions.
- 2.6 Describe personnel path of travel from building level, to floor, to suite, to room.
- 2.7 Describe the material path of travel from building level, to floor, to suite, to room.
- 2.8 Describe the cleaning regimen to address material storage, cleaning function, personnel, frequency, etc.
- 2.9 Describe program and functions (to include equipment used) that are to be accommodated in the space.
- 2.10 Define quarantine, storage, and decontamination locations and equipment.
- 2.11 Define critical adjacencies.

- 2.12 Define requirements and rationale for compartmentalization of different areas within the facility or any special considerations of note in describing the design intent.
  - 2.13 Identify and conduct risk assessments.
  - 2.14 Define the User, ORSC facility management roles and responsibilities (i.e. Facility Chief, Compliance Officer, etc.).
- 

## 3.0 Regulatory Parameters

- 3.1 Identify the regulatory environment (may consist of one or more regulatory platforms).
  - 3.2 Verify that a risk assessment has been completed and identifies provisions of the assessment that may affect facilities, SOPs, and engineering controls.
  - 3.3 Identify the GxP regulatory parameters that need to be satisfied.
  - 3.4 Perform harmonization analyses, as needed.
  - 3.5 Identify the regulatory environment (may consist of one or more regulatory platforms).
- 

## 4.0 Standard Operating Procedures (SOP)

- 4.1 Define the SOPs that are applicable to the facility Operation & Management.
  - 4.2 Define the Training that are applicable to the facility Operation & Management.
- 

## 5.0 Design Parameters

- 5.1 Airlocks:
  - 5.1.1 Describe when and where are they required.



- 5.1.2 Are combined personnel and material airlocks acceptable?
- 5.1.3 Are combined entry/exit airlocks acceptable?
- 5.2 Is the flow of personnel from less clean to cleaner areas, with increased gowning requirements acceptable?
- 5.3 Define the initial state of control requirements.
- 5.4 Define the function, associated equipment and space requirements.
- 5.5 Describe relationships between functions.
- 5.6 Describe segregation requirements (spatial and temporal).
- 5.7 Describe required ISO levels.
- 5.8 Define facility Critical Process Parameters (CPP) and Critical Quality Attributes (CQA), temperature and humidity to the extent known.
- 5.9 Define critical adjacencies.
- 5.10 Define areas of adequate size and separation and/or other such control systems for the planned operations as necessary to prevent contamination or mix-ups during production (for example airlocks).
- 5.11 Define activities that occur within the processing areas and equipment needs.
- 5.12 Equipment Schedule - to include dimensions, clearances, utilities, emergency power, equipment monitoring.
- 5.13 Room Data Sheets - Use template and develop for each room type.
- 5.14 If drug product, ensure separate and defined areas for: receipt, identification, storage, and withholding from use of components, drug product containers, closures, labeling, etc.
- 5.15 Design provisions for handling any potent narcotic, or high particle-generating materials.
- 5.16 Define any specific requirements for finishes, above and beyond standard APF requirements.
- 5.17 Design provisions for handling any potent narcotic, or high particle-generating materials.
- 5.18 Define boundary conditions of classified and non-classified spaces.
- 5.19 Determine whether conceptual design meets requirements defined in the URS.
- 5.20 Determine cost effectiveness of proposed design.
- 5.21 Define cleaning and sanitizing materials and methods as required to produce aseptic conditions, including agents, sequence and dwell times.
- 
- ## 6.0 Material & Personnel Flow Parameters
- 6.1 Identify and define the logistical flows to be accommodated at the facility to mitigate the risk of cross-contamination, mix-ups, and other risks.
- 6.2 Material Flows:
- 6.2.1 Describe how material enters the facility.
- 6.2.2 How materials flow through the facility?
- 6.2.3 How materials exit the facility?
- 6.3 Personnel Flows:
- 6.3.1 Personnel - How many and function?
- 6.3.2 How personnel enter the facility?
- 6.3.3 How personnel flow through the facility?
- 6.3.4 How personnel exit the facility?
- 6.4 Define levels of PPE donning, PPE doffing, Lines of Demarcation (LOD) and other required features.
- 6.5 Identify need for personnel lockers and level of change, based on PPE donning requirement.

## 7.0 Security System Parameters

- 7.1 Define access control requirements for the facility, and special security zones within the facility.
- 7.2 Define forced-entry protection requirements.
- 7.3 Define closed-circuit video monitoring requirements.
- 7.4 Define required biometric security requirements.
- 7.5 Define secure storage requirements.
- 7.6 Define data and communications security requirements.
- 7.7 Define facility hardening and critical utility requirements.

## 8.0 Mechanical System Parameters

- 8.1 Define the specific HVAC parameters for adequate control appropriate for the manufacture, processing, packing, or holding of a drug or biologic.
  - 8.1.1 Temperature
  - 8.1.2 Relative Humidity
  - 8.1.3 ISO Classification
  - 8.1.4 Air Changes Per Hour
  - 8.1.5 Differential Pressure and Airflow Directionality
- 8.2 Define the necessary parameters for adequate control over air supply, including filtration; whether flow is unidirectional and non-turbulent.
- 8.3 Define Supply Air (SA) requirements, including single pass and recirculating/re-filtered air.
- 8.4 Define consideration for system reliability and robustness.
- 8.5 Define utility requirements and feasibility.

- 8.6 Design spatial requirements for locating mechanical equipment and terminal units and devices.
- 8.7 Define a BAS and EMS validated system for monitoring environmental conditions.
- 8.8 Define zoning requirements to enable partial shutdowns of the facility (defined areas within the facility).
- 8.9 Define mechanical space, including interstitial access (should be from outside the APF).

## 9.0 Plumbing System Parameters

- 9.1 Define specific compressed gases and liquid such as CO<sub>2</sub>, CA, LN<sub>2</sub>, etc. for adequate control appropriate for manufacture and processing and holding of a drug or biologic.
- 9.2 Define specific vacuum appropriate for manufacture of drug or biologic.
- 9.3 Define specific pure water for adequate control appropriate for manufacture and processing of a drug or biologic.
- 9.4 Identify if any sinks are required and associated emergency eye washes or showers.

## 10.0 Electrical System Parameters

- 10.1 Define emergency and stand-by power requirements for the facility.
- 10.2 Define program lighting requirements, including level (in Lux or foot-candles), uniformity, temperature and color rendering index (if different from 3,500°K (6,300°F) and 80 CRI).
- 10.3 Identify any higher densities of 120V receptacles than normally provided.

- 10.4 Identify receptacles other than standard 120V receptacles, other specialty electrical wiring devices or other utilization requirements.
  - 10.5 Identify any laboratory equipment requiring emergency power.
  - 10.6 Identify any special grounding requirements.
  - 10.7 Identify any scientific equipment monitoring or unique power or UPS requirements.
- 

## **11.0 Facility Operations & Maintenance Parameters**

- 11.1 Define maintenance/calibration requirements for equipment.
- 11.2 Define elements of the HVAC and other systems that may require decontamination and preferred method of decontamination.
- 11.3 Identify standard operating procedures for facility shutdown and maintenance of the facility during shutdown.
- 11.4 Define failure modes on critical equipment/systems.
- 11.5 Define backup, recovery, and restoration of critical equipment/systems.

# Exhibit 13.2

## APF Room Data Sheet

The purpose of this room data sheet template is to obtain information necessary to produce the Basis Of Design (BOD) for APFs. This exhibit is a template and includes additional data fields compared to the one found in the DRM, Appendix F, Room Data Sheets. Any information depicted on this template is for illustrative purposes only and is not intended to convey APF requirements.

## Lab Type: APF Cleanroom

Project: Room Name:

WR Number: Room Number:

Date:

1. Room Data		Other Special Requirements
a. Size/Dimensions	(1) module, 11' width	Anteroom required for gowning with bench, PPE storage, waste bins
b. BSL	BSL-3	
c. Ceiling height	2,896 mm (9'-6") minimum	
d. Door size	1,200 mm (4'-0")	Active leaf 900 mm (3'-0"); inactive leaf 300 mm (1'-0")
e. Door type	Aluminum-Framed Cleanroom Swing Door, Full Lite	Card key access control
f. Access Control	Red-Light/Green-Light Indicator	
g. Windows	Aluminum-Framed Cleanroom Window	
h. Normal occupancy	4	
i. Special requirements	Confirm with program	All surfaces cleanable; sticky mats at entrance; all penetrations sealed
2. Finishes		Other Special Requirements
a. Floor	Seamless sheet vinyl, Welded	
b. Base	6" vinyl, integral with floor	Reinforced, factory formed coved corners
c. Wall type	High Performance Composite Wall System	Bubble-tight stainless steel access panel, where required
d. Wall Protection	Stainless steel, Low Carbon (304L or 316L)	Full-height cornerguards, and fully adhered scuff plates, gapped 1/2"
e. Ceiling type	High Performance Composite Ceiling System	Bubble-tight stainless steel access panel, where required
3. Furnishings and Fittings		Other Special Requirements
a. Casework	Stainless steel, Low Carbon (304L or 316L)	Minimize casework to promote cleanliness; use tables and carts where possible
b. Bench top	Stainless steel, Low Carbon (304L or 316L)	
c. Sink(s)	No	
d. Piped services	No	
e. Flammable storage cabinet	Yes	
f. Vented corrosive storage cabinet	No	
g. Other	Minimize horizontal surfaces	

4. Equipment – See Equipment List for Additional Items		Other Special Requirements												
a. Biological safety cabinets	(1) 6', class II, type A2	Vacuum in BSC												
b. Laminar flow hood (LFH)	No													
c. Compounding aseptic isolator (CAI)	No													
d. Containment isolator (CACI)	No													
e. Compounding safety enclosure (CSE)	No													
f. Restricted access barrier system (RABS)	No													
g. Controlled rate freezer (CRF)	No													
h. -20/-30/-80 Laboratory freezer	No													
i. Incubator	No	Water jacketed, CO <sub>2</sub> , N <sub>2</sub> , and air												
j. Microscope	Yes	Phase contrast, photo port												
k. Other														
5. HVAC Requirements	Min Regulatory Value	Min Alarm Setpoint	Setpoint	Max Alarm Setpoint	Max Regulatory Value	Alarm Delay								
a. Temperature	25°C (59°F)	16°C (60.8°F)	20°C (68°F)	21°C (69.8°F)	22.2°C (72°F)	2-Min								
b. Relative humidity	N/A	N/A	40% RH	42% RH	50% RH	2-Min								
c. Differential pressure	0.020 IWC	0.025 IWC	0.033 IWC	0.035 IWC	N/A	2-Min								
6. HVAC System Description	Notes													
a. Iso class	ISO 7													
b. Airflow type	Unidirectional													
c. Supply air	472 LPS (1,000 CFM) Ceiling HEPA diffusers													
d. Exhaust air	377.6 LPS (800 CFM) low sidewall grille, 47.2 LPS (100 CFM) door undercut													
e. Recirculation air	472 LPS (1,000 CFM) Ceiling HEPA diffusers													
f. Relative pressure	12.5 Pa (0.05 " WC) positive to anteroom													
g. BAS Sensors	TEMP, RH, dP, and Door Position Red/Green Light													
h. EMS Sensors	TEMP, RH, and dP													
7. Piping/Plumbing	CHW	CW	PW	HW	OTHER	CO <sub>2</sub>	AIR	VAC	LN <sub>2</sub>	WASTE	STEAM	FD		
a. Utility	No	No	No	No	No Condensate	Yes	No	Yes	No	No	No	No	No	No
b. Other	Piping services as determined by program													
8. Electrical		Other Special Requirements												
a. Power receptacles	Yes	General purpose NEMA 5-20R receptacles, cast boxes and conduits sealed												
b. Lighting	Recessed cleanroom LED luminaire	Lighting lensed, sealed, gasketed, wet location listed, with overlapping door												
c. Telephone/Communication	Yes													
d. Data/Computer	Yes													
e. Emergency power	Yes	Emergency power for equipment per equipment list												
f. Standby power	No													
g. Task lighting	Yes													
h. Other														



# Exhibit 13.3

## APF Certificate of Use Checklist

The purpose of this checklist is to clarify and consolidate the requirements for obtaining a DTR/FCIS Certificate of Use for an APF. This depicts a typical, generic flow and may not represent an inclusive, or specific listing for a particular APF project or facility.

## 1.0 Document Handover

- 1.1 User Requirements Specification (URS)
- 1.2 Basis of Design (BOD)
- 1.3 Calculations
- 1.4 Record Drawings
- 1.5 Record Specifications
- 1.6 Record Submittals
- 1.7 Commissioning Report (Cx Report)
- 1.8 Installation Qualification (IQ)
- 1.9 Operation Qualification (OQ)
- 1.10 Performance Qualification (PQ)
- 1.11 URS Traceability Matrix
- 1.12 Training Documents
- 1.13 SOPs
- 1.14 ISO Clean Room Certification Report
- 1.15 Air Visualization Studies (AVS)
- 1.16 Testing and Balancing Report
- 1.17 HEPA and BSC/LAFW/CACI/CAI Certs
- 1.18 Calibration Reports
- 1.19 Use and Occupancy Permits
- 2.5 Adequate particle counts during static and dynamic conditions
- 2.6 Adequately holding uniform temperature
- 2.7 Adequately holding relative humidity
- 2.8 Adequately providing uniform illuminance
- 2.9 Adequately providing less than the allowable noise and vibration
- 2.10 BSC/CAI/CACI/LAFW have been adequately tested and certified
- 2.11 Material seams and transitions have been adequately detailed and implemented
- 2.12 Finishes are appropriate and have been adequately detailed and implemented
- 2.13 DFOM and User have been adequately trained to operate and maintain the facility
- 2.14 BAS and EMS have been adequately designed/ coordinated, implemented and functioning
- 2.15 Door interlocks and administrative controls adequately control airflow
- 2.16 Adequate recovery of differential pressure in rooms after door cycles
- 2.17 Compressed gases, LN<sub>2</sub> and pure water are adequately tested and certified

---

## 2.0 Facility Demonstration

- 2.1 Adequate HEPA filtered airflow supplied and proper airflow velocities
- 2.2 Unidirectional airflow in cleanroom spaces and that air flows from cleaner to less clean areas
- 2.3 Adequate differential pressure and displacement airflow between rooms of different cleanliness purpose and classification
- 2.4 Demonstrated HEPA filters are adequately leak-free

# Exhibit 13.4

## Aseptic Project Execution Plan (PEP) Checklist

The purpose of this checklist is to illustrate a generic Project Execution Plan outline for an APF project or facility. This depicts typical/generic content and may not represent an inclusive, or specific listing for any particular APF project or facility.

## 1.0 Project Overview

- 1.2 Change Log
  - 1.3 Contract and MOU Basis
  - 1.4 Project Objective
  - 1.5 Execution Strategy
- 

## 2.0 Design Management

- 2.1 User Requirements Specification (URS)
  - 2.2 Basis of Design (BOD)
  - 2.3 Construction Drawings and Specs
  - 2.4 Calculations
  - 2.5 Commissioning Plan (CP)
  - 2.6 Construction Quality Plan (QQP)
  - 2.7 Qualification and Validation Plan (QVP)
  - 2.8 Design Qualification
- 

## 3.0 Construction Management

- 3.1 Construction Submittals
- 3.2 Field Engineering
- 3.3 Permits and Inspections

## 4.0 Construction Quality Management

- 4.1 Quality Audit Plan
  - 4.2 Quality Reports
  - 4.3 Corrective Action Program
  - 4.4 Testing and Evaluation
  - 4.5 Commissioning Report (Cx Report)
  - 4.6 Installation Qualification (IQ)
  - 4.7 Operation Qualification (OQ)
  - 4.8 Performance Qualification (PQ)
  - 4.9 URS Traceability Matrix
- 

## 5.0 Construction Close-Out

- 5.1 Close Out Documents
  - 5.2 Transition to Operations Plan
- 

## 6.0 Operations and Maintenance

- 6.1 DFOM SOPs
- 6.2 Training Documents
- 6.3 Audit Logs
- 6.4 Activity Logs
- 6.5 Current Status Documents (Record Documents)

# Exhibit 13.5

## APF Tests Roles and Responsibilities

The intent of APF facility certification is to ensure protection of patients, products, and workers. Refer to Section 13.17 for detailed information on specific APF facility certification requirements. The specific types and periodicity of re-testing is established in APF-specific SOPs.

SR	Tasks	Construction Contract	Commissioning Contract	Qualification / Validation Contract	NIH (ORF/ORS)	NIH (USER/ORSC)
1	Testing and Balancing	P	W	R	M/R	M
2	BSC Certification	W	W	R	P	R
3	Pressurization, Temperature and Humidity Verification	W	P/R	P/R	M/R	M/R
4	Four Season Performance	W	P	R	M/R	M
5	BAS vs EMS Coordination	R	W	P	M/R	M/R
6	Air Flow Test (Include Velocity and Air Flow Rate)	R	R	P	M/R	M/R
7	Air Visualization Testing (Smoke Studies)		R	P	M/R	M/R
8	HEPA Filter Integrity Testing (Leakage Testing)	P/R	W	P	P/R	M/R
9	Airborne Particle Count Cleanliness Classification Test		R	P	M/R	M/R
10	HVAC, Gases, LN <sub>2</sub> , Pure Water IOPQ	R	P	P	M/R	M/R
11	Pressurization Testing	R	R	P	M/R	M/R
12	Room Temperature and Humidity Uniformity Test	R	R	P	M/R	M/R
13	Lighting Illuminance Test	M	P	R	M/R	M/R
14	Room Recovery Testing	M	R	P	M/R	M/R
15	Room Integrity (Leak) Testing	M	R	P	M/R	M/R
16	EMPQ	N/A	R	R	R	P
17	User Equipment IO/PQ	N/A	R	R	R	P
18	EMS IO/PQ	M	W	W	R	P

*P Perform*  
*W Witness*  
*R Review*  
*M Monitor*  
*N/A Not Applicable*

*Note: The RACI Test Matrix is typical, but can be adjusted based on the project requirements, size of the project, available contracts in place, capabilities of the various teams involved in the project as long as the prime or their subcontractors meet the required qualifications to perform the work.*



# Exhibit 13.6

## APF Sealant Table

All material interfaces and penetrations into and through partitions, floors, and ceilings shall be sealed to enhance sanitation, facilitate gas and vapor decontamination, and resist air infiltration. The table found here is specifically for use in selecting and detailing sealants for use within the APF suite. This table is based on the Sealant Table found in DRM Appendix L. Refer to that table for use outside the classified spaces and for General Sealant Notes. Sealants shall be applied in a uniform, smooth, and continuous manner, resulting in a finish free of voids, pinholes, sharp edges, or excess sealant. Sealant must be compatible with all material that it is in contact with, including other sealant. Sealant must have chemical resistance, flexibility, durability, adherence, and other characteristics appropriate for its use.

**Key:**

JS Joint Sealant

N/S No Sealant

N/A Not applicable

\* Refer to Comments

**Sealant Types:**

JS-3 Siliconized Acrylic Latex ASTM C834 (Note: Latex plus silicone is not an acceptable product)

JS-4 Non-Halogenated Latex-Based Elastomeric Sealant ASTM C920

JS-5 Mildew Resistant, 100% Silicone ASTM C920

Group	Description	USP <795>	USP <797>	USP <800>	USP <823>	21CFR211 cGMP	Comments
Doors	Seal all penetrations in doors	JS-5	JS-5	JS-5	JS-5	JS-5	Cleanroom doors should have minimal penetrations
	Seal all door hinge plates (not at pin)	JS-5	JS-5	JS-5	JS-5	JS-5	
	Seal door frame and wall interface	JS-5	JS-5	JS-5	JS-5	JS-5	Some systems may not have a joint here
	Seal lite frames (around glass whether or not gasketed)	JS-5	JS-5	JS-5	JS-5	JS-5	Interior and exterior sides
	Seal around lock sets	JS-5	JS-5	JS-5	JS-5	JS-5	Seal between escutcheon plates and door
	Seal around all sides of latch boxes installed within frames	JS-5	JS-5	JS-5	JS-5	JS-5	
	Seal door thresholds to the floor and around the threshold	N/A	N/A	N/A	N/A	N/A	Thresholds should be avoided in APFs. Some regulatory environments preclude caulking to floor (i.e. USP <797>) even where thresholds are required.
	Seal door protection plates and tapered door guards to doors	JS-5	JS-5	JS-5	JS-5	JS-5	
	Seal gaps around door magnet latch at head of door and frame	JS-5	JS-5	JS-5	JS-5	JS-5	
	Seal gaps around door door closer at head of door and frame	JS-5	JS-5	JS-5	JS-5	JS-5	Do not caulk closer cover in place (needs to be removable for service)
Cabinetry/ Shelving	Seal openings in the base of tables where the support feet mount to the table	JS-5	JS-5	JS-5	JS-5	JS-5	
	Seal openings in table legs where the support feet mount to the floor	JS-5	N/A	N/A	JS-5	JS-5	
	Seal all cabinets where they contact dissimilar materials and where they contact one another	JS-5	JS-5	JS-5	JS-5	JS-5	Cabinets need to be closed boxes. Seal all voids and joints in cabinet construction. Seal all removable panels. Provide stainless steel closure panels as required to fill large or multiple holes, fully adhered and sealed.
	Seal all counter tops where they contact with dissimilar material	JS-5	JS-5	JS-5	JS-5	JS-5	
	Seal around all shelf support brackets where they contact the shelves and are mounted to the walls	JS-5	JS-5	JS-5	JS-5	JS-5	This is for specialty shelving used in laboratories. Provide stainless steel closure panels as required to fill large or multiple holes, fully adhered and sealed.
	Seal tops and bottoms of all wall mounted shelving brackets	JS-5	JS-5	JS-5	JS-5	JS-5	Provide a pre-manufactured plug and seal
	Seal all gaps and openings in racks	JS-5	JS-5	JS-5	JS-5	JS-5	Provide stainless steel closure panels as required to fill large or multiple holes, fully adhered and sealed.
	Seal covers between shelf standards	JS-5	JS-5	JS-5	JS-5	JS-5	Provide a pre-manufactured cover and seal
Seal peninsula shelving support at countertop and at ceiling	JS-5	JS-5	JS-5	JS-5	JS-5		

Group	Description	USP <795>	USP <797>	USP <800>	USP <823>	21CFR211 cGMP	Comments
Walls/ Floors/ Ceilings	Seal around all wall guards, bumpers, and rails	JS-5	JS-5	JS-5	JS-5	JS-5	Brackets/fasteners shall be installed tight to wall.
	Seal all penetrations on the top and bottom of slab	JS-5 over JS-4	JS-5 over JS-4	JS-5 over JS-4	JS-5 over JS-4	JS-5 over JS-4	To include but not limited to HVAC, plumbing, and electrical penetrations, and like penetrations through interstitial space. Install JS-4 to within 1/8" of surface, cure, then install JS-5 above and finish.
	Seal around all corner guards	JS-5	JS-5	JS-5	JS-5	JS-5	Stainless steel corner guards shall be installed tight to wall, fully adhered, and full height.
	Seal around all door bumpers and scuff plates	JS-5	JS-5	JS-5	JS-5	JS-5	Scuff plates shall be installed fully adhered to wall and sealed. Guard brackets/fasteners shall be installed tight to wall, then sealed.
	Seal top of trim strip and sheet flooring at wall	JS-5	JS-5	JS-5	JS-5	JS-5	A cleanroom termination detail is required.
	Seal top of cove base	JS-5	JS-5	JS-5	JS-5	JS-5	
	Seal bottom of cove base	JS-5	JS-5	JS-5	JS-5	JS-5	Integral base required in BSL-3, ABSL-3 and ABSL-2
	Seal all ceiling access panels (whether or not 100% gasketed)	JS-5	JS-5	JS-5	JS-5	JS-5	
	Seal the perimeter of all cleanroom ceiling grid to the wall	JS-5	JS-5	JS-5	JS-5	JS-5	
	Seal the perimeter of all cleanroom ceiling tiles to grid (whether or not 100% gasketed)	Optional	JS-5	JS-5	JS-5	Optional	
	Seal all interior window frames	JS-5	JS-5	JS-5	JS-5	JS-5	Seal all joints, including stops, juncture to glass and screw heads
	Seal around wall and ceiling, surface-mounted cover and mounting plates	JS-5	JS-5	JS-5	JS-5	JS-5	
	Seal all around floor surface mounting plates	N/A	N/A	N/A	N/A	N/A	Floor surface mounting plates shall be avoided in APFs.
	Seal all around floor surface-mounted cover plates	N/A	N/A	N/A	N/A	N/A	Floor surface cover plates shall be avoided in APFs.
	Seal and cap the tops of all CMU walls	N/A	N/A	N/A	N/A	N/A	CMU walls are prohibited in APFs.
	Seal control joints in walls	JS-5	JS-5	JS-5	JS-5	JS-5	
	Seal control joints in ceilings	JS-5	JS-5	JS-5	JS-5	JS-5	
	Seal control joints in floors	N/A	N/A	N/A	N/A	N/A	Not visible to room – beneath floor. Use sealants recommended by flooring manufacturer under resinous floors
	Seal joints between walls of dissimilar materials	JS-5	JS-5	JS-5	JS-5	JS-5	
	Seal space in wall penetrations, including inside sleeves, collars, and surrounding construction	JS-5	JS-5	JS-5	JS-5	JS-5	Provide stainless steel closure panels as required to fill large or multiple holes, fully adhered and sealed.
HVAC	Seal all duct work that penetrates the wall envelope	JS-5	JS-5	JS-5	JS-5	JS-5	Use of JS-3 outside of controlled spaces per Appendix L is acceptable.
	Seal all diffusers/grill joints and room-side HEPA housings in hard ceilings	JS-5	JS-5	JS-5	JS-5	JS-5	

Group	Description	USP <795>	USP <797>	USP <800>	USP <823>	21CFR211 cGMP	Comments
Plumbing	Hot water line insulation shall be wrapped in aluminum and the seams and ends of the insulation sealed	N/A	N/A	N/A	N/A	N/A	
	Seal at vacuum pass through	JS-5	JS-5	JS-5	JS-5	JS-5	
	Seal all cracks in foam rubber water line insulation	N/A	N/A	N/A	N/A	N/A	
	All flat escutcheon plates and support standoff brackets for animal water systems shall be sealed all around	N/A	N/A	N/A	N/A	N/A	
	Seal plumbing to surface	JS-5	JS-5	JS-5	JS-5	JS-5	
	Seal all plumbing escutcheon and cover plates at the wall and pipe junctions	JS-5	JS-5	JS-5	JS-5	JS-5	
	Seal around sprinkler collars	JS-5	JS-5	JS-5	JS-5	JS-5	Seal inside and outside of collar. Confirm that sealant does not interfere with sprinkler operation.
	Seal all piping that penetrates the wall envelope	JS-5	JS-5	JS-5	JS-5	JS-5	
Electrical	Conduit and raceway shall be sealed tight to wall or ceiling surfaces	JS-5	JS-5	JS-5	JS-5	JS-5	Sealant is required on both sides of surface mounted conduit and raceway.
	Seal the perimeter of all electrical panels	N/A	N/A	N/A	N/A	N/A	Panelboards are precluded from installation in APF controlled spaces.
	Seal joints between ceiling and light fixtures in hard ceilings	JS-5	JS-5	JS-5	JS-5	JS-5	Surface and recessed mounted lighting fixtures shall have sealant applied between fixture enclosure and ceiling surface. Recessed mounted fixtures shall have manufacturer's gasketing applied between fixture lens trim cover and adjacent ceiling surfaces.
	Seal perimeter of device boxes to adjacent drywall/CMU. Wire within conduit shall be sealed also.	JS-5	JS-5	JS-5	JS-5	JS-5	Applicable for ALL power, communications, signal and control applications within APF facilities: All device boxes shall be cast type with external hub. Where device boxes and conduits are recessed mounted, the box to the adjacent wall, ceiling or floor surface shall be sealed. Gasketed device cover plates shall be used, with an additional continuous bead of sealant between the device box cover plate and the adjacent surface. Where device boxes and conduits are surface mounted, and where the device box meets the wall, ceiling, or floor surface, a continuous bead of sealant shall be provided. Once wiring is installed, the wiring shall be surrounded by a one inch barrier of caulking around the conductors within the device box hub.

Group	Description	USP <795>	USP <797>	USP <800>	USP <823>	21CFR211 cGMP	Comments
Equipment	Seal all fixed equipment that is within 38 mm or less from a ceiling	JS-5	JS-5	JS-5	JS-5	JS-5	
	All sinks shall be sealed, including mounting and support brackets	JS-5	JS-5	JS-5	JS-5	JS-5	
	Large gaps, behind the back splash shall be completely covered and sealed.	JS-5	JS-5	JS-5	JS-5	JS-5	
	Seal all gaps and openings in secured/fixed equipment	JS-5	JS-5	JS-5	JS-5	JS-5	May hinder function of equipment – Review on a case-by-case basis.
	Seal gaps that exist between stainless steel sheet metal in all cage washers	N/A	N/A	N/A	N/A	N/A	Not permitted in APFs.
	Seal gaps that exist between stainless steel sheet metal in all tunnel washers	N/A	N/A	N/A	N/A	N/A	Not permitted in APFs.
	Seal gaps that exist between stainless steel sheet metal in all rack wash equipment	N/A	N/A	N/A	N/A	N/A	Not permitted in APFs.
	Seal around frames and holes inside of fire extinguisher boxes	JS-5	JS-5	JS-5	JS-5	JS-5	Some doors have hollow channel in access doors. Seal access door frame channels and glass cover where no clips are present.
	Seal around the metal rod hangers used to hold the exhaust hoods where they penetrate the drop ceiling	JS-5	JS-5	JS-5	JS-5	JS-5	
	Seal wall-mounted heating/air conditioner unit casework and utility penetrations	N/A	N/A	N/A	N/A	N/A	Not permitted in APFs.
	Seal floor mounted equipment supports, legs and standoff supports	N/A	N/A	N/A	N/A	N/A	Floor surface mounting shall be avoided in APFs.
	Fixtures	Seal stainless steel equipment at all joints and gaps	JS-5	JS-5	JS-5	JS-5	JS-5
Seal toilet mounted to surface		N/A	N/A	N/A	N/A	N/A	Not permitted in APFs.
Seal sink faucet mounted to surface		JS-5	JS-5	JS-5	JS-5	JS-5	
Seal wall hung equipment at surface attachment		JS-5	JS-5	JS-5	JS-5	JS-5	

# Appendix



# Appendix A

## Biological Safety Cabinet (BSC) Placement Requirements for New Buildings and Renovations

---

### **Farhad Memarzadeh, Ph.D., P.E.**

Division of Technical Resources  
Office of Research Facilities  
National Institutes of Health

### **References:**

*Microbiological Safety Cabinets: Recommendations for Cabinet Installation.* British Standards Institution, BS 5726:2005.

*Methodology for Optimization of Laboratory Hood Containment.* Memarzadeh, F. National Institutes of Health, 1996.

### BSC Workspace:

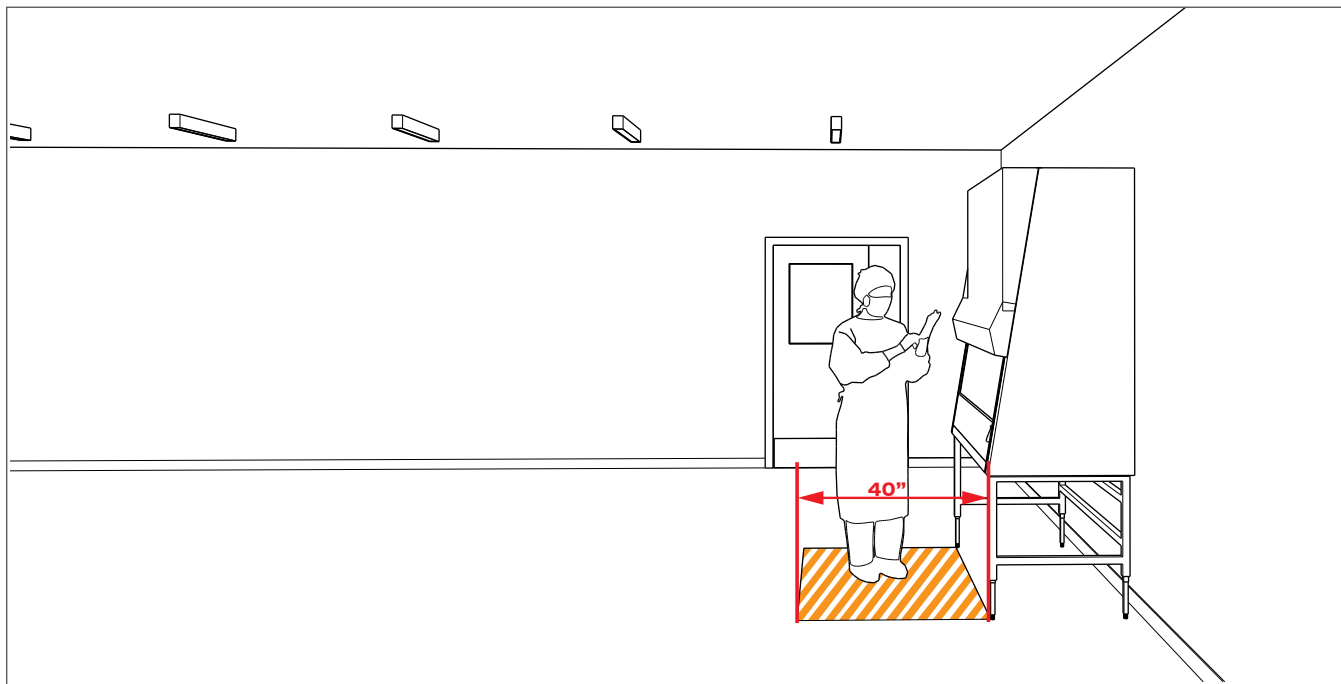

Maintain an undisturbed space of 40" around the BSC.

### Distance to Adjacent Walls & Columns:

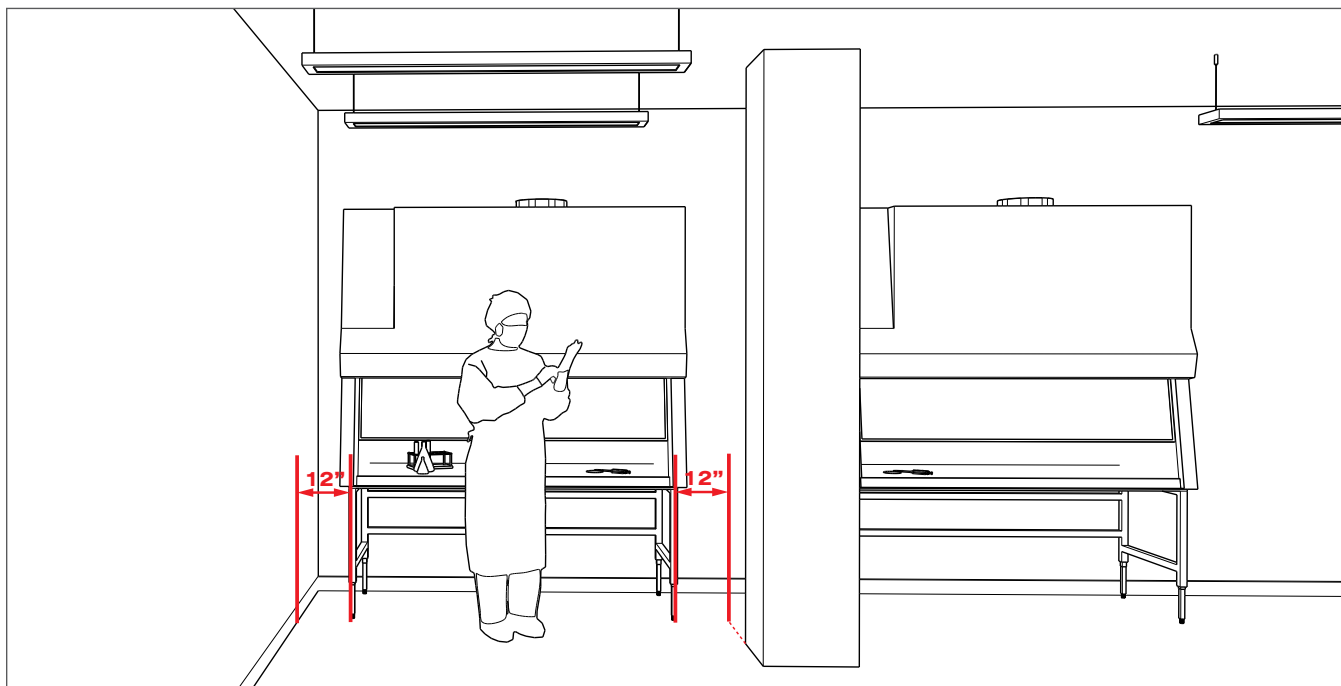

Maintain a distance of 12" to adjacent walls & columns. Note: columns can aid in defining traffic routes.

### Distance to Opposing Walls:

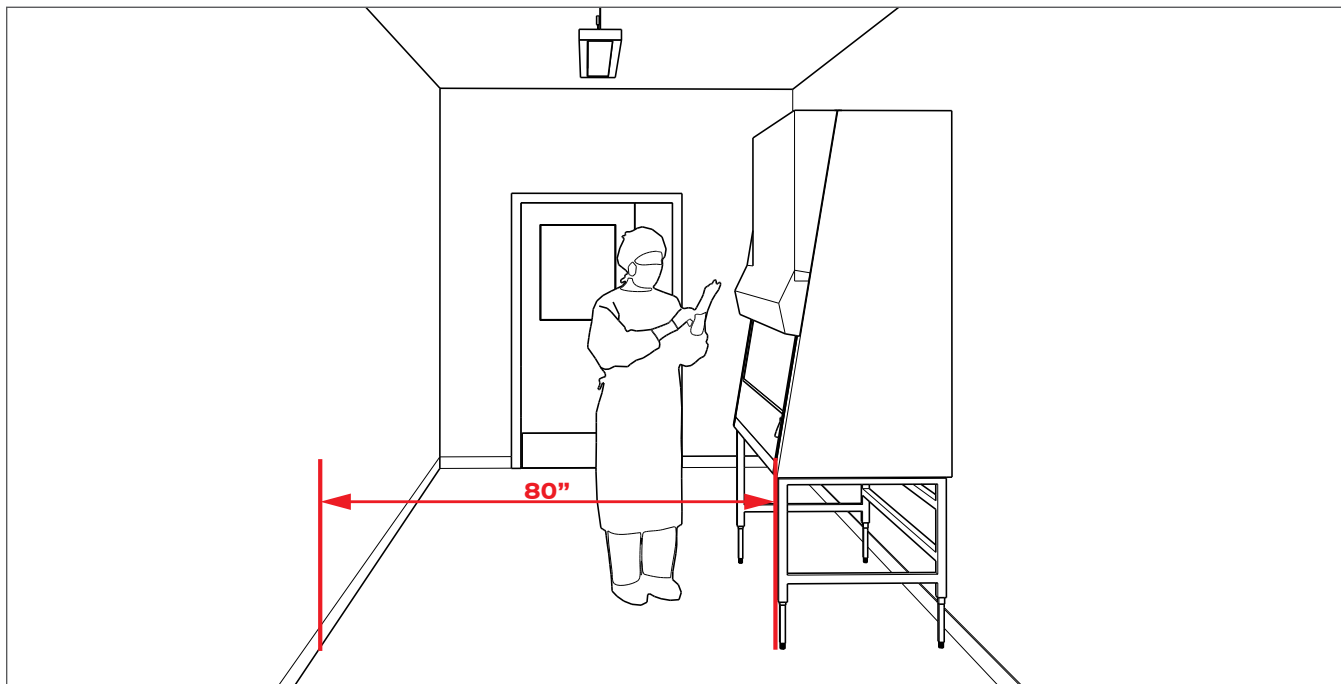

Place BSCs at least 80" from opposing walls.

### Distance to Opposing Bench Tops:

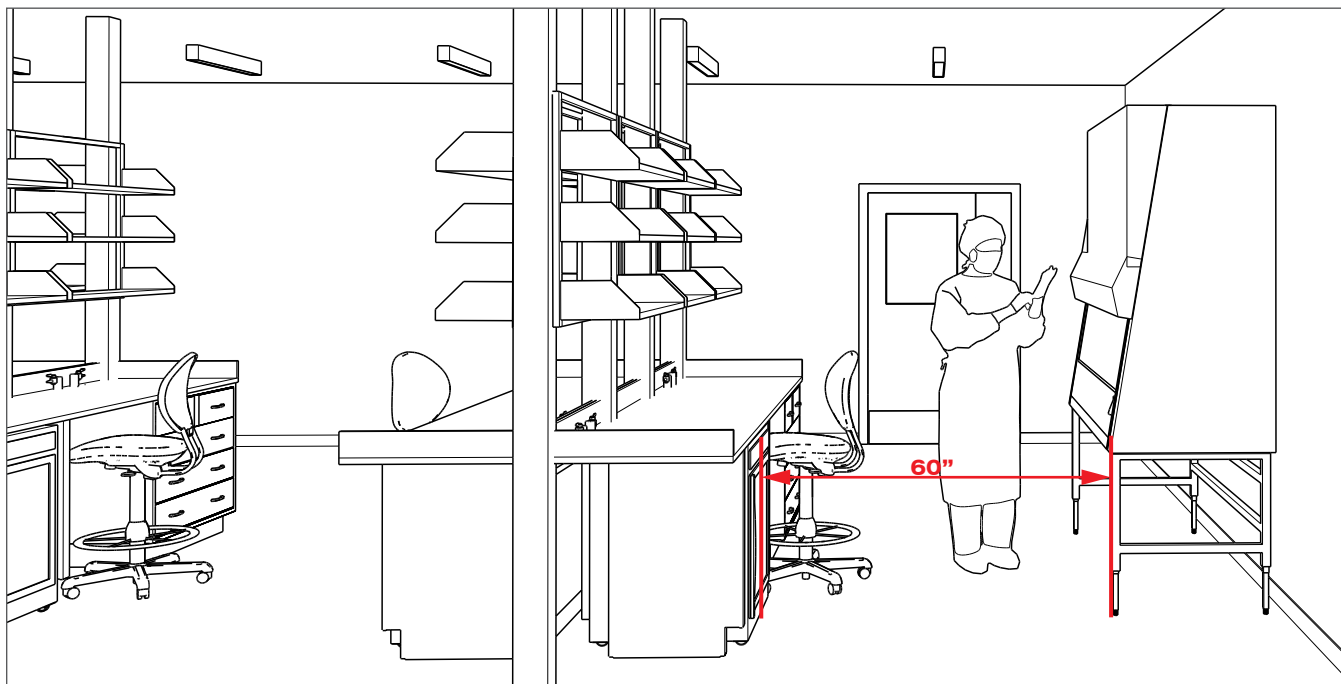

Place BSCs at least 60" to opposing bench tops or areas with occasional traffic.

### Distance to Adjacent Bench Tops:

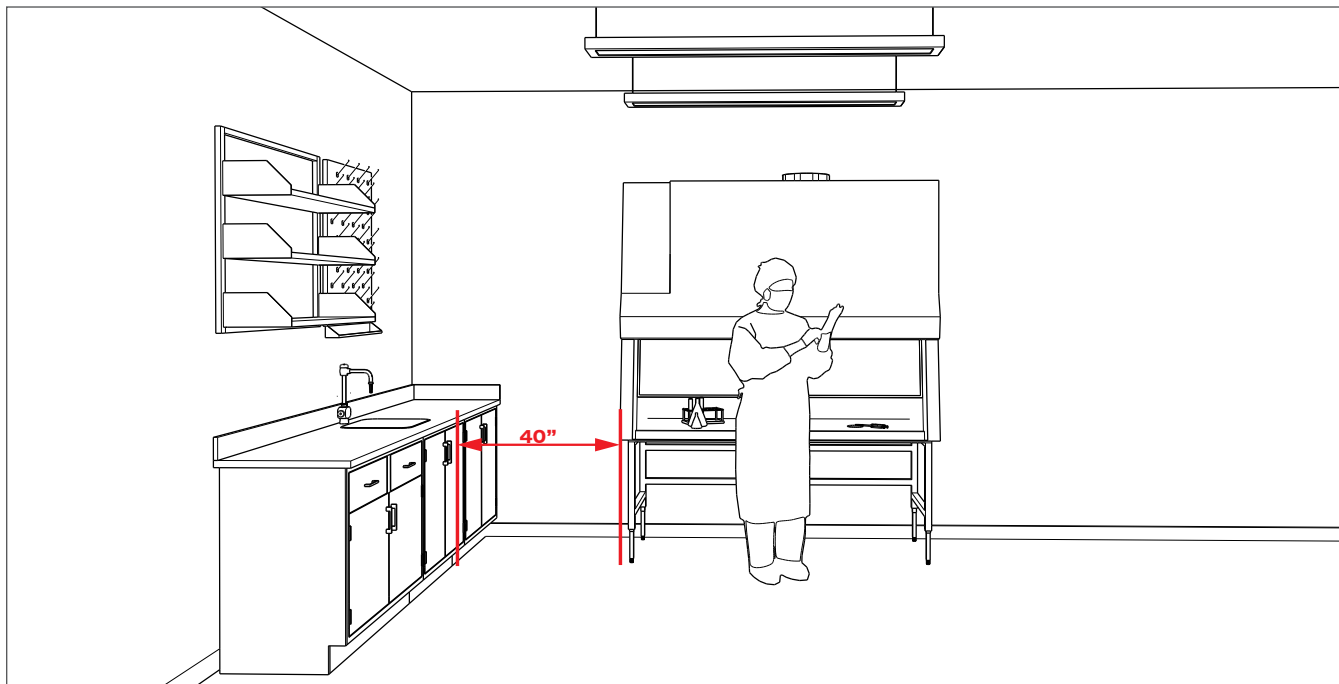

Maintain a distance of 40" between BSC and bench tops along a perpendicular wall.

### BSC Placement Along Opposing Walls:

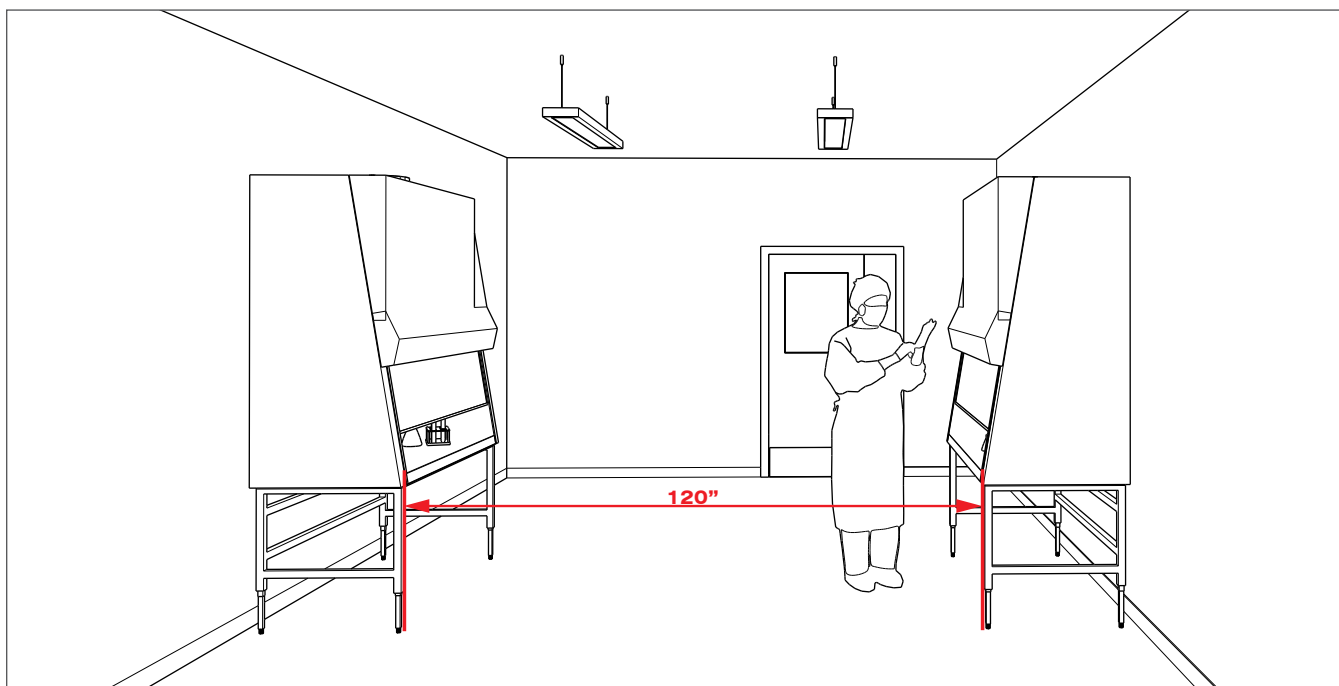

Maintain a distance of 120" between BSCs on opposing walls.

### BSC Placement Along the Same Wall:

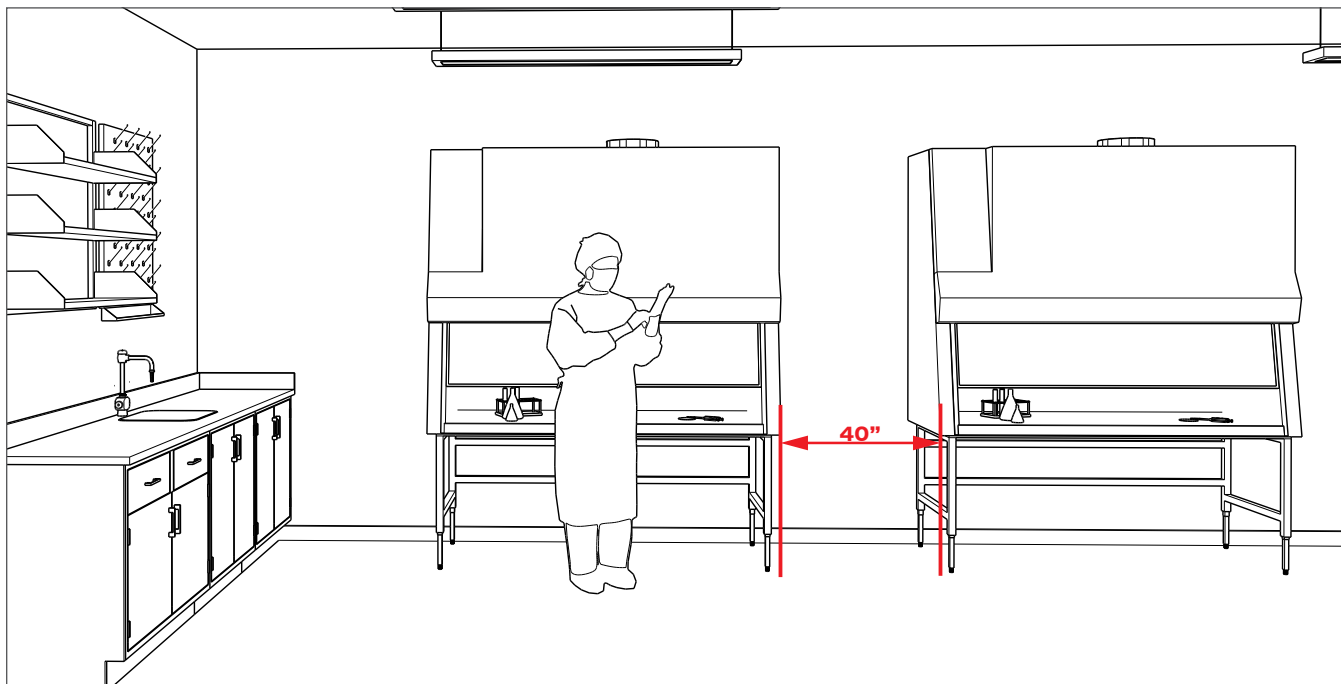

Maintain a distance of 40" between BSCs along the same wall.

### BSC Placement Along Perpendicular Walls:

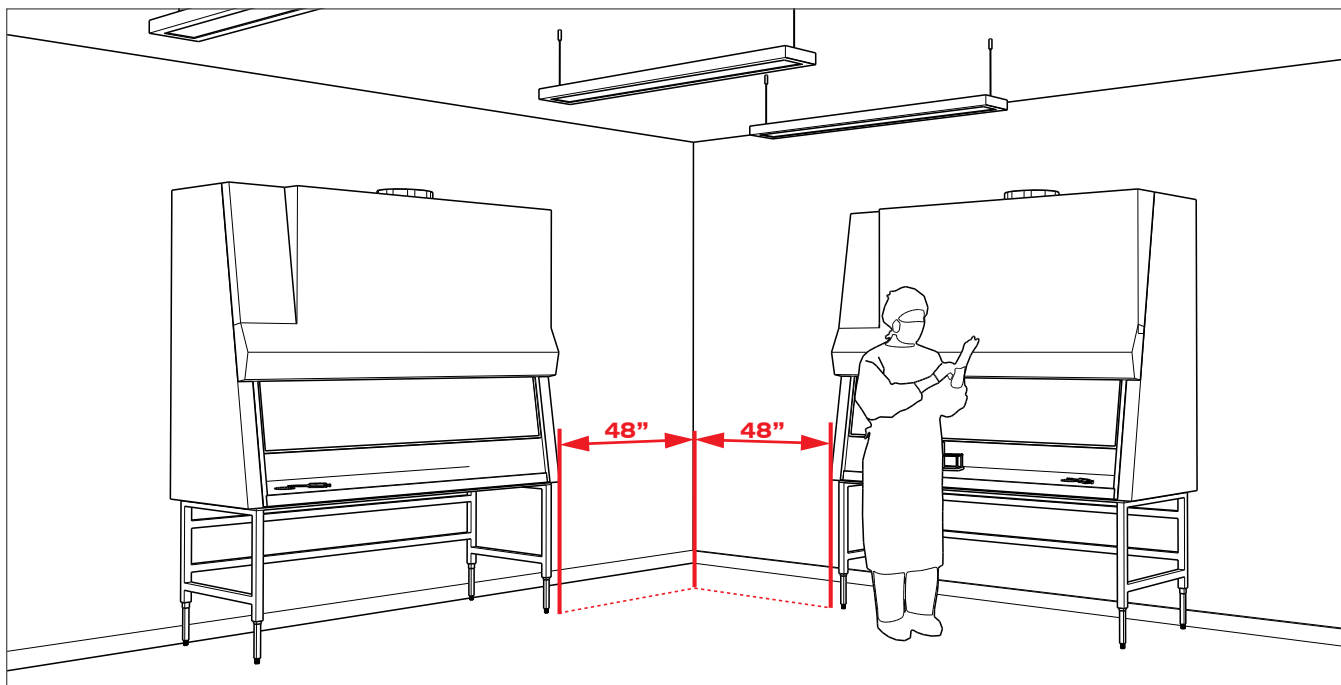

Maintain a distance of 48" between BSCs along perpendicular walls.

### BSC Placement Near Doorways:

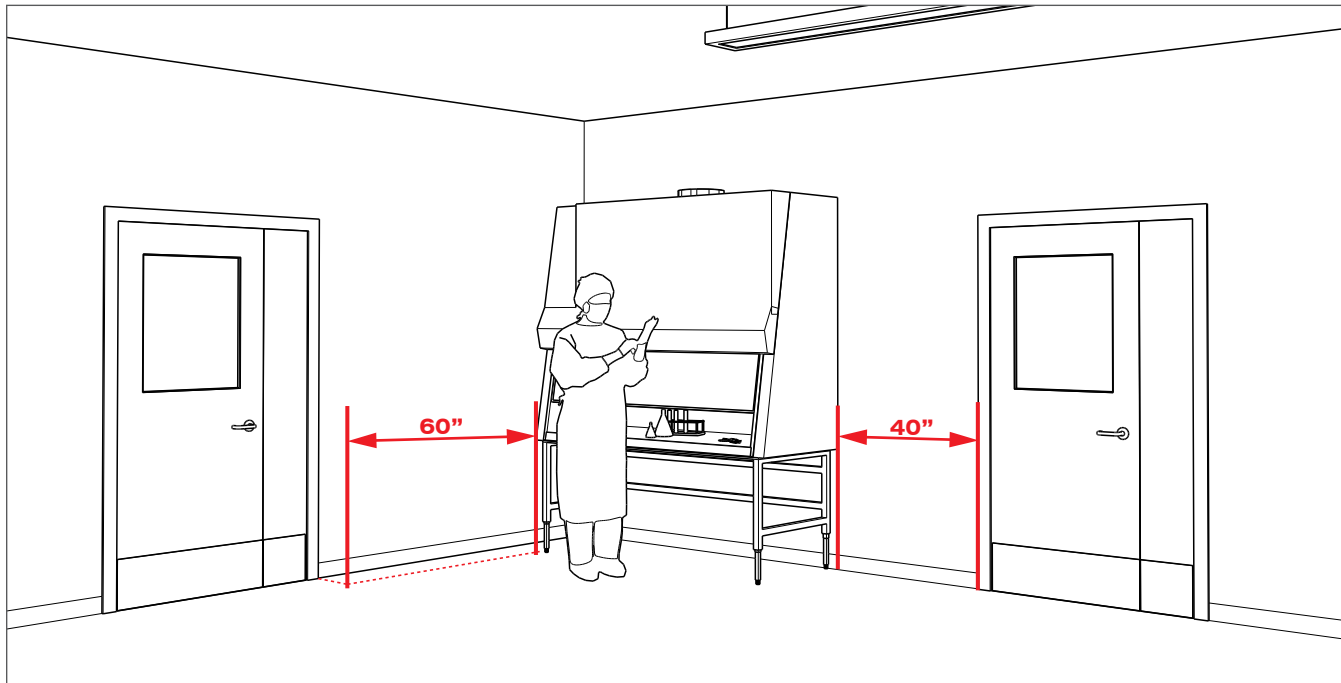

Placing BSCs near doorways is not recommended. If this arrangement is absolutely necessary maintain a distance of 40" to adjacent doorways and 60" to doorways behind the BSC.

### BSC & Bench Placement:



Do not crowd bench tops and BSCs. Too much traffic produces dangerous disturbances to BSC airflow.



### BSC Distance from Entry:

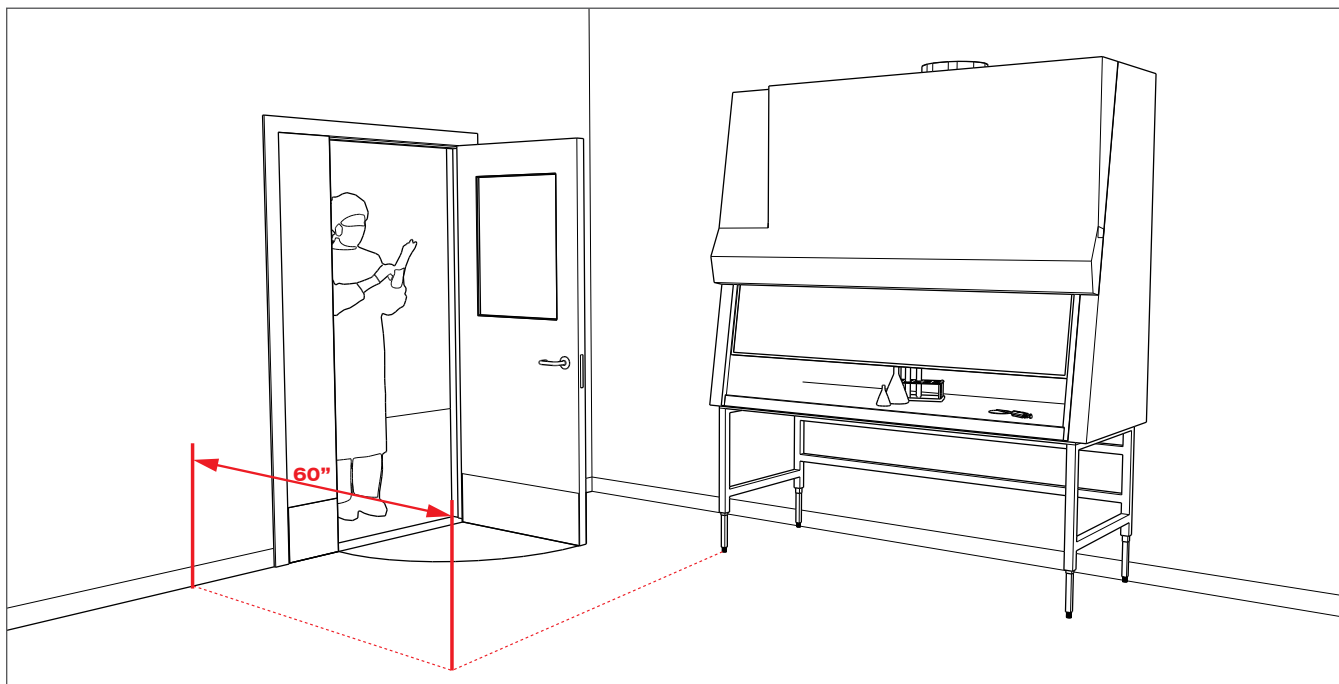

Maintain a distance of at least 60" from entry into lab modules to BSC.

# Appendix B

## Downdraft Table Particle Capture Efficiency Calculation

---

**Farhad Memarzadeh, Ph.D., P.E.**

Division of Technical Resources

Office of Research Facilities

National Institutes of Health

To calculate capture efficiency of a downdraft table, the presented method used a particle tracking model with some assumptions on the flow field.



**Assumptions:**

1. Flow around the table: uniform, but not necessarily vertical, horizontal velocity components of the airflow can be considered. No pressure gradient in the flow field.
2. Particles can have no-zero initial velocity.
3. Particles will not collide with each other.

## Particle Movement Calculation

Force that are exerted on a moving particle:

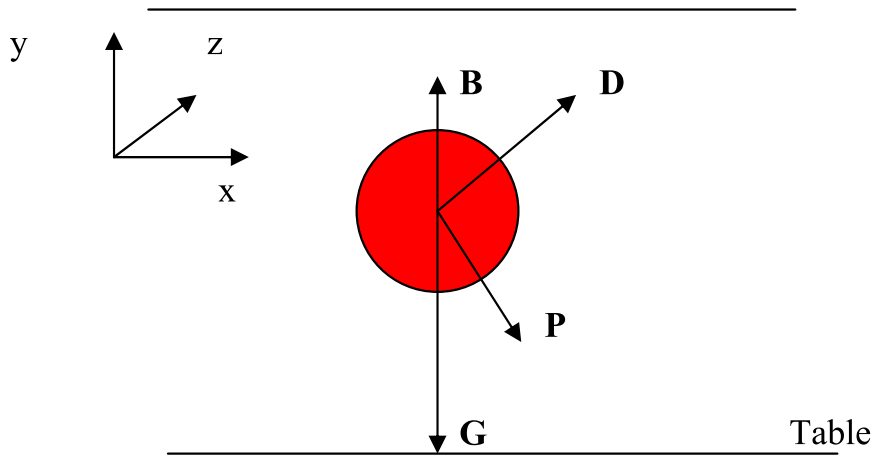

**G:** Gravity force

**B:** Buoyancy force

**D:** Drag Force

**P:** Pressure Force (caused by the pressure gradient in the flow field).

Neglected forces are: Additional inertia force, Basset Force, Magnus Force, Saffman Forces, Lift force.

Particle Motion Equation:

$$\sum \mathbf{F} = m\mathbf{a} = \mathbf{G} + \mathbf{B} + \mathbf{D} + \mathbf{P}$$

$$m\mathbf{a} = \frac{1}{6}\pi d^3 \rho_p \frac{d\mathbf{u}_p}{dt}$$

$$\mathbf{G} = \rho_p \mathbf{g}V$$

$$\mathbf{B} = \rho_g \mathbf{g}V$$

$$\mathbf{D} = \frac{1}{8}\pi C_D d^2 \rho_g |\mathbf{u}_g - \mathbf{u}_p| (\mathbf{u}_g - \mathbf{u}_p)$$

$$\mathbf{P} = 0$$

$C_D$  can be calculated by either Clift and Gauvin's formula or Putnam's formula:

*Clift and Gauvin's formula*

$$C_D = f \frac{24}{\text{Re}}$$

$$f = 1 + 0.15\text{Re}_r^{0.687} + 0.0175 \frac{\text{Re}_r}{1 + 42500\text{Re}_r^{-1.16}}$$

Putnum's formula

$$C_D = f \frac{24}{\text{Re}_r}$$

$$f = 1 + \frac{1}{6}\text{Re}_r^{2/3}$$

Where  $\text{Re}_r$  is the Reynolds number based on relative velocity

$$\text{Re}_r = \frac{\rho_g |\mathbf{u}_g - \mathbf{u}_p| d}{\mu}$$

When expressed in three directions form, the formula becomes

$$\mathbf{X}: \frac{du_{px}}{dt} = \frac{3C_D\rho_g}{4d\rho_p} \sqrt{(u_{gx} - u_{px})^2 + (u_{gy} - u_{py})^2 + (u_{gz} - u_{pz})^2} (u_{gx} - u_{px})$$

$$\mathbf{Y}: \frac{du_{py}}{dt} = \frac{\rho_p - \rho_g}{\rho_p} g + \frac{3C_D\rho_g}{4d\rho_p} \sqrt{(u_{gx} - u_{px})^2 + (u_{gy} - u_{py})^2 + (u_{gz} - u_{pz})^2} (u_{gy} - u_{py})$$

$$\mathbf{Z}: \frac{du_{pz}}{dt} = \frac{3C_D\rho_g}{4d\rho_p} \sqrt{(u_{gx} - u_{px})^2 + (u_{gy} - u_{py})^2 + (u_{gz} - u_{pz})^2} (u_{gz} - u_{pz})$$

## Numerical Solution

Simple explicit first order differencing scheme:

Use  $\frac{d\mathbf{u}_p}{dt} = \frac{\mathbf{u}_p^{n+1} - \mathbf{u}_p^n}{\Delta t}$  and get:

$$u_{px}^{n+1} = \Delta t \left\{ u_{px}^n + \frac{3C_D\rho_g}{4d\rho_p} \sqrt{(u_{gx} - u_{px}^n)^2 + (u_{gy} - u_{py}^n)^2 + (u_{gz} - u_{pz}^n)^2} (u_{gx} - u_{px}^n) \right\}$$

$$u_{py}^{n+1} = \Delta t \left\{ u_{py}^n - \frac{\rho_p - \rho_g}{\rho_p} g + \frac{3C_D\rho_g}{4d\rho_p} \sqrt{(u_{gx} - u_{px}^n)^2 + (u_{gy} - u_{py}^n)^2 + (u_{gz} - u_{pz}^n)^2} (u_{gy} - u_{py}^n) \right\}$$

$$u_{pz}^{n+1} = \Delta t \left\{ u_{pz}^n + \frac{3C_D\rho_g}{4d\rho_p} \sqrt{(u_{gx} - u_{px}^n)^2 + (u_{gy} - u_{py}^n)^2 + (u_{gz} - u_{pz}^n)^2} (u_{gz} - u_{pz}^n) \right\}$$

This method requires relatively small time steps to keep the solution stable, currently 0.0001s is found sufficient.

## Capture Efficiency Calculation

Capture efficiency (percentage) can be easily obtained by calculating a single particle's drift distance in horizontal directions. For example, if a particle is released from  $X_0, Y_0, Z_0$  in space, we just need to calculate how much distance the particle has drifted from  $X_0, Z_0$ , given the fixed vertical falling height. Assume the trajectory of the particle cross  $(X_0 - X_d, 0, Z_0 - Z_d)$ , then the capture percentage is simply

$$C = \frac{L - X_d}{L} \frac{W - Z_d}{W} \times 100\%$$

where L and W are length and width of the draft table.

In the spreadsheet, the ranges of particle releasing and landing are represented by two rectangles.



## Nomenclature

**G**: Gravity force vector

**B**: Buoyancy force vector

**D**: Drag Force vector

**P**: Pressure Force (caused by the pressure gradient in the flow field) vector

**a**: Acceleration of particle vector

**m**: Mass of particle

**V**: Volume of particle

**d**: Particle diameter

$\rho_p$ : Density of particle

$\rho_g$ : Density of Gas (air)

$C_D$ : Drag coefficient of particle

**f**: Resistance factor

$Re_r$ : Reynolds number based on relative speed

$\mathbf{u}_g$ : Gas velocity vector ( $u_{gx}, u_{gy}, u_{gz}$  are velocity components in x,y,z directions)

$\mathbf{u}_p$ : Particle velocity vector

$\mathbf{u}_p^{n+1}$ : Particle velocity vector in the new time step

$\Delta t$ : Time step

**L**: Length of the downdraft table (center area where the flow is drawing downwards)

**W**: Width of the downdraft table (center area where the flow is drawing downwards)

$X_0, Y_0, Z_0$ : Release location of particle

$X_d, Z_d$ : Drift distance in X, Z directions.

**C**: Capture efficiency

### User Input

Table Dimension		
Length X		24 in
Width Z		24 in

Airflow Condition around Table		
Air Density		1.1614 kg/m <sup>3</sup>
Air Viscosity		1.84E-05 Ns/m <sup>2</sup>
<b>Vertical Speed Vy</b>		<b>-50 ft/min</b>
Horizontal Speed Vx		15 ft/min
Horizontal Speed Vz		15 ft/min



Particle Information		
Size		5 micron
Density		1000 kg/m <sup>3</sup>
<b>Release Height</b>		<b>5 in</b>
Particle Initial Velocity		
Vertical Speed Vy		0 ft/min
Horizontal Speed Vx		0 ft/min
Horizontal Speed Vz		0 ft/min

### Output

Drift Length X		1.50 in
Drift Length Z		1.50 in
Drift Length		2.12 in
<b>Capture Percentage</b>		<b>87.92 %</b>

	Release Range		Landing Range	
	X	Z	X	Z
Corner 1	0	0	1.50	1.50
Corner 2	24	0	25.50	1.50
Corner 3	24	24	25.50	25.50
Corner 4	0	24	1.50	25.50
Corner 1	0	0	1.50	1.50

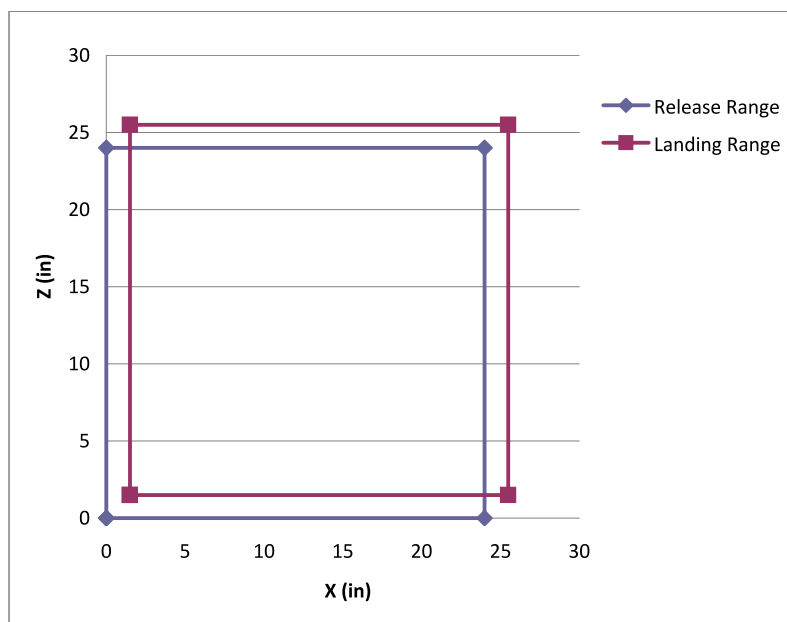

### User Input

Table Dimension	
Length X	24 in
Width Z	24 in

Airflow Condition around Table	
Air Density	1.1614 kg/m <sup>3</sup>
Air Viscosity	1.84E-05 Ns/m <sup>2</sup>
<b>Vertical Speed Vy</b>	<b>-100 ft/min</b>
Horizontal Speed Vx	15 ft/min
Horizontal Speed Vz	15 ft/min



Particle Information	
Size	5 micron
Density	1000 kg/m <sup>3</sup>
<b>Release Height</b>	<b>5 in</b>
Particle Initial Velocity	
Vertical Speed Vy	0 ft/min
Horizontal Speed Vx	0 ft/min
Horizontal Speed Vz	0 ft/min

### Output

Drift Length X	0.75 in
Drift Length Z	0.75 in
Drift Length	1.06 in
<b>Capture Percentage</b>	<b>93.85 %</b>

	Release Range		Landing Range	
	X	Z	X	Z
Corner 1	0	0	0.75	0.75
Corner 2	24	0	24.75	0.75
Corner 3	24	24	24.75	24.75
Corner 4	0	24	0.75	24.75
Corner 1	0	0	0.75	0.75

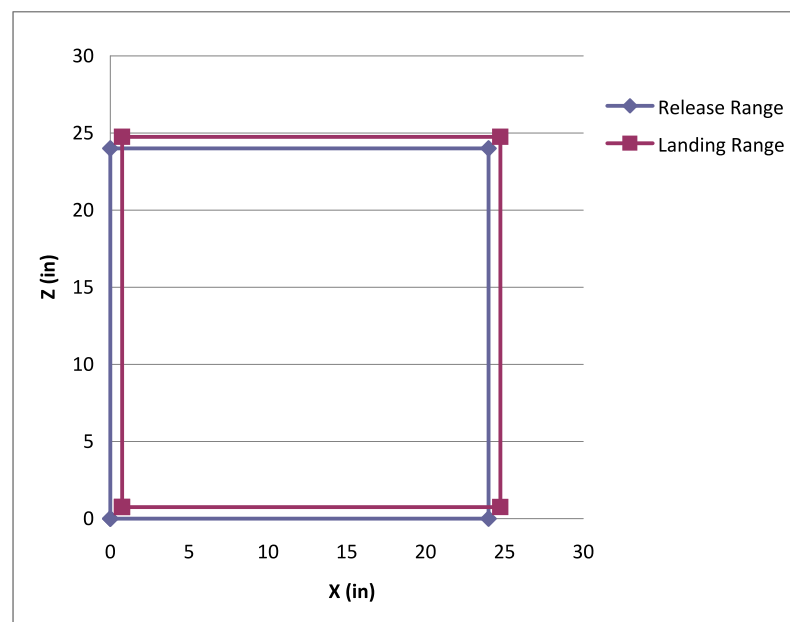

# Appendix C

## BAS for Bethesda Campus and Satellite Sites

---

## BAS Application

**A. Introduction:** Appendix C presents clarification of specific applications of [Chapter 7: Building Automation Systems](#) as applied to the Bethesda Campus of NIH as well as Poolesville and Rocky Mountain Laboratories campuses/sites which are managed from the Bethesda Campus.

**B. General Requirements:** Consult with the designated representative from Division of Design and Construction Management for requirements for using the campus network, alarming integration with the IT Help Desk, and when applicable, integration to existing systems. Coordinate with the Division of Facilities, Operations, and Maintenance (DFOM), Accreditation Services Branch (ASB) relative to Animal Research Facilities (ARFs) Environmental Monitoring and Data storage.

**C. Scope:** Utilities at the Bethesda Campus are provided from a central utility plant. Coordinate with the Division of Technical Resources (DTR), Utilities Distribution Branch (UDB) and DFOM, Maryland Facilities Management Branch (MFMB) for building utilities monitoring. Electrical power, chilled water, and steam, shall be connected to independent monitoring systems (Supervisory Control and Data Acquisition (SCADA) for electrical and Utility Monitoring System). Some devices (e.g., flow meters) may be tied into both systems.

**D. Standardization:** The following site-specific standards apply to the Bethesda Campus. These are available at:

- Alarm handling procedures specification
- NIH Point Naming
- Supervised Objects Specification
- NIH Specific Requirements
- Central Archiving Software
- Remote Alarming Notification

**E. General Infrastructure Requirements:** BAS installed on the Bethesda Campus shall use the existing FACNet Ethernet LAN installed by Center for Information Technology (CIT). This network shall support other systems such as security, ARF's Environmental Monitoring, Data, etc. IP addresses of primary panels shall be assigned by CIT.

BAS installed at satellite sites shall use the same network with remote connection as configured by CIT.

### Continuous Monitoring Requirements

#### MANAGING AND TRACKING THE SECURITY STATE OF INFORMATION SYSTEMS

A critical aspect of managing risk to information from the operation and use of information systems involves the continuous monitoring of the security controls employed within or inherited by the system. Conducting a thorough point-in-time assessment of the deployed security controls is a necessary but not sufficient condition to demonstrate security due diligence. An effective organizational information security program also includes a rigorous continuous monitoring program integrated into the system development life cycle. The objective of the continuous monitoring program is to determine if the set of deployed security controls continue to be effective over time in light of the inevitable changes that occur. Continuous monitoring is a proven technique to address the security impacts on an information system resulting from changes to the hardware, software, firmware, or operational environment. A well designed and well managed continuous monitoring program can effectively transform an otherwise static security control assessment and risk determination process into a dynamic process that provides essential, near real-time security status-related information to organizational officials in order to take appropriate risk mitigation actions and make cost-effective, risk-based decisions regarding the operation of the information system. Continuous monitoring programs provide organizations with an effective mechanism to update security plans, security assessment reports, and plans of action and milestones.

#### Solicitation provisions:

**A. Solicitation:** The IT Security provisions found in NIH IT SECURITY – FACnet SOLICITATION PROVISION, should be added to any new IT solicitation.

1. **Integration With Existing Systems:** Existing systems at Bethesda are predominantly the Siemens Building Technologies Apogee System and Johnson Controls Inc. Metasys Extended Architecture.

- a. **Primary Controller LAN:** Illustrative examples of a Primary Controller LAN include Siemens BLN or JCI N1.
- b. **Secondary Controller LAN:** Illustrative examples of a Secondary Controller LAN include Siemens FLN or JCI N2.

## 2. Servers:

- a. **Description:** Server infrastructures that exist at the Bethesda Campus include Siemens Apogee and JCI Metasys. New systems that extend the coverage of these existing systems shall include applicable upgrades to the server environment required to support the new extension.
3. **Vivarium Monitoring Workstations:** Coordinate with DFOM ASB for required computers (typically not required), BAS and Data LAN connections, and trend/point requirements for all ARFs installed at the Bethesda Campus or satellite facilities.
4. **Intranet Remote Connections:** Coordinate with CIT for LAN configurations and access rights for remote access.

**B. Building Level Requirements:** Coordinate with UEB for building utilities monitoring. Much of the monitoring required here shall be tied into the NIH Campus Energy Management System. In some cases, devices like flow meters can be tied into both the campus wide energy management system as well as the BAS.

1. **Laboratories with VAV Hoods:** All new installations of VAV fume hoods shall incorporate high speed electronic actuators on the fume hood exhaust control box as well as all associated airflow/pressure tracking controls.
2. **Critical Laboratories:** There shall not be fireman's override controls on non-Joint Commission systems at Bethesda or satellite sites.
3. **All Animal Holding Rooms:** Space and humidity sensors in Bethesda and satellite sites shall be located in the general exhaust stream as close as practical to a representative room inlet. Ensure sensor penetrations into duct are well sealed and

that the sensor is representative of the macro-environment of the animal holding room.

4. **Supply Air Systems:** Supply air systems that do not serve Joint Commission accredited spaces shall not include smoke or heat detection and corresponding shutdown that would be required by the National Fire Protection Association (NFPA).
5. **Scheduling:** Laboratory spaces shall not include scheduled variations to temperature or airflow.
6. **Building Steam Connections to Campus System:** The steam to buildings on the Bethesda Campus shall come from the campus steam system and immediately be reduced in pressure. Coordinate with UEB for the meters and monitoring of the steam service.
7. **Campus Chilled Water Connections:** The chilled water to buildings at the Bethesda Campus shall come from the campus chilled water system. The design shall include building pumps, a decoupling bridge, and a building valve. Coordinate with UEB for projections as to the extremes of potential pressure differentials probable at the building and provide a valve selected for effective control across that range of pressure differentials.
8. **Control Air Systems:** The campus air system shall be used as the primary source for control air. Redundant local compressors shall provide the required airflow if the campus air system fails.
9. **Fume Hoods:** Two systems that have been qualified for use at NIH include Siemens Building Technologies FHC and associated LRC, and Phoenix Celaris.

**C. Control System Architecture:** One master architecture diagram shall be maintained for each installed manufacturer that is inclusive of all installations of that system on campus. Design documents shall include the requirement to update this.

1. **Points List:** One master points list shall be maintained for each installed manufacturer that is inclusive of all installations of that system on campus. If this can be queried from the BAS server database, this will suffice.



2. **Primary Controller:** The following are examples of Primary Controllers at Bethesda and satellites:

- SBT Modular Building Controller or Modular Equipment Controller with expander modules allowed. The key requirement is for the MBC or MEC processor to fully control all sequences of points attached to it.
- JCI packaged NAE with a dedicated DX 9100 and no other devices on the N2

3. **Secondary Controllers: Examples** of secondary controllers at the Bethesda and satellite campuses include:

- SBT TEC, RPC, LRC, DPMs, DEMs
- JCI UNT, DX9100, DX9200, VMA, AHU, LN Series

4. **Flow Meters:** All incoming building utilities metered values shall be displayed on both the general building graphics used by operating personnel, and the energy management graphics. All incoming supply domestic water, chilled water and steam metered values, as well as chilled water supply and return temperature and pressure values shall also be mapped to and be functional with BAS historical utility database. The following shall apply to the Bethesda Campus. Electric metering requirements will be covered in [Chapter 10: Electrical Design](#).

- Steam metering shall be insertion vortex shedding devices. Turbine meters shall be considered only in extreme cases, or as additional supplemental devices to capture minimum flow in extreme cases.
- Chilled water shall be clamp on ultrasonic devices.
- Domestic water shall be magnetic metering devices. Clamp on ultrasonic devices for line sizes in excess of 150 mm (6 in) can be considered.

5. **Actuators:** New installations at Bethesda and satellite campuses shall use electronic actuators unless specifically directed otherwise by the Project Officer (PO). This shall include both slow acting (30 sec and above) and fast acting (< 2 sec). One exception to this is for high

torque actuators on main supply air handling units and exhaust fans that serve containment applications.

6. **Compressed Air Systems:** Campus compressed air shall be distributed to the building from the campus system on the Bethesda campus. Tie in to the building standby skid shall be downstream of the compressors and receiver and upstream of driers and filters. Ensure, standby compressors are adequately exercised.

#### **NIH IT Security – FACnet Solicitation Provision**

Include the following requirement in the Statement of Work (SOW) for any new FACnet systems that include hardware, software, services and service renewals. This requirement applies to any locations with NIH presence — including remote locations, research laboratories or NIH leased facilities.

Information Security is applicable to this solicitation and the following information is provided to assist in proposal preparation.

**IMPORTANT NOTE TO OFFERORS:** The following information shall be addressed in a separate section of the Technical Proposal entitled, “INFORMATION SECURITY.”

The Federal Information Security Management Act of 2002 (P.L. 107-347) (FISMA) requires each agency to develop, document, and implement an agency-wide information security program to safeguard information and information systems that support the operations and assets of the agency, including those provided or managed by another agency, contractor (including subcontractor), or other source. The National Institute of Standards and Technology (NIST) has issued a number of publications that provide guidance in the establishment of minimum security controls for management, operational and technical safeguards needed to protect the confidentiality, integrity and availability of a Federal information system and its information.

The SOW requires the successful offeror to perform one, or any combination, of the following:

1. Develop, have the ability to access or host and/or maintain a Federal information system(s).

2. Access to or use of Personally Identifiable Information (PII), including instances involving remote access to or physical removal of such information beyond agency premises or control.

Pursuant to Federal and HHS Information Security Program Policies the following requirements apply to this solicitation:

Federal Information Security Management Act of 2002 (FISMA), Title III, E-Government Act of 2002, Pub. L. No. 107-347 (Dec. 17, 2002)

### **NIH Physical Access Security – Solicitation Provision**

Physical Access Security is applicable to this solicitation and the following information is provided to assist in proposal preparation.

**IMPORTANT NOTE TO OFFERORS:** The following information shall be addressed in a separate section of the Technical Proposal entitled, “PHYSICAL ACCESS SECURITY.”

In accordance with OMB Memorandum M-05-24, background investigations must be completed for all contractor/subcontractor personnel who have (1) access to sensitive information, (2) access to Federal information systems, (3) regular or prolonged physical access to Federally-controlled facilities, or (4) any combination thereof. [Reference: Definition of “Federally-controlled facilities” at Federal Acquisition Regulation (FAR) Subpart 2.1, *Definitions*]

The SOW requires the successful offeror to have regular or prolonged physical access to a Federally-controlled facility, thereby requiring compliance with the following regulations/policies:

- HHS Information Security Program Policy
- Homeland Security Presidential Directive/HSPD-12, *Policy for a Common Identification Standard for Federal Employees and Contractors* (08-27-04)
- OMB Memorandum M-05-24, *Implementation of Homeland Security Presidential Directive (HSPD) 12 – Policy for a Common Identification Standard for Federal Employees and Contractors* (08-05-05)

- Federal Information Processing Standards Publication (FIPS PUB) 201-1 (Updated June 26, 2006)
- HHS Interim Policy: *Contractual Implementation of Homeland Security Presidential Directive (HSPD) 12, Policy for a Common Identification Standard for Federal Employees and Contractors* [Draft]
- HHS Office of Security and Drug Testing, Personnel Security/Suitability Handbook (02-01-05)

#### **A. Information Type**

Administrative, Management and Support Information:

#### **B. Security Categories and Levels**

Confidentiality Level:

- Low
- Moderate
- High

Integrity Level:

- Low
- Moderate
- High

Availability Level:

- Low
- Moderate
- High

Overall Level:

- Low
- Moderate
- High

#### **C. Position Sensitivity Designations**

Prior to award, the Government will determine the position sensitivity designation for each contractor (including subcontractor) employee that the successful offeror proposes for work under the acquisition. For proposal preparation purposes, the following designations apply:

- Level 6: Public Trust – High Risk** (Requires Suitability Determination with a BI). Contractor/

subcontractor employees assigned to a Level 6 position are subject to a Background Investigation (BI).

- Level 5: Public Trust – Moderate Risk** (Requires Suitability Determination with NACIC, MBI or BI). Contractor/subcontractor employees assigned to a Level 5 position with no previous investigation and approval shall undergo a National Agency Check and Inquiry Investigation plus a Credit Check (NACIC), a Minimum Background Investigation (MBI), or a Limited Background Investigation (LBI).
- Level 1: Non-Sensitive** (Requires Suitability Determination with an NACI). Contractor/subcontractor employees assigned to a Level 1 position are subject to a National Agency Check and Inquiry Investigation (NACI).

Upon award, the contractor will be required to submit a roster by name, position, e-mail address, phone number and responsibility, of all staff (including subcontractor staff) working under the acquisition who will develop, have the ability to access, or host and/or maintain a federal information system(s). The Government will determine and notify the Contractor of the appropriate level of suitability investigation required for each staff member.

Upon receipt of the Government’s notification of applicable Suitability Investigations required, the contractor shall complete and submit the required forms within 30 days of the notification.

Contractor/subcontractor employees who have met investigative requirements within the past five years may only require an updated or upgraded investigation.

Contractor/subcontractor employees shall be required to comply with the HHS criteria for the assigned position sensitivity designations prior to performing any work under the acquisition. The following exceptions apply:

- **Levels 5 and 1:** Contractor/subcontractor employees may begin work under the acquisition after the contractor has submitted the name, position and responsibility of the employee to the PO.
- **Level 6:** In special circumstances the PO may request a waiver of the pre-appointment investigation. If

the waiver is granted, the PO will provide written authorization for the contractor/subcontractor employee to work under the acquisition.

#### **D. Information Security Training**

HHS policy requires contractors/subcontractors receive security training commensurate with their responsibilities for performing work under the terms and conditions of their contractual agreements.

The successful offeror will be responsible for assuring that each contractor/subcontractor employee has completed the NIH Computer Security Awareness Training course or an equivalent training course specified by NIH prior to performing any work under the acquisition, and thereafter completing the NIH-specified fiscal year refresher course during the period of performance of the acquisition. The successful offeror will be responsible for maintaining a listing of all individuals who have completed this training and submitting this listing to the PO.

Additional security training requirements commensurate with the position may be required as defined in NIST Special Publication 800-16, Information Technology Security Training Requirements. This document provides information about information security training that may be useful to potential offerors.

#### **E. Rules of Behavior**

The successful offeror’s employees and subcontractor employees shall be required to comply with the NIH Information Technology General Rules of Behavior.

#### **F. Personnel Security Responsibilities**

The successful offeror shall be required to perform and document the following actions:

##### **Contractor Notification of New and Departing Employees Requiring Background Investigations**

**A.** The contractor shall notify the Contracting Officer (CO), the PO, and the Security Investigation Reviewer within **five working days** before a new employee assumes a position that requires a suitability determination or when an employee with a security clearance stops working under this acquisition. The government will initiate a background investigation on new employees requiring security clearances and will stop pending background

investigations for employees that no longer work under this acquisition.

**B. New Employees:** Provide the name, position title, e-mail address, and phone number of the new employee. Provide the name, position title and suitability level held by the former incumbent. If the employee is filling a new position, provide a description of the position and the government will determine the appropriate security level.

**C. Departing Employees:**

- Provide the name, position title, and security clearance level held by or pending for the individual.
- Perform and document the actions identified in the “Contractor Employee Separation Checklist”, of this acquisition, when a contractor/subcontractor employee terminates work under this acquisition. All documentation shall be made available to the PO and/or CO upon request.

**D. Commitment to Protect Non-Public Departmental Information Systems and Data**

1. **Contractor Agreement:** The successful offeror and its subcontractors performing under this SOW shall be required not to release, publish, or disclose non-public departmental information to unauthorized personnel, and shall protect such information in accordance with provisions of the following laws and any other pertinent laws and regulations governing the confidentiality of such information:
  - 18 U.S.C. 641 (Criminal Code: Public Money, Property or Records)
  - 18 U.S.C. 1905 (Criminal Code: Disclosure of Confidential Information)
  - Public Law 96-511 (Paperwork Reduction Act)
2. **Contractor Employee Non-Disclosure Agreement:** Each contractor/subcontractor employee who may have access to non-public department information under the acquisition shall be required to complete the Commitment to Protect Non-Public Information – Contractor Employee Agreement. A copy of each signed

and witnessed Non-Disclosure agreement shall be submitted to the PO prior to performing any work under the acquisition.

**E. Offeror’s Official Responsible for Information Security**

The offeror must include in the “Information Security” part of its Technical Proposal the name and title of its official who will be responsible for all information security requirements should the offeror be selected for an award.

**F. NIST SP 800-53 Self-Assessment**

If the offeror proposes to (1) develop a federal information system at the contractor’s/subcontractor’s facility or (2) host or maintain a federal information system at the contractor’s/subcontractor’s facility, they must include in the “Information Security” part of its Technical Proposal, a completed Self-Assessment required by NIST SP 800-53, *Recommended Security Controls for Federal Information Systems*. NIST 800-53 assesses information security assurance of the offeror’s internal systems security. This assessment is based on the Federal IT Security Assessment Framework and NIST SP 800-53 at:

- **NIST SP 800-53, Rev. 4**
- **Annex 1:** Baseline Security Controls for Low-Impact Information Systems
- **Annex 2:** Baseline Security Controls for Moderate-Impact Information Systems
- **Annex 3:** Baseline Security Controls for High-Impact Information Systems

**Subcontracts:** The offeror must include similar information for any proposed subcontractor that will perform under the SOW to (1) develop a federal information system(s) at the offeror’s/subcontractor’s facility, or (2) host and/or maintain a federal information system(s) at the offeror’s/subcontractor’s facility.

**G. Draft Information System Security Plan**

If the offeror proposes to (1) develop a Federal information system at the contractor’s/subcontractor’s facility or (2) host or maintain a Federal information system at the contractor’s/subcontractor’s facility, they must include a draft Information System Security Plan (ISSP) using the current template in Appendix A of NIST SP

800-18, Guide to Developing Security Plans for Federal Information Systems. The details contained in the offeror's draft ISSP must be commensurate with the size and complexity of the requirements of the SOW based on the System Categorization determined above in subparagraph (b) Security Categories and Levels.

**Subcontracts:** The offeror must include similar information for any proposed subcontractor that will perform under the SOW with the offeror whenever the submission of an ISSP is required.

**Note to Offeror:** The resultant acquisition will require the draft ISSP to be finalized in coordination with the Project Officer no later than 90 calendar days after award. Also, a contractor is required to update and resubmit its ISSP to NIH every three years following award or when a major modification has been made to its internal system.

#### **H. Prospective Offeror Non-Disclosure Agreement**

The Government has determined that prospective offerors will require access to sensitive federal information described below in order to prepare an offer.

Any individual having access to this information must possess a valid and current suitability determination at the following level:

- Level 6: Public Trust – High Risk**
- Level 5: Public Trust – Moderate Risk**

To be considered for access to sensitive federal information, a prospective offeror must:

1. Submit a written request to the CO identified in the solicitation;
2. Complete and submit the “Prospective Offeror Non-Disclosure Agreement” provided as an attachment in Section J of this solicitation; and
3. Receive written approval from the CO.

Prospective offerors are required to process their requests for access, receive Government approval, and then access the sensitive Federal information within the period of time provided in the solicitation for the preparation of offers.

Nothing in this provision shall be construed, in any manner, by a prospective offeror as an extension to the stated date, time, and location in the solicitation for the submission of offers.

#### **I. Personally Identifiable Information (PII) Security Plan**

The offeror must include a draft PII Security Plan that addresses each of the following items relative to protecting the PII that the SOW allows the contractor/subcontractor to remotely access or physically remove from the agency's premises or control:

1. Verify the information categorization to ensure the identification of the PII requiring protection.
2. Verify the existing risk assessment.

Identify the offeror's existing internal corporate policy that addresses the information protection requirements of the SOW.

3. Verify the adequacy of the offeror's existing internal corporate policy that addresses the information protection requirements of the SOW.
4. Identify any revisions, or development, of an internal corporate policy to adequately address the information protection requirements of the SOW.
5. For PII to be physically transported to a remote site, verify that the security controls of NIST Special Publication 800-53 involving the encryption of transported information will be implemented.
6. For PII to be stored at a remote site, verify that the security controls of NIST Special Publication 800-53 involving the encryption of remotely stored information will be implemented.
7. When applicable, verify how the NIST Special Publication 800-53 security controls requiring authenticated, virtual private network (VPN) connections will be implemented.
8. When applicable, verify how the NIST Special Publication 800-53 security controls enforcing allowed downloading of PII will be implemented.



The details contained in the offeror’s draft PII Security Plan must be commensurate with the size and complexity of the requirements of the SOW based on the System Categorization determined above in Security Categories and Levels.

**Subcontracts:** The offeror must include similar information for any proposed subcontractor that will perform under the SOW with the offeror whenever the submission of a PII Security Plan is required.

#### **J. Loss and/or Disclosure of Personally Identifiable Information (PII) — Notification of Data Breach**

The successful offeror shall be responsible for reporting all incidents involving the loss and/or disclosure of PII in electronic or physical form. Notification shall be made to the NIH Chief Information Security Officer (CISO) within one hour of discovering the incident by using one of the following two forms:

- NIH PII Spillage Report
- NIH Lost or Stolen Assets Report
- The notification requirements do not distinguish between suspected and confirmed breaches.

#### **K. Encryption of Data**

The following requirements apply to all contractor/subcontractor laptop computers containing HHS data at rest and/or HHS data in transit.

1. All laptop computers shall be secured using a Federal Information Processing Standard (FIPS) 140-2 compliant whole-disk encryption solution. The cryptographic module used by an encryption or other cryptographic product shall be tested and validated under the Cryptographic Module Validation Program to confirm compliance with the requirements of FIPS PUB 140-2 (as amended).
2. All data at rest and in transit, unless the data is determined to be non-sensitive in writing by the NIH CIO or his/her designee, shall be encrypted using a FIPS 140-2 compliant product. Data at rest includes all HHS data regardless of where it is stored.
3. A FIPS 140-2 compliant key recovery mechanism shall be used so that encrypted information can be decrypted and accessed by

authorized personnel. Use of encryption keys which are not recoverable by authorized personnel is prohibited. Key recovery is required by “*OMB Guidance to Federal Agencies on Data Availability and Encryption*”, November 26, 2001.

Encryption keys shall comply with all HHS and NIH policies and shall provide adequate protection to prevent unauthorized decryption of the information.

System owners shall obtain written authorization from the NIH CISO if compliance with this policy is not feasible or not technically possible, or if deviation from this policy is necessary to support a mission or business function. All policy waivers must be recorded and immediately provided to the HHS CISO.

All media used to store information shall comply with this policy until it is sanitized or destroyed in accordance with HHS policy and NIH procedures.

#### **L. Vulnerability Scanning Requirements**

If the contractor proposes hosting an NIH webpage or database, the contractor/subcontractor shall conduct periodic and special vulnerability scans, and install software/hardware patches and upgrades to protect automated federal information assets. The minimum requirement shall be to protect against vulnerabilities identified on the *SANS Top-20 Internet Security Attack Targets* list. The contractor will provide the results of these scans to the government on a monthly basis.

#### **M. Implementation of Commonly Accepted Security Configurations for Windows Operating Systems**

1. For all Information Technology provided under the acquisition, the Contractor shall certify that the applications are fully functional and operate correctly as intended on systems using the Federal Desktop Core Configuration (FDCC).
2. The standard installation, operation, maintenance, update, and/or patching of software shall not alter the configuration settings from the approved USGBC configuration. The information technology shall also use the Windows Installer Service for installation to the default



“program files” directory and shall be able to silently install and uninstall.

3. Applications designed for normal end users shall run in the standard user context without elevated system administration privileges.

#### **N. Special Information Security Requirements for Foreign Contractors/Subcontractors**

When foreign contractors/subcontractors perform work under this acquisition at non-US Federal government facilities, provisions of HSPD-12 do NOT apply.

#### **O. Control Systems Requirements**

When a purchase or acquisition includes control systems the procurement security requirement language shall include the appropriate language from the DHS Cyber Security Procurement Language for Control Systems (CSPLCS). Control systems include but are not limited to Supervisory Control and Data Acquisition (SCADA), Process Control Systems (PCS), Distributed Control Systems (DCS), Industrial Control Systems (ICS) and related equipment types. Appropriate language includes the Procurement Language for the DHS CSPLCS sections identified in the baseline requirements listed below plus any section which corresponds to functionality present in the target control system or control system component.

Baseline requirement sections:

- 2.1 Removal of Unnecessary Services and Programs
- 2.3 Changes to File System and Operating System Permissions
- 2.4 Hardware Configuration
- 2.6 Installing Operating Systems, Applications, and Third-Party Software Updates
- 4.1 Disabling, Removing, or Modifying Well-Known or Guest Accounts
- 4.2 Session Management
- 4.3 Password/Authentication Policy and Management
- 4.4 Account Auditing and Logging
- 4.5 Role-Based Access Control for Control System Applications
- 4.6 Single Sign-On

- 5.1 Coding for Security
- 6.1 Notification and Documentation from Vendor
- 6.2 Problem Reporting

#### **P. References: Information Security including Personally Identifiable Information**

1. Federal Information Security Management Act of 2002 (FISMA), Title III, E-Government Act of 2002, Pub. L. No. 107-347 (Dec. 17, 2002)
2. NIH Computer Security Awareness Training Course
3. NIST Special Publication 800-16, Information Technology Security Training Requirements
4. NIST SP 800-18, Guide for Developing Security Plans for Information Technology Systems
5. NIST SP 800-53, Revision 3, Recommended Security Controls for Federal Information Systems
6. FIPS PUB 199, Standards for Security Categorization of Federal Information and Information Systems
7. FIPS PUB 200, Minimum Security Requirements for Federal Information and Information Systems
8. OMB Memorandum M-06-15, Safeguarding Personally Identifiable Information (05-22-06)
9. OMB Memorandum M-06-16, *Protection of Sensitive Agency Information* (06-23-06)
10. OMB Memorandum M-06-19, *Reporting Incidents Involving Personally Identifiable Information and Incorporating the Cost for Security in Agency Information Technology Investments* (07-12-06)
11. OMB Memorandum M-07-16, *Safeguarding Against and Responding to the Breach of Personally Identifiable Information* (05-22-07)
12. *Guide for Identifying Sensitive Information, including Information in Identifiable Form, at the NIH* (Draft: 10-04-06) (Available from the ISSO)
13. HHS OCIO Policies

**Q. References: Physical Access Security**

1. HHS Information Security Program Policy
2. OMB Memorandum M-05-24, Implementation of Homeland Security Presidential Directive (HSPD) 12 – *Policy for a Common Identification Standard for Federal Employees and Contractors* (08-05-05)
3. Federal Information Processing Standards Publication (FIPS PUB) 201-1 (Updated June 26, 2006)
4. HHS Interim Policy: *Contractual Implementation of Homeland Security Presidential Directive (HSPD) 12, Policy for a Common Identification Standard for Federal Employees and Contractors* [Draft]
5. Federal Acquisition Regulation (FAR) 37.602, Performance Work Statement (PWS)
6. FAR Subpart 4.13, Personal Identity Verification of Contractor Personnel
7. FAR 52.204-9, Personal Identity Verification of Contractor Personnel [clause]

# Appendix D

## HVAC

---

### References

Murphy, Howard G., "Power Quality Issues with Adjustable Frequency Drive - Coping with Power Loss and Voltage Transients," *Iron and Steel Engineer*, February 1994.

Turkel, Solomon S., "Understanding Variable Speed Drives (parts 1 to 6)," *Electrical Construction and Maintenance*, February to July 1995.

### A. Calculating the Ventilation Rate for the Removal of Contaminants from Biomedical Laboratories by Farhad Memarzadeh, Ph.D., P.E., of the National Institutes of Health

Consultants that address the indoor air quality using the dilution method must fully understand the shortcomings. Containment is preferred over dilution where practical. When dilution is used, concentration levels can vary greatly depending on air flow patterns within a room and the nature of the source or the contaminant. Contaminant is never evenly distributed within a room. The following equation is based evenly distribution. So, if used consideration shall be given to the fact that the results are only the average when supply air is mixing evenly with the contaminant. In practice, most areas within a room will have higher or lower concentrations.

Where:

$C = C_0 e^{-[V_{\text{removed}} / V_{\text{room}}]}$  = the Ending Concentration of the Vapor in the Closed Space or Room, which Ending Concentration, measured in ppm, resulted from the purging activities:

$C_0$  = the Initial Concentration of the Vapor in the Closed Space or Room that is to be reduced by purging, also measured in ppm;

$V_{\text{removed}}$  = the Air Volume that has been withdrawn from the Closed Space or Room, measured in any suitable volumetric units, usually in cubic feet (ft); and

$V_{\text{room}}$  = the Volume of the Room, measured in the same volumetric units as  $V_{\text{removed}}$ , which is usually in cubic feet (ft<sup>3</sup>).

A real example of the use of the above equation would be if a consultant needs to assess the Aroom volumes≈ of air that must be withdrawn from (purged) a room in order to reduce the concentration of any volatile substance in the ambient air of that room by 90% or by 99%. In order to achieve some well defined and specific decrease in the Astarting ambient concentration≈ of some unidentified volatile substance. From the perspective of the applicable formula listed above, we must view this as asking for a value of An≈, where An≈ is the number of Room Volumes for which – once this volume of ambient, volatile filled air had been removed from the space – would result in a situation where the residual room concentration of that volatile would be at or below the identified target concentration level.

Specifically, seeking an exponent of Ae≈ in the following general format:

$$- \frac{n V_{\text{room}}}{V_{\text{room}}}$$

Clearly, the  $AV_{\text{room}} \approx$  terms will cancel out, and we are left with the simple exponent value of n; and we can, therefore, see that formula evolves to the following:

$$C = C_0 e^{-n \frac{V_{\text{room}}}{V_{\text{room}}}} = C_0 e^{-n}$$

The task for the consultant is simply to determine the value of n, as a number of Room Volumes, that corresponds to: (1) a decrease in the ambient concentration to a level that is only 10% of the starting value (i.e., the ending concentration,  $C_{90\%}$ , has the value  $0.1C_0$ ); and (2) a decrease in the ambient concentration to a level that is only 1% of the starting value [i.e, the ending concentration,  $C_{99\%}$ , has a value,  $0.01C_0$ ].

For a 90% reduction in the concentration:

$$\ln 0.1 = -n_{90\%} = -2.303$$

$$n_{90\%} = 2.303$$

$$C_{90\%} = 0.1 C_0 = C_0 e^{-n_{90\%}}$$

$$0.1 = e^{-n_{90\%}}$$

For a 99% reduction in the concentration:

$$\ln 0.01 = -n_{99\%} = -4.605$$

$$n_{99\%} = 4.605$$

To achieve specified reductions in the ambient concentrations of any volatile substance, one must purge the following number of Room Volumes to attain the identified target reduction in the ambient room concentration level:

Target Reduction as a Percentage	Number of Room Volumes
90%	-2.3
99%	-4.6

## B. Calculating Minimum Separation Distance Between Intakes And Exhausts by Farhad Memarzadeh, Ph.D., P.E., of the National Institutes of Health

Use of an expert consultant to do either wind tunnel or computational fluid dynamics (CFD) air dispersion modeling is highly recommended to analyze and make recommendations on these factors. Where this is done, it must assess the possibility of re-entrainment of any and all nearby exhausts into any and all nearby intakes. For example, where a new building is being designed, the CFD or wind tunnel analysis considers the impact of the new building as well as near-by existing buildings and other new and existing obstacles and considers new and existing exhaust relative to new and existing intakes.

When using CFD, certain factors shall be considered in the evaluation of external flow type scenarios. First, the size of intakes, chimneys, etc. in an external flow problem in comparison to the overall size of the solution domain considered is usually small. In terms of creating computationally tractable problems, it is difficult to resolve the grid close to these sources of heat, momentum, or concentration without being subject to numerical diffusion. To highly minimize the numerical diffusion augments and the effective viscosity, the solution domain shall use advance grids (meshing) or higher order differencing schemes. Second, the most widely accepted turbulence model used in CFD, namely the k-turbulence model, over-predicts turbulent viscosity in regions of decelerating flow. Therefore, the model shall be based on the assumption that the turbulent viscosity is the same in all three coordinate directions; that is, the viscosity is orthotropic. This is untrue for highly curved, swirling, or buoyant flows. All of these forms of flow regime are typically present in external flows of interest to some extent. The effects of this can be offset by alternatives, but they are subject to various problems.

To alleviate the concerns from the numerical simulation aspect, a series of grid refinement tests shall be carried out to minimize the effect of numerical diffusion in this calculation. The numerical diffusion in three dimensions can be approximated, using Patankar (1980), as:

$$\Gamma = \rho V \left[ \frac{d_x d_y n_x n_y}{d_x n_x + d_y n_y} + \frac{d_y d_z n_y n_z}{d_y n_y + d_z n_z} + \frac{d_z d_x n_z n_x}{d_z n_z + d_x n_x} \right]$$

Where:

$r$  = fluid cell density

$V$  = fluid speed

$(n_x, n_y, n_z)$  = unit vector // to flow

$d_x, d_y, d_z$  = cell dimensions

Owing to the complex nature of this, the approach and the methodology of these calculations need to be agreed upon between the NIH and the contractor.

The results of such tests will be approved by the NIH. If it is found that the numerical diffusion issue cannot be addressed in a single model, then a “zoom-in” approach will be used. In this zoom-in approach, an initial model will be constructed that will represent the laboratory building plus all the surrounding buildings. The results from this initial simulation will then be taken from a volume immediately surrounding the laboratory building and applied to a second model that represents only the laboratory building and its immediate surroundings. If necessary, grid refinement tests will also be applied to the second model to ensure that numerical diffusion is eliminated as much as possible.

The following will be considered in this study. (Details and clear methodology for the calculations will be provided by the NIH. Contact Farhad Memarzadeh, Ph.D., P.E., ORF, for assistance and guidance.)

- A methodology for the calculation of reentrainment into the building.
- A methodology for the calculation of odor and health threshold limits (in mg/m<sup>3</sup>) and their comparison against the numerical analysis data.
- A methodology for the determination of pass/fail criteria based on the threshold limit.
- Alternate wind speeds and directions from appropriate wind rose data.

## C. Fume Hood Testing and Alarms System by Farhad Memarzadeh, Ph.D., P.E., of the National Institutes of Health

Fume hoods in new laboratory facilities shall have a pressure-independent flow-monitoring device connected to a local audiovisual alarm within the laboratory area. For existing facilities, the implementation of airflow devices for fume hoods occurs during the

renovation phase. When the fume exhaust falls below a preset safety level, the alarm will sound and the alarm light will come on.

All parts that are to be in contact with vapors/fumes in the hood, i.e., the sensing device, wiring, etc., shall be chemically resistant. All alarm systems shall be UL approved. There shall be a means to shut off the audible alarm to reset. The alarm shall have an internal timer so that the audible alarm is reactivated after a specified time (adjustable between 5 minutes and 15 minutes). The alarm shall have the capability to set the controller's setpoint to the safety level desired. There shall be a means for setting the controller's setpoint to the exhaust level desired. This adjustment shall be "internal" so that it is not readily adjustable by operating personnel. Upon return to normal flow, the alarm shall sound again until reset.

The ACGIH Guidelines are referenced in the *DRM* for fume hood testing. The ACGIH requirements do not specifically address all testing issues required by the NIH. The following criteria shall be used for testing fume hoods in NIH buildings:

The fume hood manufacturer, no later than 30 days after receipt of the order, shall provide to the owner the use of a state-of-the-art fume hood test facility meeting the requirements of the latest SMACNA Standard LF 10.

The hood manufacturer shall conduct modified ASHRAE Standard 110, 1995, protocol of 1,800 mm hood of similar design to the type specified. The bypass shall be designed so that face velocity does not exceed the maximum as the sash is lowered in a variable volume hood. Variable volume fume hood protocol of 1,800 or 1,200 mm shall be tested in accordance with the Modified ASHRAE 110 Test for minimum baseline requirements. The manufacturer shall provide a fume hood control system at its state-of-the-art test facility meeting the requirements of the latest SMACNA standard LF 10 on its cost for acceptance by the NIH prior to the delivery of hoods for installation. The minimum of 50% installed hoods at site will be again offered for testing on-site by the contractor after installation and building balance prior to occupancy. The contractor shall arrange for tests to be conducted by an NIH-approved independent testing contractor. The specifications shall clearly identify the type of measurement devices that test a constant face velocity, such as hot wire anemometer, heated thermocouple anemometer,

impact tube and side wall or other static tap, pitot tube, etc., or measure volume or mass flow rate using devices such as orifice and differential pressure measurement system, nozzle and differential pressure measurement system, turbine flow meter, swirl flow meter, and vortex shedding meter. A hood of design similar to the type specified in the ASHRAE Standard 110 will have the parameters described in the next paragraph.

**Fume Hood Testing: Note: This item must be included in the balancing specifications, the fume hood control specifications, and the hood specifications.**

**1. Fume Hood Containment Testing (On-Site):**

Laboratory areas and variable volume fume hoods shall be tested as installed to assess the level of containment. The test identified below was created by Farhad Memarzadeh, Ph.D., P.E., of NIH in 1997 and revised by Memarzadeh and Brightbill in 1999 and shall be performed during static and dynamic conditions. Testing shall be conducted as outlined below for 50% of the hoods provided in the project. Tests shall be characterized and referred to in two basic categories, "Static" and "Dynamic". While elements of both static and dynamic testing exist in both test categories, these names are generally used for reference.

- a. **Static Testing:** Testing shall be conducted in accordance with ASHRAE 110 — *Method of Testing Performance of Laboratory Fume Hoods* with the following modifications. This is primarily a test of the hood and laboratory configuration.

Hoods will be tested with simulated apparatus. This apparatus will consist of two each 3.8 L round paint cans, one 300 mm x 300 mm x 300 mm cardboard box, and three each 150 mm x 150 mm x 300 mm cardboard boxes. These items will be positioned from 150 mm to 250 mm behind the sash, randomly distributed, and supported off the work surface by 50 by 50 mm blocks.

- The test gas will have a 6 L/min flow rate.
- Each test duration will be 5 minutes.
- Acceptable test results shall not exceed 0.05 ppm.



- At the conclusion of each 5 minute test, there will be three rapid walk-bys at 300 mm behind the manikin. Each two walk-bys will be spaced 30 seconds apart. If there is a rise in test gas concentration, it cannot exceed 0.10 ppm and must return to 0.05 ppm within 15 seconds.
- There will be a minimum of three and a maximum of five persons in the test room during the test procedure.
- Representatives of the NIH will witness the tests.

2. **Dynamic Testing:** Dynamic testing primarily tests the dynamic performance of the fume hood control system. This group of tests measures hood performance parameters through various dynamic “events.” Events shall include four sash movements up and down across differing ranges: 25–100 percent and 50–100 percent, sash movements of other hoods on the exhaust duct, walk-bys in front of the hood, and opening and closing the laboratory door commensurate with a person entering and exiting the room. Hood parameters to be determined for each event are defined as follows:

- **Measured Face Velocity (FV<sub>m</sub> expressed in m/s):** Face velocity measured in the plane of the sash. Samples shall be recorded at no less than 10 Hz. Sensing methodology shall have an internal time coefficient of no more than 100 ms.

Definitions:

- a. The internal time constant (ITC) is the amount of time it takes the sensor to respond 63 percent of the way to a step change.
- b. The response time is the length of time to get to within the stated accuracy of the sensor.
- c. Response time = ITC x 3 or 5 depending on the accuracy. Example: If the response time is 200 ms, the ITC = 40–70 ms.

There shall be a point sensor located in the middle of the face opening when the sash is

at the lowest position during the tested event. No fewer than three point sensors shall be used. Averages shall be calculated for any point in time to assess overall measured face velocity; however, individual sensor samples shall be used in calculating turbulence intensity (TI).

- **Total Exhaust Airflow (TEF expressed in L/s):** Total exhaust flow measured in the main exhaust duct leaving the hood. This parameter shall be recorded at no less than 10 Hz. The sensing methodology used for the recorded data shall represent the total airflow through the full range of flows and be validated by independent multipoint measurement. If the fume hood control system uses a flow-sensing element, that element may be used assuming it can be calibrated across the full range of flow. Sensing elements must have an internal time coefficient of no more than 20 ms.
- **Variable Face Area (FA<sub>v</sub> expressed in meters):** Face area of the hood that varies as the sash is moved within specified limits.
- **Fixed Face Area (FA<sub>f</sub> expressed in meters):** Face area of the hood with sash at minimum position (minimum position shall correlate with the minimum bypass flow through the hood).
- **Hood Airflow Leakage (HAL expressed in L/s):** The difference in airflow between the measured airflow through the face (at minimum position) and the total airflow measured in the exhaust duct.
- **Calculated Face Velocity (FV<sub>c</sub>):** Face velocity determined from the following equation:  $(TEF - HAL \times 1000) / (FA_v + FA_f)$ .
- **Steady State Face Velocity (SSFV):** The average of all sampled face velocities for a 5 second period. Two SSFVs will be determined for both measured face velocity and calculated face velocity; one before the event (SSFV<sub>b</sub>) and one after (SSFV<sub>a</sub>). The SSFV<sub>a</sub> will start 2 seconds after the end of TSS. The second suffix of m for measured and c for calculated shall be used to indicate the type of assessment.
- **Face Velocity Baseline (FVBL):** The average of SSFV<sub>a</sub> and SSFV<sub>b</sub>.

- **Control Linearity (CL expressed in %):**  $\text{Abs}(\text{SSFVa} - \text{SSFVb}) / (\text{FVBL}) \times 100$ .
- **Time to Steady State (TSS10 and TSS5 expressed in seconds):** The elapsed time from the initial sash movement until the FVc reaches and stays within  $\pm 10$  percent or  $\pm 5$  percent of FVBL (as indicated by the subscript).
- **Face Velocity Overshoot/Maximum Deviation (FVO expressed in percent):** Calculated using the Calculated Face Velocity sample farthest from the FVBL (FVf) throughout the test per the following equation:  $(\text{Abs}(\text{FVf} - \text{FVBL}) / \text{FVBL}) \times 100$ . Samples include initial face velocity deviation immediately following the sash movement as the controls initially respond to the movement of the sash.
- **Response Time Constant (RTC expressed in seconds):** Elapsed time between initial movement of the sash and the initial subsequent movement of the exhaust valve.
- **Steady State Deviation (SSD expressed in %):** Face velocity variation from SSFVa or SSFVb as applicable. Calculated using the farthest sample from the applicable SSFV (FVf) using the following equation:  $(\text{Abs}(\text{FVf} - \text{SSFVx}) / \text{SSFVx}) \times 100$ .
- **Controllability (expressed in mV/mm):** Describes controller response to changing sash position, i.e., controller's response signal change per unit distance of sash movement.
- **Sash Position (SP expressed in mm):** For vertical sashes, vertical distance from the sill of the hood to the bottom of the sash. The minimum sash position shall correlate with the position of the sash when the minimum flow through the hood is all through the face. Maximum sash position shall be defined as a distance of 550 to 650 mm. This parameter shall be recorded at no less than 10 Hz.
- **Controller Output (CO expressed in volts):** Control output to the controlling exhaust air valve. This parameter shall be measured and recorded at no less than 10 Hz.
- **Turbulence Intensity (TI expressed in m/s):** Calculated root mean square of the fluctuating face velocity determined using FVm. This value shall be calculated for each of the

steady state conditions preceding and following each event. This shall be correlated with a “box leakage factor” of the installation using the Methodology for Optimization of Laboratory Hood Containment (MOLHC) by NIH Office of Research Services, Farhad Memarzadeh, Ph.D., P.E., principal investigator. While this value does not have a pass/fail requirement, it is the fundamental indicator of containment and therefore shall be clearly reported.

**Figure E.3.A Dynamic Testing Parameters**

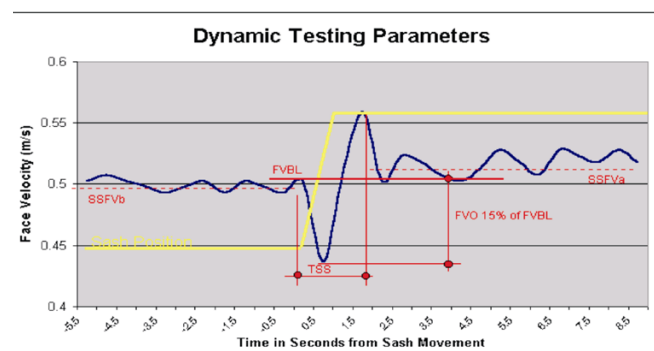

3. **Parameter Performance: Parameter performance requirements:**
  - Face Velocity Baseline (FVBL): 0.51 m/s  $\pm$  .05 m/s
  - Control Linearity (Cl expressed in %): < 2%
  - Time to Steady State10 (TSS10 expressed in seconds): < 2 seconds
  - Time to Steady State5 (TSS5 expressed in seconds): < 3 seconds
  - Face Velocity Overshoot/Maximum Deviation: < 15%, which means at no point throughout the test shall a sample be recorded < 0.43 m/s or > 0.59 m/s
  - Response Time Constant (RTC expressed in seconds): < 0.5 seconds
  - Steady State Deviation (SSD expressed in %): < 5% assessed using calculated face velocities
  - Controllability (expressed in mV/mm): > 12 mV/25.4 mm
- a. **Alternate Parameter Performance Requirements:** The following performance parameters are alternate requirements that

can be used in assessing acceptable dynamic responses:

- **Face Velocity Baseline (FVBL):** 0.51 m/s  $\pm$  .05 m/s.
- **Calculated Face Velocity (FVc):** All samples  $> 0.255$  m/s and  $< 0.89$  m/s, meaning that at no time during the event shall the calculated face velocity be outside that range. Any sample recorded beyond that range will result in assessing the response as unacceptable.
- **Control Linearity (Cl expressed in %):**  $< 2\%$ .
- **Time to Steady State<sub>10</sub> (TSS<sub>10</sub> expressed in seconds):**  $< 1.6$  seconds.
- **Time to Steady State<sub>5</sub> (TSS<sub>5</sub> expressed in seconds):**  $< 2$  seconds.
- **Response Time Constant (RTC expressed in seconds):**  $< 0.5$  seconds.
- **Steady State Deviation (SSD expressed in %):**  $< 5\%$  assessed using calculated face velocities.
- **Controllability (expressed in mV/mm):**  $> 12$  mV/25.4 mm.
- **Test Execution:** Testing agency shall be equipped to execute the testing and assess all performance parameters on-site the day of the test. Data acquisition of required parameters shall be simultaneous.
- **Test Documentation:** All testing, calculated, and recorded parameters shall be presented in a report that shows the recorded parameters graphically and tabulates and summarizes all the results. Performance of the hood, the hood controls, and the laboratory in general shall be described and summarized.

**Note:** Fume Hood Control Testing (Off-Site-Mockup) must be included only in the control manufacturer's specifications.

4. **Fume Hood Control Testing (Off-Site-Mockup):** The manufacturer of the proposed fume hood control system shall mock up a fume hood installation and demonstrate the performance of its system to validate that they can meet the

requirements specified herein. The off-site test shall include all parameters under the control of the control system (FVBL, TSS, CL, RTC, SSD, and Controllability). It is not necessary to mock up the installation and assess TI. Events to be tested off-site include all specified sash movements on the hood being tested. Walk-by and door-opening affects are not required for the off-site test.

The testing shall be accomplished by an independent testing agency approved by the A/E and NIH. Reports shall be provided with the laboratory control submittals, and no approval will be given for the fume hood control system until documentation of successful demonstration of the performance requirements is submitted.

#### D. Harmonic Control in Electric Power Systems by Farhad Memarzadeh, Ph.D., P.E., of the National Institutes of Health

1. **Voltage Sag Concerns:** Despite the main advantages provided by VSD's, the concern for nuisance tripping during voltage sag conditions remains. This power quality concern involves the control sensitivity to short-duration voltage sags and momentary interruptions. Actually, many different kinds of controls, and even motor contractors, are sensitive to these voltage sags. Voltage sags caused by faults on the power system represent one of the most important problems that can be experienced by the NIH with sensitive loads. Whenever there is a fault on the transmission or distribution system serving the NIH facility (faults cannot be completely avoided regardless of the system design), there will be either a voltage sag or an interruption. If the fault occurs on a parallel-distribution feeder circuit or on the transmission system, there will be a voltage sag that lasts until the fault is cleared by some protective device (typically 3–30 cycles depending on the fault location). A method of predicting the likelihood of faults in a certain region along with knowledge of equipment sensitivity can be used to determine an "area of vulnerability". A combination of computer short-circuit simulations and lightning performance analysis shall be used to determine the affected area. The VSD controls shall be designed to

handle these voltage sag conditions without tripping. The specifications contain no-ride-through capability. This is an important consideration when VSD's are applied in critical processes such as that of the NIH, where nuisance tripping can cause significant problems. The A/E shall evaluate the level of sensitivity of the controls to voltage sags. If such concern exists, applying power conditioning to the controls themselves will be considered. Ferroresonant transformers can handle voltage sags down to approximately 60 percent of the nominal voltage. This is sufficient to handle virtually all voltage sags caused by single line-to-ground faults on the power system. If additional protection is needed, the controls can be protected with an UPS system, which can handle complete interruptions in the input signal.

2. **Transient Overvoltage Concerns:** Transient overvoltage occurs in connection with capacitor switching. Each time a capacitor is energized, a transient voltage oscillation occurs between the capacitor and power system inductance. The result is a transient overvoltage that can be as high as 2.0 V per unit (of the normal voltage) at the capacitor location. The magnitude is usually less than 2.0 V per unit as a result of dampening provided by system loads and losses. The transient overvoltage caused by capacitor energizing is generally not a concern to PEPCO because its magnitude is usually below the level at which surge-protective devices operate (1.5 to 2.0 V per unit). However, these transients can be magnified at the NIH facility if the NIH has low-voltage capacitor banks for (displacement) power factor correction. The A/E shall check for this matter. When the frequency of a transient overvoltage matches the series-resonant frequency of the NIH transformer coupled with PEPCO capacitor(s) at the East Substation, a low-impedance, high-current (at the resonant frequency) condition results. As this large current passes through the NIH transformer, it induces a large voltage "drop" that passes through zero voltage to create a large voltage of opposite sign (because of a phase-angle change) at the resonant frequency. The VSD and the NIH paralleled capacitor (and their surge protection devices) then see this magnified voltage

(compared to distribution feeder voltage). When the resonant-frequency current completes its path to ground through the capacitor, the voltage experiences a "boost" to the ground-reference voltage. The magnification of capacitor-switching transients is most severe when the following condition exists: The capacitor switch on the higher voltage system is much larger (kVAR) than the capacitor at the low-voltage bus. Generally, this situation occurs most frequently for substation switching. The frequency of oscillation that occurs when the high-voltage capacitor is energized is close to the resonant frequency formed by the stepdown transformer in series with the low-voltage capacitor. There is little resistive load on the low-voltage system to provide dampening of the transient, as is usually the case for industrial plants (motors do not provide significant damping of these transients). It is not uncommon for magnified transients at low-voltage capacitors to range from 3.0 to 4.0 V per unit. These transients have significant energy associated with them and are likely to cause failure of protective devices, metal oxide varistors (MOV's), electronic components (silicon-controlled rectifiers, etc.), and capacitors. VSD's are particularly susceptible to these transients because of the relatively low peak-inverse voltage ratings of the semiconductor switches and the low-energy ratings of the MOV's used to protect the VSD power electronics. The following shall be evaluated and identified in the specifications to control these magnified transient overvoltages: using vacuum switches with synchronous closing controls to energize the capacitor bank and control the capacitor-switching transient; providing high-energy MOV protection on the 480 V buses (the energy capability of these arresters shall be at least 1 kJ); or using tuned filters for power factor correction instead of just shunt capacitor banks (the tuned filters change the frequency response of the circuit and usually prevent magnification problems; this solution combines power factor correction, harmonic control, and transient control).

3. **Electromagnetic Interference and Radio Frequency Interference Concerns:** IEEE Standard 519, *Recommended Practices and Requirements for Harmonic Control in Electric Power Systems*,

recommends limits for voltage distortion and harmonic current resulting from non-linear loads. However, the IEEE standard is not intended to cover the effects of radio frequency interference (RFI). As a result, specifications will occasionally refer to Federal Communications Commission (FCC) *Rules and Regulations*, Volume 2, Part 15, Subpart J, Class A (referred to as “FCC rule”) to establish limits on electromagnetic emission for VSDs. The FCC rule was printed in October 1982 primarily for computing devices. Computers generate RF energy and possibly cause interference with nearby equipment if misapplied. Generally, the rule sets conducted and radiation RF limits for electronic devices using timing signals or digital techniques with pulse rates in excess of 10,000 pulses per second. Technically speaking, VSD’s with high-frequency timing circuits conform to this description, although they are not intended as a computing device described in the FCC rule. The primary and more significant source of electromagnetic interference (EMI) from a VSD stems from the power circuits, and, in this respect, drives become an incidental radiation device. The only requirement for incidental radiation devices in the FCC rule is that they shall be operated so that the RF energy emitted does not cause harmful interference. If so, the operator must eliminate the interference. All VSD’s, regardless of the manufacturer, will produce electromagnetic emission to some degree. Primarily, these emissions are due to the steep wave fronts and very rapid switching of power semiconductors in the VSD. Typically this occurs when transistors, GTO’s, or other “fast devices” are gated on and off in DC chopper circuits and inverter power circuits for PWM, current source, and six-step drives. Typically, conductors to the VSD’s and motor act as an antenna and radiate the RF energy into the media. Therefore, it is possible for RF to be induced into nearby antennas and other conductors and be carried to the loads in that circuit. Holding a portable AM radio near a power outlet in close proximity to an EMI source can be evidence of this situation. Distributive digital control (DDC) systems, medical alarms system and equipment, telecommunication services, and other electronic equipment utilizing very high frequencies may experience noisy interference or

malfunctions when subject to EM/RF energy. The specification shall clearly outline the corrective measures required. The first and foremost corrective measure to avoid problems associated with EMI is proper routing of the drive conductors in separate metallic conduits (even separate raceways if practical) as remote as possible from any other conductors or suspect equipment. Usually, this will be sufficient to avoid EMI problems. EM/RF filters can be engineered for a system to trap or inhibit high-frequency emissions into power system conductors. However, because of the nature of EMI, the effectiveness of any filter is highly sensitive to where it is installed. Further, it is not certain that the filter will correct the problem even though it may meet FCC limits. Most manufacturers will include this footnote with their literature: “Filters are expensive and usually require additional space. It is recommended that they be furnished only when they are specifically required to avoid or solve a problem after exhausting all proper installation methods. In addition, filters are an additional component and must be considered in the overall reliability of a power system”. To contain RF radiation through the media from the VSD, complete shielding using a metallic enclosure generally is required. This will usually contain most of the radiated RF to a reasonable distance.

#### E. Calculation Protocols for Canopy Hoods over Autoclaves: NIH Local Exhaust Ventilation (LEV) Test Protocol by Farhad Memarzadeh, Ph.D., P.E., of the National Institutes of Health

Volumetric airflow (Q) in CFM of an LEV is determined by:  $Q = V \times A$

Where: V = Average air velocity at hood’s face, point of measurement (ft/min)

A = Area of Hood’s face monitored (ft<sup>2</sup>)

It is required by NIH testing protocols that the calculated velocity at the point of work is 50 ft/min (minimum).

Capture velocity is the calculated air velocity required at the point of steam release and necessary for receiving potentially contaminated air into the hood. This is not a measured value. Capture velocity can be calculated by:

$$V' = Q/1.4 PD$$



Where:

$Q$  = Volumetric airflow through hood (ft<sup>3</sup>/min.)

$K$  = A constant, varying with dimensional relations of canopy and source of contaminant [A value of 1.4 has been established where horizontal dimensions of the canopy are 40% greater than the corresponding dimensions of the source.]

$P$  = Perimeter of work area, or perimeter of source (ft.)

$D$  = Vertical distance between source (top of autoclave door) and canopy (ft.)

$V'$  = required average air velocity through area between source and canopy (fpm).

In the setting of a canopy hood located above an autoclave or sterilizer door, the “work area” is defined as the vertical planar surface exposed when the sterilizer door is opened. For the purposes of calculation, parameter  $D$  will be taken as the height between the top of the sterilizer door and the capture area of the hood. The site of contaminant generation is the top of the door as defined by NIH for this protocol. Per NIH instruction, parameter  $P$  will be taken as that sterilizer door width and a horizontal extension (width of hood’s face) to form a rectangle or square.

Current building design calls for installation of all canopy hoods at 2440 mm above finished floor. Recent discussions with ORFDO have indicated this height can be reduced to 1980 mm. There will therefore be sufficient headroom for standing immediately in front of the autoclave when it is not in use.

**A Crucial Note:** A deep skirt around the edges of a canopy used over autoclaves is recommended. The thermal head or stack effect can cause some spillage around the edges of the canopy if there is not sufficient skirt depth for effective containment, during the exhaust transition to the duct. (See following pages for example of canopy currently in use over an autoclave).

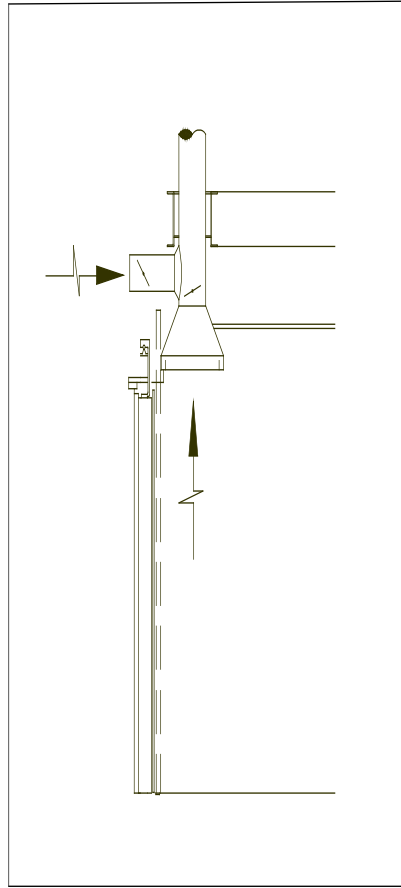

**Placement of canopy directly over rising steam is essential for 100% receiving effectiveness.**





**Example of Calculations for above Canopy:**

With current hood flow, the capture velocity is:

$$Q = VA$$

$$V = 301 \text{ avg. (fpm)}$$

$$A = 5.25 \text{ ft. squared}$$

$$Q = 1580.25 \text{ CFM}$$

$$V' = Q/1.4 \text{ PD}$$

$$V' = 1580.25 \text{ CFM}/1.4 \text{ (6.42 ft. x 1.75 ft.)}$$

$$V' = 100.47 \text{ ft./min., } > 50 \text{ ft./min minimum}$$

A minimal hood flow, with a face velocity of 149.8 fpm, will deliver a capture velocity of 50 ft/min. Because of the hood's design with a deep skirt, its effective accommodation and containment capacity is maintained.

#### F. Selecting and Specify Variable Frequency Drives for HVAC Systems by Farhad Memarzadeh, Ph.D., P.E., of the National Institutes of Health.

##### ABSTRACT

Increasing energy costs over the past decade have given rise to the use of Variable-Speed Drives (VFD's) in efforts to reduce energy costs. The reliability of these drives have greatly improved over the first generations' and, as sales have increased, the cost has dropped to a point where these drives are very cost-effective if properly applied.

For variable-speed drives to be considered for a HVAC application, certain basic requirements will increase their effectiveness. HVAC systems that generally benefit from VFD's include air handling systems that can afford a turn down of at least 20% due to the load variation in the space that are serving, secondary pumping for chilled water systems, hot water pumps, and most other pumping systems with variable-flow requirements. VFD's generally are not effective for primary chilled water or other pumping systems where constant flow is desired.

This article describes in detail different types of VFD's and addresses specific issues regarding the usage and specification of VFD's.

#### TYPES of VARIABLE FREQUENCY DRIVES

Variable frequency drives (VFD's), a type of variable speed drive, are motor controllers that vary the speed of squirrel cage induction motors. VFD's save substantial energy when applied to variable-torque loads, and result in reductions in electricity bills in most facilities. These energy savings are possible with variable-torque loads, such as fans and pumps, because torque varies as the square of speed, and horsepower varies as the cube of speed. For example, if fan speed is reduced by 20%, motor horsepower (and energy consumption) is reduced by 50%. VFD's generate variable voltage and frequency output in the proper volts/hertz ratio for the motors from the fixed utility-supplied power. VFD's can be retrofitted into existing motor systems, and can operate both standard and high-efficiency motors ranging in size from 1/3 HP to several thousand HP. Unlike mechanical or hydraulic motor controllers, they can be located remotely and do not require mechanical coupling between the motor and the load. This simplifies installation and alignment of motor systems.

Variable-flow applications where throttling or bypass devices are used to modulate flow are good candidates for VFD's. These include centrifugal fans, pumps (centrifugal, propeller, turbine), agitators, and axial compressors. If HVAC fans have inlet vanes or outlet dampers to throttle full air output installed in variable-air-volume systems, these dampers or vanes typically can be removed or disabled and retrofitted with VFD's. Circulation pumps for chilled water often have throttling or bypass valves that can be retrofitted with VFD's.

Three major VFD designs are commonly used: pulse width modulation (PWM), current source inverter (CSI), and variable voltage inverter (VVI). A fourth type, the flux vector PWM drive, is gaining popularity but is considered too expensive and sophisticated for normal applications. Knowing the characteristics of the load is critical for evaluating the advantages and disadvantages of each available technology.

1. **Pulse width modulation (PWM)** is the dominant VFD design in the 1/2 HP to 500 HP range because of its reliability, affordability and availability. PWM outputs emulate sinusoidal power waves by varying the width of pulses in each half cycle. Advantages of PWM's are low harmonic motor heating, excellent input displacement power factor, high efficiencies at 92% to 96%,

and ability to control multiple motor systems with a single drive.

2. **Current source inverter (CSI)** designs are quite reliable due to their inherent current-limiting characteristics and simple circuitry. CSI's have regenerative power capabilities, meaning that CSI drives can reverse the power flow back from the motor through the drive. However, CSI's "reflect" large amounts of power harmonics back to the source, have poor input power factors, and produce jerky motor operations (cogging) at very low speeds. CSI's are typically used for large (over 300 HP) induction and synchronous motors.
3. **Voltage source inverter (VSI)** designs are similar to CSI designs, but VSI's generate variable-frequency outputs to motors by regulating voltage rather than current. Harmonics, power factor, and cogging at low frequencies can be problems.

The best applications for VFD's are large motors that can operate for many hours each year at reduced speeds. Some opportunities common in facilities include the following:

1. **Variable-air-volume HVAC fans.** Air flow in older VAV systems is usually controlled by opening and closing dampers or inlet vanes. Because the systems often operate at low air flow, large energy savings are possible by conversion to VFD's. VFD's vary motor speed in order to match fan output to varying HVAC loads.
2. **Cooling tower fans.** Cooling towers may be good candidates for VFD's because motors are large, fans can operate for long periods of time, and loads can vary both seasonally and diurnally.
3. **Circulating water pumps** for chillers and boilers. Pumping systems can be made variable by sequencing fixed-speed pumps and a single variable speed pump. This will save the cost of installing VFD's on each pump.
4. **Special industrial applications** such as grinding and materials handling where precise speed control is required. The economics depend on the size and run-time of the motors involved.

VFD's should be properly specified and installed to avoid generation of excessive electrical noise and harmonics as well as damage to their electronics. This includes proper grounding, mounting, connection, voltage, and cooling. The specification of the VFD's should as the minimum include the following:

1. What level of reliability is required of the VFD system?
2. What operational overloads and starting conditions are required by the application?

Typical requirements may be: Variable torque = 115% for 1 minute, Constant torque = 150% for 1 minute

3. How will control commands for the VFD be generated by the process?
  - Manual/potentiometer
  - Analog current loop 4-20 mA
  - Serial communication (RS232, RS485, etc.)
  - Isolated or non-isolated
  - Process feedback (pressure, temperature, flow, etc.)
4. What characteristic surges, sags or momentary discontinuities are present in the supply? Are there any other non-linear loads on the feeder?
  - KVA, Short circuit level
  - Power factor capacitors
  - Breaker reclosing
  - Lightning
5. What levels of voltage distortion exist on the power system before the VFD is applied? What harmonic current spectrum will be injected into the supply system by the VFD? What is the magnitude of distortion on the supply voltage before and after? Will this harmonic current injection affect other loads?
6. What speed range is required? Will the load be operated beyond base speed?
7. Are all parts of the rotating load suitable for the range of vibration excitation frequencies?

8. What waveform does the VFD produce? Are there any constraints on motor connection length?
9. Is the motor sized to provide necessary load torque while operating at reduced speed? The power capability of the motor may be restricted at low speeds. Compare the motor output capability with the load requirement. An additional cooling fan may be required for constant torque loads. (This pertains to constant torque systems, such as compressors, etc.)
10. What heat rejection occurs in the VFD controller? How are the losses removed from the equipment? The heat generated within the VFD is normally removed by air or water cooling.
11. What is the range of voltage and frequency of the electric supply which will permit full rated output of the VFD? What happens outside the range? What line transients can be tolerated? What is the VFD input power factor?
12. How does the VFD operate under fault conditions? For example, mechanical overload, electrical short circuit in the motor circuit or a ground fault in the load system.
13. What motor protection is provided by the VFD equipment? What additional protection is advised for comprehensive system protection, e.g., overload, overspeed, reverse rotation.
14. What information is available from the manufacturer for system operations and maintenance? What self diagnostic tools are included or available? Warranty offered? Training available? Operation and maintenance manuals?
15. Total Power Factor (i.e., Real P.F. and Apparent P.F.). The difference between the two is caused by inductance (reactive element) in transformers, motors, etc.
16. Harmonic Voltages and Currents

Variable Frequency Drives (VFD's) inject harmonic currents into the power system due to the non-linear nature of switching in electronic power devices. The harmonic currents combined with the system impedance frequency response

characteristic and create harmonic voltage distortion. The harmonic voltages and currents can cause spurious operation of PEPCO and NIH relays and controls, capacitor failures, motor and transformer overheating, and increased power system losses. These problems are usually compounded by the application of power factor correction capacitors (especially on the NIH's low-voltage system), which can create resonance conditions that magnify the harmonic distortion levels. Several concerns associated with harmonic distortion levels need to be addressed in the specification. This will avoid significant harmonic-related problems with both the VFD equipment and the NIH operations controlled. These concerns include the following:

- Harmonic distortion on both the supply side and motor side of the drive
- Equipment derating due to harmonic distortion produced by VFDs
- Audible noise caused by high-frequency (several kilohertz) components in the current and voltage
- Harmonic filter design and specification

#### 17. Nuisance Tripping Concerns

A three-phase VFD system consists of three basic components (rectifier, dc link, and inverter) and a control system. The rectifier converts the three-phase 60 Hz ac input to a dc signal. Depending on the system, an inductor, a capacitor, or a combination of these components smoothes the dc signal (reduces voltage ripple) in the dc link. The inverter circuit converts the dc signal into a variable-frequency ac voltage to control the speed of the induction motor. Since for this application a Voltage-Source Inverter (VSI) Drive is considered, the concerns for this particular device are outlined below. These drives (the most common types up to 300 hp) use a large capacitor in the dc link to provide a relatively consistent dc voltage to the inverter. The inverter then chops this dc voltage to provide a variable-frequency ac voltage for the motor. VSI drives can be purchased off the shelf and employ pulse-width-modulation (PWM) techniques to improve the quality of the output voltage waveform. However, here is a concern

regarding nuisance tripping due to capacitor switching transients. Small VFD's have a VSI rectifier (ac to dc) and use as PWM inverter (dc to ac) to supply the motor. This design requires a dc capacitor to smooth the dc link voltage. The controls for this type of drive have protection for dc overvoltages and under voltages with narrow thresholds. It is not uncommon for the dc over voltage control to cause tripping of the drive whenever the dc voltage exceeds 1.17 per unit (for this particular application 760 volts for a 480 volt application). Since the dc capacitor is connected alternately across each of the three phases, drives of this type can be extremely sensitive to overvoltages on the ac power side. One event of particular concern is capacitor switching on the PEPCO system. PEPCO voltage switching transients result in a surge of current into the dc link capacitor at a relatively low frequency (300–800 Hz). This current surge charges the dc link capacitor, causing an over voltage to occur (through Ohm's law). The over voltage (not necessarily magnified) exceeds the voltage tolerance thresholds associated with the over voltage protection, which most likely will trip the VFD out of service. This is called nuisance tripping because the situation can occur day after day, often at the same time. Several methods are available to ameliorate such tripping; some are simple and some costly. Use of a harmonic filter to reduce over voltages, an expensive alternative, is effective in protecting drives from component failure, but may not completely eliminate nuisance tripping of small drives. The most effective (and inexpensive) way to eliminate nuisance tripping of small drives is to isolate them from the power system with series inductor (chokes). With a concomitant voltage drop across the inductor, the series inductance of the choke(s) reduce(s) the current surge into the VFD, thereby limiting the dc over voltage. The most important issue regarding this method is that the designer should determine the precise inductor size for each particular VFD; this requires a detailed transient simulation that takes into account capacitor size, transformer size, etc. The choke size must be selected carefully. If the choke has too much impedance, it can increase harmonic distortion levels and notching transients at the

drive terminals. Chokes for this application are commercially available in sizes from 1.5% to 5% of the VFD impedance at various hp ratings. A size of 3% is sufficient to avoid nuisance tripping due to capacitor switching operations. Standard isolation transformers serve the same purpose.

## 18. Voltage Sag Concerns

Despite the many advantages provided by VFDs, the concern for nuisance tripping during voltage sag conditions remains. This power quality concern involves the control sensitivity to short-duration voltage sags and momentary interruptions. Actually, many different kinds of controls, and even motor contractors, are sensitive to these voltage sags. Therefore, voltage sags caused by faults on the power system represent one of the most important problems that can be experienced by the NIH with sensitive loads. Whenever there is a fault on the transmission or distribution system serving the NIH facility (faults cannot be completely avoided regardless of the system design), there will be either a voltage sag or an interruption. If the fault occurs on a parallel distribution feeder circuit or on the transmission system, there will be a voltage sag that lasts until the fault is cleared by some protective device (typically 3–30 cycles depending on the fault location). A method of predicting the likelihood of faults in a certain region along with knowledge of equipment sensitivity can be used to determine an “area of vulnerability.” A combination of computer short-circuit simulations and lightning performance analysis should be used to determine the affected area. The VFD controls should be designed to handle these voltage sag conditions without tripping. Ride thru capability is an important consideration when VFDs are applied in critical processes such as NIH, where nuisance tripping can cause significant problems. The designer should evaluate the level of sensitivity of the controls to voltage sags. If such concern exists consideration should be given to applying power conditioning to the controls themselves. Ferroresonant transformers can handle voltage sags down to approximately 60% of the nominal voltage. This is sufficient to handle virtually all voltage sags caused by single line-to-ground faults on the power system. If

additional protection is needed, the controls can be protected with an uninterruptible power supply (UPS) system, which can handle complete interruptions in the input signal.

#### 19. Transient Over voltage Concerns

Transient overvoltages occur in connection with capacitor switching. Each time a capacitor is energized, a transient voltage oscillation occurs between the capacitor and power system inductance. The result is a transient over voltage that can be as high as 2.0 per unit (of the normal voltage) at the capacitor location. The magnitude is usually less than 2.0 per unit due to dampening provided by system loads and losses. The transient overvoltages caused by capacitor energizing are generally not a concern to PEPCO because their magnitude is usually below the level at which surge protective devices operate (1.5–2.0 per unit). However, these transients can be magnified at the NIH facility if the NIH has low-voltage capacitor banks for (displacement) power factor correction. (The designer should check for this matter.) When the frequency of a transient over voltage matches the series-resonant frequency of the NIH's transformer coupled with the PEPCO'S capacitor(s) at the East Substation, a low-impedance, high-current (at the resonant frequency) condition results. As this large current passes through the NIH transformer it induces a large voltage “drop” that passes through zero voltage to create a large voltage of opposite sign (because of a phase-angle change) at the resonant frequency. The VFD and the NIH paralleled capacitor (and their surge protection devices) then see this magnified voltage (compared to distribution feeder voltage). When the resonant-frequency current completes its path to ground through the capacitor, the voltage experiences a “boost” to the ground-reference voltage. The magnification of capacitor switching transients is most severe when the following conditions exist: The capacitor switched on the higher voltage system is much larger (kVAR) than the capacitor at the low-voltage bus. Generally, this situation occurs most frequently for substation switching. The frequency of oscillation that occurs when the high-voltage capacitor is energized is

close to the resonant frequency formed by the step-down transformer in series with the low-voltage capacitor. There is little resistive load on the low-voltage system to provide dampening of the transient, as is usually the case for industrial plants (motors do not provide significant dampening of these transients). It is not uncommon for magnified transients at low-voltage capacitors to range from 3.0–4.0 per unit. These transients have significant energy associated with them and are likely to cause failure of protective devices, metal oxide varistors (MOV's), electronic components (silicon-controlled rectifiers, etc.), and capacitors. VFD's are particularly susceptible to these transients because of the relatively low peak-inverse voltage ratings of the semiconductor switches and the low-energy ratings of the MOV's used to protect the VFD power electronics. The following should be evaluated and identified in the specifications to control these magnified transient overvoltages: By using vacuum switches with synchronous closing control to energize the capacitor bank and control the capacitor switching transient. By providing high-energy MOV protection on the 480 volt buses. (The energy capability of these arresters should be at least 1 kJ.) By using tuned filters for power factor correction instead of just shunt capacitor banks. (The tuned filters change the frequency response of the circuit and usually prevent magnification problems. This solution combines power factor correction, harmonic control, and transient control.)

#### 20. EMI and RFI Concerns

IEEE Std. 519, Recommended Practices And Requirements for Harmonic Control In Electric Power Systems, recommends limits for voltage distortion and harmonic current resulting from non-linear loads. However, the IEEE standard is not intended to cover the effects of radio frequency interference. As a result, specifications will occasionally refer to FCC Rules & Regulations volume 2 Part 15 Subpart J Class A (referred to as “FCC rule”) to establish limits on electromagnetic emission for VFD's. The “FCC rule” was printed in October 1982 primarily for computing devices. Computers will generate RF energy and possibly cause interference



with nearby equipment if misapplied. Generally, the rule sets conducted and radiation RF limits for electronic devices using timing signals or digital techniques with pulse rates in excess of 10,000 pulses per second. Technically speaking, VFD's with high frequency timing circuits conform to this description, although they are not intended as a computing device described in the "FCC rule." The primary and more significant source of EMI from a VFD stems from the power circuits, and in this respect, drives become an incidental radiation device. The only requirement for incidental radiation devices in the "FCC rule" is that they shall be operated so that the RF energy emitted does not cause harmful interference - if so, the operator must eliminate the interference. All VFD's, regardless of the manufacturer, will produce electromagnetic emissions to some degree. Primarily, these emissions are due to the steep wave fronts and very rapid switching of power semi-conductors in the VFD. Typically this occurs when transistors, GTO's or other "fast devices" are gated on and off in dc chopper circuits, and inverter power circuits for PWM, current source, and six-step drives. Typically conductors to the VFD's and motor act as an antenna, and radiate the RF energy into the media. Therefore it is possible for RF to be induced into nearby antennas and other conductors, and be carried to the loads in that circuit. Holding a portable AM radio near a power outlet in close proximity to an EMI source can be evidence of this situation. DDC control system, telecommunication services and other electronic equipment utilizing very high frequencies may experience noisy interference or malfunctions when subject to EM/RF energy. The specification should clearly outline the corrective measures required. The first and foremost corrective measure to avoid problems associated with EMI is proper routing of the drive conductors in separate metallic conduits, and even separate raceways, if practical, and as remote as possible from any other conductors or suspect equipment. Usually, this will be sufficient to avoid EMI problems. EM/RF filters can be engineered for a system to trap or inhibit high frequency emissions into power

system conductors. However, due to the nature of EMI the effectiveness of any filter is highly sensitive to where it is installed. Further, it is not assured that the filter will correct the problem even though it may meet FCC limits. Most manufacturers will include this footnote with their literature. "Filters are expensive and usually require additional space. It is recommended that they be furnished only when they are specifically required to avoid or solve a problem after exhausting all proper installation methods. In addition, filters are an additional component and must be considered in the overall reliability of a power system." To contain RF radiation through the media from VFD, complete shielding using a metallic enclosure is required. This will usually contain most of the radiated RF to a reasonable distance.

21. Ensure that the power voltage supplied to VFD's is stable within plus or minus 10% to prevent tripping faults.
22. Motors operating at low speeds can suffer from reduced cooling. For maximum motor protection on motors to be run at low speeds, install thermal sensors that interlock with the VFD control circuit. Standard motor protection responds only to over-current conditions.
23. Speed control wiring, which is often 4 mA to 20mA or 0 VDC to 5 VDC, should be separated from other wiring to avoid erratic behavior. Parallel runs of 115V and 24V control wiring may cause problems.

**Precautions** for specifying, installing and operating VFD's are numerous. Improper installation and startup accounts for 50% of VFD failures.

1. Use the VFD startup sheet to guide the initialization check prior to energizing the VFD for the first time.
2. Corrosive environments, humidity above 95%, ambient air temperatures exceeding 40°C (104°F), and conditions where condensation occurs may damage VFD's.
3. If a VFD is started when the load is already spinning, the VFD will try to pull the motor down



to a low, soft-start frequency. This can result in high current and a trip unless special VFD's are used.

4. Switching from grid power to emergency power while the VFD is running is not possible with most types of VFD's. If power switching is anticipated, include this capability in the specification.
5. If electrical disconnects are located between the VFD and motor, interlock the run-permissive circuit to the disconnect.
6. If a motor always operates at rated load, a VFD will increase power use, due to electrical losses in the VFD.
7. Use "inverter duty" motors on new installations that will have VFD's.

# Appendix E

## A/E Submission Requirements

## Document Submission Requirements

The intent of these submission requirements is to ensure consistent, rational, easily understood documents to facilitate reviews by NIH staff.

These requirements are the minimum standards and the specific Scope of Work (SOW) will take precedence on each project. Additional requirements unique to each discipline may be indicated in the individual chapters of the *DRM*. Sufficient detail shall be provided to clearly indicate system parameters and requirements, and shall not be so generic as to require contractors or vendors to perform professional design tasks.

All submissions in each phase of work are required to be given to the NIH in drawing or written form and on digital format as determined by the Project Officer (PO). At the completion of the project final drawings shall be provided in CAD or BIM as specified in the SOW.

All documents provided by NIH to the A/E, including building backgrounds and previous project documents, shall be used for reference and general information only. It is incumbent on the A/E to survey and field verify dimensions, locations, sizes, elevations and other pertinent information for all existing items within the limits of a project.

At the conclusion of each design phase, or as required in the SOW, the required number and size of hard and electronic copies of the plans, specifications and Basis of Design shall be delivered to NIH, as directed by the PO. The final submission shall be signed and sealed by architects and engineers licensed by a state or territory of the United States.

### Coordination, Constructability, Phasing, and Maintainability

Coordination, constructability, phasing, and maintainability are quality-related and risk-management elements inherent to a set of construction documents that will directly impact a project's short and long term success. The A/E shall include these elements in their design and documentation process from project initiation, and shall have routine processes to ensure that these elements have been addressed fully and appropriately.

**Coordination:** The goal of document coordination is for plans, sections, elevations, details, schedules, specifications and other documents of all disciplines to reflect the same information and agree with each other. A fully coordinated set of documents requires less field coordination during construction, and results in fewer conflicts, change orders, RFIs and delays. Examples of coordination include but are not limited to:

- Ceiling devices on mechanical and electrical drawings must be shown on and must not conflict with items on the architectural reflected ceiling plan.
- Structural columns, piping, ductwork and other vertical elements must be shown on architectural plans and must fit within enclosures.
- All equipment and items requiring service and maintenance shall be provided with adequate clearance.
- Phasing, temporary construction, assembly ratings and other conditions impacting multiple systems must be addressed uniformly on all documents and by all disciplines.
- Specifications and drawings must be coordinated to reflect the correct materials, equipment, sizes, etc.
- Documents must incorporate and coordinate with the Basis of Design (BOD), all review comments from previous submissions, and most current requirements, equipment information and other input from users.

The A/E shall use the capabilities of CADD and Building Information Modeling (BIM) where possible to use single models or files between different disciplines so that duplication is avoided and coordination and updates are automatic. BIM should be used where possible for clash detection and to automatically generate schedules and other documents. Changes during design or documentation are particularly critical. The A/E's project manager(s) or production coordinator(s) must ensure that changes are communicated between disciplines and are reflected in all appropriate locations and documents. Each discipline must have a Quality Assurance plan to review and document processes and procedure to assure coordination. A Quality Control review must be conducted by an experienced professional interdisciplinary team to sign-off that the documents have been reviewed for coordination prior to each submission.

**Constructability:** ‘Constructability’ is the ease and efficiency of the construction process. All construction documentation shall be reviewed to increase constructability by identifying and eliminating potential construction obstacles before the start of construction. Examples of constructability issues include but are not limited to:

- Existing site or building conditions that are unusual or which may require mitigation or remediation.
- Systems, materials or equipment that are incompatible or require undue coordination or customization.
- Unusual or untried techniques, materials, equipment or details.
- Unusually long lead items.
- Uncoordinated or incomplete construction documents.
- Overly complex phasing.
- Overly restrictive site access or other work restrictions.

The A/E’s project manager(s) and/or Quality Control team shall review documents for constructability. Potential constructability issues shall be eliminated, or shall be highlighted in the documents and brought to the attention of the NIH Project Officer so that they can be proactively addressed in the construction schedule.

**Phasing:** Phasing is the planned sequential construction of portions of a project so that areas come on-line and/or off-line in stages for the benefit of building operations or occupancy. Phasing may be required in conditions including but not limited to:

- Funding may not be available to complete the entire project in a single phase.
- Swing space may not be available to remove all occupants from the project area.
- Critical utilities or building operations may have to be maintained.
- Access, egress or other functions may have to be maintained.
- Project outside of the A/E scope may affect the work area.

Phasing complicates construction and adds cost and time to projects. The A/E must work with Project Officers to eliminate or simplify phasing where possible. Where phasing is necessary, a plan with the fewest, least complex and most constructible phases shall be developed in an effort to reduce schedule and cost. The A/E shall develop clear, concise phasing documents for all disciplines so that the work during and at the end of all phases is complete and coordinated.

**Maintainability:** Ultimately all completed projects must be maintainable by facilities personnel. Maintainability means the facility is designed and constructed in a manner which promotes efficient and high quality maintenance procedures with minimal impact to facility function and operations. Maintainability may include but not be limited to:

- Appropriate clear access to valves, filters, disconnects, etc. which require routine access by maintenance personnel.
- Specifying materials and equipment which are readily available in the geographic region in which the facility is located to prevent long facility impacts due to equipment production and shipping requirements.
- Providing specifications for attic stock and spare parts for materials and equipment that may result in long facility impacts if hard to obtain material or equipment is required to be replaced per a regular maintenance schedule.
- Proper testing, commissioning, and training is included in the specifications to confirm all equipment is completely operational at the time of turn over; and the facility staff is ready to perform their duties at that time.
- Ensuring routinely accessible items such as valves, damper and disconnects are located within areas which will not impact facility functionality. This would include locating such devices in areas where maintenance personnel would not be required to gown or done special PPE to perform routine operations.

The A/E quality staff should review design concepts for maintainability with facility personnel early in the project to obtain their input. They should then perform reviews throughout the design process to make sure the maintainability requirements are carried through the design

process. For designs located within existing facilities the design team needs to be aware of the impact of maintenance requirements of the new space on existing areas within the facility. This may mean including more valves, dampers or disconnect means to isolate the new space for maintenance without impact to surrounding areas. A facility design with maintainability as part of its central planning will result in increased user satisfaction, greater equipment longevity and lower life cycle costs.

## Drawings

**Application:** Dedicated drawing sheets (plans, details, schedules, etc.) shall be provided for each primary discipline (Civil, Structural, Architectural, Mechanical, Plumbing, Fire Protection, Electrical etc.) applicable to the project.

**Size:** All drawings of the same project must be a uniform standard size.

**Backgrounds:** Consistent backgrounds shall be provided clearly showing salient features at the specific area of work. Backgrounds shall include the immediate project area and all surrounding areas (adjacent rooms, corridors, electrical and mechanical rooms, shafts) necessary to convey the project in the context of the larger building.

**Coordination:** All project information shall be coordinated to avoid conflicts between drawings, between disciplines, narratives and specifications. Duplicate information should be avoided unless required for interdisciplinary coordination. An example of appropriate duplicate information is Mechanical, Electrical, and Plumbing (MEP) devices on an Architectural reflected ceiling plan. In this case devices should be referenced from their respective disciplines' documents to ensure coordination.

Primary MEP equipment rooms and similar multi discipline common spaces involving unique arrangement and access requirements associated with major equipment shall be coordinated between disciplines. Work shall be prominently identified on the respective drawings. Major equipment of other disciplines, as well as significant service access paths that must be preserved or maintained clear, shall be shown in the background through use of thin lines or patterns (such as lightly hatched, cross hatched, dashed/dotted) or otherwise clearly indicated.

**Provisions for Future:** Infrastructure spaces, equipment areas, utilities and other applications with an intended clear and specific need associated with planned future construction or future phasing shall be clearly noted or otherwise reserved to communicate intent and application of reserved space.

**Room Identification:** Provide room names and numbers on all plans (including demolition plans, life safety plans, reflected ceiling plans, all discipline plans). Room numbers shall be comply with NIH room numbering conventions and shall be approved by the PO.

**Conventions and Symbols.** Drawings shall use common industry standard conventions and symbols. Legends shall be provided to identify symbols and abbreviations.

**Line Weight:** Drawings shall employ multiple line weights to improve readability. Similar line weights shall be used by all disciplines. Line weights shall be sufficiently dark to permit photocopying without loss of detail.

**Lettering:** Letters and numbers on drawings shall be a minimum of 3/32" tall when on full sized sheets. This applies to concept and design development drawings as well as construction documents.

**Reference:** Column grid lines with identification shall be provided on all floor plans. Other documents (such as elevations, details, and riser diagrams) shall be provided with similar reference information as appropriate to facilitate clear and efficient document interpretation.

**Scale, North Arrow, Key Plan:** All plans shall have a north arrow. All drawings will be produced with metric or imperial drawing scales, as required by the *DRM* and as specified in the SOW. Scale of drawings shall be as required for legibility on half-size reduced copies. Graphic scales shall be provided on all scaled drawings. All plans showing similar work (including demolition plans, life safety plans, reflected ceiling plans, all discipline plans) shall be at the same scale and in the same orientation. Key plans shall be provided as required to show the areas of work within the context of the larger building or complex.

**CAD Standards:** The National CAD/CIFM Standards shall be followed for all CAD drawing formatting. All drawings shall be created with or compatible with the latest version of the Autodesk building design suite

software package. Building Information Modeling (BIM) shall be utilized for all large or complex projects, projects requiring coordination between disciplines, or as required by the SOW.

**Dimensioning:** All drawings will be produced with metric or imperial dimensions, as required by the *DRM* and as specified in the SOW.

- Dimensions must be legible and in continuous ‘strings’ where possible.
- Dimensions must be tied to column lines and other fixed points where necessary to positively locate items.
- Avoid duplicate dimensions.
- For renovation projects, use ‘Minimum’ or ‘Verify in Field’ notation for critical dimensions. Use ‘+/-’ notation for non-critical dimensions.
- **Metric:** All dimensions shall be in millimeters, unless there is a specific reason to use another unit. On the drawings the unit symbol shall be eliminated and an explanatory note such as “All dimensions are shown in millimeters” provided. All dimensions should end in ‘0’ or ‘5’, unless greater tolerance is specifically required.
- **Imperial:** All dimensions shall be in feet (‘) and inches (”). Plan tolerance should not be less than 1”, and detail tolerance should not be less than ¼”, unless greater tolerance is specifically required.

## Specifications

**Format:** All construction contract specifications shall be created and edited using the latest version of the AIA MASTERSPEC®.

AIA MASTERSPEC® shall be used as the base document for all items and systems that are adequately addressed in MASTERSPEC® sections. The A/E shall edit all MASTERSPEC® sections to ensure appropriate standards of quality for materials and systems, for conformance to the *DRM*, and to address specific project requirements. The A/E shall write new specification sections or use another standardized specification system for a section or item that MASTERSPEC® does not cover.

Each page should be numbered. Specifications should be bound and include a Table of Contents to navigate to the individual specification sections.

**Editing of Specifications:** Specifications shall be edited to reflect the specifics of the project. Each specification section must be carefully cross-referenced with the drawings and with other sections to ensure completeness and coordination. All items and references not pertinent to the project shall be omitted.

## Basis of Design (BOD) and Calculations

**BOD:** Typed, bound BOD shall be produced for the initial design submission and shall be updated and resubmitted at each subsequent submission. Sections shall be provided for each design discipline.

The BOD shall fully document the parameters of the project. In conjunction with the drawings and specifications, the BOD is a permanent record of the building/project design. The BOD shall include discipline narratives, which explain and document all important requirements and decisions made during the design process. Narratives shall comply with the SOW, and shall be tailored to each project. Narratives shall be sufficiently detailed to convey the design intent (e.g., general description, areas served, significant features, provisions for future expansion/flexibility, materials/products to be used, codes, standards, design criteria) and special program requirements pertinent to the design.

In addition, the BOD shall include SOW, project program, a listing of all applicable codes, standards, and regulations, room data sheets, equipment schedule, equipment cut sheets with specific as-selected options identified, meeting minutes and correspondence. Depending on the scope of the project, other items may include budget and cost estimates, geotechnical and survey information, planning alternatives, questionnaires and surveys, studies, benchmarking, sustainability goals and approach, risk analysis and any other information that will provide insight and provide background on the project and its development. The BOD of each submittal may be based on the previous submittal, but must be revised and expanded at each stage to reflect the current state of the design and the basis for which each system has been engineered, constructed, and expected to operate.

**Calculations:** Manual and/or computer based calculations should accompany narratives where required to support technical analysis. Calculations are required for all primary equipment, infrastructure, and distribution



systems unless otherwise approved by NIH. Each set of calculations should start with a summary sheet, which shows all assumptions, references applicable codes and standards, and lists the conclusions. Calculations should include engineering sketches as an aid to understanding by reviewers. The calculations for each submittal should be cumulative, so that the final submittal contains all calculations for the project. Calculations submitted at early stages of the project must be revised later to reflect the final design. Calculations must refer to code, paragraph of code used, standards, and text books used for specific portion of calculation. Refer to drawing number where the results of the calculations have been used where applicable (e.g. number and sizes of re-bars used in reinforced concrete members). Print-out of summary sheets and print-outs which indicate values but do not clearly identify data utilized, inputs and calculation methodology or otherwise do not provide a clear record of how results were obtained are unacceptable. Calculations shall be in the same unit format (metric or imperial) as other project documentation as specified in the SOW.

### Metric Standards for New Construction

All final drawings and specifications for new construction shall be expressed in metric units or dual units (metric and imperial), unless other requirements are specifically provided by the contracting officer (CO). The General Services Administration (GSA) Metric Design Guide, latest edition, and the Metric Guide for Federal Construction shall be used for guidance on how drawings, specifications, and other elements of metric implementation are to be addressed.

**Unit Standards for Renovations and Additions:** All facility renovation and addition design projects shall be based on the unit type (i.e., metric or imperial) for which the facility was originally designed. Units in all design documentation (drawings, specifications, calculations, etc.) shall be consistent and shall not be mixed.

**Unit Standards for Leases:** All lease facility design projects shall use imperial units in accordance with ANSI/BOMA Z65.1.

**Titleblock:** All drawings larger than 11" x 17" shall be on a standard NIH titleblock. All fields, including project identification, date, project officer, and submission, shall be completed.

**Project Cover Sheet:** The NIH standard cover sheet shall be used, and shall include the following:

- NIH building number
- Room number(s), if applicable
- Submission
- Date
- Work request number
- Vicinity map
- Area map

**Other information:** The cover sheet or following sheet(s) shall contain the following:

- Complete and accurate drawing index
- Drawing Index on the Cover Sheet of each discipline (for that discipline)
- Abbreviations and symbols edited and tailored to the project
- Life safety information, including:
  - List of codes and code requirements applicable to the project
  - Life safety plan(s), including fire ratings, common paths of travel, travel distances and other pertinent information for the project area

### NIH Review of Contractor's Submittals

The NIH PO reserves the right to review any contractors' construction and equipment submittals. At the PO's request, copies of contractors' submittals may be required for NIH's review and concurrence. This includes (but is not limited to) critical equipment, research equipment, or for systems where detailed piping and instrumentation drawings and associated data are deferred from initial A/E design. The A/E shall incorporate any and all NIH review comments in the contractor's submittal and the final record documentation package.

## A/E Submission Requirements Matrix

The following is a list of submittal requirements to be provided with each submission. Additional submittal requirements shall be provided as required by the Statement of Work (SOW), as required in individual chapters of the *DRM*, and as required to fully convey, define and address the full scope and complexity of the project. Refer to individual sections of the *DRM* for discipline specific details. All submittals must be provided unless specifically excluded by the Project Officer (PO).

All submissions shall fully address NIH review comments made on previous submissions. Prior to submission all appropriate updates shall be made, and all required clarification and additional information shall be provided to resolve all open issues. I: Initial Submission, U: Updated, F: Final

Submission Requirements	Schematic Design 15%	Design Development 35%	Construction Document 65%	Construction Document 95%	Construction Document Phase 100%
<b>Civil/Site/Landscape</b>					
Basis of Design Report	I	U	U	U	F
Alternate Schemes	F				
Vicinity Plan	I	F			
Existing Site Plan	I	F			
Proposed Site Plans	I	U	U	U	F
Grading and drainage	I	U	U	U	F
Erosion and sediment control	I	U	U	U	F
Plantings, paving	I	U	U	U	F
Site utilities	I	U	U	U	F
Utility profiles		I	U	U	F
Excavation, waste management, etc. as required		I	U	U	F
Demolition Plan	I	U	U	U	F
Details		I	U	U	F
Specifications		I	U	U	F
<b>Architectural</b>					
Basis of Design Report	I	U	U	U	F
Scope of work	F				
Design narrative	I	U	U	U	F
Architectural program	I	U	U	U	F
Tabulation of net and gross areas	I	U	U	U	F
Programming questionnaires	I	F			
Alternate schemes	F				
Building envelope analysis	I	U	F		
Vertical transportation recommendations	I	F			
Sustainability strategies, score sheets	I	U	U	U	F
Major scientific equipment and specialty equipment description	I	U	U	U	F

Submission Requirements	Schematic Design 15%	Design Development 35%	Construction Document 65%	Construction Document 95%	Construction Document Phase 100%
<b>Architectural (continued)</b>					
Code Analysis	I	U	U	U	F
Floor Plans	I	U	U	U	F
Building Elevations	I	U	U	U	F
Building Sections	I	U	U	U	F
Demolition Plans	I	U	U	U	F
Reflected Ceiling Plans	I	U	U	U	F
Enlarged Plans	I	U	U	U	F
Interior Elevations	I	U	U	U	F
Wall Sections	I	U	U	U	F
Details		I	U	U	F
Schedules		I	U	U	F
Specifications		I	U	U	F
<b>Structural</b>					
Basis of Design Report	I	U	U	U	F
Geotechnical data	F				
Calculations	I	U	U	U	F
Summary of structural systems requirements	I	F			
Alternative schemes	F				
Vibration requirements and analysis	I	U	U	U	F
Sustainability strategies, score sheets	I	U	U	U	F
Code Analysis	I	U	U	U	F
Floor Plans	I	U	U	U	F
Demolition Plans	I	U	U	U	F
Section	I	U	U	U	F
Fire-resistive Construction Requirements	I	U	U	U	F
Details		I	U	U	F
Schedules		I	U	U	F
Specifications		I	U	U	F

Submission Requirements	Schematic Design 15%	Design Development 35%	Construction Document 65%	Construction Document 95%	Construction Document Phase 100%
<b>Mechanical</b>					
Basis of Design Report	I	U	U	U	F
Design criteria	I	U	U	U	F
Design conditions	I	U	U	U	F
Applicable codes, standards, regulations	I	U	U	U	F
Major scientific and specialty equipment utility requirements	I	U	U	U	F
Analysis on available utilities	I	U	U	U	F
Systems analysis and recommendations	I	U	U	U	F
Pre-design readings to determine current baseline	I	U	U	U	F
System description, existing and proposed	I	U	U	U	F
Conceptual plans/diagrams	I	U	U	U	F
Redundancy requirements	I	U	U	U	F
Energy recovery requirements	I	U	U	U	F
Calculations including room by room calculations for HVAC	I	U	U	U	F
Life cycle cost analysis	I	U	U	U	F
Numerical analysis on laboratory/animal exhaust plume discharges (where applicable)	I	U	U	U	F
Mechanical equipment cut sheets	I	U	U	U	F
Constructibility, phasing and maintainability requirements	I	U	U	U	F
Engineering monitoring and controls	I	U	U	U	F
Sustainability strategies and score sheets	I	U	U	U	F
Code Analysis	I	U	U	U	F
Floor Plans	I	U	U	U	F
Sections	I	U	U	U	F
Details		I	U	U	F
Schedules		I	U	U	F
Demolition Plans		I	U	U	F
System Diagrams		I	U	U	F
Control Diagrams		I	U	U	F

Submission Requirements	Schematic Design 15%	Design Development 35%	Construction Document 65%	Construction Document 95%	Construction Document Phase 100%
<b>Mechanical (continued)</b>					
Ductwork sizing in plenums and shafts		I	U	U	F
Specifications		I	U	U	F
Commissioning Specifications				I	F
<b>Plumbing</b>					
Basis of Design Report	I	U	U	U	F
Design criteria including general sizing	I	U	U	U	F
Design conditions	I	U	U	U	F
Applicable codes, standards, regulations	I	U	U	U	F
Major scientific and specialty equipment utility requirements	I	U	U	U	F
Analysis on incoming utilities and environmental conditions	I	U	U	U	F
Hydraulic analysis, flow, pressure, water quality	I	U	U	U	F
Systems analysis, material selection	I	U	U	U	F
System description, existing and proposed	I	U	U	U	F
Conceptual plans/diagrams	I	U	U	U	F
Redundancy requirements	I	U	U	U	F
Energy saving requirements	I	U	U	U	F
Calculations	I	U	U	U	F
Life cycle cost analysis	I	U	U	U	F
Plumbing cut sheets	I	U	U	U	F
Constructibility, phasing and maintainability requirements	I	U	U	U	F
Engineering monitoring and controls	I	U	U	U	F
Sustainability strategies and score sheets	I	U	U	U	F
Code Analysis	I	U	U	U	F
Floor Plans	I	U	U	U	F
Plot Plan for Outside of Building Underground Distribution	I	U	U	U	F
Plumbing Riser Diagrams	I	U	U	U	F

Submission Requirements	Schematic Design 15%	Design Development 35%	Construction Document 65%	Construction Document 95%	Construction Document Phase 100%
<b>Plumbing (continued)</b>					
Details	I	U	U	U	F
Demolition Plans	I	U	U	U	F
One Line Flow and Control Diagram	I	U	U	U	F
Schedules		I	U	U	F
Specifications		I	U	U	F
<b>Fire Protection</b>					
Basis of Design Report	I	U	U	U	F
Hydrostatic flow test and water supply analysis	I	F			
Calculation of required water supply	I	U	U	U	F
Requirements for fire protection	I	U	U	U	F
Requirement for fire pump	I	U	U	U	F
Overall system concepts	I	U	U	U	F
Analysis of conceptual design solutions	I	F			
Alternative materials/systems/equipment	F				
Protection analysis report for each alternative	F				
Sizes and capacities of major components	I	U	U	U	F
Code Analysis	I	U	U	U	F
Present Conditions	I	F			
Floor Plans	I	U	U	U	F
Special Fire Suppression Systems	I	U	U	U	F
Integrated Fire Alarm		I	U	U	F
Specifications		I	U	U	F
<b>Electrical/Communications</b>					
Basis of Design Report	I	U	U	U	F
Energy budget	I	U	U	U	F
Overall building connected load requirements	I	U	U	U	F
Electrical service sizing calculations	I	U	U	U	F
Sizing of transformers, generator, UPS etc.	I	U	U	U	F



Submission Requirements	Schematic Design 15%	Design Development 35%	Construction Document 65%	Construction Document 95%	Construction Document Phase 100%
<b>Electrical/Communications (continued)</b>					
Basis of Design Report (continued)					
Equipment cut sheets	I	U	U	U	F
Sustainability strategies, score sheets	I	U	U	U	F
Code Analysis	I	U	U	U	F
Present Conditions	I	U	U	U	F
Floor Plans	I	U	U	U	F
Layouts of Components Where Space is Critical		I	U	U	F
Lighting Plans		I	U	U	F
Riser Diagram for Normal & Emergency Power Distribution	I	U	U	U	F
Details		I	U	U	F
Demolition plans	I	U	U	U	F
Schedules		I	U	U	F
Specifications		I	U	U	F
<b>Telecommunications</b>					
Basis of Design Report	I	U	U	U	F
Site Plans	I	U	U	U	F
Floor Plans		I	U	U	F
Layouts of Components Where Space is Critical		I	U	U	F
Riser Diagram for Telecommunication Distribution	I	U	U	U	F
Specifications		I	U	U	F

# Appendix F

## Room Data Sheets

Laboratory rooms are highly specialized by their nature, and should be individually planned by architects and engineers experienced with laboratory design. Planning should be in consultation with staff familiar with the room's intended use, as well as the Division of Occupational Health & Safety (DOHS), Division of Physical Security Management (DPSM) and all other applicable stakeholders as outlined in [Chapter 2](#). Planning should strike the appropriate balance between flexibility and economy, and should address the comfort and safety of room and building users, the performance of current and anticipated scientific procedures, and the efficient utilization of space and resources.

These Room Data Sheets are intended to provide common requirements and characteristics of typical laboratory room types. They are intended to be a guide, which will be confirmed by designers and room users, and tailored to the specific programs for which they will be used.

### Acronyms:

ABSL	Animal Biosafety Level
ACT	Acoustic Ceiling Tile
AHJ	Authority Having Jurisdiction
BSC	Biological Safety Cabinet
BSL	Biosafety Level
CHW	Chilled Water
CMU	Concrete Masonry Unit
CW	Cold Water
FD	Floor Drain
FRP	Fiberglass Reinforced Panel
GFI	Ground Fault Interrupter
GWB	Gypsum Wall Board
HEPA	High-efficiency Particulate Arresting
HW	Hot Water
OA	Outside Air
PPE	Personal Protective Equipment
PW	Purified Water
RH	Relative Humidity
RO	Reverse Osmosis
VAC	Vacuum
VCT	Vinyl Composition Tile

## Lab Type: Laboratory Equipment

Project: \_\_\_\_\_ Room Name \_\_\_\_\_

WR Number: \_\_\_\_\_ Room Number: \_\_\_\_\_

Date: \_\_\_\_\_

1. Room Data		Other Special Requirements
a. Size/Dimensions	(1) module, 11' width	
b. BSL	BSL-2	
c. Ceiling height	2,896 mm (9'-6") minimum	
d. Door size	1,200 mm (4'-0")	Active leaf 900 mm (3'-0"); inactive leaf 300 mm (1'-0")
e. Door type	Painted steel, half-glass	Card key access control
f. Windows	Windows desirable	Blinds/light control required
g. Normal occupancy	0	
h. Special requirements		
2. Finishes		Other Special Requirements
a. Floor	VCT	
b. Base	Vinyl	
c. Wall type	GWB, painted	
d. Ceiling type	ACT	

3. Furnishings and Fittings		Other Special Requirements											
a. Casework	No												
b. Bench top	No												
c. Sink(s)	No												
d. Piped services	CO <sub>2</sub> for incubators – see equipment list												
e. Flammable storage cabinet	No												
f. Vented corrosive storage cabinet	No												
4. Equipment – See Equipment List for Additional Items		Other Special Requirements											
a. Biological safety cabinets	No												
b. Fume hoods	No												
5. HVAC Requirements		Other Special Requirements											
a. Temperature setpoint/range	Summer 23 +/-1°C (73 +/-2°F), Winter 21 +/-1°C (70 +/-2°F)	See equipment list for equipment heat load											
b. Humidity setpoint/range	Summer 50% +/-5 RH, Winter 30% +/-5 RH												
c. Temperature control	Independent												
d. Air filtration	30% pre-filter and 95% supply												
e. Relative pressure	Negative to corridor												
f. Air changes per hour	6 Minimum of 100% outside air												
g. Exhaust air	Yes												
6. Piping		CHW	CW	PW	HW	OTHER	CO <sub>2</sub>	AIR	VAC	GAS	WASTE	STEAM	FD
a. Utility	Yes	No	No	No	Condensate	Yes	No	No	No	No	No	No	No
b. Other	Chilled water may be required for supplemental cooling												
7. Electrical		Other Special Requirements											
a. Power receptacles	Yes	General purpose NEMA 5-20R receptacles; see equipment list for specialty receptacle requirements											
b. Lighting	Lab standard lighting												
c. Telephone/Communication	No												
d. Data/Computer	No												
e. Emergency power	Yes	Emergency power for equipment per equipment list											
f. Task lighting	No												
g. Other	Equipment monitoring may be required												

## Lab Type: Autoclave

Project:

Room Name

WR Number:

Room Number:

Date:

1. Room Data		Other Special Requirements
a. Size/Dimensions	(1) module, 11' width	
b. BSL	BSL-2	
c. Ceiling height	2,896 mm (9'-6") minimum	
d. Door size	1,200 mm (4'-0")	Active leaf 900 mm (3'-0"); inactive leaf 300 mm (1'-0")
e. Door type	Painted steel, half-glass	Card key access control
f. Windows	No	
g. Normal occupancy	0	
h. Special requirements		Floor space for carts.; adequate space and access for servicing of autoclave mechanical systems
2. Finishes		Other Special Requirements
a. Floor	VCT	
b. Base	Vinyl	
c. Wall type	GWB, painted	
d. Ceiling type	ACT or GWB	Gasketed or sealed ceiling system appropriate for high-humidity
3. Furnishings and Fittings		Other Special Requirements
a. Casework	No	
b. Bench top	No	
c. Sink(s)	No	
d. Piped services	No	
e. Flammable storage cabinet	No	
f. Vented corrosive storage cabinet	No	
g. Other		
4. Equipment – See Equipment List for Additional Items		Other Special Requirements
a. Biological safety cabinets	No	
b. Fume hoods	No	
c. Other	Autoclave	Confirm specific equipment requirements; canopy exhaust hood for steam capture
5. HVAC Requirements		Other Special Requirements
a. Temperature setpoint/range	Summer 24 +/-1°C (75 +/-2°F), Winter 21 +/-1°C (70 +/-2°F)	Service area – not exceeding 32°C (90 deg F)
b. Humidity setpoint/range	Summer 50% +/-10 RH, Winter 30% +/-5 RH	
c. Temperature control	Independent	
d. Air filtration	30% pre-filter and 95% supply	
e. Relative pressure	Negative to corridor	
f. Air changes per hour	10 minimum of 100% outside air	
g. Exhaust air	Yes	Canopy exhaust above doors on clean and dirty side of autoclaves

6. Piping	CHW	CW	PW	HW	OTHER	CO <sub>2</sub>	AIR	VAC	GAS	WASTE	STEAM	FD
a. Utility	No	Yes	No	No		No	Yes	Yes	No	Yes	Yes	Yes
b. Other	Steam and condensate and drain as required by autoclave											
7. Electrical	Other Special Requirements											
a. Power receptacles	Yes				General purpose NEMA 5-20R receptacles in support space							
b. Lighting	Specialty lighting				UL damp listed fixtures in support space							
c. Telephone/Communication	No											
d. Data/Computer	No											
e. Emergency power	No											
f. Task lighting	No											



## Lab Type: Cold Room

Project:

Room Name

WR Number:

Room Number:

Date:

1. Room Data		Other Special Requirements
a. Size/Dimensions	(1) module, 11' width	Custom fabricated unit to fit in standard module
b. BSL	BSL-2	
c. Ceiling height	2,440 mm (8'-0") minimum	
d. Door size	1,905 mm (3'-0") minimum	
e. Door type	Vision panel	By unit vendor; insulated, sealed, self-closing
f. Windows	No	
g. Normal occupancy	0	
h. Special requirements		Provide floor depression if possible to eliminate ramp at door
2. Finishes		Other Special Requirements
a. Floor	By unit vendor	All finishes preinstalled with unit
b. Base	By unit vendor	
c. Wall type	By unit vendor	Provide filler panels between unit and adjacent walls
d. Ceiling type	By unit vendor	
3. Furnishings and Fittings		Other Special Requirements
a. Casework	By unit vendor	Stainless steel
b. Bench top	By unit vendor	Stainless steel
c. Sink(s)	No	
d. Piped services	No	
e. Flammable storage cabinet	No	
f. Vented corrosive storage cabinet	No	
g. Other		
4. Equipment – See Equipment List for Additional Items		Other Special Requirements
a. Biological safety cabinets	No	
b. Fume hoods	No	
c. Other	Confirm with program	See equipment list for any equipment to be installed in cold room
d. Other		
5. HVAC Requirements		Other Special Requirements
a. Temperature setpoint/range	4°C (39°F) or as determined by program	Range determined by program
b. Humidity setpoint/range	As determined by program	
c. Temperature control	Independent	
d. Air filtration	As determined by program	
e. Relative pressure	As determined by program	
f. Air changes per hour	As determined by program	Minimum OA required for occupants
g. Exhaust air	As determined by program	

6. Piping	CHW	CW	PW	HW	OTHER	CO <sub>2</sub>	AIR	VAC	GAS	WASTE	STEAM	FD
a. Utility	Yes	No	No	No	Condensate drain	No	No	No	No	No	No	
b. Other	Piping services as determined by program; CHW for water cooled condenser											
7. Electrical	Other Special Requirements											
a. Power receptacles	By unit vendor					General purpose NEMA 5-20R receptacles						
b. Lighting	By unit vendor					Utilize LED light fixtures						
c. Telephone/Communication	By unit vendor											
d. Data/Computer	By unit vendor											
e. Emergency power	Yes					Emergency power for unit, and for equipment per equipment list						
f. Task lighting	No											
g. Other	Fire alarm visual indication may be required; confirm with AHJ											
h. Other	Water detection system for flood prevention											
i. Other	Conduit seals for every conduit penetration											

## Lab Type: Cleanroom

Project:

Room Name

WR Number:

Room Number:

Date:

1. Room Data		Other Special Requirements
a. Size/Dimensions	(1) module, 11' width	Anteroom required for gowning with bench, PPE storage, waste bins
b. BSL	BSL-3	
c. Ceiling height	2,896 mm (9'-6") minimum	
d. Door size	1,200 mm (4'-0")	Active leaf 900 mm (3'-0"); inactive leaf 300 mm (1'-0")
e. Door type	Painted steel, half-glass	Card key access control; interlocked vestibule doors
f. Windows	Windows desirable	Blinds/light control required
g. Normal occupancy	0	
h. Special requirements	Confirm with program	All surfaces cleanable; sticky mats at entrance; all penetrations sealed
2. Finishes		Other Special Requirements
a. Floor	Seamless sheet vinyl	
b. Base	6" vinyl, integral with floor	
c. Wall type	GWB, painted	
d. Ceiling type	GWB, painted	Gasketed access panels where required
3. Furnishings and Fittings		Other Special Requirements
a. Casework	Stainless steel	Minimize casework to promote cleanliness; use tables and carts where possible
b. Bench top	Stainless Steel	
c. Sink(s)	No	
d. Piped services	No	
e. Flammable storage cabinet	Yes	
f. Vented corrosive storage cabinet	No	
g. Other		Minimize horizontal surfaces.
4. Equipment – See Equipment List for Additional Items		Other Special Requirements
a. Biological safety cabinets	(1) 6', class II, type A2	Vacuum in BSC
b. Fume hoods	No	
c. Other	Confirm with program	
d. Other		
5. HVAC Requirements		Other Special Requirements
a. Temperature setpoint/range	Summer 23 +/-1°C (73 +/-2°F), Winter 21 +/-1°C (70 +/-2°F)	Lower temperatures in summer as determined by program
b. Humidity setpoint/range	Summer 50% +/-5 RH, Winter 30% +/-5 RH	
c. Temperature control	Independent	
d. Air filtration	HEPA or as determined by program	
e. Relative pressure	Positive to anteroom	
f. Air changes per hour	As determined by class of cleanliness	
g. Exhaust air	Return air may be allowed if HEPA filtered	

6. Piping	CHW	CW	PW	HW	OTHER	CO <sub>2</sub>	AIR	VAC	GAS	WASTE	STEAM	FD
a. Utility	No	No	No	No	No Condensate	Yes	No	Yes	No	No	No	No
b. Other	Piping services as determined by program											
7. Electrical	Other Special Requirements											
a. Power receptacles	Yes				General purpose NEMA 5-20R receptacles							
b. Lighting	Specialty lighting				Lighting lensed, sealed, gasketed							
c. Telephone/Communication	Yes											
d. Data/Computer	Yes											
e. Emergency power	Yes				Emergency power for equipment per equipment list							
f. Task lighting	Yes											
g. Other	Electrical boxes and conduits sealed											

## Lab Type: Cage Wash

Project:

Room Name

WR Number:

Room Number:

Date:

1. Room Data		Other Special Requirements
a. Size/Dimensions	Determined by cage/rack throughput	
b. BSL	ABSL-2	
c. Ceiling height	2,896 mm (9'-6") minimum	
d. Door size	1,830 mm (6'-0")	(2) 915 mm (3'-0") doors.
e. Door type	FRP, half-glass	Stainless steel jambs, roller-type jamb guards, armor plates; consider hands-free automatic doors; swing in direction of travel
f. Windows	No	
g. Normal occupancy	1	
h. Special requirements		Extreme heat and humidity, wall protection, floor drains, adequate space for clean and dirty rack staging; pits, capture hood, utilities and other accommodations required for large equipment (cage washers, rack washers)
2. Finishes		Other Special Requirements
a. Floor	Epoxy	
b. Base	6" coved epoxy integral with floor	Sealed or lapped transition between top of base and wall
c. Wall type	Epoxy paint or FRP panel system	Smooth, monolithic surface, multiple coats of block filler for CMU walls
d. Ceiling type	Epoxy painted GWB	Materials, details appropriate for high humidity; gasketed access panels where required
3. Furnishings and Fittings		Other Special Requirements
a. Casework	No	Movable stainless steel furniture where required
b. Bench top	No	
c. Sink(s)	Large wash tub-type sink	Stainless steel
d. Piped services	No	
e. Flammable storage cabinet	No	
f. Vented corrosive storage cabinet	No	
g. Other	Confirm with program	Possible items: stainless steel mop rack, shelves, hose reels
4. Equipment – See Equipment List for Additional Items		Other Special Requirements
a. Biological safety cabinets	No	
b. Fume hoods	No	
c. Other	Cage washer, rack washer	See details on equipment list
d. Other	Confirm with program	Possible items: bedding dump station, bedding dispenser, bottle filler, autoclave, robotic loader/unloader

5. HVAC Requirements		Other Special Requirements											
a. Temperature setpoint/range	Summer 25.5 +/-2°C (78 +/-4°F), Winter 21 +/-2°C (70 +/-4°F)	Service area – not exceeding 32C (90 deg F)											
b. Humidity setpoint/range	Summer 50% +/-10 RH, Winter 30% +/-5 RH												
c. Temperature control	Independent												
d. Air filtration	30% pre-filter and 95% supply												
e. Relative pressure	Negative to corridor												
f. Air changes per hour	6 minimum of 100% outside air	Or as determined by exhaust											
g. Exhaust air	Yes												
6. Piping	CHW	CW	PW	HW	OTHER	CO <sub>2</sub>	AIR	VAC	GAS	WASTE	STEAM	FD	
a. Utility	Yes	Yes	No	Yes	No Condensate	No	Yes	No	No	Yes	Yes	Yes	
b. Other	Eyewash, emergency shower, hose bibb, other systems required by equipment												
7. Electrical		Other Special Requirements											
a. Power receptacles	Yes	GFI, gasketed, waterproof covers											
b. Lighting		UL wet listed fixture types rated IP65 or 85 psi											
c. Telephone/Communication	Telephone or telecom between clean and dirty sides												
d. Data/Computer	No												
e. Emergency power	No												
f. Task lighting	No												
g. Other	Power required by equipment												



## Lab Type: Biochemistry/Wet Lab

Project: Room Name

WR Number: Room Number:

Date:

1. Room Data		Other Special Requirements
a. Size/Dimensions	(1) module, 11' width	
b. BSL	BSL-2	
c. Ceiling height	2,896 mm (9'-6") minimum	
d. Door size	1,200 mm (4'-0")	Active leaf 900 mm (3'-0"); inactive leaf 300 mm (1'-0")
e. Door type	Painted steel, half-glass	Card key access control
f. Windows	Windows desirable	Blinds/light control required
g. Normal occupancy	2	Write-up space for 2 required
h. Special requirements		
2. Finishes		Other Special Requirements
a. Floor	VCT	
b. Base	Vinyl	
c. Wall type	GWB, painted	
d. Ceiling type	ACT	
3. Furnishings and Fittings		Other Special Requirements
a. Casework	Painted steel	Wall shelves
b. Bench top	Phenolic resin	
c. Sink(s)	(1) Deep sink for glassware washing	Shelf and connections for water polisher, pegboard
d. Piped services	Gas, vacuum, compressed air	(1) Set of services on each wall
e. Flammable storage cabinet	Required	
f. Vented corrosive storage cabinet	Required	
g. Other		
4. Equipment – See Equipment List for Additional Items		Other Special Requirements
a. Biological safety cabinets	No	
b. Fume hoods	(1) 4'	Confirm services, cupsink in fume hood; corrosive storage in base of hood
c. Other	Confirm with program	
5. HVAC Requirements		Other Special Requirements
a. Temperature setpoint/range	Summer 23 +/-1°C (73 +/-2°F), Winter 21 +/-1°C (70 +/-2°F)	
b. Humidity setpoint/range	Summer 50% +/-5 RH, Winter 30% +/-5 RH	
c. Temperature control	Independent	
d. Air filtration	30% pre-filter and 95% supply	
e. Relative pressure	Negative to corridor	
f. Air changes per hour	6	
g. Exhaust air	Yes	

6. Piping	CHW	CW	PW	HW	OTHER	CO <sub>2</sub>	AIR	VAC	GAS	WASTE	STEAM	FD
a. Utility	No	Yes	Yes	Yes	No Condensate	No	Yes	Yes	Yes	Yes	No	No
b. Other	RO water at sink and water polisher; eyewash at lab sink, emergency shower; CO <sub>2</sub> if required by program											
7. Electrical	Other Special Requirements											
a. Power receptacles	Yes					General purpose NEMA 5-20R receptacles, and specialty receptacles per equipment list						
b. Lighting	Lab standard lighting											
c. Telephone/Communication	Yes											
d. Data/Computer	Yes											
e. Emergency power	Yes					Emergency power for equipment per equipment list						
f. Task lighting	Yes											

## Lab Type: Tissue Culture

Project:

Room Name

WR Number:

Room Number:

Date:

1. Room Data		Other Special Requirements
a. Size/Dimensions	(1) module, 11' width	
b. BSL	BSL-2	
c. Ceiling height	2,896 mm (9'-6") minimum	
d. Door size	1,200 mm (4'-0")	Active leaf 900 mm (3'-0"); inactive leaf 300 mm (1'-0")
e. Door type	Painted steel, half-glass	Card key access control
f. Windows	Windows desirable	Blinds/light control required
g. Normal occupancy	2	
h. Special requirements		
2. Finishes		Other Special Requirements
a. Floor	VCT	
b. Base	Vinyl	
c. Wall type	GWB, painted	
d. Ceiling type	ACT	
3. Furnishings and Fittings		Other Special Requirements
a. Casework	Painted steel	Wall shelves
b. Bench top	Phenolic resin	
c. Sink(s)	(1) Small for hand washing	Shelf and connections for water polisher, pegboard
d. Piped services	Vacuum, compressed air	(1) Set of services on each wall
e. Flammable storage cabinet	Required	
f. Vented corrosive storage cabinet	No	
4. Equipment – See Equipment List for Additional Items		Other Special Requirements
a. Biological safety cabinets	(2) 4', class II, type A2	Vacuum in BSC
b. Fume hoods		
c. CO <sub>2</sub> incubator	(2) Stacked	
d. Other	Cylinder restraints and piping for CO <sub>2</sub> if there is no central system	
5. HVAC Requirements		Other Special Requirements
a. Temperature setpoint/range	Summer 23 +/-1°C (73 +/-2°F), Winter 21 +/-1°C (70 +/-2°F)	
b. Humidity setpoint/range	Summer 50% +/-5 RH, Winter 30% +/-5 RH	
c. Temperature control	Independent	
d. Air filtration	30% pre-filter and 95% supply	
e. Relative pressure	Negative to corridor	
f. Air changes per hour	6 minimum 100% outside air	
g. Exhaust air	Yes	

6. Piping	CHW	CW	PW	HW	OTHER	CO <sub>2</sub>	AIR	VAC	GAS	WASTE	STEAM	FD
a. Utility	No	Yes	Yes	Yes	No Condensate	Yes	Yes	Yes	No	Yes	Yes	Yes
b. Other	No fan coils in tissue culture room; eyewash at sink											
7. Electrical	Other Special Requirements											
a. Power receptacles	Yes					General purpose NEMA 5-20R receptacles						
b. Lighting	Lab standard lighting					Lensed, sealed, gasketed fixtures						
c. Telephone/Communication	Yes											
d. Data/Computer	Yes											
e. Emergency power	Yes					Emergency power for equipment per equipment list						
f. Task lighting	Yes											

## Lab Type: Small Animal Procedure

Project: Room Name

WR Number: Room Number:

Date:

1. Room Data		Other Special Requirements
a. Size/Dimensions	Determined by intended use	
b. BSL	ABSL-2	
c. Ceiling height	2,896 mm (9'-6") minimum	
d. Door size	1,200 mm (4'-0")	Confirm size with equipment to be moved
e. Door type	FRP, vision panel	Stainless steel armor plates
f. Windows	No	
g. Normal occupancy	0	
h. Special requirements		Low vibration and noise tolerance; confirm room characteristics; all openings, joints, coverplates, etc. sealed completely; aseptic
2. Finishes		Other Special Requirements
a. Floor	Epoxy	
b. Base	6" coved integral with floor	Sealed or lapped transition between top of base and wall
c. Wall type	Epoxy paint	Smooth, monolithic surface, multiple coats of block filler for CMU walls
d. Ceiling type	Epoxy painted GWB	Gasketed access panels where required
3. Furnishings and Fittings		Other Special Requirements
a. Casework	Stainless steel	Minimize casework to promote cleaning and decontamination
b. Bench top	Stainless steel	
c. Sink(s)	Hand washing sink	Hands free operation
d. Piped services	Confirm with program	
e. Flammable storage cabinet	No	
f. Vented corrosive storage cabinet	No	
g. Other		
4. Equipment – See Equipment List for Additional Items		Other Special Requirements
a. Biological safety cabinets	Confirm with program	
b. Fume hoods	No	
c. Other	Confirm with program	Possible items: downdraft table, BSC, microscope, refrigerator
d. Other		See details on equipment list
5. HVAC Requirements		Other Special Requirements
a. Temperature setpoint/range	Summer 23 +/-1°C (73+/-2°F), Winter 21 +/-1°C (70 +/-2°F)	
b. Humidity setpoint/range	Summer 50% +/-5 RH, Winter 30% +/-5 RH	
c. Temperature control	Independent	
d. Air filtration	30% pre-filter and 95% supply	
e. Relative pressure	Negative to corridor	
f. Air changes per hour	12 minimum of 100% outside air	
g. Exhaust air	Yes	Exhaust for down draft table if applicable

6. Piping	CHW	CW	PW	HW	OTHER	CO <sub>2</sub>	AIR	VAC	GAS	WASTE	STEAM	FD
a. Utility	No	Yes	Yes	No	Oxygen	Yes	Yes*	Yes*	No	Yes	No	No
b. Other	Eyewash; hose bib, hose reel and floor drain only if required by program; O <sub>2</sub> and CO <sub>2</sub> where applicable; *veterinary medical gas systems											
7. Electrical	Other Special Requirements											
a. Power receptacles	Yes					General purpose NEMA 5-20R receptacles and specialty receptacles; refer to equipment list						
b. Lighting	Specialty lighting					Lensed, sealed, and gasketed fixtures						
c. Telephone/Communication	Yes											
d. Data/Computer	Yes											
e. Emergency power	Yes					Emergency power for equipment per equipment list						
f. Task lighting	Yes											
g. Other												Exam light



## Lab Type: Small Animal Holding

Project:

Room Name

WR Number:

Room Number:

Date:

1. Room Data		Other Special Requirements
a. Size/Dimensions	Determined by rack number and size	Adequate clearances for moving racks, caring for animals
b. BSL	ABSL-2	
c. Ceiling height	2,896 mm (9'-6") minimum	
d. Door size	1,200 mm (4'-0")	Confirm size with racks to be moved
e. Door type	FRP, vision panel with cover	Stainless steel jambs, roller-type jamb guards, armor plates
f. Windows	No	
g. Normal occupancy	1-2	
h. Special requirements		Low vibration and noise tolerance; confirm room characteristics; all openings, joints, coverplates, etc. sealed completely; wall protection
2. Finishes		Other Special Requirements
a. Floor	Epoxy	
b. Base	6" covered epoxy integral with floor	Sealed or lapped transition between top of base and wall
c. Wall type	Epoxy paint	Smooth, monolithic surface, multiple coats of block filler for CMU walls
d. Ceiling type	Epoxy painted GWB	Gasketed access panels where required
3. Furnishings and Fittings		Other Special Requirements
a. Casework	No	Movable stainless steel furniture where required
b. Bench top	No	
c. Sink(s)	Wall-hung hand washing sink	
d. Piped services	No	
e. Flammable storage cabinet	No	
f. Vented corrosive storage cabinet	No	
g. Other	Confirm with program	Possible items: stainless steel mop rack, shelves, hose reel
4. Equipment – See Equipment List for Additional Items		Other Special Requirements
a. Biological safety cabinets	No	
b. Fume hoods	No	
c. Other	Cage changing station	See details on equipment list
d. Other	Cage racks	See details on equipment list

5. HVAC Requirements		Other Special Requirements											
a. Temperature setpoint/range	Summer 23 +/-1°C (73 +/-2°F), Winter 21 +/-1°C (70 +/-2°F)	Ceiling ports for ventilated cage racks											
b. Humidity setpoint/range	Summer 50% +/-5 RH, Winter 30% +/-5 RH												
c. Temperature control	Independent												
d. Air filtration	30% pre-filter and 95% supply												
e. Relative pressure	Negative to corridor												
f. Air changes per hour	10 to 15 of 100% outside air	10 air changes minimum for rooms with ventilated cage racks											
g. Exhaust air	Yes												
6. Piping		CHW	CW	PW	HW	OTHER	CO <sub>2</sub>	AIR	VAC	GAS	WASTE	STEAM	FD
a. Utility	No	Yes	No	Yes	No	Condensate	No	No	No	No	Yes	No	No
b. Other	Eyewash; hose bibb; automatic watering system												
7. Electrical		Other Special Requirements											
a. Power receptacles	Yes	NEMA 5-20R receptacles, gasketed, weatherproof											
b. Lighting	Specialty lighting	Lensed, sealed, and gasketed fixtures											
c. Telephone/Communication		Telephone may be required; confirm with program											
d. Data/Computer	Yes												
e. Emergency power	Yes	Emergency power for equipment per equipment list											
f. Task lighting	No												
g. Other		3-lamp fixtures for variable lighting levels with two ballasts required; confirm requirements with veterinary staff											
h. Other		Diurnal controls for circadian rhythm; confirm requirements with veterinary staff											

## Lab Type: Optics

Project:

Room Name

WR Number:

Room Number:

Date:

1. Room Data		Other Special Requirements
a. Size/Dimensions	(1) module, 11' width	
b. BSL	BSL-2	
c. Ceiling height	2,896 mm (9'-6") minimum	
d. Door size	1,200 mm (4'-0")	Active leaf 900 mm (3'-0"); inactive leaf 300 mm (1'-0")
e. Door type	Painted steel, no glass	Card key access control
f. Windows	Windows not desirable	Blinds/light control required
g. Normal occupancy	2	Write-up space for 2 required
h. Special requirements		Vibration sensitive equipment; confirm floor performance; may require vibration control in the form of isolation pad or other mediation
2. Finishes		Other Special Requirements
a. Floor	VCT	Matte black
b. Base	Vinyl	Matte black
c. Wall type	GWB, painted	Matte black
d. Ceiling type	ACT	Matte black
3. Furnishings and Fittings		Other Special Requirements
a. Casework	Painted steel	Matte black
b. Bench top	Phenolic Resin	Matte black
c. Sink(s)	(1) for hand washing	
d. Piped services	Vacuum, compressed air	(1) Set of services on each wall
e. Flammable storage cabinet	No	
f. Vented corrosive storage cabinet	No	
4. Equipment – See Equipment List for Additional Items		Other Special Requirements
a. Biological safety cabinets	No	
b. Fume hoods	No	
c. Other	Optics table, lasers, chiller for lasers, microscopes	See equipment list for requirements
5. HVAC Requirements		Other Special Requirements
a. Temperature setpoint/range	Summer 23 +/-1°C (73 +/-2°F), Winter 21 +/-1°C (70 +/-2°F)	Laminar flow at optics table
b. Humidity setpoint/range	Summer 50% +/-5 RH, Winter 30% +/-5 RH	
c. Temperature control	Independent	
d. Air filtration	30% pre-filter and 95% supply	
e. Relative pressure	Negative to corridor	
f. Air changes per hour	6 minimum of 100% outside air	
g. Exhaust air	Yes	Exhaust for laser blower where applicable

6. Piping	CHW	CW	PW	HW	OTHER	CO <sub>2</sub>	AIR	VAC	GAS	WASTE	STEAM	FD
a. Utility	Yes	Yes	Yes	Yes	Nitrogen	No	Yes	Yes	No	Yes	No	No
b. Other	Eyewash at lab sink, chilled water for laser chiller as applicable, compressed air or nitrogen for air table											
7. Electrical	Other Special Requirements											
a. Power receptacles	Yes				General purpose NEMA 5-20R receptacles; specialty receptacles per equipment list							
b. Lighting	Lab standard lighting				Variable lighting levels, including no light							
c. Telephone/Communication	Yes											
d. Data/Computer	Yes											
e. Emergency power	No				Emergency power for equipment per equipment list							
f. Task lighting	Yes											
g. Other	Door interlock controls for power supply shutdown in the event of entry during operations; illuminated 'in-use' sign											

## Lab Type: Microbiology

Project:

Room Name

WR Number:

Room Number:

Date:

1. Room Data		Other Special Requirements
a. Size/Dimensions	(1) module, 11' width	
b. BSL	BSL-2	
c. Ceiling height	2896 mm (9'-6") minimum	
d. Door size	1,200 mm (4'-0")	Active leaf 900 mm (3'-0"); inactive leaf 300 mm (1'-0")
e. Door type	Painted steel, half-glass	Card key access control
f. Windows	Windows desirable	Blinds/light control required
g. Normal occupancy	2	Write-up space for 2 required
h. Special requirements		
2. Finishes		Other Special Requirements
a. Floor	VCT	
b. Base	Vinyl	
c. Wall type	GWB, painted	
d. Ceiling type	ACT	
3. Furnishings and Fittings		Other Special Requirements
a. Casework	Painted steel	Wall shelves
b. Bench top	Phenolic Resin	
c. Sink(s)	(1) deep sink for glassware washing	Shelf and connections for water polisher, pegboard
d. Piped services	Vacuum, compressed air	(1) Set of services on each wall
e. Flammable storage cabinet	Required	
f. Vented corrosive storage cabinet	Required	
4. Equipment – See Equipment List for Additional Items		Other Special Requirements
a. Biological safety cabinets	(1) 6', class II, type A2	Vacuum in BSC
b. Fume hoods	(1) 4'	
c. Other	Confirm with program	
5. HVAC Requirements		Other Special Requirements
a. Temperature setpoint/range		Summer 23 +/-1°C (73 +/-2°F); Winter 21 +/-1°C (70 +/-2°F)
b. Humidity setpoint/range		Summer 50% +/-5 RH, Winter 30% +/-5 RH
c. Temperature control		Independent
d. Air filtration		30% pre-filter and 95% supply
e. Relative pressure		Negative to corridor
f. Air changes per hour		6 minimum of 100% outside air
g. Exhaust air		Yes

6. Piping	CHW	CW	PW	HW	OTHER	CO <sub>2</sub>	AIR	VAC	GAS	WASTE	STEAM	FD
a. Utility	No	Yes	Yes	Yes		Yes	Yes	Yes	No	Yes	No	No
b. Other	Pure water at sink and water polisher; eyewash at lab sink, emergency shower, CO <sub>2</sub> for incubators											
7. Electrical	Other Special Requirements											
a. Power receptacles	Yes					General purpose NEMA 5-20R receptacles; specialty receptacles per equipment list						
b. Lighting	Lab standard lighting											
c. Telephone/Communication	Yes											
d. Data/Computer	Yes											
e. Emergency power	Yes					Emergency power for equipment per equipment list						
f. Task lighting	Yes											



## Lab Type: Lab Supply Room

Project:

Room Name

WR Number:

Room Number:

Date:

1. Room Data		Other Special Requirements
a. Size/Dimensions	(1) module, 11' width	
b. BSL	BSL-2	
c. Ceiling height	2896 mm (9'-6") minimum	
d. Door size	1200 mm (4'-0")	Active leaf 900 mm (3'-0"); inactive leaf 300 mm (1'-0")
e. Door type	Painted steel	Card key access control
f. Windows	Windows not desirable	
g. Normal occupancy	0	
h. Special requirements		
2. Finishes		Other Special Requirements
a. Floor	VCT	
b. Base	Vinyl	
c. Wall type	GWB, painted	
d. Ceiling type	ACT	
3. Furnishings and Fittings		Other Special Requirements
a. Casework	Painted steel	Storage cabinets and wall shelves
b. Bench top	No	
c. Sink(s)	No	
d. Piped services	No	
e. Flammable storage cabinet	No	
f. Vented corrosive storage cabinet	No	
g. Other		
4. Equipment – See Equipment List for Additional Items		Other Special Requirements
a. Biological safety cabinets	No	
b. Fume hoods	No	
c. Other		
d. Other		
5. HVAC Requirements		Other Special Requirements
a. Temperature setpoint/range	Summer 23 +/-1°C (73 +/-2°F), Winter 21 +/-1°C (70 +/-2°F)	
b. Humidity setpoint/range	Summer 50% +/-5 RH, Winter 30% +/-5 RH	
c. Temperature control	Independent	
d. Air filtration	30% pre-filter and 95% supply	
e. Relative pressure	Negative to corridor	
f. Air changes per hour	6 minimum of 100% outdoor air	
g. Exhaust air	Yes	

<b>6. Piping</b>	<b>CHW</b>	<b>CW</b>	<b>PW</b>	<b>HW</b>	<b>OTHER</b>	<b>CO<sub>2</sub></b>	<b>AIR</b>	<b>VAC</b>	<b>GAS</b>	<b>WASTE</b>	<b>STEAM</b>	<b>FD</b>
a. Utility	No	No	No	No	No	No	No	No	No	No	No	No
b. Other												
<b>7. Electrical</b>	<b>Other Special Requirements</b>											
a. Power receptacles	Yes					General purpose NEMA 5-20R receptacles						
b. Lighting	Lab standard lighting											
c. Telephone/Communication	No											
d. Data/Computer	No											
e. Emergency power	No											
f. Task lighting	No											

## Lab Type: Gowning BSL-3

Project:

Room Name

WR Number:

Room Number:

Date:

1. Room Data		Other Special Requirements
a. Size/Dimensions	(1) module, 11' width	Can act as an ante room
b. BSL	BSL-3	
c. Ceiling height	2896 mm (9'-6") minimum	
d. Door size	1,200 mm (4'-0")	Confirm requirements of equipment
e. Door type	Painted steel, half-glass	Card key access control; interlocked vestibule doors; power hands-free may be required; confirm with program
f. Windows	Windows desirable	Blinds/light control required
g. Normal occupancy	0	
h. Special requirements	Confirm with program	All openings, joints, coverplates, etc. thoroughly sealed
2. Finishes		Other Special Requirements
a. Floor	Seamless sheet vinyl	
b. Base	6" vinyl, integral with floor	
c. Wall type	GWB, painted	
d. Ceiling type	GWB, painted	Gasketed access panels where required
3. Furnishings and Fittings		Other Special Requirements
a. Casework	No	
b. Bench top	No	
c. Sink(s)	(1) Hand washing sink	Hands-free operation required
d. Piped services	No	
e. Flammable storage cabinet	No	
f. Vented corrosive storage cabinet	No	
g. Other		Shelves or cabinets for PPE storage; bins for PPE disposal; bench; lockers
4. Equipment – See Equipment List for Additional Items		Other Special Requirements
a. Biological safety cabinets	No	
b. Fume hoods	No	
c. Other	No	

5. HVAC Requirements		Other Special Requirements											
a. Temperature setpoint/range	Summer 23 +/-1°C (73 +/-2°F), Winter 21 +/-1°C (70 +/-2°F)												
b. Humidity setpoint/range	Summer 50% +/-5 RH, Winter 30% +/-5 RH												
c. Temperature control	Independent	Requires supply and exhaust terminal boxes											
d. Air filtration	30% pre-filter and 95% supply												
e. Relative pressure	Negative to corridor, positive to BSL-3 lab	Minimum of 0.05" wg, pressure monitors are required											
f. Air changes per hour	6 minimum of 100% outside air												
g. Exhaust air	Yes												
6. Piping	CHW	CW	PW	HW	OTHER	CO <sub>2</sub>	AIR	VAC	GAS	WASTE	STEAM	FD	
a. Utility	No	Yes	No	Yes	No Condensate	No	No	No	No	Yes	No	No	
b. Other	Eyewash at lab sink, emergency shower; water supply protected by backflow preventer, deep seal trap												
7. Electrical		Other Special Requirements											
a. Power receptacles	Yes	General purpose NEMA 5-20R receptacles											
b. Lighting	Lab standard lighting	Lensed, sealed, gasketed fixtures											
c. Telephone/Communication	Yes												
d. Data/Computer	Yes												
e. Emergency power	No												
f. Task lighting	No												
g. Other	Electronic door interlock, power-operated doors if required, power for hands-free faucets												
h. Other	Monitoring panels for differential pressurization												

## Lab Type: Electron Microscope

Project:

Room Name

WR Number:

Room Number:

Date:

1. Room Data		Other Special Requirements
a. Size/Dimensions	(1) module, 11' width	
b. BSL	BSL-2	
c. Ceiling height	3,050 mm (10'-0") (confirm)	Confirm installation and maintenance requirements, especially for microscope tower
d. Door size	1,200 mm (4'-0")	Active leaf 900 mm (3'-0"); inactive leaf 300 mm (1'-0")
e. Door type	Painted steel, half-glass	Card key access control
f. Windows	Program driven	Blinds/light control required
g. Normal occupancy	1	
h. Special requirements		Isolated slab for vibration control, separate room for chiller and other equipment
2. Finishes		
a. Floor	VCT	
b. Base	Vinyl	
c. Wall type	GWB, painted	
d. Ceiling type	ACT	
3. Furnishings and Fittings		
a. Casework	No	
b. Bench top	No	
c. Sink(s)	No	
d. Piped services	No	
e. Flammable storage cabinet	No	
f. Vented corrosive storage cabinet	No	
4. Equipment – See Equipment List for Additional Items		
a. Biological safety cabinets	No	
b. Fume hoods	No	
c. Other	Electron microscope and support equipment	See equipment cut sheets for requirements

5. HVAC Requirements													
a. Temperature setpoint/range	Summer 23 +/- 1°C (73 +/-2°F), Winter 21 +/-1°C (70 +/-2°F)			Temperature and range vary with type of microscope; lower temperature and tighter range for high end microscopes									
b. Humidity setpoint/range	Summer 50% +/-5 RH, Winter 30% +/-5 RH												
c. Temperature control	Independent												
d. Air filtration	30% pre-filter and 95% supply												
e. Relative pressure	Negative to corridor												
f. Air changes per hour	6 minimum of 100% outside air			Laminar air flow above microscope; air velocities per program requirements									
g. Exhaust air	Yes												
6. Piping													
	CHW	CW	PW	HW	OTHER	CO <sub>2</sub>	AIR	VAC	GAS	WASTE	STEAM	FD	
a. Utility	No	No	No	No	No	No	Yes	No	No	No	No	No	No
b. Other	Chilled water for local chiller if required; specialized gases as required per program												
7. Electrical													
a. Power receptacles	Yes			General purpose NEMA 5-20R receptacles									
b. Lighting	Lab standard lighting			Variable light levels (dimnable), non-fluorescent lighting may be required, additional lighting controls may be required; confirm dimnable range and requirements with facility users									
c. Telephone/Communication	Yes												
d. Data/Computer	Yes												
e. Emergency power	No												
f. Task lighting	No												
g. Other	Clean power for microscope and other equipment												



## Lab Type: Dark Room

Project:

Room Name

WR Number:

Room Number:

Date:

1. Room Data		Other Special Requirements
a. Size/Dimensions	(1) module, 11' width	
b. BSL	BSL-2	
c. Ceiling height	2,896 mm (9'-6") minimum	
d. Door size	Specialty door	
e. Door type	Revolving darkroom door	
f. Windows	No	
g. Normal occupancy	1	
h. Special requirements		Room to be completely darkened; corrosion resistant finishes, silver recovery
2. Finishes		Other Special Requirements
a. Floor	VCT	Matte black
b. Base	Vinyl	Matte black
c. Wall type	GWB, painted	Matte black
d. Ceiling type	ACT	Matte black
3. Furnishings and Fittings		Other Special Requirements
a. Casework	Phenolic resin	Corrosion resistant
b. Bench top	Phenolic Resin	Corrosion resistant
c. Sink(s)	(1) deep sink	Silver recovery system
d. Piped services	No	
e. Flammable storage cabinet	No	
f. Vented corrosive storage cabinet	Yes	
4. Equipment - See Equipment List for Additional Items		Other Special Requirements
a. Biological safety cabinets	No	
b. Fume hoods	No	
c. Other	Confirm with program	Possible item: automatic film processor
5. HVAC Requirements		Other Special Requirements
a. Temperature setpoint/range	Summer 23 +/-1°C (73 +/-2°F), Winter 21 +/-1°C (70 +/-2°F)	
b. Humidity setpoint/range	Summer 50% +/-5 RH, Winter 30% +/-5 RH	
c. Temperature control	Independent	
d. Air filtration	30% pre-filter and 95% supply	
e. Relative pressure	Negative to corridor	
f. Air changes per hour	6 minimum 100% outside air	
g. Exhaust air	Yes	

6. Piping	CHW	CW	PW	HW	OTHER	CO <sub>2</sub>	AIR	VAC	GAS	WASTE	STEAM	FD
a. Utility	No	Yes	No	Yes	No Condensate	No	Yes	Yes	No	Yes	No	Yes
b. Other	Eyewash, silver recovery											
7. Electrical	Other Special Requirements											
a. Power receptacles	Yes				General purpose NEMA 5-20R receptacles; specialty receptacles per equipment list							
b. Lighting	Specialty lighting				Ambient lighting and filtered incandescent lighting on single pole double throw switch. "In Use" light; confirm requirements with room users							
c. Telephone/Communication	No											
d. Data/Computer	No											
e. Emergency power	No											
f. Task lighting	No											
g. Other												

# Appendix G

## Sample Equipment Schedule

Project: \_\_\_\_\_ Room Name: \_\_\_\_\_  
 WR Number: \_\_\_\_\_ Room Number: \_\_\_\_\_  
 Date: \_\_\_\_\_

Note: This schedule is intended to provide basic equipment parameters for planning purposes. Additional schedules addressing specific utility requirements, connection requirements and other details unique to each discipline are typically required and shall be provided in individual discipline documentation.

Equipment Schedule														
Room name and number	Qty.	Existing (E) or New (N)	Description	Make & Model Number	Dimensions (inches)***	Power Requirement			Heat Output -BTU/HR		(CF/CI), (GF/GI) (GF/CI)*	Remarks - Special Requirements**	Owned By/ Maintained By****	
						Volts	Phase	Wattage	Receptacle	Emergency				Standing
1 Laboratory A	2	N	CO <sub>2</sub> Incubator	Thermo Scientific 3310	48 x 36 x 48	115	1		NEMA 5-15P		848	GF/CI	Stacked; CO <sub>2</sub> required	
2 Laboratory A	1	E	Undercounter refrigerator	Helmer iLR105	24 x 27 x 34	115	1		NEMA 5-15P			GF/GI		
3 Laboratory A	1	N	Refrigerated Centrifuge	Thermo Scientific KR4i	31 x 35 x 37	208	1		NEMA 6-30P			GF/GI		
4														
5														
6														
7														
8														
9														
10														
11														
12														
13														
14														
15														
16														
17														
18														
19														
20														

\*CF/CI: Contractor Furnish/Contractor Install; GF/GI: Government Furnish/Government Install; GF/GI: Government Furnish/Contractor Install  
 \*\*Provide unusual or unique requirements and design considerations including weight, shielding, sensitivities, vibration production, services, utilities, exhaust, hazards, etc. Attach additional information including equipment specifications and cut sheets as required.  
 \*\*\*Provide dimensions appropriate for the project. See Appendix E: A/E Submission Requirements.  
 \*\*\*\*Information provided by Project Officer.

# Appendix H

## DRM Links

---

## H.1 Links to References on the World Wide Web

Names and Web site addresses are subject to change and are believed to be accurate and up to date as of the date of this release of the NIH *DRM*.

Abbreviation	Title of Standard or Regulatory Organization and Web Site
ABAAS	Architectural Barriers Act Accessibility Standard (ABAAS) <a href="http://www.access-board.gov">www.access-board.gov</a>
CFR	<b>Code of Federal Regulations:</b> Available from the Government Publishing Office <a href="http://www.ecfr.gov/cgi-bin/ECFR?page=browse">http://www.ecfr.gov/cgi-bin/ECFR?page=browse</a>
BMBL	<b>CDC/NIH Biosafety in Microbiological and Biomedical Laboratories:</b> Available in hard copy from the U.S. Government Publishing Office or online from the Centers for Disease Control and Prevention <a href="http://www.cdc.gov/biosafety/publications/bmbl5/">http://www.cdc.gov/biosafety/publications/bmbl5/</a>
Guide	<b>Guide for the Care and Use of Laboratory Animals:</b> Available from the National Academies Press <a href="http://www.nap.edu/catalog/5140.html">www.nap.edu/catalog/5140.html</a>

## H.2 Links to Industry Associations

Abbreviation	Title of Organization or Industry Association and Web Site
AA	Aluminum Association, Inc. (The) <a href="http://www.aluminum.org">http://www.aluminum.org</a>
AABC	Associated Air Balance Council <a href="http://www.aabc.com">http://www.aabc.com</a>
AAMA	American Architectural Manufacturers Association <a href="http://www.aamanet.org">http://www.aamanet.org</a>
ACGIH	American Conference of Governmental Industrial Hygienists <a href="http://www.acgih.org">www.acgih.org</a>
ACI	American Concrete Institute/ACI International <a href="http://www.aci-int.org">http://www.aci-int.org</a>
ACPA	American Concrete Pipe Association <a href="http://www.concrete-pipe.org">http://www.concrete-pipe.org</a>
AEIC	Association of Edison Illuminating Companies, Inc. (The) <a href="http://www.aeic.org">http://www.aeic.org</a>
AF&PA	American Forest & Paper Association <a href="http://www.afandpa.org">http://www.afandpa.org</a>
AGA	American Gas Association <a href="http://www.aga.org">http://www.aga.org</a>
AHA	American Hospital Association <a href="http://www.aha.org">http://www.aha.org</a>
AIA	American Institute of Architects (The) <a href="http://www.aia.org">www.aia.org</a>



<b>Abbreviation</b>	<b>Title of Organization or Industry Association and Web Site</b>
AISC	American Institute of Steel Construction <a href="http://www.aisc.org">www.aisc.org</a>
AITC	American Institute of Timber Construction <a href="http://www.aitc-glulam.org">www.aitc-glulam.org</a>
AMCA	Air Movement and Control Association International, Inc. <a href="http://www.amca.org">www.amca.org</a>
ANSI	American National Standards Institute <a href="http://www.ansi.org">www.ansi.org</a>
APA	Architectural Precast Association <a href="http://www.archprecast.org">www.archprecast.org</a>
API	American Petroleum Institute <a href="http://www.api.org">www.api.org</a>
ARI	Air Conditioning & Refrigeration Institute <a href="http://www.ahrinet.org">www.ahrinet.org</a>
ASCE	American Society of Civil Engineers <a href="http://www.asce.org">www.asce.org</a>
ASHE	American Society of Healthcare Engineering <a href="http://www.ashe.org">www.ashe.org</a>
ASHRAE	American Society of Heating, Refrigerating and Air Conditioning Engineers <a href="http://www.ashrae.org">www.ashrae.org</a>
ASME	ASME International (The American Society of Mechanical Engineers International) <a href="http://www.asme.org">www.asme.org</a>
ASPE	American Society of Plumbing Engineers <a href="http://www.aspe.org">www.aspe.org</a>
ASSE	American Society of Sanitary Engineering <a href="http://www.asse-plumbing.org">www.asse-plumbing.org</a>
ASTM	ASTM International (American Society for Testing and Materials International) <a href="http://www.astm.org">www.astm.org</a>
AWI	Architectural Woodwork Institute <a href="http://www.awinet.org">www.awinet.org</a>
AWS	American Welding Society <a href="http://www.aws.org">www.aws.org</a>
AWWA	American Water Works Association <a href="http://www.awwa.org">www.awwa.org</a>
BIA	Brick Industry Association (The) <a href="http://www.bia.org">www.bia.org</a>
BSI	Building Stone Institute <a href="http://www.buildingstoneinstitute.org/">http://www.buildingstoneinstitute.org/</a>
CRSI	Concrete Reinforcing Steel Institute <a href="http://www.crsi.org">www.crsi.org</a>
FMG	FM Global (Formerly: FM – Factory Mutual System) <a href="http://www.fmglobal.com">www.fmglobal.com</a>

<b>Abbreviation</b>	<b>Title of Organization or Industry Association and Web Site</b>
ICEA	Insulated Cable Engineers Association, Inc. <a href="http://www.icea.net">www.icea.net</a>
IEC	International Electrotechnical Commission <a href="http://www.iec.ch">www.iec.ch</a>
IEEE	Institute of Electrical and Electronics Engineers, Inc. (The) <a href="http://www.ieee.org">www.ieee.org</a>
IESNA	Illuminating Engineering Society <a href="http://www.ies.org/">http://www.ies.org/</a>
ILI	Indiana Limestone Institute of America, Inc. <a href="http://www.iliai.com">www.iliai.com</a>
ISEA	International Safety Equipment Association <a href="http://www.safetyequipment.org">www.safetyequipment.org</a>
LEED	Leadership in Energy and Environmental Design Available from the U.S. Green Building Council <a href="http://www.usgbc.org">http://www.usgbc.org</a>
LPI	Lightning Protection Institute <a href="http://www.lightning.org">www.lightning.org</a>
MIA	Marble Institute of America <a href="http://www.marble-institute.com">www.marble-institute.com</a>
NAAMM	National Association of Architectural Metal Manufacturers <a href="http://www.naamm.org">www.naamm.org</a>
NBBI	National Board of Boiler and Pressure Vessel Inspectors <a href="http://www.nationalboard.org">www.nationalboard.org</a>
NBGQA	National Building Granite Quarries Association, Inc. <a href="http://www.nbgqa.com">www.nbgqa.com</a>
NCMA	National Concrete Masonry Association <a href="http://www.ncma.org">www.ncma.org</a>
NCPI	National Clay Pipe Institute <a href="http://www.ncpi.org">www.ncpi.org</a>
NCTA	National Cable & Telecommunications Association <a href="http://www.ncta.com">www.ncta.com</a>
NEBB	National Environmental Balancing Bureau <a href="http://www.nebb.org">www.nebb.org</a>
NECA	National Electrical Contractors Association <a href="http://www.necanet.org">www.necanet.org</a>
NEMA	National Electrical Manufacturers Association <a href="http://www.nema.org">www.nema.org</a>
NETA	International Electrical Testing Association <a href="http://www.netaworld.org">www.netaworld.org</a>
NFPA	National Fire Protection Association <a href="http://www.nfpa.org">www.nfpa.org</a>
NFRC	National Fenestration Rating Council <a href="http://www.nfrc.org">www.nfrc.org</a>

<b>Abbreviation</b>	<b>Title of Organization or Industry Association and Web Site</b>
NPCA	National Precast Concrete Association <a href="http://precast.org">http://precast.org</a>
NRCA	National Roofing Contractors Association <a href="http://www.nrca.net">www.nrca.net</a>
NSF	NSF International (National Sanitation Foundation International) <a href="http://www.nsf.org">www.nsf.org</a>
PCA	Portland Cement Association <a href="http://www.cement.org">http://www.cement.org</a>
PCI	Precast/Prestressed Concrete Institute <a href="http://www.pci.org">www.pci.org</a>
PDI	Plumbing & Drainage Institute <a href="http://www.pdionline.org">www.pdionline.org</a>
SEFA	Scientific Equipment and Furniture Association <a href="http://www.sefalabs.com/">http://www.sefalabs.com/</a>
SMACNA	Sheet Metal and Air Conditioning Contractors' National Association <a href="http://www.smacna.org">www.smacna.org</a>
SWI	Steel Window Institute <a href="http://www.steelwindows.com">www.steelwindows.com</a>
TIA/EIA	Telecommunications Industry Association/Electronic Industries Alliance <a href="http://www.tiaonline.org">www.tiaonline.org</a>
UL	Underwriters Laboratories Inc. <a href="http://www.ul.com">www.ul.com</a>
WWPA	Western Wood Products Association <a href="http://www.wwpa.org">www.wwpa.org</a>

### H.3 Links to Code Agencies

<b>Abbreviation</b>	<b>Title of Code Organization and Web Site</b>
ICC	International Code Council, Inc. (Formerly: CABO – Council of American Building Officials) <a href="http://www.iccsafe.org/">http://www.iccsafe.org/</a>

## H.4 Links to Federal, State, and Local Agencies

Abbreviation	Title of Federal Agency and Web Site
EPA	Environmental Protection Agency <a href="http://www.epa.gov">www.epa.gov</a>
FCC	Federal Communications Commission <a href="http://www.fcc.gov">www.fcc.gov</a>
FDA	Food and Drug Administration <a href="http://www.fda.gov">www.fda.gov</a>
GSA	General Services Administration <a href="http://www.gsa.gov">www.gsa.gov</a>
DHHS	Department of Health and Human Services <a href="http://www.dhhs.gov">www.dhhs.gov</a>
MCDOT	Montgomery County, MD, Department of Transportation <a href="http://www.montgomerycountymd.gov/dot/">http://www.montgomerycountymd.gov/dot/</a>
MDE	Maryland Department of the Environment <a href="http://www.mde.state.md.us/Pages/Home.aspx">http://www.mde.state.md.us/Pages/Home.aspx</a>
MDOT	Maryland Department of Transportation <a href="http://www.mdot.maryland.gov/">http://www.mdot.maryland.gov/</a>
NIBS	National Institute of Building Sciences <a href="http://www.nibs.org">www.nibs.org</a>
NIST	National Institute of Standards and Technology <a href="http://www.nist.gov">www.nist.gov</a>
OSHA	Occupational Safety and Health Administration <a href="http://www.osha.gov">www.osha.gov</a>
PEPCO	Potomac Electric Power Company <a href="http://www.pepco.com">www.pepco.com</a>
USPS	Postal Service <a href="http://www.usps.com">www.usps.com</a>
WSSC	Washington Suburban Sanitary Commission <a href="http://www.wssc.dst.md.us/index.cfm">http://www.wssc.dst.md.us/index.cfm</a>

## H.5 Links to Miscellaneous Publications and References

Title of Publications, References, and Web Site
College of American Pathologists <a href="http://www.cap.org">www.cap.org</a>
ENERGY STAR Products <a href="http://www.energystar.gov">www.energystar.gov</a>
Whole Building Design Guide <a href="http://www.wbdg.org">www.wbdg.org</a>

# Appendix I

## Abbreviations, Acronyms, and Units of Measure

## Abbreviations and Acronyms

The following list of abbreviations and acronyms is provided for the benefit of the reader.

### A

A/D – Analog to Digital  
 A/E – Architect and Engineer  
 ABSL – Animal Biosafety Level  
 AC – Alternating Current  
 ACH – Air Changes per Hour  
 AFF – Above Finish Floor  
 AHJ – Authority Having Jurisdiction  
 AHU – Air Handling Unit  
 AI – Analog Input  
 AM – As Manufactured  
 AO – Analog Output  
 APR – Air Pressure Resistant  
 APs – Access Points  
 ATC – Automatic Temperature Control  
 ATS – Automatic Transfer Switch  
 AV – Audio Visual  
 AWG – American Wire Gauge  
 AWG – Average Water Gauge  
 AWS – Animal-watering System

### B

BAS – Building Automation System  
 B&F – Building and Facilities  
 BCP – Breaker Control Panel  
 BFP – Backflow Prevention  
 BI – Binary Input  
 Bit – Binary Digit  
 BO – Binary Output  
 BOD – Basis of Design  
 BSC – Biological Safety Cabinet  
 BSL – Biosafety Level

### C

CA – Commissioning Agent  
 CAD – Computer-aided Design  
 CADD – Computer-aided Design and Drafting  
 CAN – Common Accounting Number  
 CAT – Computed Tomography  
 CAV – Constant Air Volume  
 CCC – Clinical Center Complex  
 CD-ROM – Compact Disk Read Only Memory  
 CEE – Central Elevator Electronics  
 CG – Compressed Gas  
 CFH – Cubic Feet per Hour  
 CGA – Compressed Gas Association  
 CHW – Chilled Water  
 CISO – Chief Information Security Officer  
 CIT – Center for Information Technology



**CMU** – Concrete Masonry Units  
**CNG** – Compressed Natural Gas  
**CO** – Contracting Officer  
**CO<sub>2</sub>** – Carbon Dioxide  
**COR** – Contracting Officer’s Representative  
**CPF** – Controlled Permeability Form  
**CPS** – Cycles per Second (Hertz)  
**CPT** – Control Power Transformer  
**CQM** – Construction Quality Management  
**CRF** – Capital Recovery Factor  
**CRI** – Color Rendering Index  
**CSA/CD** – Carrier Sense Access/Collision Detect(ion)  
**CT** – Current Transformer  
**CW** – Cold Water  
**Cx** – Commissioning

---

## **D**

**D&T** – Diagnostic and Treatment  
**DC** – Direct Current  
**DDC** – Distributive Digital Control  
**DDS** – Distribution Duct System  
**DGR** – Dedicated Ground Riser  
**DIL** – Dynamic Insertion Loss  
**DISS** – Diameter Index Safety System  
**DNA** – Deoxyribonucleic Acid  
**DRM** – Design Requirements Manual  
**DVD** – Digital Versatile Disc  
**DWV** – Drain Waste Vent

## **E**

**EDP** – Electronic Data Processing  
**EDDP** – Emergency Diesel Distribution Panel  
**EDP** – Emergency Distribution Panel  
**EF** – Exhaust Fan  
**EM** – Electron Microscope  
**EMC** – Electrical Metal Conduit  
**EMI** – Electromagnetic Interference  
**EMO** – External Manual Operator  
**EMR** – Elevator Machine Room  
**EMT** – Electric Metallic Tubing  
**EPR** – Ethylene-Propylene Rubber  
**ERP** – Effective Radiated Power  
**ESRS** – Electron Spin Resonance Spectroscopy  
**ETL** – Electronic Testing Laboratory  
**EtO** – Ethylene Oxide

---

## **F**

**FACS** – Fluorescence-Activated Cell Sorter  
**FCP** – Forest Conservation Plan  
**FD** – Fire Department  
**FF** – Floor Flatness  
**FFE** – Fixtures, Furniture and Equipment  
**FL** – Floor Levelness  
**FBM** – Facility Branch Manager  
**FRP** – Fiberglass Reinforced Polyester  
**FTE** – Full-time Equivalent

**G**

**GFCI** – Ground Fault Circuit Interrupter

**GFI** – Grand Fault Interrupting

**GW** – Grease Waste

**GWB** – Gypsum Wallboard

---

**H**

**HEPA** – High-Efficiency Particulate Air

**HID** – Human Interface Devices; or High Intensity Discharge

**HIR** – Halogen Infrared

**HOA** – Hands-Off-Automatic

**HVAC** – Heating Ventilation and Air Conditioning

**HW** – Hot Water

**HWR** – Hot Water Recirculating

---

**I**

**I/O** – Input/Output

**IAQ** – Indoor Air Quality

**IC** – Institute or Center

**ICU** – Intensive Care Unit

**IDC** – Initiating Device Circuits

**IDF** – Intermediate Distribution Frame

**IEC** – International Electro-technical Commission

**IED** – Intelligent Electronic Device

**IFC** – Industry Foundation Classes

**IMC** – Intermediate Metal Conduit

**K**

**KCMIL** – Thousand Circular Mils

---

**L**

**LA** – Laboratory Air

**LAN** – Local Area Network

**LCC** – Life Cycle Cost

**LCD** – Liquid Crystal Display

**LED** – Light-Emitting Diode

**LOD** – Limits of Disturbance

**LP** – Low Pressure

**LS** – Limit Switch

**LSC** – Life Safety Code

**LV** – Laboratory Vacuum

**LW** – Laboratory Waste

---

**M**

**MA** – Medical Air

**MBC** – Modular Building Controller

**MCB** – Main Circuit Breaker

**MCC** – Motor Control Centers

**MDF** – Main Distribution Frame

**MEP** – Mechanical/Electrical/Plumbing

**MG** – Medical Gas

**MH** – Metal Halide

**MLO** – Main Lugs Only

**MOU** – Memorandum of Understanding

**MOV** – Metal Oxide Varistor

**MPW** – Medical Pathologic Waste

**MR** – Magnetic Resonance

**MRI** – Magnetic Resonance Imaging

**MS** – Mass Spectrophotometry

**MSDS** – Manufacturer’s Safety Data Sheet

**MW** – Molecular Weight

---

## **N**

**NAC** – Notification Appliance Circuits

**NC** – Noise Criteria or Normally Closed (switch)

**NHP** – Non-Human Primates

**NIC** – Noise Isolation Class

**NMR** – Nuclear Magnetic Resonance

**NO** – Normally Open

**NRC** – Noise Reduction Coefficient

**NSF** – National Standards Format; Nuclear Storage Facility

**NTP** – Notice to Proceed

---

## **O**

**O&M** – Operation and Maintenance

**OA** – Office of Acquisition

**OD** – Office of Director

**ODBC** – Open Database Connectivity

**OLE DB** – Object Linking and Embedding Data Base

**OR** – Operating Room

**OS&Y** – Outside Stem and Yoke

**OSI** – Open System Interconnection

**OSP** – Outside Plant

---

## **P**

**PAQ** – Perceived Air Quality

**PAR** – Post-anesthesia Recovery

**PC** – Personal Computer

**PCB** – Polychlorinated Biphenyl

**PCR** – Polymerase Chain Reaction

**PEPCO** – Potomac Electric Power Company

**PET** – Position Emission Tomography

**PF** – Power Factor

**PFA** – Perfluoroalkoxy

**PI** – Principal Investigator or Pulsed Input

**PILC** – Paper Insulated Lead Covered

**PIR** – Passive Infrared

**PIV** – Post Indicator Valve

**PLC** – Programmable Logic Controller

**PLF** – Plastic Laminate-Faced

**PO** – Project Officer

**POR** – Program of Requirements

**PPE** – Personal Protection Equipment

**PRV** – Pressure-reducing Valve

**PSDR** – Physical Security Design Requirements

**PT** – Potential Transformer

**PTFE** – Polytetrafluoroethylene

**PVC** – Polyvinyl Chloride

**PWL** – Power Level

**PWM** – Pulse-Width-Modulated Output

## Q

**QSM** – Quality Systems Manual

## R

**R** – Ratio or R-value

**RC** – Room Criteria

**RCR** – Room Cavity Ratio

**Re** – Reynolds Number

**RF** – Radio Frequency

**RFI** – Radio Frequency Interference

**RGBHV** – Red-Green-Blue-Horizontal-Vertical

**RGS** – Rigid Galvanized Steel

**RH** – Relative Humidity

**RO** – Reverse Osmosis

**ROM** – Read Only Memory

**RPZ** – Reduced Pressure Zone

**RTD** – Resistant Temperature Device

**RTU** – Remote Terminal Unit

## S

**SAN** – Sanitary Waste

**SAP** – Substation Automation Platform

**SCADA** – Supervisory Control and Data Acquisition

**SCFH** – Standard Cubic Feet per Hour

**SCR** – Silicone-Controlled Rectifier

**SCU** – Stand-alone Control Unit

**SD** – Storm Drainage

**SDR** – Standard Dimension Ratio

**SE** – Service Entrance

**SER** – Security and Emergency Response Services

**SFO** – Solicitation for Offer

**SHPO** – State Historic Preservation Officer

**SLC** – Signaling Line Circuits

**SM** – Smoke

**SMR** – Surface Metal Raceway

**SOG** – Slab on Grade

**SOW** – Scope of Work

**SPECT** – Single Photon Computerized Tomography

**SPF** – Specific-Pathogen Free

**STC** – Sound Transmission Class

**SYG** – Strong Yellow Green

## T

**TAB** – Testing and Balancing

**T&B** – Testing and Balancing

**TEC** – Terminal Equipment Controller

**TFN** – Thermoplastic fixture Wire Nylon Jacketed (UL)

**TGB** – Telecommunication Grounding Bus Bar

**THD** – Total Harmonic Distortion

**THHN** – Thermoplastic High Heat Resistant Nylon Coated

**THW** – Thermoplastic Heat and Water Resistant Insulated Wire (UL)

**THWN** – Thermoplastic Heat and Water Resistant

Nylon Coated

**TMGB** – Telecommunications Main Grounding Bus Bar

**TMMS** – Thermal Manual Motor Starter

**TVSS** – Transient Voltage Surge Suppression

---

## U

**UCP** – Unit Control Panel

**UDF** – Unit Directional Flow

**UFCP** – Urban Forest Conservation Plan

**UFCP** – Up Front Control Panel

**UL** – Underwriters Laboratories

**UPC** – Universal Programmable Controller

**UPS** – Uninterruptible Power Supply

**UPW** – Uniform Present Worth

**U/S** – Ultrasonic

**UTP** – Unshielded Twisted Pair

**UV** – Ultraviolet

---

## V

**V** – Volt

**VA** – Volt-ampere

**VAV** – Variable Air Volume

**VCT** – Vinyl Composition Tile

**VE** – Value Engineering

**VFD** – Variable Frequency Drive

**VGA** – Video Graphics Array

**VHF** – Very High Frequency

**VOC** – Volatile Organic Compound

**VPN** – Virtual Private Network

**VR** – Ventilation Rate

**VSD** – Variable Speed Drive

**VSI** – Voltage-Source Inverter

---

## W

**W/** – With

**WAN** – Wireless Area Network

**WAS** – Wide Area Services

**WLAN** – Wireless Local Area Network

**WXGA** – Wide Extended Graphic Array

---

## X

**XGA** – eXtended Graphics Array

**XHHW** – Cross Linked High Heat Water Resistant Insulated Wire (UL)

## Units of Measure

The following list of units of measure is provided for the benefit of the reader.

% – Percent	<b>g</b> – gram
° – Degrees	<b>gpm</b> – gallons per minute
°C – Degrees Celsius	<b>h</b> – hour
°F – Degrees Fahrenheit	<b>hp</b> – horsepower
°K – Degrees Kelvin	<b>Hz</b> – hertz
“ – Inch	<b>J</b> – Joule
‘ – Foot	<b>kg</b> – kilogram
± – Plus or Minus	<b>kHz</b> – kilohertz
≤ – Less than or equal to	<b>kJ</b> – kilojoule
< – Less than	<b>kPa</b> – kilopascal
≥ – Greater than or equal to	<b>kV</b> – kilovolt
> – Greater than	<b>kVA</b> – kilovolt-ampere
<b>μ</b> – micro	<b>kW</b> – kilowatt
<b>μm/s</b> – micrometers per second	<b>kWh</b> – kilowatt hour
<b>A</b> – ampere	<b>L</b> – liter
<b>C</b> – Coulomb (electric charge)	<b>L/s</b> – liters per second
<b>cd</b> – candela	<b>LPM</b> – liters per minute
<b>cfs</b> – cubic feet per second	<b>LPW</b> – lumens per watt
<b>cfm</b> – cubic feet per minute	<b>lux</b> – lux (Illuminance)
<b>cm</b> – centimeter	<b>m</b> – meter
<b>cph</b> – changes per hour	<b>m/s</b> – meters per second
<b>dB</b> – decibel	<b>m<sup>2</sup></b> – square meter
<b>dBa</b> – decibels acoustic	<b>mA</b> – milliamperere
<b>dBm</b> – decibel (referenced to milliwatts)	<b>Mbs</b> – megabits per second
<b>fps</b> – feet per second	<b>MCM</b> – thousand circular mils
<b>fpm</b> – feet per minute	<b>min</b> – minute
<b>ft<sup>2</sup></b> – square foot	<b>MJ</b> – megajoule
	<b>MHz</b> – megahertz
	<b>mL</b> – milliliter
	<b>mm</b> – millimeter



**mHz** – millihertz

**mol** – mole

**mRem** – millirem

**n** – nano

**N** – Newton (force)

**nm** – nanometer

**nm<sup>2</sup>** – nanometer squared

**Pa** – Pascal

**ppm** – parts per million

**psi** – pounds per square inch

**rad** – radian

**rpm** – revolutions per minute

**s** – second

**V** – volt

**VA** – volt-ampere

**W** – Watt

**yd<sup>3</sup>** – cubic yard

**Ω** – Ohm (electric resistance)

# Appendix J

## Lease Facilities *DRM* Checklist

The NIH *Design Requirements Manual (DRM)* establishes policy, design standards, and technical criteria for use in programming, designing, and constructing new buildings, and major and minor alterations for the NIH. This document applies to the design and construction for all NIH facilities nationwide, including those that are owned by the NIH and those that are leased by the Federal Government for use by the NIH. NIH grantees should refer to their Grants Officer for application of the *DRM* to specific construction grants.

Facility acquisitions include the purchase and/or lease of existing structures or facilities by the Federal Government. Existing facilities that are purchased and/or leased for use by NIH employees or which will house NIH equipment shall comply with all applicable Federal, National, State/local, and Departmental and Agency regulations and policies, including the *DRM*.

It is imperative that facilities acquired by lease for the NIH are capable of meeting all safety criteria and all other criteria that in any way could have an adverse effect on the health and/or safety of the building occupants or have an adverse effect on the integrity of ongoing research.

It is strongly advised that any proposed facility be evaluated for its capability to comply with the *DRM* prior to entering into a purchase or lease agreement.

Purchased or leased facilities whose intended function will be to conduct biomedical research shall be evaluated for their ability to provide flexible, adaptable, and expandable space. The extent to which the facility will adhere to the requirements outlined in the *DRM* should be reviewed by the NIH on a case-by-case basis. Elements such as the length of the lease term and future plans/programs of the occupants of the building should be considered in the review.

## Scope or Content

The procedure contains a checklist for each major design discipline to use in applying the *DRM* to leased facilities. For security requirements only, instead of a waiver checklist, a separate guideline was written for lease facilities. The *DRM* complies with the ISC Security Standards for Leased Space which were developed to provide a distinct set of standards specifically for leased locations mandated by HHS.

## Responsibilities

The contracting officer (CO) is responsible for verifying that the lease requires incorporation of the *DRM* and Lease Facility Checklist into all design and construction in the facility. The project officer (PO) is responsible for verification that this is done. The PO may delegate all or part of the work to others on the project team.

## Procedures

During the programming phase of each lease facility design and construction project, a representative of each design discipline on the project team shall review the *DRM* and the Leased Facility Checklist and note how and where it applies to the project.

Note that the Lease Facilities Checklist includes only those items that are waived. Every part of the *DRM* not listed in the “Guide Reference” column on the table applies to all NIH projects.

The Quality Assurance Plan on each lease facility design and construction project shall include verification that the requirements of the *DRM* and checklist have been met. A team that has experience with NIH lease facility projects may elect to only check once during the design. A team that has not done NIH work should have a more in depth plan.

### NIH *DRM* Leased Facility Waiver Checklist – Architectural (Chapters 2 & 4)

Instructions for use: This checklist includes only those items that are waived. Every part of the NIH *DRM* not listed on the table applies to all NIH projects. Where the table shows an “x” in the “all” column, the referenced paragraph is waived for any lease project regardless of the lease duration as described in the “description column”. For example, in the architectural sheet, for *DRM* reference, lease facilities in existing buildings are not required to conform to the thermal performance of windows, exterior doors, glazed panels and skylights. Because the description states existing facilities, new facilities would need to conform unless a variance is approved. Existing facilities would not need a variance when in non-conformance. In some cases the description summarizes or copies the part that is waived. For lines in the checklist where the “x” is in the “<=5” column, then the application is similar to that described above except that instead of waiving the requirement for all lease projects, these are only waived as described for leases that are 5 years or less. Likewise the “<=10” column are for waivers that only apply to leases with a 10 or less year duration.

Check Box	Lease Duration (Years)			Description
	<=5	<=10	All	
			X	Thermal Performance of Windows, Exterior Doors, Glazed Panels and Skylights – These performance standards are for new construction, existing facilities would not be able to comply.
			X	Operable Windows – Operable windows are not allowed in laboratory buildings and animal facilities.
			X	Glazing – These performance standards are for new construction; existing facilities would not be able to comply.
			X	Drywall Partitions – The <i>DRM</i> requires 18 G, 3 5/8” metal studs for wall construction. 22 G studs for wall construction are acceptable for office applications only.
			X	Finishes and Materials – Selection of finishes, materials, furniture and products are required to be made from the GSA Federal Supply Schedule. (office only)
			X	Lay-in Ceiling Tile - Standard calls for all ceiling tiles to be NIH standard. Many leased facilities have their own “standards.” Changing may not be cost-effective.
			X	Window Treatments – Standard calls for use of draperies and blinds, using neutral colors as a standard. Many leased facilities have their own “standards.” Changing may not be cost-effective.
			X	Signage – Standard calls for complying with the NIH Interior Signage Users Manual. Many leased facilities have their own “standards.” Also it calls for all interior and exterior signage to comply with ABAAS. Changing may not be cost-effective and if we were only leasing a portion of a facility, it would not be practical.
			X	Circulation Into and Within Buildings from Loading Dock – Standard calls for elevator lobbies and corridors adjacent to the loading dock: passageways in this area to have dual-level protective bumpers, wall, corner and door guards installed.
			X	Doors - These performance standards are for new construction; existing facilities would not be able to comply. These standards would add a great deal to the cost and would not be practical for a short term lease. This waiver does not apply to animal facilities or fire code requirements.
			X	Freight Elevators – The standard calls for the entrance to freight elevators to be from the materials-handling passageway, not from the building lobby. This may not be possible in existing facilities.
			X	Mortise Locksets and Lockset Trim – These standards are typical for NIH buildings, but are above what is typically installed in most leased spaces.
			X	Dock Protection

### NIH *DRM* Leased Facility Waiver Checklist – Civil Engineering (Chapter 3)

Instructions for use: This checklist includes only those items that are waived. Every part of the NIH *DRM* not listed on the table applies to all NIH projects. Where the table shows an “x” in the “all” column, the referenced paragraph is waived for any lease project regardless of the lease duration as described in the “description column”. For example, in the architectural sheet, for *DRM* reference, lease facilities in existing buildings are not required to conform to the thermal performance of windows, exterior doors, glazed panels and skylights. Because the description states existing facilities, new facilities would need to conform unless a variance is approved. Existing facilities would not need a variance when in non-conformance. In some cases the description summarizes or copies the part that is waived. For lines in the checklist where the “x” is in the “<=5” column, then the application is similar to that described above except that instead of waiving the requirement for all lease projects, these are only waived as described for leases that are 5 years or less. Likewise the “<=10” column are for waivers that only apply to leases with a 10 or less year duration.

Check Box	Lease Duration (Years)			Description
	<=5	<=10	All	
			X	Metric Standards – is not required for lease space
			X	Parking Lot Paving Materials
			X	Materials for Sidewalks, Curbs, Gutters
			X	Loading Dock Berths
			X	Screening; Visual
			X	Grading
			X	Landscaping
			X	Tree Types

### NIH *DRM* Leased Facility Waiver Checklist – Mechanical (Chapter 6 & 7)

Instructions for use: This checklist includes only those items that are waived. Every part of the NIH *DRM* not listed on the table applies to all NIH projects. Where the table shows an “x” in the “all” column, the referenced paragraph is waived for any lease project regardless of the lease duration as described in the “description column”. For example, in the architectural sheet, for *DRM* reference, lease facilities in existing buildings are not required to conform to the thermal performance of windows, exterior doors, glazed panels and skylights. Because the description states existing facilities, new facilities would need to conform unless a variance is approved. Existing facilities would not need a variance when in non-conformance. In some cases the description summarizes or copies the part that is waived. For lines in the checklist where the “x” is in the “<=5” column, then the application is similar to that described above except that instead of waiving the requirement for all lease projects, these are only waived as described for leases that are 5 years or less. Likewise the “<=10” column are for waivers that only apply to leases with a 10 or less year duration.

Check Box	Lease Duration (Years)			Description
	<=5	<=10	All	
X				Redundancy
			X	For comparison of systems, the life cycle shall be waived to 15 to 20 years for all lease applications.
			X	Use of duct lining prohibited
X				NIH enhanced system component identification
			X	Minimum Pipe Size requirements for Plumbing, HVAC and Fire Protection Systems
			X	Insulation – Enhanced application requirements for quality
			X	Insulation Material Thickness for equipment
			X	Material selection, size for piping insulation
			X	Air Plenums for air distribution not permitted at NIH
		X		Fume Hood Exhaust Based on the Fume Hood density Policy of the NIH
		X		Select Supply and Exhaust fan motors one size larger
X				Size supply and Exhaust Fans 20% greater air flow for future expansion
		X		Size supply and Exhaust branch air ducts for greater of the present air flow or 250 mm minimum duct diameter
		X		Thermostatic Traps with no by pass trap lines (not waived for cage wash, autoclave or other NIH maintained equipment)
X				Hazardous exhaust or special exhaust duct work shall be stainless steel
			X	Engine Exhaust System – residential and critical mufflers allowed at NIH due to noise concerns
			X	PRV stations design criteria and pressure-reducing valve selections
			X	Trap applications table for heating equipment and piping
			X	No by pass valve for steam trap, provide dual traps for redundancy
			X	Leaving water temperature from Chilled Water Plant
			X	All terminal coils and equipment shall be provided 2-way control valve
			X	Reverse return piping arrangement for better balancing results (waived for existing building only)



## NIH *DRM* Leased Facility Waiver Checklist – Plumbing (Chapters 8 & 12)

Instructions for use: This checklist includes only those items that are waived. Every part of the NIH *DRM* not listed on the table applies to all NIH projects. Where the table shows an “x” in the “all” column, the referenced paragraph is waived for any lease project regardless of the lease duration as described in the “description column”. For example, in the architectural sheet, for *DRM* reference D.2.3.1, lease facilities in existing buildings are not required to conform to the thermal performance of windows, exterior doors, glazed panels and skylights. Because the description states existing facilities, new facilities would need to conform unless a variance is approved. Existing facilities would not need a variance when in non-conformance. In some cases the description summarizes or copies the part that is waived. For lines in the checklist where the “x” is in the “<=5” column, then the application is similar to that described above except that instead of waiving the requirement for all lease projects, these are only waived as described for leases that are 5 years or less. Likewise the “<=10” column are for waivers that only apply to leases with a 10 or less year duration.

Check Box	Lease Duration (Years)			Description
	<=5	<=10	All	
			X	For comparison of systems, the life cycle shall be waived to 15 to 20 years for all lease applications.
		X		Modular lay out of piping system
			X	Each critical facility shall be provided with two separate water services from the campus loop
			X	Piping arrangement and valving should enable individual shutdown of each lab module.
			X	Double ended horizontal loop sectionalized for alteration and repairs
			X	Up feed of fixtures above is not permitted.
		X		Service run outs at regular intervals and at shafts valve and capped for future expansion and future connections for alterations
			X	Water treatment or softeners not required at NIH.
			X	Separate potable water loop preferred for Emergency eyewash and showers for each floor.
		X		Domestic potable hot water system heat exchanger is 20% larger than design demand for future expansion.
		X		Pipe mains shall be sized with 20% greater than calculated design flow.
		X		Water service main shall not be less than 200 mm in size at NIH.
			X	Requires double fed horizontal loop with separate risers serving each end for every wing of the building floor (waived for existing buildings only).
		X		Lab and Animal Facility waste and vent piping to be acid resistant. Enhanced installation details to ensure quality (waived for existing buildings only).
			X	Two way clean out for maintenance access from outside the building.
			X	Waste Discharge chart
		X		Enhanced gas system installation and testing requirements for safety and quality purposes (waived for existing facilities only.)
		X		Table Vivaria Gas Terminals for Animal Procedures
		X		Separate system from Lab air with 100% redundancy
		X		Enhanced equipment and installation requirements for reliability and quality
			X	Air distribution system for modular lab concept with valving and high pressure distribution riser and local pressure-reducing station at each floor for flexibility and isolation for maintenance
			X	Provide 20% excess capacity allowance for future allowance.

### NIH *DRM* Leased Facility Waiver Checklist – Fire Protection (Chapter 9)

Instructions for use: This checklist includes only those items that are waived. Every part of the NIH *DRM* not listed on the table applies to all NIH projects. Where the table shows an “x” in the “all” column, the referenced paragraph is waived for any lease project regardless of the lease duration as described in the “description column”. For example, in the architectural sheet, for *DRM* reference, lease facilities in existing buildings are not required to conform to the thermal performance of windows, exterior doors, glazed panels and skylights. Because the description states existing facilities, new facilities would need to conform unless a variance is approved. Existing facilities would not need a variance when in non-conformance. In some cases the description summarizes or copies the part that is waived. For lines in the checklist where the “x” is in the “<=5” column, then the application is similar to that described above except that instead of waiving the requirement for all lease projects, these are only waived as described for leases that are 5 years or less. Likewise the “<=10” column are for waivers that only apply to leases with a 10 or less year duration.

Check Box	Lease Duration (Years)			Description
	<=5	<=10	All	
			X	Local Authority Having Jurisdiction (AHJ) will determine level of conformance on partial renovation projects.
			X	Division of Fire Marshal in AHJ only if no local authority exists
			X	Only as required by local AHJ
			X	Dependent upon local AHJ
			X	Automatic extinguishing system can be used instead of 1 hour separation between boiler/furnace room and adjacent space.
			X	Reduction of shaft fire ratings in high-rise buildings with use of in-shaft sprinklers is not permitted.
			X	Main campus facilities with quantities of hazardous materials in excess of the exempt amounts identified in the IBC “Hazardous Materials”
			X	Spray-applied fireproofing shall be cementitious type or a gypsum based product only.
			X	Fire and Smoke Dampers (NFPA 90A): Fire Dampers shall be installed in locations where required by the IBC. The IBC requirements shall be modified to allow the omission of fire dampers in 1 hour-or-less fire-rated walls.
			X	Smaller modifications, renovations, and alterations (as defined in paragraph J.1.2) shall, whenever feasible, include the provision of capped-off sprinkler piping in the renovated areas to facilitate the future provision of sprinklers throughout the facility in order to implement NIH policy to provide sprinkler protection in all occupied facilities.
		X		The sprinkler pipe shall be Schedule 40 black steel or galvanized, except for installations where non-ferrous materials are required. Schedule 5, Schedule 10, “light wall” designated, or plastic sprinkler pipe is not permitted.
			X	Sprinkler system fittings shall meet the following requirements: Fittings into which sprinklers and sprinkler riser nipples are threaded shall be welded, threaded, or grooved-end type. Plain end fittings with mechanical couplings and fittings that use steel gripping devices to bite into the pipe when pressure is applied are not permitted.
			X	Where pendent sprinklers are installed on exposed piping (in areas with concrete ceilings), tee and elbows to which sprinklers are connected shall have one-inch outlets and shall be provided with 25 mm (1 in.) by 12 mm (0.5 in.) hexagon reducing bushings to permit connection of 25 mm (1 in.) drop nipples in the future.
			X	All concealed sprinkler piping and sprinkler piping in the stairwells, storage rooms, mechanical rooms, and utility rooms shall be painted red enamel. All other exposed sprinkler piping (outside of the stairwells) shall be painted to match the existing ceiling and red enamel bands 0.1 m wide shall be painted at 3.0 m intervals. In aesthetically sensitive areas, exposed sprinkler piping shall be painted to match the existing ceiling without red enamel bands. Valves, inspector test assemblies, low point drains, and auxiliary drains shall be provided with red enamel bands.

Check Box	Lease Duration (Years)			Description
	<=5	<=10	All	
			X	All new sprinkler systems shall have a central drain riser adjacent to the system riser, which shall be fully accessible to maintenance and safety personnel. With the exception of low point and auxiliary drains, all new system drain risers shall be hard piped to an approved exterior location or to a safe location inside the building which shall accept full water flow without causing property damage or a safety hazard.
			X	Quick-response type sprinklers are to be used throughout all NIH facilities, but standard-response type sprinklers shall be used in autoclave areas, electrical switchgear rooms, transformer rooms, electrical closets, freezers, cold rooms, and mechanical rooms.
			X	Waive minimum Ordinary Hazard, Group 1 requirement.
			X	Waive prohibition of sprinklers in elevator hoist ways and pits.
			X	Waive wall mounted and peninsula shelving height policy.
			X	Waive post indicator valve requirement.
			X	Waive prohibition of Class II and Class III standpipe systems.
			X	AHJ may require valves in standpipes at intermediate levels.
			X	Waive prohibition of pressure-reducing valves on standpipe systems.
			X	Fire Department Connections (NFPA's 13 and 14): At least one fire department connections (new building construction) shall be within 30.0 m of a fire hydrant. If any plan dimension of the building is greater than 46.0 m, then a second remote fire department connection shall be provided.
			X	Fire Hydrants (NFPA 24): A minimum of two hydrants shall be provided within 150 m of each building. All parts of the building exterior shall be reached by hose lays from at least one fire hydrant of not over 400 m with consideration given to accessibility and obstructions.
			X	Antifreeze systems are not permitted.
			X	Pre-action suppression systems are permitted only on a case-by case basis. Coordinate with NIH <i>DRM</i> Committee for selection and use.
			X	Heat trace tape is not permitted.
			X	Alternative agent suppression systems (water mist, Halon replacements) are only permitted on a case-by-case basis. Coordinate with NIH <i>DRM</i> Committee for selection and use.
			X	Fire Pumps (NFPA 20): Only electrically driven fire pumps shall be installed and shall be connected to an emergency power system (if available, see J.20 Fire Protection Emergency Power Requirements). The fire pump shall be sized to provide the most hydraulically most demanding sprinkler system. A separate hydraulic calculation for the standpipe risers and bulk mains shall be provided to demonstrate that NFPA 14 required fire hose valve flows can be met from fire apparatus connected to the building's Siamese connection. Assume a mobile fire apparatus supply of 1,500 gpm @ 200 psi.
			X	Waive key box requirement.
			X	If the fire protective signaling system includes an automatic smoke detection system, other than smoke detection required for elevator fire protection, then an addressable multiplex fire alarm system shall be provided. When an addressable multiplex fire alarm system is modified, the architects/engineers design documents shall include system reprogramming, modification of graphic interfaces, and updating of system as-built drawings.
			X	If the facility is considered a "high-rise building" in accordance with IBC, then an addressable multiplex fire alarm system shall be provided. The addressable multiplex shall be capable of transmitting a coded signal over a positive shunt non-interfering campus-wide McCulloh Loop system. The transmitting of the coded signal shall be an integral function of the addressable multiplex panel without the use of additional systems or foreign equipment. All fire alarm codes associated with the building fire alarm system shall be acquired from the NIH Fire Prevention Section.

Check Box	Lease Duration (Years)			Description
	<=5	<=10	All	
			X	All special purpose facilities that include animal facilities, health care occupancies, high-rise buildings, windowless structures, tunnels, and vaults shall be equipped with an addressable multiplex fire alarm system, fire department communication stations, and two-way occupant emergency communication. Upon an alarm, the fire alarm speakers are to sound a “slowwhoop” signal, at 90 to 110 dB, for four cycles, followed by a voice evacuation message. Upon completion of the voice message the slow-whoop shall resound and continue until the fire alarm control panel is reset or the “alarm silence” switch is activated. (This is not waived for animal facilities.)
			X	When voice communication systems are provided, at least two audio channels shall be provided. The audio channels shall be suitably supervised. Voice paging shall take priority over all automatic messages. The voice communication system shall be equipped with backup amplifier(s) such that the loss of any amplifier shall result in automatic switching to the backup amplifier(s). The system’s amplifier(s) shall be sized to accommodate the activation of all notification appliances. Adjustable volume levels for notification devices is required.
			X	Fire protective signaling systems shall have the following circuit supervision styles (NFPA 72): - All signaling line circuits (SLC) shall meet Style 6 requirements. - All panel-to-panel communication SLC circuits shall meet Style 7 requirements. - All initiating device circuits (IDC) shall meet Style D requirements. - All notification appliance circuits (NAC) shall meet Style Z requirements.
			X	All fire alarm wiring shall be installed in 19.05 mm (0.75 in.) minimum conduit or electrical metallic tubing (EMT). All fire alarms wiring in damp locations (fire pump and valve rooms, at flow, and tamper switches) shall be installed in liquid-tight flexible metal conduit and liquid-tight device boxes. Flexible metal conduit is limited to 1.83 m and shall be secured per National Electrical Code.
		X		All concealed fire alarm conduit and conduit located in the stairwells, storage rooms, mechanical rooms, garages, and utility rooms shall be painted red enamel. All other exposed fire alarm conduit (outside of the stairwells) shall be painted to match the existing adjacent wall surface, and red enamel bands 0.10 m wide shall be painted at 3.0 m intervals. This painting requirement also applies to the pull boxes, junction boxes, mounting boxes and extensions. Red enamel bands shall not be painted on the pull boxes, junction boxes, mounting boxes, and extensions. (In the case of box covers, this waiver does not apply. Box covers must be red.)
			X	General office areas are not to be equipped with smoke detection.
			X	The fire alarm wire for 120V AC circuits shall be #12 AWG, solid copper, TFN insulation. The fire alarm wire for 24V DC (or less) circuits shall be #16 AWG, solid copper, TFN insulation or solid copper cable in strict accordance with written equipment manufacturer’s requirements.
			X	All fire alarm systems shall be equipped with a 2 minute time delay, such that all “trouble” alarms are transmitted to the NIH Fire Department between 120 and 200 seconds after onset of the trouble condition occurs.
			X	Waive requirement for reporting to NIH campus wide fire alarm reporting system.
			X	Waive prohibition of duct smoke detectors.
			X	Waive requirement for recessed cabinet, the prohibition on cabinet locks and the prohibition of fire extinguisher in open garage.
			X	Waive class A requirement.
			X	Waive Class 1 requirement.
			X	Electrical Receptacles for Fire Department Use: Provide single receptacle NEMA L5-20R, twist-lock, 125V AC receptacles at each standpipe system connection within stairwells and at 30 m intervals in the exit access corridors at each level for the operation of fire department electrical equipment in the event of an emergency. The receptacles shall be provided with a red cover plate and be suitably identified by the following lettered designation “For Fire Department Use Only.”
			X	Prohibition of self luminous exit signs is waived.

## NIH *DRM* Leased Facility Waiver Checklist – Electrical (Chapters 10 & 11)

Instructions for use: This checklist includes only those items that are waived. Every part of the NIH *DRM* not listed on the table applies to all NIH projects. Where the table shows an “x” in the “all” column, the referenced paragraph is waived for any lease project regardless of the lease duration as described in the “description column”. For example, in the architectural sheet, for *DRM* reference, lease facilities in existing buildings are not required to conform to the thermal performance of windows, exterior doors, glazed panels and skylights. Because the description states existing facilities, new facilities would need to conform unless a variance is approved. Existing facilities would not need a variance when in non-conformance. In some cases the description summarizes or copies the part that is waived. For lines in the checklist where the “x” is in the “<=5” column, then the application is similar to that described above except that instead of waiving the requirement for all lease projects, these are only waived as described for leases that are 5 years or less. Likewise the “<=10” column are for waivers that only apply to leases with a 10 or less year duration.

Check Box	Lease Duration (Years)			Description
	<=5	<=10	All	
			X	For comparison of systems, the life cycle shall be waived to 15 to 20 years for all lease applications.
	X			Redundancy
				Listed below are the exceptions to the NIH <i>DRM</i> only and use of the exception is optional. Regardless of the exceptions and any other requirements, all work must conform to the NEC.
			X	Economic analysis for selection of building voltage
			X	Analysis for step down transformers as large central units or as smaller distributed units
			X	Requirement for power system study with SKM software. (A study is still required but use of SKM software is not.)
			X	Submission for O&M manuals to Government if Government not performing the maintenance.
			X	Paragraph specific to the NIH Bethesda campus is not applicable. NIH will not provide determination of service provider.
			X	Paragraph specific to the NIH Bethesda campus
			X	Paragraph specific to the NIH Bethesda campus
			X	Paragraph specific to the NIH Bethesda campus
			X	Paragraph specific to the NIH Bethesda campus
			X	Paragraph specific to the NIH Bethesda campus
			X	Paragraph specific to the NIH Bethesda campus
			X	While load figures can be used as a guide and for confirmation of calculated service sizing applicability, actual National Electrical Code [NEC] (NFPA 70) requirements for service sizing should be used since the Government is not the authority having jurisdiction. Some spare capacity is recommended to allow for anticipated changes in program function over the course of the lease term, typical of biomedical facility construction.
			X	Paragraph specific to the NIH Bethesda campus is not applicable.
			X	Switchgear is not required to be metal enclosed gear with draw out circuit breakers.
			X	Bussing is not required to be copper, but is recommended to be copper.
			X	Switchgear arrangement is not required to follow NIH network system arrangement.
			X	Dual ground bus arrangement is not required for a non-spot network system.
			X	Full metering is not required, nor is any SCADA metering, monitoring or control.
			X	Switchboard construction would be allowed.
			X	Switchgear lineups are not required rail assembly or lifting hoist.
			X	Any specialized tools for installation, maintenance, calibration, or testing are not required to be provided to NIH, but should be provided to building owner.
			X	Paragraph specific to the NIH Bethesda campus

Check Box	Lease Duration (Years)			Description
	<=5	<=10	All	
			X	Work space clearances beyond NEC requirements
			X	Ventilation, temperature and humidity requirements for electrical rooms
			X	Paragraph specific to the NIH Bethesda campus
			X	Testing is not an NIH requirement if the distribution system is not NIH owned.
			X	Wire color coding does not necessarily have to follow the NIH coding indicated, but must be consistent throughout a facility, and comply with NEC where applicable.
			X	Conduit size beyond NEC required minimum sizing
			X	Electrical metallic tubing fittings are not required to be compression type.
			X	Conduit types not specific to biomedical facilities shall conform to NEC but not necessarily to <i>DRM</i> .
			X	Manhole and handhole spacing and wiring pulling requirements
			X	Copper requirement for busway
			X	Cable tray requirement. (The only requirement for telecommunication cabling is some type of wiring management system must be provided.)
			X	Circuit breakers are not required to have a dc rating for the frame series (i.e., E-frame).
			X	Not every panelboard is required to have a main circuit breaker.
			X	Copper bussing requirement
			X	Full piano hinged trim requirement for panelboards 400 amperes and above
			X	Closet sizing shall be such to meet NEC required minimum clearances and work space requirements.
			X	Panelboard locations do not have to meet NIH maximum distances for devices, so long as voltage drop following NEC requirements is accommodated.
			X	With the exceptions of emergency power and isolated ground receptacles, device color coding is not required to follow NIH standards.
			X	Information specifically related to NIH Building 10
			X	Paragraph specific to the NIH Bethesda campus
			X	Requirements indicated for specialty twist lock fire department receptacles is by a Montgomery County (Maryland) Executive Order, and is only required for facilities in that county.
			X	Paragraph specific to the NIH Bethesda campus
			X	Paragraph specific to the NIH Bethesda campus
			X	Motor voltages shall comply with available building voltages.
			X	Motor starter accessories are not required to comply with those indicated.
			X	Motor control centers are not required in lieu of grouping of individual motor starters.
			X	Contact with NIH senior electrical engineer is not necessary.
			X	Site lighting and exterior lighting types
			X	Lighting pollution and cut off shielding
			X	Site lighting pole tag
			X	Site lighting spacing as shown is waived but design shall as a minimum follow IESNA recommendations.
			X	Street lighting circuits, controls and wiring
			X	Parking garage lighting and control
			X	Connections to lighting fixtures
			X	Site lighting circuit voltages and information from NIH project officer and NIH electric shop
			X	Exterior lighting control



Check Box	Lease Duration (Years)			Description
	<=5	<=10	All	
			X	Light pole maximum height
			X	While load figures can be used as a guide and for confirmation of calculated service sizing applicability, actual National Electrical Code (NEC) (NFPA 70) requirements for service sizing should be used since the Government is not the authority having jurisdiction. Some spare capacity is recommended to allow for anticipated changes in program function over the course of the lease term, typical of biomedical vivarium facility construction.
			X	Racking system requirement
			X	While load figures can be used as a guide and for confirmation of calculated service sizing applicability, actual National Electrical Code (NEC) (NFPA 70) requirements for service sizing should be used since the Government is not the authority having jurisdiction. Some spare capacity is recommended to allow for anticipated changes in program function over the course of the lease term, typical of biomedical laboratory facility construction.
			X	Surface metal raceway requirement
			X	Surface metal raceway circuiting with local overcurrent protective devices
			X	60A., 3 phase, 4 wire circuit minimum per laboratory
			X	Number of circuits for computers and receptacles
			X	20A., 120V. circuit in junction box on ceiling of each lab module
			X	Any emergency powered lighting fixtures required in BSL-2 laboratories is at program discretion, unless required by Code for egress lighting. At least one lighting fixture per BSL-3 and BSL-4 laboratories per module is required on generator emergency power – additionally, these same fixtures are also required to be provided with a self testing emergency battery ballast to carry through the generator start time without having these areas in complete darkness.

### NIH *DRM* Leased Facility Waiver Checklist – Environmental

Instructions for use: This checklist includes only those items that are waived. Every part of the NIH *DRM* not listed on the table applies to all NIH projects. Where the table shows an “x” in the “all” column, the referenced paragraph is waived for any lease project regardless of the lease duration as described in the “description column”. For example, in the architectural sheet, for *DRM* reference, lease facilities in existing buildings are not required to conform to the thermal performance of windows, exterior doors, glazed panels and skylights. Because the description states existing facilities, new facilities would need to conform unless a variance is approved. Existing facilities would not need a variance when in non-conformance. In some cases the description summarizes or copies the part that is waived. For lines in the checklist where the “x” is in the “<=5” column, then the application is similar to that described above except that instead of waiving the requirement for all lease projects, these are only waived as described for leases that are 5 years or less. Likewise the “<=10” column are for waivers that only apply to leases with a 10 or less year duration.

Check Box	Lease Duration (Years)			Description
	<=5	<=10	All	
			X	Leased facilities shall provide the necessary containers and collection services to meet recycling requirements of the Montgomery County Business Recycling Regulations.

# Appendix K

## DRM Variance Form

**DIVISION OF TECHNICAL RESOURCES (DTR)  
NIH DESIGN REQUIREMENTS PROJECT SPECIFIC**

**REQUEST FOR VARIANCE**

Drawing Reference: _____  Detail Number: _____  Spec. Section Reference: _____  Paragraph # in Guidelines: _____  Campus <input type="checkbox"/> On <input type="checkbox"/> Off	To: <b>Variance Review</b> (301) 451-4954 Email: <a href="mailto:ORFDTRIntakeCenter@mail.nih.gov">ORFDTRIntakeCenter@mail.nih.gov</a> Phone  From: _____ Project Officer _____ Email _____  A/E Name _____ Phone _____ Date _____  Work Request Number _____ Proposed Variance Subject _____  <input type="checkbox"/> Yes <input type="checkbox"/> No Type _____ New Construction _____ e.g. lab, animal, office, BSL?
---	--

**(Variances should be requested during pre-design or early in the design phase.)**

Project Title \_\_\_\_\_

Building Number \_\_\_\_\_ Estimated Construction Cost \_\_\_\_\_

Location \_\_\_\_\_ Project Percent Completed \_\_\_\_\_ %

Describe Variance. State specifically how it deviates from the guidelines, how it improves the existing condition and the advantage to implementing. Provide hard copy supporting documents as necessary to variance coordinator:

Provide recommendation of discipline or disciplines to review variance; i.e. mechanical, electrical, architect, civil, structural, fire protection or other:

**PLEASE DO NOT FILL IN BELOW THIS LINE.**

DTR Routing: \_\_\_\_\_

DTR Response: \_\_\_\_\_

APPROVED

NOT APPROVED

REVISE & RESUBMIT

# Appendix L

## Sealant Table

**Sealant Types:****JS-1** Architectural Urethane Sealant ASTM C920**JS-2** 100% Silicone ASTM C920

- Use mildew resistant silicone sealant when sealing toilets, sink faucets and other plumbing fixtures, and in areas subject to standing water and dampness.
- Use aluminum finish silicone sealant when sealing stainless steel in cage washers, tunnel washers, rack washers and other stainless steel equipment, fixtures and assemblies.

**JS-3** Siliconized Acrylic Latex ASTM C834 (Note: Latex plus silicone is not an acceptable product)**JS-4** Non-Halogenated Latex-Based Elastomeric Sealant ASTM C920**Key:****BSL** Biological Safety Level**ABSL** Animal Biological Safety Level**JS** Joint Sealant**N/S** No Sealant**N/A** Not applicable

\* Refer to Comments

\*\* Confirm with NIH Pest Management Representative

**General Sealant Notes:**

1. Submittals for approval by NIH Project Officer (PO) and NIH Pest Management Representative:
  - a. A list of sealants for project, with product data
  - b. Sealant Installation Execution Plan: The Execution Plan shall indicate the responsible party for installing all sealants, including their experience and qualifications.
2. For ABSL-2, ABSL-3 and BSL-3 projects, all joints, gaps, seams, penetrations and voids in the laboratory perimeter enclosure (including floor, ceiling, walls, doors, windows) shall be completely sealed, forming a continuous monolithic and impermeable infiltration barrier. All fixtures, furniture and devices (including fixed equipment, casework, shelving systems, mechanical and electrical devices) shall be completely sealed, including, but not limited to, all conditions listed in the Sealant Table. The PO and NIH Pest Management Representative shall be notified if further clarification is necessary.
3. Penetrations in rated assemblies shall be appropriately UL listed and approved by the DFM. Finish sealants, listed in the Sealant Table, shall be in addition to, and not a substitute for, rated sealants.
4. Confirm compatibility between sealants, and between sealants and the materials to which they will be applied.
5. A sealant mock-up shall be constructed for approval of the PO and Pest Management Representative. The mock-up shall include all typical conditions and materials, and shall remain in place as a basis of comparison and approval of the final installation.
6. All BSL-3 and ABSL-3 sealants shall be color White.
7. Non-Lab column lists requirements for spaces that are within the laboratory facility but outside of the laboratory room and zone.
8. Sealant of plates, escutcheons and similar items can be bedded or bead at perimeter.
9. Sealant must be full coverage, without gaps or voids. Sealant must be applied in an even and professional manner, without drips or excessive material. Previously sealed items shall be cleaned of old sealant and properly prepared for resealing. Sealant cannot adversely impact the operation of sprinklers or other devices. Sealant shall be installed following manufacturer's recommended methods and details.
10. Porous insulation shall not extend through BSL-3, ABSL-3 and ABSL-2 perimeter walls, but shall be sealed at walls.



Group	Description	Non-Lab Sealants	BSL-2 Sealants	BSL-3, ABSL-3 and ABSL-2 Sealants	Comments
Doors	Seal all penetrations in doors	N/S	N/S	JS-2	
	Seal all door hinge plates (not at pin) to include piano hinges	N/S	N/S	JS-2	
	Seal door frame and wall board interface	JS-3	JS-3	JS-1	
	Seal view panel frames (around glass whether or not gasketed)	N/S	N/S	JS-2	Interior and exterior sides
	Seal around lock sets	N/S	N/S	JS-2	Seal between escutcheon plates and door
	Seal around all sides of latch boxes installed within frames	N/S	N/S	JS-2	
	Seal door thresholds to the floor and around the threshold	JS-1	JS-1	JS-1	
	Seal door protection plates and tapered door guards to doors	N/S	N/S	JS-2	
	Seal gaps around door magnet latch at head of door and frame	N/S	N/S	JS-3	
Cabinetry/ Shelving	Seal openings in the base of tables where the support feet mount to the table	N/S	JS-3	JS-2	
	Seal openings in table legs where the support feet mount to the floor	N/S	JS-3	JS-2	
	Seal all cabinets where they contact dissimilar materials and where they contact one another	N/S	JS-1 or 3**	JS-1 or 3**	Cabinets need to be closed boxes. Seal all voids and joints in cabinet construction. Seal all removable panels.
	Seal all counter tops where they contact with dissimilar material	N/S	JS-1 or 3**	JS-1 or 3**	Depends on finish
	Seal around all shelf support brackets where they contact the shelves and are mounted to the walls	N/S	N/S	JS-3	This is for specialty shelving used in laboratories.
	Seal tops and bottoms of all wall mounted shelving brackets	N/S	JS-3	JS-3	A plug shall be sealed
	Seal all gaps and openings in racks	N/S	N/S	JS-2	For ABSL-3 equipment, typically stainless steel racks in aquatic rooms
	Seal covers between shelf standards	N/S	JS-1 or 3**	JS-1 or 3**	
	Seal peninsula shelving support at countertop and at ceiling	N/S	JS-1 or 2**	JS-1 or 2**	
Walls/ Floors/ Ceilings	Seal around all wall guards, bumpers, and rails	N/S	JS-3	JS-3	Brackets/fasteners shall be installed tight to wall.
	Seal all penetrations on the top and bottom of slab	N/S	JS-4	JS-4	To include but not limited to HVAC, plumbing, and electrical penetrations, and like penetrations through interstitial space.
	Seal around all corner guards	N/S	JS-3	JS-3	Brackets/fasteners shall be installed tight to wall.
	Seal around all door bumpers	N/S	N/S	JS-3	Brackets/fasteners shall be installed tight to wall.
	Seal top of trim strip and sheet flooring at wall	N/S	N/S	JS-3	
	Seal top of cove base	N/S	JS-1	JS-1	
	Seal bottom of cove base	N/S	JS-1	N/A	Integral base required in BSL-3, ABSL-3 and ABSL-2
	Seal all ceiling access panels (whether or not 100% gasketed)	N/S	N/S	JS-3	
	Seal the perimeter of all suspended acoustical or FRP ceiling frames at the wall juncture	N/S	JS-3	JS-3	
	Seal all interior window frames (including gasketed areas)	N/S	JS-2	JS-2	Sealant shall be sloped to promote cleaning. Seal all joints, including stops, juncture to glass and screw heads

Group	Description	Non-Lab Sealants	BSL-2 Sealants	BSL-3, ABSL-3 and ABSL-2 Sealants	Comments
(continued) Walls/ Floors/ Ceilings	Seal around wall and ceiling, surface-mounted cover plates and surface-mounted mounting plates	N/S	JS-1 or 3**	JS-1 or 3**	This applies to exposed mounted brackets. The use of sealant at these brackets is as follows: 1) If the bracket or wall mounted fixture is easily removable, then sealant is not required, 2) If the brackets are permanently affixed to wall, then joints shall be sealed. Each bracket shall be examined for requirement of sealant on a case by case basis.
	Seal all around floor surface-mounted mounting plates	N/S	JS-1	JS-1	This applies to exposed mounted brackets. The use of seal at these brackets is as follows: 1) If the bracket or floor mounted fixture is easily removable, then sealant is not required, 2) If the brackets are permanently affixed to floor, then joints shall be sealed. Each bracket shall be examined for requirement of seal on a case by case basis.
	Seal all around floor surface-mounted cover plates	N/S	JS-1	JS-1	
	Seal and cap the tops of all CMU walls	N/A	N/A	N/S	Animal Research Facilities' CMU walls shall be capped with cap block. Seal penetrations of cap block with JS-3
	Seal control joints in walls	N/S	JS-1	JS-1	
	Seal control joints in ceilings	N/S	JS-1	JS-1	
	Seal control joints in floors	JS-1	JS-1	JS-1	Not visible to room – beneath floor. Use sealants recommended by flooring manufacturer under resinous floors
	Seal joints between walls of dissimilar materials	JS-3**	JS-3**	JS-3**	
	Seal space in wall penetrations, including inside sleeves, collars, and surrounding construction	JS-4	JS-4	JS-4	Where stuff mineral wool is applied, use fire stop and spray over with JS-4.
HVAC	Seal all duct work that penetrates the wall envelope	N/S	JS-3	JS-3	
	Seal all diffusers/grill joints in hard ceilings	N/S	JS-3	JS-3	
Plumbing	Hot water line insulation shall be wrapped in aluminum and the seams and ends of the insulation sealed	N/S	JS-2	JS-2	This applies for steam lines (e.g., autoclaves).
	Seal at vacuum pass through	N/S	JS-3	JS-3	
	Seal all cracks in foam rubber water line insulation	N/S	JS-3	JS-3	
	All flat escutcheon plates and support standoff brackets for animal water systems shall be sealed all around	N/S	JS-3	JS-3	
	Seal plumbing to surface	N/S	JS-3	JS-3	
	Seal all plumbing escutcheon and cover plates at the wall and pipe junctions	N/S	JS-3	JS-3	
	Seal around sprinkler collars	N/S	JS-3	JS-3	Seal inside and outside of collar. Confirm that sealant does not interfere with sprinkler operation.
	Seal all piping that penetrates the wall envelope	N/S	JS-3	JS-3	
Electrical	Conduit and raceway shall be sealed tight to wall or ceiling surfaces	N/S	JS-3	JS-3	Sealant is required on both sides of surface mounted conduit and raceway.

Group	Description	Non-Lab Sealants	BSL-2 Sealants	BSL-3, ABSL-3 and ABSL-2 Sealants	Comments
Electrical (continued)	Seal the perimeter of all electrical panels	N/S	*N/S	JS-3	Panelboards in BSL-2 spaces do not require sealing – if done, recommend with gasket only. Locating panelboards within ABSL areas shall be avoided and shall never be placed in actual BSL-3 space. If required within ABSL space, gasketing and sealing is required. Sealing of cover plates in BSL-2 is not required.
	Seal joints between ceiling and light fixtures in hard ceilings	N/S	* N/S	JS-3	Surface and recessed mounted lighting fixtures shall have sealant applied between fixture enclosure and ceiling surface. Recessed mounted fixtures shall have manufacturer's gasketing applied between fixture lens trim cover and adjacent ceiling surfaces.
	Seal perimeter of device boxes to adjacent drywall/CMU. Wire within conduit shall be sealed also.	N/S	* N/S	JS-2	Applicable for ALL power, communications, signal and control applications within ABSL-2 facilities: All device boxes shall be cast type with external hub. Where device boxes and conduits are recessed mounted, the box to the adjacent wall, ceiling or floor surface shall be sealed. All wiring shall be provided in either threaded rigid galvanized steel (RGS), intermediate metal conduit (IMC), or electrical metallic tubing (EMT – only when recessed and with compression fittings). Gasketed device cover plates shall be used, with an additional continuous bead of silicone sealant between the device box cover plate and the adjacent wall, ceiling or floor surface. Where device boxes and conduits are surface mounted, and where the device box meets the wall, ceiling, or floor surface, a continuous bead of silicone sealant shall be provided. Non-recessed conduits are then required to be threaded RGS on minimum 19 mm (3/4 in) standoffs, or if also surface mounted, both sides of the conduit shall be sealed to adjacent surfaces with silicone caulk. Once wiring is installed, the wiring shall be surrounded by a one inch barrier of silicone caulking around the conductors within the device box hub. This prevents vermin harborage in and transmission through the electrical distribution systems.

Group	Description	Non-Lab Sealants	BSL-2 Sealants	BSL-3, ABSL-3 and ABSL-2 Sealants	Comments
Electrical (continued)	Seal perimeter of device boxes to adjacent drywall/CMU. Wire within conduit shall be sealed also.	N/S	*N/S	JS-2	Applicable for ALL power, communications, signal and control applications within ABSL-3 and BSL-3 laboratory facilities: All device boxes shall be cast type with external hub. Where device boxes and conduits are recessed mounted, the box to the adjacent wall, ceiling or floor surface shall be sealed. All wiring shall be provided in either threaded rigid galvanized steel (RGS) or intermediate metal conduit (IMC – only when recessed). Gasketed device cover plates shall be used, with an additional continuous bead of silicone caulk between the device box cover plate and the adjacent wall, ceiling or floor surface. Where device boxes and conduits are surface mounted, and where the device box meets the wall, ceiling, or floor surface, a continuous bead of silicone sealant shall be provided. Non-recessed conduits are then required to be threaded RGS on minimum ¼” (19 mm) standoffs, or if also surface mounted, both sides of the conduit shall be sealed to adjacent surfaces with silicone sealant. Once wiring is installed, the wiring shall be surrounded by a one inch barrier of silicone caulking around the conductors within the device box hub. This provides for a gas-tight electrical installation allowing decontamination of the BL3 space, and prevents vermin harborage in the BL3 space, and prevents vermin harborage in and transmission through the electrical distribution systems.
Equipment	Seal all fixed equipment that is within 38 mm or less from a ceiling	N/S	JS-1	JS-1	
	All sinks shall be sealed if they contact other surfaces, including mounting and support brackets	N/S	JS-1	JS-1	
	Large gaps, behind the back splash shall be filled in with foam cord and sealed in place.	N/S	JS-3	JS-3	
	Seal all gaps and openings in secured/fixed equipment	N/S	N/S	JS-3	May hinder function of equipment – Review on a case-by-case basis.
	Seal gaps that exist between stainless steel sheet metal in all cage washers	N/S	JS-2	JS-2	
	Seal gaps that exist between stainless steel sheet metal in all tunnel washers	N/S	JS-2	JS-2	
	Seal gaps that exist between stainless steel sheet metal in all rack wash equipment	N/S	JS-2	JS-2	
	Seal around frames and holes inside of fire extinguisher boxes	N/S	JS-2	JS-2	Some doors have hollow channel in access doors. Seal access door frame channels and glass cover where no clips are present.
	Seal around the metal rod hangers used to hold the exhaust hoods where they penetrate the drop ceiling	N/S	JS-1 or 2**	JS-1 or 2**	
	Seal wall mounted heating/air conditioner unit casework and utility penetrations	N/S	JS-3	JS-3	
Fixtures	Seal floor mounted equipment supports, legs and standoff supports	N/S	JS-1	JS-1	
	Seal stainless steel equipment at all joints and gaps	N/S	JS-2	JS-2	
	Seal toilet mounted to surface	JS-2	JS-2	JS-2	
	Seal sink faucet mounted to surface	JS-2	JS-2	JS-2	
	Seal wall hung equipment at surface attachment	N/S	JS-2	JS-2	

# Appendix M

## Interior Signage Manual

## A. Purpose

The purpose of signage is to convey information and facilitate wayfinding by providing clear, uniform, and readily understandable messages. Signage aids in navigation and provides directions to destinations within a facility and routes for emergency egress. Signage is beneficial for all facility users, including long-time occupants and first-time visitors.

The purpose of this manual is to establish comprehensive, flexible, and uniform signage in all NIH facilities. It will also ensure visual consistency and adherence to government and national signage standards. Guidance on additional signage can be found in specialty chapters throughout the DRM.

## B. Applicability

This manual shall apply to all interior signage for all NIH-occupied facilities, whether owned or leased.

## C. Codes, Standards, and Guidelines

All signage shall comply with the latest published editions of applicable building and life safety codes and standards, including:

- Accessibility and the International Code Council (ICC)
- Architectural Barriers Act Accessibility Standard (ABAAS)
- Biosafety in Microbiological and Biomedical Laboratories (BMBL)
- International Building Code (IBC)
- National Fire Protection Agency (NFPA)
- NIH Design Requirements Manual (DRM)
- NIH Identity Guidelines
- NIH Room Numbering Guidelines
- NIH Policy Manual 1186
- Nuclear Regulatory Commission (NRC)
- Occupational Health and Safety Administration (OSHA)
- Office of Management Guidance for New NIH Logo

This manual shall be used in conjunction with project- and building-specific guidelines and requirements. Signage design shall be coordinated with applicable

building integrity guidelines, campus Master Plans, and existing exterior signage systems. All signage incorporating room numbering shall comply with the NIH Room Numbering Guidelines, and shall coordinate with existing room numbering systems.

## D. Room Numbering Guidelines

Reference the NIH Room Numbering Guidelines for room number selection guidance. The Office of Research Facilities, Division of Facilities Stewardship, Portfolio Assessment and Reporting Branch (ORF/DFS/PARB) determines the room numbering system for the identification of all spaces. This room numbering system shall be incorporated into facility design under DFS/PARB guidance beginning in the design development phase. The system will subsequently be reviewed by DFS/PARB at the 35%, 65%, and 100% submission points to ensure that all components are coordinated with the building's final room numbers.

## E. Wayfinding

The major components used in the wayfinding program are maps and written directions, verbal communication from hospitality staff, visual cues such as prominent art displays and landmarks, and standard, consistent signs and messaging.

### 1. Wayfinding Strategy

Effective wayfinding is important to the operation of any facility and enables the safe and efficient movement of people and materials. The development of an effective wayfinding strategy is dependent on several factors that are facility-specific, including facility function, size, complexity, floor plan, egress routes, and travel paths. Wayfinding goals may include:

- Directing a new visitor from the entrance of a facility to their destination(s) quickly and efficiently
- Providing a complex facility with a sense of identity, order, and organization
- Eliminating busy cross-traffic paths and other congested and confusing conditions
- Separating the public from private, secure, hazardous, or other sensitive areas or functions



- Identifying egress routes
- Locating and identifying key facility features and destinations

## 2. Travel Path

One important factor in wayfinding is the analysis of employee and visitor travel paths. Travel paths shall be identified for people (employees, visitors, and other building users), material delivery and distribution, waste, and other facility traffic. Travel paths shall also be identified for parking garages, utility tunnels, loading docks, and other required secondary functions. Desired travel paths can be based on shortest distance, fewest turns, separation of functions, and other factors specific to the use of the building. Travel paths may be dispersed to minimize congestion, or may utilize lobbies, ‘main street’ corridors, and other active areas to enliven the facility.

Signage is required along travel paths at intersecting corridors and other locations where decisions must be made. Directional signage placed along the travel path is a helpful tool.

Travel paths may intentionally include interesting and noteworthy building features that are memorable and serve as landmarks and reference points.

## 3. Landmarks and Artwork

Landmarks and artwork placed at decision-making intersections provide helpful clues to those who are more visually focused. Outdoor views to atrium courtyards can help mark central pathways for wayfinding and are clearly identified on maps.

## 4. Maps

For cognitively focused wayfinders, maps and signs work well. Maps are prominently displayed in elevator lobbies throughout the building and are also used by hospitality staff when giving verbal and written directions.

## 5. Navigation Tools

In addition to signage, visual design elements are effective for differentiating spaces and providing a sense of orientation and identification

in a complex facility. Wall and trim color, floor material, furniture, and other elements can be effective methods of identifying floors, departments or suites.

## 6. NIH Logo

Signage logo selection is another very effective method of identifying building areas. An example of this is the selection of a particular design logo for the main office identification sign. The same office logo that is used on the office identification sign is repeated on every interior space on a smaller scale. All NIH logos shall comply with NIH Policy Manual 1186 – Use of NIH Names and Logos. All Office of Management (OM) offices shall follow the Office of Management Guidance for New NIH Logos. All Institute and Centers (IC) shall follow the NIH Identity Guidelines.

## F. Signage System

### 1. Signage Plan

A signage plan shall be developed for every new facility and large addition or renovation project. The signage plan shall include:

- A narrative and graphic description of the overall wayfinding strategy for the facility
- Key travel paths
- The location of every sign and directory in the facility
- The type of sign at each location
- Mounting height and details
- Graphics, text, and other pertinent information

The signage system should be consistent and flexible. It shall be designed to be expandable and to accommodate changes and updates.

### 2. Construction Documents

The project Scope of Work (SOW) and the Project Officer (PO) shall determine whether signage is a task within the base construction project or a separate contract. Regardless of contracting method, the signage construction documents shall provide detailed drawings of

every sign type, a plan showing every sign location, drawings of typical mounting heights and details, and a schedule listing the text, font, size, type, and all other pertinent information for each sign. Signage specifications shall be developed and approved during early design phases and shall be further developed and detailed as the design progresses.

The signage system should be capable of easily accommodating future spatial and personnel changes. The selected signage style shall compliment the interior space and enhance the department's interior design scheme.

Unframed paper signs shall only be considered for temporary and emergency use situations.

### 3. Signage Material

Materials shall be selected based on aesthetics, durability, and readability, and may include wood, vinyl, acrylic, stainless steel, and a variety of other metals. Signage may be complimented by illumination features as well as material and color combinations.

### 4. LED signs

Light emitting diode (LED) signage is a unique option for a signage system. LED signs are typically used for displaying messages and are used in lobbies and other prominent locations.

LED signage can incorporate graphics, text, maps, and interactive technology. They are flexible and programmable. Text and graphic information displays may be changed with a computer interface. LED signs can be used to provide weather information, announcements, notifications, and other useful and helpful information.

### 5. Text style and size

Text style and size are important considerations which can impact the legibility of signage. Consider clarity and consistency when selecting text style and size. The text must be in accordance with the ABAAS and Appendix H of the IBC.

### 6. Braille

All interior navigation and room identification signs shall have both visual and tactile text characters. Provide either one sign with visual and tactile characters, or two separate signs, one with visual and one with tactile characters.

### 7. Sustainability

Sustainable design principles are a requirement of all signage specifications, in accordance with the sustainability goals of the project. Sustainable design principles shall include:

- Recycled content and recyclability
- Regional manufacturing
- Low-emitting adhesives or no adhesives
- Energy efficiency

### 8. Installation

Signs shall be mounted in accordance with the signage manufacturer's instructions and the ABAAS. The mounting method shall minimize damage to walls and shall be durable.

## G. Building Directory

A building directory is required at the public entrance(s) of all facilities. The directory may be placed in conjunction with an orientation map, which conveys the general building layout and key building destinations. The directory shall be located so that it is highly visible without impeding persons passing through the entrance. Each floor should have a list of key offices, suites, and other destinations and their particular room locations.

## H. Room Signage

### 1. Sign Placement

Provide space identification signage for all normally occupied rooms. Signage shall indicate the room number and function of the room and/or room occupant(s).

Signage shall be located on the wall next to the latch side of the entrance door. The font size, height above the floor, and other aspects of the signage design and placement shall be in accordance with the ABAAS and Appendix H of the IBC.

Signage projects with potential to affect historic

properties (buildings eligible for listing in the National Register of Historic Places) are subject to review by the NIH Federal Preservation Officer and the Maryland Historical Trust. In these buildings, avoid harm to ornamental/decorative features. Mounting to plain, easily repairable wall surfaces is preferred

## 2. Signage Locations

In addition to occupied rooms, signage is required for the following areas:

- Break rooms and pantries
- Building operation, maintenance rooms, and closets
- Changing rooms and lactation rooms
- Conference rooms
- Elevators
- Floor identification
- Housekeeping rooms and closets
- Laboratories, vivariums and support rooms
- Loading docks (shipping and receiving)
- Open offices and cubicles
- Restrooms, shower rooms, locker rooms
- Stairways
- Storage rooms and mail rooms
- Other spaces identified by the PO or facility manager

Additional signage, as required by regulatory codes and regulations and the Authority Having Jurisdiction (AHJ), includes:

- Access, use, and activity regulations
- Chemical, biological, and radiological safety
- Egress routes
- Emergency exits
- Fire and emergency regulation
- Hazardous areas
- Regulatory signage

## 3. Other Required Signage

**Emergency Related Equipment** – Emergency information signage is required for

emergency-related facilities such as safety equipment and first aid facilities.

**Restroom Signage** – Provide navigation signage in intersecting corridors, main lobbies, and elevator lobbies to indicate directions to restrooms.

## 4. Confined Spaces

All spaces that are classified as confined spaces shall be identified by signage. If the workplace contains permit-required confined spaces, danger signs shall indicate the existence and location of the confined space, and the danger posed.. Signage shall clearly identify all relevant access restrictions.

Caution signage shall be located on the entrance door of each permitted confined space. The sign shall state “DANGER – PERMIT-REQUIRED CONFINED SPACE, DO NOT ENTER” or use other similar language to satisfy the requirement. The sign shall state that the space has been identified as a confined space and shall also indicate the special equipment and/or training required in order to enter the space.

## 5. Hazard and Biohazard Signs

Signage shall be provided for hazardous and biohazardous areas. Specific requirements shall be reviewed and approved by the regulatory authorities and the appropriate AHJ including the Division of Occupational Health and Safety (DOHS), Division of Radiation Safety, and the Office of Research Services.

See [Section 4.9.12 Signage](#) for signage requirements for BSL-3 and ABSL-3.

Hazardous areas that must be identified with signage include:

- All areas where PPE is mandated
- All areas with an identified hazard or hazardous conditions, or conditions that are likely to be life-threatening
- Animal facilities and specialty labs - signage cannot indicate that a radionuclide irradiator is present per 10 CFR 37.43(d) - contact DRS
- Biological containment areas

- Chemical storage
- Hazardous plant rooms
- High noise areas
- High voltage areas
- Incineration rooms
- Laser use areas
- Quarantine areas
- Radiation areas - contact DRS
- Restricted areas
- Roof access points
- Service tunnels

Typical hazards that require notification signage include:

- Agents in use
- Biological safety level
- Investigator's name, telephone number
- Required immunizations
- Required personal protective equipment (PPE)
- Required procedures for entering and exiting the laboratory

## I. Exit Signs

For this section, follow the latest NFPA Life Safety requirements.

### 1. Means of Egress Signage

Exit signs shall comply with applicable codes and the requirements of the appropriate AHJ. The signage shall comply with the International Symbol of Accessibility under the ABAAS, and the International Code Council (ICC) A117.1, and the NFPA 101 Life Safety Code.

Exit signs shall be internally illuminated. The word "EXIT" shall be in high contrast with its background and be clearly visible. Exit signs are to remain illuminated at all times.

### 2. Signage Placement

Place signage at exits and elevators serving a required accessible space. Place signage indicating the locations of accessible means of egress

and areas of refuge.

Provide a tactile sign stating EXIT adjacent to each door to an egress stairway, exit passageway, and exit discharge area.

When possible, avoid having multiple exit signs within the line-of-sight that lead to the same exit.

Locate new exist signs so that no point in the exit access is further than 100-ft line-of-sight.

### 3. Sign Illumination

The face of the exit sign shall have an intensity of no less than 5 foot-candles.

### 4. Self-Luminous Exit Signs

Self-luminous exit signs are not permitted. See [Section 9.4.2 Fire Department Access](#) for additional information.

## J. Building 10 Clinical Center Complex

The Clinical Center wayfinding program strives to ensure that patients, staff, and visitors feel comfortable with basic facility navigation from the minute they enter. The program is designed to promote healing because understanding the environment provides visitors with a sense of control and empowerment, which are key factors in reducing stress, anxiety and fear. A good signage program reduces stress and frustration while communicating a sense of professionalism.

### 1. Wayfinding Strategy

The Clinical Center uses a building block approach to wayfinding, recognizing that individuals receive and process information differently. Redundancy and overlap of multiple kinds of navigational tools help assist people with varying cognitive skills.

### 2. Personal Assistance

For some visitors, the only way to navigate the system is with personal assistance. Hospital staff and volunteers are encouraged and trained on the wayfinding approach and often escort the patient or visitor to their destination. Provide signage that indicates how to contact personnel when personal assistance is needed.

### 3. **NIH Identity Guidelines**

All Building 10 Clinical Center Complex signage for all Institutes and Centers shall be designed in accordance with the latest NIH Identity Guidelines and the NIH Medical Arts Branch. Coordinate new room numbers and names with clinical center staff to ensure that wayfinding apps are updated appropriately.

## Sample Signage Catalogue List

Symbol	Signature Type
S1	Building Orientation Map and Directory
S2	Navigation System Signage Secondary Lobby
S3	Navigation System Signage Public Corridors
S4	Navigation System Signage Public Spaces
S5	Navigation System Signage Office Suites
S6	Navigation System Signage Ceiling Mounted
S7	Navigation System Signage Wall Mounted
S8	Navigation System Signage Corner Mounted
S9	Floor Identification
S10	Corridor Directional
S11	Department Name
S12	Room and Suite Identification
S12	Cubicle Identification Signage
S13	Public Space Signage-Sign Type
S14	Restrooms
S15	Permanent Corridors
S16	Stairways
S17	Public Elevators
S18	Housekeeping
S20	Building Operation and Maintenance
S21	Hazardous Area
S22	Chemical Biological Safety
S23	Vivarium
S24	Fire Protection
S25	Emergency Exits
S26	Egress Routes
S27	Temporary Construction Signs
S28	Regulatory Signage
S29	Fire and Emergency Regulation
S30	Access, Use, and Activity Regulations
S31	Safety and Hazard Warnings



## Examples of Typical Signage

Name	Function
Decision Points	Navigation System Signage
Building Directory Non-Illuminated Changeable Strip	Building Directory which indicates the offices on one floor of the building
Building Directory Non-Illuminated Changeable Strip	Building Directory which indicates the offices within the building
Building Directory Rear Illuminated	Building Directory which indicates the offices within the building
Suite ID	Office suite personnel listing which indicates the employees within an office suite
Suite ID	Identify the office suite name which is placed at the main entrance of the office suite
Cubicle	List Name of function or person in a cubicle
Stair Location Contract Document Drawings	Identify the stair location, indicating the level of the stair, consisting of bilingual text and Braille
Women Restroom Contract Document Drawings	Identifies the placement of the restroom signage symbol, the room number as well as Braille
Danger Confined Spaces	Confined Spaces Special Equipment Required prior to entry
Danger Asbestos	Danger asbestos hazard warning that indicate the type of persons allowed in the space as well as the PPE required
Danger Confined Spaces	Confined Spaces identification which restricts access
Biohazard	Biohazard warning which identifies the type of hazard
Radiation	Radiation warning which indicates the present of radiation

Name	Function
Stair	Stair identification sign which shall be placed to identify the direction and location of the stair
Elevator	Elevation identification sign which shall be placed to identify the direction and location of the elevators
Toilets	Restroom identification signs which shall be placed to identify the location of the male and female restrooms
Directional	Directional signage placed along the travel path
Restricted activity	Signage that prohibits smoking

# Appendix N

## High Purity and Animal Drinking Water System Sanitization, Lab Testing, and Acceptance

This section outlines a method to assure that water quality can be verified to meet the requirements of the program. Other methods may be appropriate as determined by a risk assessment, performed by responsible program staff working with professionals experienced with design, installation, and operation and testing of such systems and facility personnel responsible to operate and maintain them.

Prior to use, each high purity water and animal drinking water system shall be thoroughly flushed, commissioned, and sanitized/disinfected with approved materials compatible with the system construction. Delivered water quality shall be comprehensively tested by qualified labs. The A/E shall specify the initial water quality tests to occur as part of the facility commissioning or system acceptance phases. Water quality results shall be reviewed, forwarded to the PO, and be determined acceptable prior to use.

**A. System Responsibility:** The point of acceptance of systems (program responsibility) shall be discussed with the PO, detailed in specifications, and coordinated to ensure that effective control of the system is maintained at all times by a responsible party; but shall not occur prior to complete verification, testing, sanitization, commissioning, submittal and subsequent acceptance of compliant test data by ORF and the program management.

**B. Visual Inspection and Adjustment:** The inspection and commissioning process shall confirm required back-flow control provisions have been met and that there are no cross-connections between systems. Correct system arrangement shall be verified, including confirmation of conformance with requirements as outlined in the *DRM*. All treatment components, system controls and devices shall be adjusted and instrumentation verified, including monitor settings, readouts, alarm functions, and integrated systems tests (including response to power failures). Items requiring field calibration shall be calibrated to NIST traceable standards. Offline testing shall not be relied upon exclusively for instrument calibration. Comply with individual instrument manufacturer requirements to maintain traceability of calibrations to reference standards.

**C. Animal Drinking Water Chemical Injection:** Adjustment, verification, and monitoring for correct set points and operation of proportioners/injection systems, flow meters, and other critical controls is required and

shall be validated through on-site tests, including monitoring of both near (immediately after proportioner/injector) and remote (end of system) points to ensure minimum and maximum disinfectant levels are within required criteria to be effective, not pose injury, or discourage drinking water consumption. Where ORP monitors, chemical sensors, dosage meters, and chlorine dioxide analyzers are used, set points shall be verified through on-site, post-installation confirmation. An EPA or ASTM method shall be utilized to validate initial residual disinfectant additive injection calibrations. A portable-type DPD photometer shall be used for chlorine. pH monitors shall be maintained calibrated in accordance with a NIST-traceable thermometer. The use of calibrated photometers (vs. handheld comparators) shall be used for initial set-up to ensure accuracy, except where other EPA/ASTM validated methods are utilized.

**D. Systems Flushing:** Individual equipment, piping lines, and all outlets shall be thoroughly flushed prior to final occupancy, use, sanitization, or connection of lab equipment to remove and prevent reintroduction of particles and stabilize water quality. Proper startup of individual components, including flushing of particle fines, conditioning and backwashing of media beds, soak period for carbon beds etc. shall be performed. All treatment beds (including carbon and softeners) shall be properly wetted, rinsed clear through the dump valve to clear particle fines, shedding, and other contamination prior to connection to the distribution system. Media beds shall be properly conditioned by thoroughly flushing to drain off multiple bed volumes per manufacturer's startup recommendations at sufficient flow rate to provide appropriate media distribution. Wetting and flushing procedures shall occur prior to distribution system sanitization. Upon the completion of flushing and testing, required post-treatment filter elements shall be installed and each system shall be sanitized and then maintained in operational status.

**E. Microbial Protection Required:** Once systems are wetted, sufficient microbial control shall be maintained without lapse. If disinfectant residual is not constantly maintained (e.g., high purity water); systems shall be drained, blown dry with filtered, clean nitrogen or argon, and maintained in dry state until properly sanitized and systems are fully operational; or appropriately timed to avoid such conditions.

Conventional animal drinking water systems (e.g., systems that will operate with residual disinfectant) may be maintained with potable, chlorinated water, provided the water is completely flushed and turned over on a regular basis, not exceeding one complete flushing and fresh water exchange of all piping and components every 24 hours. New high purity water and animal drinking water systems shall not be accepted with presence of established or deep-rooted biofilms, regardless of achievement of a subsequent successful water test.

*Rationale: Sloughing of biofilms can result in on-going microbial problems, particle issues, and general poor water quality once allowed to establish.*

**F. Sanitization and Disinfection:** Significant risks of pathogenic outbreaks and reduction of water quality can occur with partial removal of established biofilms. Prior to any sanitization of existing systems, consultation with the program to determine and mitigate risks (especially for ADW systems) is required.

The chemical sanitization process (or disinfection process in the case of ADW systems) can pose significant hazards if not safely planned. Fumes associated with chemical spills (or even normal process odors) can result in sudden risk to ARF and lab operations. Chemical usage shall be undertaken only by experienced, responsible personnel, working in teams of not less than two qualified persons, with an appropriate safety plan; and after discussions with responsible facility program personnel, including discussion of most significant hazards and the steps required to safely mitigate risks. In occupied facilities, chemical sanitization procedures shall be specified to occur only after notification and approval of timing by the PO, such that appropriate facility representatives are made aware of safety issues and risks. At no time during the sanitization process, from the time chemical is placed in the system until the time it is fully flushed from all outlets, may the system be left unattended by chemical handling personnel.

In the case of occupied facilities, outlets shall be labeled or otherwise protected to prevent use until safe use conditions are restored. Chemicals shall be utilized at required concentrations throughout the system, but for a minimal time required to achieve effective results, and shall then be immediately flushed from the system within

the same day upon achieving required contact duration. The sanitization and rinse process shall be sufficient to ensure complete coverage of wetted system contact materials, including the entire inside of product water storage tanks, pockets where air may be trapped, any dead-legs, and cycling of distribution system valves through both sanitization and rinse process. Where sufficient spray balls are present, the spray ball may be used.

Confirmation of as-constructed materials compatibility shall occur prior to introducing chemicals. For high purity water systems, initial disinfection shall be with hydrogen peroxide/peracetic acid high purity water systems sanitant. Hydrogen peroxide/peracetic acid shall not be used on any portion of copper systems. NSF-60 chlorine dioxide or hydrogen peroxide/peracetic acid may be used with stainless steel ADW. NSF-60 chlorine disinfection may be used for ADW systems only, and provided they are not constructed of stainless steel. Regardless of materials of construction, disinfection/sanitization processes shall be specified to be carried out in conformance with piping and chemical manufacturer requirements to prevent damage.

*Rationale: Though chlorine at concentrations of ~50 ppm can technically be used with 316 stainless steel under appropriate conditions, duration, and frequency limitations (following recommendations of the Nickel Institute), the potential of misapplication and damage to systems resulting in subsequent corrosion and loss of material surface conditions resulting from improper workmanship does not justify the risk with other suitable, and potentially more effective materials available.*

**G. Disconnection of Equipment:** Racks/Cages and associated disconnect hoses shall not be connected during the system sanitization process. In the case of high purity water systems, polishers and other lab equipment typically must be disconnected (except with ozone, refer to [DRM Section 12.1 High Purity Water Systems](#)). Individual components (e.g., cage rack manifolds and water polishers) must typically be individually sanitized and rinsed to prevent damage to equipment or accidental use, however this should be evaluated for each application with the program. Racks and equipment shall not be reconnected prior to complete verification of safe water quality.

**H. Rinsing and Validation of Removal of Sanitant:**

Sufficient personnel shall be present to ensure the rinse process can occur in a continuous manner to protect distribution systems from damage associated with extended contact with chemicals. All use points of ADW systems shall be checked to confirm complete rinsing of sanitant, as well as representative points as applicable to the configuration and sanitization approach for each high purity water system. Flushing is required from each outlet of both HPW and ADW systems. Water analysis testing shall not be conducted until sanitant has been effectively flushed and system is in normal, stabilized, DRM compliant operating status.

**I. Water Sampling:** Samples shall be drawn and collected by representatives of the water testing laboratory, properly trained, independent personnel, or other NIH-authorized personnel independent of the construction contractor and system vendor. Industry standards (e.g., EPA Standard Methods and test lab protocols for high purity water or specific system water quality) shall be strictly followed for proper handling of samples, use of proper, uncontaminated test containers, sample technique, preservations, refrigeration, protection from freezing, proper shipment etc. and these requirements shall be strictly followed and conducted under controlled conditions to prevent sample contamination. Accurate chain of custody logs shall be maintained. Samples to demonstrate TOC and microbial status shall be taken the same day and analyzed by the laboratory no later than the day after sampling. Sampling for resistivity, ions, and metals shall be taken the same day as other sample types for the same system, and analyzed within 7 days of sampling. Draws from normal use points (lab faucets) and samples valves should follow test laboratory requirements for sampling applicable to the type of device. If alcohol is utilized, a sufficient rinse is required prior to microbial sampling. TOC samples must be taken prior to any alcohol wipe. At least 2 samples shall be taken per point for any analysis. A temperature indicator blank shall be provided by the test lab, properly maintained with the samples and included with each package for samples sensitive to temperature (e.g., TOC and microbial).

**J. Test Labs:** Lab analysis shall be conducted by a pre-approved accredited laboratory. For high purity water systems, the lab shall be accredited in accordance with ISO 17025 by a signatory to the ILAC mutual recognition agreement, for analysis of low level trace elements, ions, TOC, microbial contaminants, and other required

analysis, and shall be specifically experienced with ultrapure water testing and so recognized within the scope of their accreditation. For ADW systems, NELAP (National Environmental Lab Accreditation Program) accreditation is additionally acceptable and with the exception of special systems operating at ultra-pure water quality levels, need only be certified for environmental/drinking water testing.

***Rationale:** Only qualified and experienced ultrapure water test labs should conduct the high purity system side analysis as there can be significant issues that impact the validity of the results as compared to techniques that may be more traditionally utilized in lower grade waters. Not all labs may perform all tests. The A/E should therefore be diligent in specification of testing requirements to ensure required scope and competency of labs and sampling personnel is addressed.*

**K. Validation Procedures:** Procedures for validating each water system shall be specifically suited to the intended water quality requirements, utilizing appropriate scientifically validated analytical methods and instrumentation sensitivity. Where available for the required test parameter, tests shall follow appropriate industry standards (ASTM, ISO, etc.) Analysis of ADW may follow EPA Standard Methods (SM).

**L. Sampling Points:** Sampling and analysis shall be conducted from sufficient points to reliably represent the quality of water supply delivered from any point in the system.

**M. Renovations:** For renovations where there are no changes in the production system and no modification of treatment components, testing may be conducted at the first and last point of use that may be affected by the renovation as determined appropriate and acceptable to the NIH and as necessary to provide reasonable assurance of water quality. For high purity water in such cases, offline TOC, offline conductivity, and microbial plate count is adequate unless serving special systems (e.g., USP/WFI). For ADW systems, microbial testing will typically be required along with additional testing as appropriate to the specific project condition. A comparative sample set taken from at least two adjacent dispense points immediately adjacent to the renovation



area may be required if failing results are repeatedly received and the cause is expected to be due to deficiency of an existing system. Observed deficiencies shall be reported.

**N. High Purity Water System, Specific Requirements:**

At minimum, the following water sampling and analysis shall be conducted at the main supply sample port (post treatment, leaving the production system but prior to the first outlet), and at the main return sampling port (after the last outlet, but prior to the storage tank and prior to any treatment equipment):

1. Offline TOC, (Required)
2. Microbial, (Required)
3. Anions, Cations, Ammonia, and Trace Metals (Required)
4. Offline Conductivity, (Highly Recommended, but optional)
5. Carbon Dioxide/Alkalinity (Optional, or as required)
6. Particle Measurement (Optional to validate final filter performance, unless mandated by NIH). Offline, SEM.

At minimum, the following water sampling and analysis shall be conducted at the first and last outlet of each floor of each wing of the facility, throughout each pressure zone. Additional test points should be considered (and may be required) based on size and configuration of individual systems. The required minimum samples shall be taken from a lab sink purified water dispersal tap:

1. Offline TOC
2. Microbial
3. Offline Conductivity
4. In lieu of Offline Conductivity, it is acceptable to test and analyze anions/cations/metals and ammonia to demonstrate adequacy.

Additional follow-on testing (e.g., but not limited to anions/cations, trace metals, organics speciation liquid chromatography/organic carbon detection (LC-OCD), epifluorescence microscopy, etc.) shall be provided as determined necessary for troubleshooting and analysis. The use of follow-on testing on a weekly basis for at

least a three week period is recommended for large systems and is required for critical system applications.

Sample analysis shall be provided between major equipment in the production/treatment train (examples TOC, TDS, TSS, turbidity, anions/cations, trace metals, hardness, free chlorine, microbial plate count, etc.) as appropriate to the application or determined necessary to validate performance. An offline check of the sample point at the TOC monitor shall be made for TOC.

**O. Existing Deficiencies:** Where existing systems are deficient, additional testing may be required to detect unacceptable levels of gram-positive bacteria or fungi as part of remedial action, and shall be determined on a project-specific basis. Observed deficient conditions should be reported to the PO.

**P. Analytical Water Quality Validation:** Fitness for use testing (e.g., validation of water quality specific to research analysis) is not a requirement under system design and construction. Fitness for use testing for analytical purposes, similar to other reagents is program responsibility.

**Q. High Purity Water Required Analytical Tests, Additional Requirements:** Comply with the following. Where appropriately justified or recommended by the accredited UPW test lab and approved by NIH, additional or alternative validated methods of sufficient sensitivity for the application may be appropriate and shall be submitted for approval.

1. **TOC:** Low-level TOC testing should follow ASTM D6317. Only labs experienced in conducting low-level offline TOC for ultrapure water with accurate test methods and instrument sensitivity down to 5 ppb or better should be utilized.
2. **Resistivity/Anions/Cations/Trace Metals:** Resistivity that cannot be taken online with quality, accurate instrumentation, shall follow ASTM D1125 and ASTM D5391, with CO<sub>2</sub> removal by membrane contactor or filtered argon sparging and compared to a reference UPW blank; or similar validated method to effectively achieve CO<sub>2</sub> removal for an offline sample without compromising water quality. Online monitoring with NIST-traceable, calibrated instrumentation should be used wherever

possible. Where offline resistivity is utilized, the results of the comparative UPW blank must also be reported. Methods for offline resistivity as described in Clinical Lab Standards Institute (CLSI) C3-A4 may also be used. Alternatively, trace metals, ammonia, anions and monovalent and divalent cations by ion chromatography/inductively coupled plasma mass spectrometry may be performed and analyzed.

3. **Microbial:** ASTM methods (e.g., ASTM F1094) with at least 72 to 96 hours incubation and with listed media (agar) should be used at minimum. Microbial plate count should typically be spread plate technique, Test Method SM9215C with 5 day, 20°C–28°C (68°F–82°F) incubation temperature with additional multiple agars, including conventional plate count agar (PCA), R2A, and Tryptic Soy agar as well as any specific agars or techniques as recommend by the test lab microbiologist for the specific water quality, application, and site condition to provide a sufficient assurance of microbial quality. Epifluorescence microscopy (EPM) should be considered and may be conducted to distinguish viable and non-viable bacteria or achieve rapid microbial status, and where used and adequately quantified it is generally not necessary to conduct plate count tests with multiple agars. EPA SM 9216B, Clinical Labs Standard Institute (CLSI) C3-A4, and ASTM D4455 should be followed for EPM. The limits of microbial test methods and their application to high purity water systems should be understood when interpreting test results (discuss with test lab). Inclusion of at least one sample (main return) ASTM method plate count agar testing should be incorporated from a remote point to supplement use of the direct count method.
4. **Particles:** Where particle testing is included (such as to evaluate final filter performance) the use of scanning electron microscopy (SEM) should be considered. Online particle counting is not required. Filter integrity should be verified, and no filters with damaged packaging may be installed. Manufacturer limits for on-site validation (e.g., water intrusion testing) shall be provided for final filters.
5. Dissolved CO<sub>2</sub> may follow ASTM D513 or other suitable method. Absence of anions is typically sufficient.

***Rationale:** Plate counts often underestimate the quantity of viable microorganisms (due partially to the presence of biofilms), sensitivity to selection of a suitable agar; and do not account for microbial byproducts, inactive (damaged or non-replicating) microbes, and cellular material. Tests when applied to single samples or limited agars may not in themselves provide adequate representation of system microbial quality (variations can occur widely in the same system dependent upon location of samples and sloughing of biofilms), or reflect presence or absence of a specific microorganism that may be of concern; therefore multiple tests may be required.*

#### **R. Animal Drinking Water, Specific Requirements:**

Testing shall be conducted at multiple points within the distribution system, including at a first outlet or sampling port located immediately after all production system components; at a last/remote outlet or a sampling port on the main system return upstream of any filter, tank, or treatment system component (where returns exist); and not less than three representative use points (connection for racks or final outlets) throughout the distribution system as selected by the program management. Large systems or systems spanning multiple floors shall require additional sampling as determined appropriate to represent the entire system. Reference test of inlet water conditions (pretreatment) is recommended. Where central bottle fillers or similar site-filled water packaging is included, testing at each such bottle/water filler is required. At minimum, the following water sampling and analysis shall be conducted:

1. **All Sampled Outlets:** Comprehensive Microbial, (Required)
2. **New Systems or Major System Changes (e.g., chemical or treatment process modifications):** Initial systems testing shall confirm water quality in accordance with the maximum contaminant levels, as established in the current edition of the SDWA primary drinking water regulations. This testing shall be conducted at not less than (2) points of the dispense system,

in addition to just after the source production equipment. This testing is not required for systems operating as potable water systems that have no chemical treatment, added or removed disinfectant, or other changes that could plausibly effect water potability.

3. **Major Production Equipment:** Sampling and analysis at startup of major equipment in the production train is recommended (e.g., TDS, TSS, TOC, turbidity, anions/cations (or offline resistivity), hardness, free chlorine, etc.) as applicable and between components as required to validate performance (e.g., softeners, RO, or any special treatment).
4. **End of System Outlet or Main Return (where present):** Offline TOC is recommended for conventional systems, required for systems operating chemical-free.
5. pH shall be tested and adjusted prior to chlorination.
6. Disinfectant residuals shall be tested and monitored at multiple points in the system, including at least the storage tank, first outlet, midpoint room, and endpoint.
7. Additional tests as warranted by the treatment process or unique site conditions shall be conducted as appropriate to ensure water quality. National Secondary Drinking Water Regulation contaminants/specific contaminant candidate list item testing, endocrine disrupters etc. shall be addressed to the extent required by the program in consideration of site supply source conditions, treatment methods, and research needs.

***Rationale:** A number of contaminants that may impact research are not regulated under primary drinking water regulations (e.g., copper, silver, sodium, zinc, biochemical, microbials, toxins, etc.), but many are covered under secondary regulations or on candidate contaminant lists that are not presently regulated. Though many such contaminants can be addressed by well-designed carbon and RO arrangements, review on a program basis should occur. A variety of DBPs can also be of concern and therefore should be checked especially where TOC values are found to be excessively elevated and chlorination is utilized.*

**S. Trend Period:** Testing shall be conducted and passed prior to system use. Unless waived by the program management, a period of verification is required. It shall consist of multiple microbial tests (e.g., weekly) conducted over at least a three week period to confirm stability for at least three outlet points (each at a different location) within the distribution system. Subsequent testing at intervals (e.g., quarterly) should be undertaken by the use group upon take-over of the system.

**T. Animal Drinking Water, Test Method Additional Requirements:** Comply with the following:

1. **Microbial Testing:** Testing shall include analysis for acceptable qualitative microbial levels to provide a program-management acceptable microbial profile to assure safe and reliable water quality. Microbial testing for compliance with SDWA, including coliform and E. coli is required. Additional testing shall be provided for specific microbial concerns, including specific pathogenic indicators, viruses, protozoans, etc., unless determined unnecessary by the program management. Additional indicators, e.g., the presence of coliphages (bacteriophages) and cyanobacteria (or associated toxins e.g., but not limited to microcystins) and fungi should be considered.

Cultivation methods inclusive of heterotrophic plate count with low-nutrient media including R2A and standard plate count agar shall be used; as well as other applicable agars as recommended by the test lab or program microbiologist for target pathogens or completeness of the profile. Methods shall be selected in conformance with EPA Standard Methods or ASTM for the water quality and system configuration (e.g., typically inclusive of potato dextrose agar, MacConkey agar (24 hour), Tryptic Soy agar, Eosin Methylene Blue agar, and Pseudomonas Isolation agar, in addition to PCA and R2A; or other justified and program approved media). A heterotrophic plate count (HPC) spread plate (SM 9215 C) 5 day technique is generally required for the cultivation unless otherwise determined sufficient by the test lab and approved by program management. Testing for coliphages is recommended as this can serve as an indicator of potential viral contamination. Subject to approval of program

management, systems designed to provide sufficiently high microbial quality may utilize direct count methods (e.g., epifluorescence microscopy) for sensitive applications or where immediate results and quantification of viable and non-viable bacteria are required in lieu of plate counts (however this would not typically be suitable for conventional ADW other than new RO systems soon after sanitization), as results will likely be too numerous to count (TNTC); and may require supplementation of testing if unacceptable levels are detected or for trending to verify microbial stability and to verify absence of specific pathogens of concern.

2. **Primary/Secondary Contaminants/Drinking Water Profile:** Follow EPA Standard Methods, or ASTM as applicable.
3. **TOC Testing:** Follow EPA Standard Methods, or ASTM as appropriate to the target level/water quality and test sensitivity.
4. **Disinfection Byproducts:** Test per EPA Standard Methods for any case where non-compliant Disinfection Byproducts (DBPs) levels may occur (e.g., chemical treatment without RO), or any case where residual disinfectant levels are elevated to plausibly result in non-conformance of DBP's.
5. **Acceptance Values:** For each parameter, not less than required for potable water, as stated in this section and relevant portions of the *DRM*; but additionally compliant with any more restrictive program requirements.

***Rationale:** Requirements for some research models (especially those of non-conventional health status) may be more restrictive than potable water requirements as established for healthy humans. Therefore, with SDWA potable water as the minimum standard, more rigorous acceptance criteria may still be applicable either for program needs or to maintain system performance (e.g., in the case of TOC, microbial, or even ionic contaminants), and can be system-specific. Specific pathogens, e.g., *Pseudomonas aeruginosa* and various water-borne microorganisms may be of special concern in biomedical research applications.*

**U. Microbial Test Results:** Microbial acceptance values shall be considered in conjunction with the specific test method and through consultation with the test lab or program management. Minimum acceptable test results shall be program defined, but not less than as required for potable water per SDWA; with no detected coliform or *E. coli*. Neither coliphages nor cyanobacteria should be detected in the samples. Detection methods utilized for water testing can vary widely in accuracy and sensitivity, therefore results shall be analyzed based on specific conditions and test method and discussed with the accredited test laboratory and program management. The presence of any detected coliform or *E. coli*, HPC greater than 100 CFU/mL, or significant increases in HPC levels during trending is typically indicative of poor microbial control and system deficiencies, and should instigate further evaluations for pathogenic bacteria, viruses, identification of predominant organisms and the immediate implementation of any necessary mitigating actions.

Total heterotrophic plate count values should not be utilized exclusively as a pass/fail criteria, rather values must be tracked over time with multiple samples for trends to be monitored for microbial control efficacy. Microbial quality of water as detected through plate counts may not indicate the presence of debris from gram-negative microorganisms as many microorganisms may be present in the biofilms (and not free-floating) or not replicate during routine plate count methods; may not have been collected in the sample, or may not be responsive to the selected agar. Therefore even with low count values, plate count methods are only qualitative and require monitoring over time. They do not in themselves ensure absence of a variety of microbes that may be of concern.

**V. HPW AND ADW Systems Test Failure and Mitigation:** Failure conditions shall be corrected and tests repeated. The condition as related to all water quality parameters and equipment performance (e.g., ions, organic, particles, and microbial) should be reviewed when assessing test data. A deficiency in one parameter can often be indicative of the presence (or soon to follow presences) of other system faults. Therefore cause and interrelationship with other contaminants shall be considered in determining corrective action. If valid water sampling/analysis indicate failure to pass at least potable water requirements, tests shall be repeated at multiple sample locations, in duplicate, with successful results prior to use (inclusive of any required corrective

actions). If a valid microbial coliform, cyanobacteria, or other significant indicator test failure occurs, corrective action shall occur and the testing should be repeated multiple times (e.g., at least five samples within a 24 hour period) for the test site that failed, along with at least duplicate samples from other representative sample ports; all of which shall indicate no detection prior to use. Valid HPC and other microbial test failures shall be corrected and repeated in duplicate at representative locations as required to ascertain satisfactory microbial quality. Failures of ionic or TOC contaminants shall be traced, corrected, flushed, and tests repeated. TOC failures typically require subsequent microbial testing. If failures are associated with deep rooted biofilms and associated mitigation efforts (existing systems), ongoing rigorous monitoring is required.

***Rationale:** A favorable test result of a single or even duplicate test may not in itself be representative that the problem has been cleared, especially considering the nature of water sampling, sensitivity of techniques, and biofilm factors. Long term water quality trends should therefore be monitored and failures closely investigated.*

# Appendix 0

## Specialty Labs

---

### Contents

Appendix O.1 Insect Facilities

Appendix O.2 Electron Microscopes and Nanotechnology



# Appendix 0.1

## Insect Facilities

---

### Contents

#### 1.1.0 Introduction

##### 1.1.1 Facility Containment Purpose

##### 1.1.2 Arthropod Containment Level (ACL) Definitions

##### 1.1.3 Facility Design

##### 1.1.4 Planning Considerations

#### 2.1.0 Basic Requirements

##### 3.1.0 Architectural Design

##### 3.1.1 Heating, Ventilation and Air Conditioning (HVAC) Design

##### 3.1.2 Plumbing Design

##### 3.1.3 Electrical Design

## 1.1.0 Introduction

This chapter addresses the design of insectary facilities at the NIH. An Insectary is a facility where insects are housed, reared, and/or genetically modified.

Insects are one Class of the animal Phylum Arthropods. Most insects are not intrinsically dangerous but they can be a public health concern when infected with a pathogen, genetically modified or become invasive to an ecosystem. NIH researchers study a limited variety of insects, primarily insects such as mosquitoes, flies, fleas, etc., as vectors (carriers) of viruses that can be transmitted to vertebrates via bites.

A major health and safety concern in an insectary is the inadvertent release of infected, genetically manipulated, or invasive insects into the environment. Insect containment must be managed by using carefully controlled procedures in a facility that is designed well.

For the purposes of this document, all life-cycle stages, eggs, larvae, nymphs, adults must be considered under the term insect.

The principles described in this chapter can be applied to the design of facilities for other flying or biting arthropods if containment is required. Insectaries shall be designed for their safe, secure, and efficient handling and containment control. In addition to facility and species-specific requirements, systems shall comply with the appropriate sections of the NIH Design Requirements Manual (DRM).

### 1.1.1 Facility Containment Purpose

Insect facilities shall be designed with all biocontainment, safety, and security measures required for controlling and containing the insects of interest as well as any infectious agents, hazardous materials, or animal models used in the studies.

Containment is important for a number of reasons, including:

**A. Infected Populations:** Infected insects become an effective and unpredictable mobile vector for the agent of interest and shall be considered a biohazard. Facilities

with infected insects shall be designed with appropriate safeguards to ensure the safety of staff and the public from infection, including safeguards from escapes.

**B. Invasive Species:** Some insects may not be native to the area where they are being studied. Escape of either infected or uninfected insects could result in the establishment of an invasive species, with negative implications for the native environment. Containment measures shall be determined based, in part, on the likelihood of an invasive species becoming established as determined by the risk assessment.

**C. Genetic Modifications:** Genetically modified organisms (GMOs) are organisms whose genetic material has been artificially modified to change their characteristics, thus they raise the same concerns as invasive species.

**D. Native Species Incursion:** Incursion of native insects can disrupt research and affect characteristics of the laboratory colony. Steps shall be taken to ensure that native, local insects do not invade the facility.

### 1.1.2 Arthropod Containment Level (ACL) Definitions

Arthropod Containment Guidelines, published by the American Committee of Medical Entomology (ACME) of the American Society of Tropical Medicine and Hygiene<sup>1</sup>, define the characteristics of four containment levels that are somewhat analogous to the Biological Safety Levels (BSLs) defined in the Biosafety in Microbiological and Biomedical Laboratories (BMBL)<sup>2</sup>. They are both focused on the risks and safety considerations related to working with particular pathogens.

The BMBL summarizes ACL levels as follows:

*Four Arthropod Containment Levels (ACL 1 – 4) add increasingly stringent measures and are similar to biosafety levels. The most flexible level is ACL-2 that covers most exotic and transgenic arthropods and those infected with pathogens requiring BSL-2 containment. Like BMBL, each level has the following form:*

- *standard practices;*
- *special practices;*
- *equipment (primary barriers);*

- *facilities (secondary barriers)<sup>2</sup>*

*The first step in the design of an insect facility is determining the ACL levels of its components by conducting a risk assessment. As stated in the Arthropod Containment Guidelines, “risk” implies the probability that harm, injury, or disease will occur among laboratorians or the general public because of an accidental release of a competent vector and/or associated agents.<sup>1</sup>*

This document will focus on ACL-2 and ACL-3 facility requirements.

---

### 1.1.3 Facility Design

The success of an insect facility is dependent upon an efficient design as well as the procedures, and operations conducted by the staff which is defined by risk assessment and documented in the Standard Operating Procedures (SOPs). The facility shall be designed to enable the staff to conduct procedures and operations efficiently, safely and simply to reduce errors.

An insect facility encompasses more than just the rooms where insects are reared, housed and manipulated. The design of the facility should consider all of the facility’s functional aspects, including security; containment; flow of people, materials, and equipment; maintenance; decontamination; waste management and operation; and support functions.

---

### 1.1.4 Planning Considerations

An essential early planning activity is information gathering and the development of a Basis of Design (BOD) document. The BOD documents all key parameters of the project, including the species and varieties of insects to be used, procedures to be performed, security and containment requirements, equipment to be used, environmental parameters to be maintained, standards and regulations to be met, and all other factors that will have an impact on the facility design, maintenance, and operation.

SOPs should be developed at this time which will define operational functions including standard and unusual scenario procedures, flow through the facility (of people,

materials and insects), decontamination methods, PPE requirements, and other procedures, processes, and activities that occur within the facility.

In planning the insectary, the designer should obtain clear answers to the following questions:

- Is the insect native to the locale?
- Is the insect an exotic variety?
- Will the insect be genetically modified (GM)?
- Will multiple insect species be housed and manipulated in the same facility?
- Will the facility be used in the future for other insects?

If the answer to any of these questions is YES, then it is necessary to conduct a site-specific risk assessment and base the design on the appropriate United States Department of Agriculture Animal and Plant Health Inspection Service (APHIS) containment (ACL 1-4) criteria, keeping flexibility to house other insect species in mind.

Some of the important aspects to designing any insectary is understanding the variations and critical boundaries of temperature for the desired species, lighting and humidity requirements, species-specific life cycle characteristics and the level of containment required based on the risk assessment.

General considerations for planning an insect rearing facility include:

- Level of Containment (ACL 1-4)
- Site selection within the existing facility
- Process, product, feed delivery, and staff flow
- Storage of equipment and consumables and warehouse space for sufficient stocks
- Species-specific food production
- Water quality needs
- Quarantine of incoming stocks (i.e., how many generations need to be quarantined and what type of space is required). One solution is to quarantine in a dedicated incubator isolated from other populations.
- Backups for equipment, processes, and utilities
- Balancing requirements and costs for automation versus manual labor

- Balancing investment and future energy efficiencies and maintenance costs
- Waste treatment, disposal, and impact on the environment
- Requirements for research, quality control, hygiene, staff amenities, and occupational health and safety
- Presence of odors, volatile organic compounds (VOCs), and contaminants
- Noise and vibration, as it might affect the insects
- Accommodation for facility flexibility and growth
- Vertebrates used for studies. Animal models may be used to mimic the disease manifestations observed in humans, and may include non-human primates, mice, swine, or rabbits depending on the disease of interest. Containment facilities for the host animals ideally should be separate but near or adjacent to the insectary. The need for host animals, including animals needed to maintain colonies, means that the facility where they are housed has a loading dock for delivery and designated routes of transport.

Species-specific biological factors to consider for all insect rearing facilities include:

- Life cycle requirements for immature and adult stages
- Parameters required for maintaining a healthy colony, including egg collection
- Diet and food ingredients (larval and adult) including media to grow the larvae in (fruit, artificial diet based on fruit, or a totally artificial diet)
- On-site or remote food preparation
- Temperature and humidity needs at various life cycle stages
- Dawn-dusk (crepuscular) lighting
- Housing type
- Scale of production (may impact degree of automation built into the facility)
- Production level required, including colony stock and parental colony
- Production schedules
- Forecast volumes for each of the products (egg, larvae, pupae, and adults)
- Sexing strain or non-sexing strain

- Strain production profile - biological profiles (e.g. egg to pupae recovery) of each strain to be reared
- Strain quality control specifications (varies between strains and species)
- Schedule and sequence of flow of biological materials through the facility
- Requirement for active environmental monitoring

Collecting the above information will inform a risk assessment to base the design on the appropriate APHIS containment (ACL 1-4) and set procedural and programmatic requirements for the facility.

---

## 2.1.0 Basic Requirements

This section covers basic requirements for insect facilities.

**A. Environment for Insects:** A primary function of an insect facility is the rearing and housing of healthy live specimens throughout their life cycles. Detailed requirements are species and life-stage specific, but insects generally thrive in humid, warm environments. Other considerations include light levels, air movement, air quality (e.g. presence of odors, VOCs, and contaminants), noise, and vibration.

Appropriate environmental conditions can be achieved in an entire room where the insects are housed in simple screened containers which are open to the room environment. This maximizes the capacity potential of the room, but requires that the entire room be warm and humid. These conditions are conducive to corrosion, condensation, and mold. A disadvantage to this strategy is that the room will be an uncomfortable working environment for staff.

An alternate strategy is to provide suitable warm, humid microenvironments in enclosures within a more normally-conditioned room. Microenvironments shall be designed to provide optimal conditions for the insect species. Environmental chambers, incubators, or other enclosures can provide microenvironments suitable for insects in a room that is more comfortable for staff. Another advantage of enclosures is that they provide an additional level of containment between insects and staff. See [Figure 2.1.0](#).

**B. Environment for Staff:** Staff comfort shall be considered. Outside of rearing and housing areas, temperatures and humidity should be appropriate for staff, taking into account that staff may need to wear PPE. There should be an area for lockers and donning/doffing PPE in, or adjacent to, the entry/exit vestibule. Depending on the size and function of the facility, changing rooms, break rooms, meeting rooms, toilets, and showers should be conveniently located. Staff areas can be made more appealing with windows, comfortable furniture, and other amenities.

**C. Environment for Research:** Air exchange rates shall be determined based on the procedures to be performed, the quality of air required, and the ACL/BSL level of the facility. High air exchange rates can cause turbulence that may disturb insect manipulations, so the locations and types of air devices shall be designed to limit air movement to acceptable levels. Airflow, distribution, and differential air pressurization between holding, laboratory, and staff areas of the facility shall be controlled as a key component of containment. The temperature and humidity of rooms with microscopes and other sensitive equipment shall be maintained within limits established by the manufacturer. Temperatures necessary to manipulate insects can be achieved using local cooling plates, while the surrounding temperature remains at comfort levels for staff.

**D. Environmental Systems Requirements:** An insect facility places very high demands on the environmental systems. Systems shall be designed to provide and maintain a range of pressurization, humidity, temperature, and air exchange rates in the rooms within the facility. Systems shall have adequate redundancy and back-up capacity to maintain operation through all likely failure scenarios.

Ideally, all systems should be designed so that maintenance work can be performed to minimize entry into the facility. Valves, dampers, filters, and other items requiring access should be located in an interstitial space or other area outside of the ACL facility to eliminate disruption to operations and risks to containment. The boundary of the ACL facility should be determined by risk assessment and clearly marked with signage so that maintenance staff recognize the perimeter of the facility and where PPE or other safety measures are required.

**E. Security:** Measures shall be taken to ensure that insect facilities are not accessed by unauthorized or

untrained personnel. Facilities in a larger building should not be located in prominent or high-traffic areas, and should ideally be accessed by a corridor that is ‘staff only’ or already has a level of access restriction.

The main entry door to a facility shall be provided with access control (e.g. locked with biometric or card-key access for authorized staff only). Doors to sensitive rooms within the facility (e.g. infected, transgenic, GMO) shall have additional access control measures.

Signage shall be provided with biohazard information, ACL-level, PPE requirements, and other notifications.

**F. Containment:** Facilities shall be designed with the appropriate multiple levels of containment to prevent escape. All insect facilities shall have basic control precautions, including directional airflow, insect traps, and screening (sized appropriately for the insects of interest) on all openings (including air and vacuum devices, faucets, drains, and doors). Air curtains and other containment devices should also be considered.

Insect escape prevention and enhanced recapture requirements include:

- Air-showers for blowing off insects
- Any openings into the room (e.g., air ducts, lights, plumbing fittings, electrical conduit) shall be suitably screened or sealed
- Use capture devices (e.g., UV light electrocution traps, sticky traps)
- Waste disposal outlets shall be provided with appropriate filtration (e.g. a fine-mesh sieve) to ensure the retention of the smallest eggs, larvae or other stages of insects in waste water or washings and to permit safe disposal of all solid waste.
- As required by risk assessment, all waste exiting the facility shall be appropriately decontaminated, sterilized, or otherwise rendered non-hazardous.
- Avoid crevices or equipment (e.g. humidifier) that could contain unmonitored sources of open water.
- Windows and other outlets of rooms leading off an insectary should be screened against flying insects.
- Where insects carry pathogens, fail-safe cages should be used (e.g. use of safety cabinets for flying insects or cages over trays of oil or glycerin for crawling insects).
- Protective clothing and facemasks should be

**Figure 2.1.0 Containment Levels** (Note: Temperature and RH are illustrative and should be designed on case by case basis.)

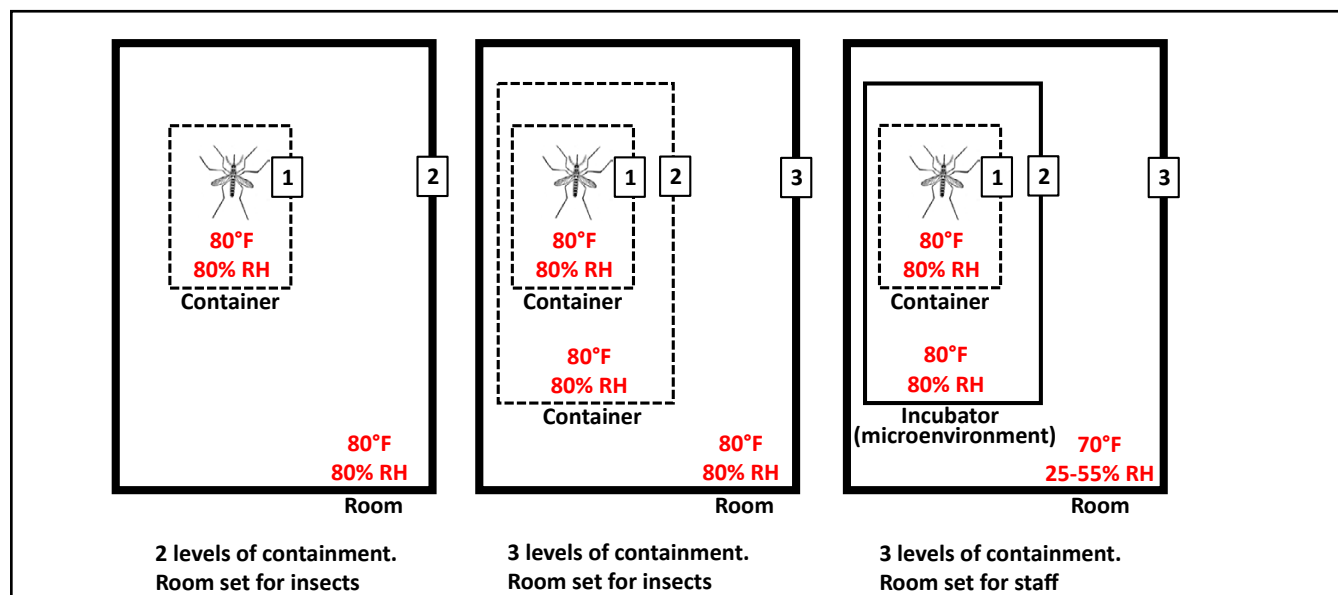

provided as necessary to avoid inhalation of pathogenic organisms in dust and other allergens or irritants.

**G. Containment Levels:** The number and types of levels of containment shall be based on ACL-level and risk assessment. Containment can be a single sealed container, which may be adequate for an ACL-2 environment. A second level of containment can be an additional container or incubator, which may be required for an ACL-3 environment. The next level of containment is the room (see Figure 2.1.0). A final level of containment consists of the intervening spaces (including corridor and vestibule) between the room and public areas.

The required levels of containment shall be maintained when moving or manipulating insects. Biological safety cabinets, glove boxes and other containment devices may be required.

**H. Cleaning and Decontamination:** The facility shall be designed to allow for routine cleaning and decontamination as required by risk assessment and SOPs. Wipe-down with cleaning agents is required in all spaces, and all surfaces shall be water and chemical resistant. Some rooms may be required to undergo gaseous decontamination or fumigation, so finishes and penetrations shall be sealed and systems shall be segregated and detailed appropriately. All exposed surfaces should be capable of withstanding regular exposure to cleaning

and decontamination products without degradation. It is important to determine what type of cleaning, disinfecting, and decontamination products will be used in the facility in order to correctly determine surfaces and finishes. Consideration should be given to means of decontaminating equipment.

**I. Flexibility:** When designing an insect facility consideration should be given to making it functional for the study of multiple or future species and various life cycle stages. Species-specific equipment can be installed if fixed items are minimized and rooms are sized and configured for flexibility.

Environmental systems should be designed so that they can be modified to meet specific requirements.

**J. Testing and Certification:** The facility may have to be tested and verified to ensure design and operational parameters have been met.

### 3.1.0 Architectural Design

**A. Functional Organization:** Typically, the insectary is designed as a suite and should be configured as a sequential series of rooms based on the risk assessment beginning with the entrance door. Functions should be located so that security and containment increase as one moves progressively through the facility. Similarly,



Figure 3.1.0 Conceptual Insectary Airflow and Pressurization Diagram

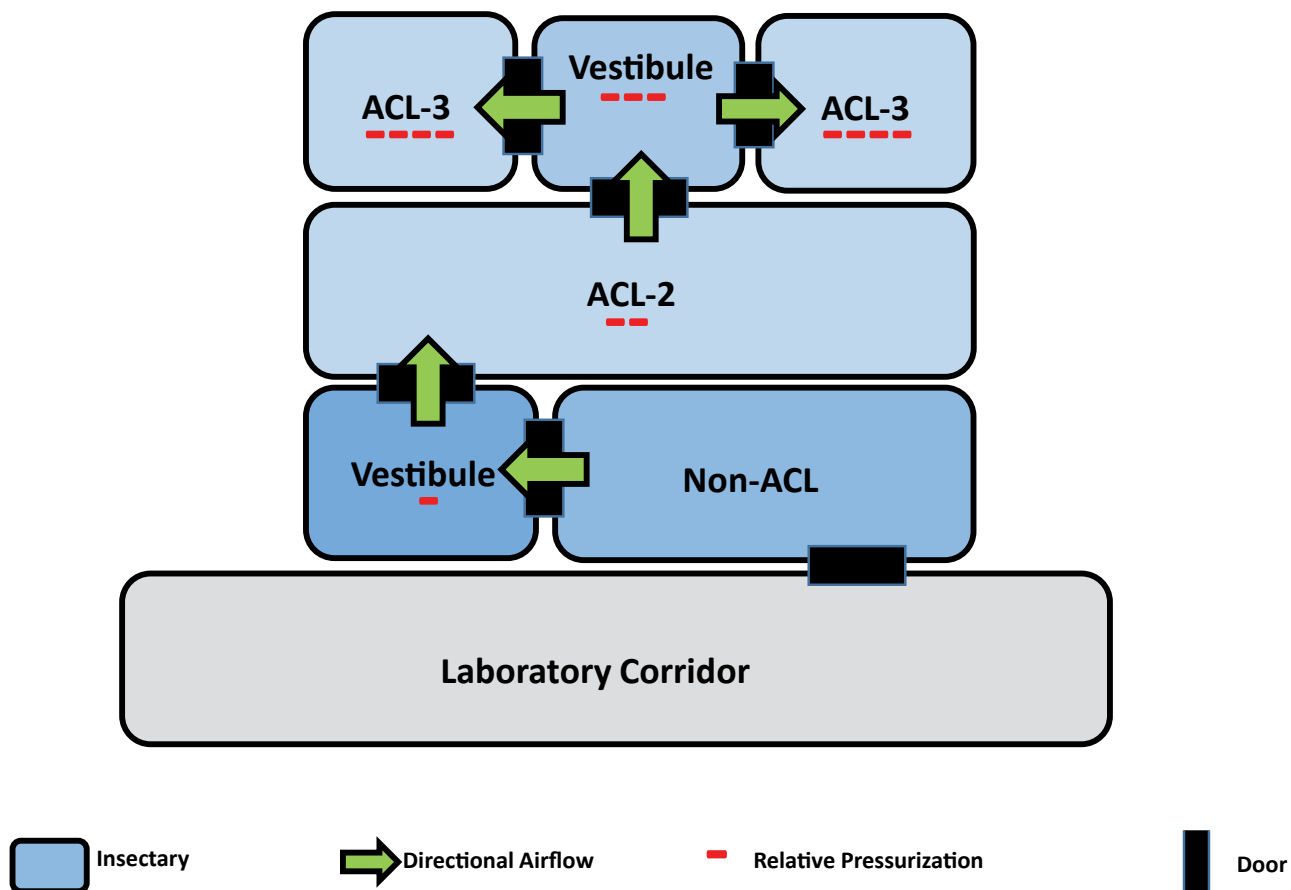

negative air pressure increases as one moves through the facility (see Figure 3.1.0). The entrance door and subsequent corridor, vestibule, and room doors shall have appropriate signage and access control, allowing access to only appropriately trained and authorized staff.

The flow of people, materials, insects, and waste should be considered when configuring a suite with the goals of minimizing traffic, cross contamination, and unnecessary movement of insects and hazardous material.

**B. Functions:** Insect facilities are used for a number of specialized procedures and tasks. These include but are not limited to: studies with infectious agents, quarantine, rearing and breeding, holding, manipulation, irradiation, food preparation, cleaning, decontamination, and autoclaving. Depending on the size of the facility, ACL-level, and other factors, these procedures and tasks may be conducted in individual rooms, or some compatible procedures and tasks may be combined in multi-purpose rooms. All functions, however, shall be

reviewed with facility users and operators to determine requirements.

1. **Vestibule:** The vestibules serve as containment barriers and access control points. A risk assessment will determine the locations of vestibules, but they are generally required at ACL-3 rooms, and may be required at ACL-2 rooms and at the entrance to the facility. Vestibules have two self-closing doors which are interlocked physically or by SOP procedures. Vestibules shall have all equipment necessary to support required entry and exit procedures, which may include hand-washing sinks, lockers, PPE racks and disposal bins, benches, mirrors, signage, etc. if used for PPE. ACL-level and SOPs may require additional staff support functions in or adjacent to the vestibule, including changing rooms and showers. Temperature and humidity should be set for staff comfort.

2. **Manipulation:** Manipulation rooms are where individual insects are handled, examined, or undergo procedures. Insects may have to be immobilized, anesthetized, or euthanized. Rooms require handwashing sinks with eye-washes, and may require microscopes, specialty gasses, refrigerators, incubators, work tables, chill tables, glove boxes, biological safety cabinets, and other program-required equipment. Temperature and humidity should be set for staff comfort. An autoclave, or access to an autoclave, shall be required for the disposal of hazardous biological material.
3. **Holding:** Holding rooms are where insects are bred, reared, and maintained. A quarantine room for insects entering the facility for the first time is a specialized holding room and should be located away from experimental rooms. The degree of containment for the quarantine room requires special consideration. Insects may be held in micro-environments (e.g., an environmental room or incubator). The temperature and humidity shall be set for staff comfort in that case.

For mosquitos and other blood feeding insects, proximity to a holding room for host animals may be required. Host animal holding rooms should be in close proximity to manipulation rooms to limit the transport distance; however, precautions must be taken to protect host animals. Exterior windows are not desirable. Considerations include:

- a. If walk-in environmental chambers are used, the slab should be depressed to compensate for the chamber's floor thickness and eliminate ramps.
  - b. Seal and provide expansion joints at junction between prefabricated and site-built assemblies to maintain containment barrier.
  - c. Host animals should be housed in a separate location to avoid potential contamination. The animal facilities shall meet the requirements set by the Association for Assessment and Accreditation of Laboratory Animal Care International (AAALAC) and the NIH DRM.
  - d. Infected and genetically modified insects may be in a single room or in a suite of rooms. These shall be the most negatively pressurized rooms in the facility with the highest levels of security and containment. Infected and genetically modified insects should be physically separated from 'normal' insects and from vertebrates. Special requirements may be needed for PPE and direct access to an autoclave.
4. **Laboratory Equipment and Support:** Support spaces can include refrigerators and freezers, ice machines, autoclaves, support equipment, feed preparation areas, vertebrate animal care and housing, and other functions directly supporting the activities in the Holding and Manipulation rooms. Laboratory equipment rooms and support spaces should have laboratory-type finishes and services.
  5. **Autoclave:** An autoclave shall be accessible for any ACL facility, and a pass-through autoclave shall be at the containment perimeter of ACL-3 facilities.
  6. **Staff Support:** Consideration should be made for the comfort and convenience of the staff. Lockers should be provided in the entry vestibule and changing rooms adjacent to the vestibule if required. Depending on the size of the facility, a training room, break room, toilets, showers, and other staff support spaces maybe provided, located off of or adjacent to the entry vestibule.
  7. **Storage:** Rooms shall not be cluttered to avoid opportunities for insects to hide. All items not in active use shall be stored. Storage rooms should be in close proximity, and of sufficient size for supplies to allow continuous operation without disruption.
  8. **Wash Room:** The wash room provides for the washing and storage of rearing and holding containers. The room should have a large, deep, stainless steel sink with dishwashing-type hose, shelves, and a floor drain. All materials and finishes should be appropriate for wet locations.

9. **Janitor's Closet:** To limit access to the facility, housekeeping in the facility may be done by facility staff. To limit the impact on the insects, special cleaning procedures and products may be required. Consideration should be made for a dedicated janitor's closet, cleaning tools, and products.
10. **Cylinders:** Specialty gasses may be required. A cylinder room located immediately outside of the insectary will allow gasses to be piped to appropriate locations in the containment area, but will also allow the cylinders to be changed without entering the facility.

### C. Finishes and Furnishings:

1. Walls should be white (smooth finish and without pattern or accent) to make insects visible. Walls shall be monolithic or panelized with sealed joints and impervious to cleaning and disinfection agents. Wall surfaces should be highly resistant to impact damage or should have protection rails or protective sheet covering. Inside and outside corners should be eased and coved to promote cleaning and to minimize hiding places for escaped insects. All wall-mounted devices (outlets, switches, monitors, diffusers) shall be sealed and flush, and all openings protected with fine insect screening. In rooms with high temperature and humidity levels, all components of construction shall be non-organic and mold-resistant, appropriately thermally insulated, and detailed to prevent condensation.
2. Interior windows should be used wherever possible to visually connect rooms and to allow activities to be observed without entering.
3. Exterior windows should be considered in appropriate rooms as a staff amenity. They should not be used in rooms with diurnal lighting, where they may compromise security or containment, or in rooms with high humidity or temperature.
4. Floors should be white to make insects visible. Floors shall be monolithic and impervious to cleaning and disinfection agents. Floors shall be installed with integral coved bases. Wheeled traffic, high equipment loading, presence of water, and frequency of cleaning should all be considered when selecting floor systems. Resinous epoxy and welded vinyl are recommended flooring materials. Floors in rooms containing water and subject to wash-down should have floor drains with fine screens. Environmental rooms with thick floors should be recessed into the structural floors to eliminate ramps.
5. Ceilings shall be low enough that mosquitos cannot fly out of reach, but tall enough that lab equipment such as biological safety cabinets can be installed and function properly. Ceilings should be white to make insects visible, and shall be impervious to cleaning and disinfection agents. Ceilings shall be monolithic, or panelized with sealed joints. All ceiling devices (lights, diffusers, strobes) should be sealed and flush, and all openings protected with fine insect screening.
6. Doors of solid construction are preferable. If hollow doors are used, they should be continuously welded so that the cores are sealed and inaccessible. The tops and bottoms of doors should be flush, without recessed channels. Doors and frames shall be impervious to cleaning and disinfection agents. Doors should be white fiberglass reinforced plastic (FRP) or steel painted with durable high-performance coating. Doors shall be self-closing, and may be automatically operated or interlocked, depending on location and function. Seals and bottom sweeps should be considered to control air flow and to serve as insect barriers. Vision panels in doors shall be used wherever possible to give the facility a greater sense of openness, and to allow activities to be observed without entering a room or vestibule. Vision panels in doors into rooms with diurnal lighting can be fitted with hinged or sliding light-tight covers.
7. Retracting screen or hinged screen doors should be considered as an added barrier at doors and openings, or to compartmentalize rooms or corridors. If screens are used, the mesh size should be determined by risk assessment.
8. Fixed casework should be minimized, particularly in rooms subject to frequent cleaning and disinfection. When storage or shelving

is required, mobile units should be considered before fixed casework. If required, fixed casework should be white and shall not have voids, crevices, or concealed spaces. White phenolic resin and epoxy resin are preferred materials for bench tops.

9. Furniture should be mobile for flexibility and to promote cleaning and decontamination. Fabric shall not be used on seating. Furniture should be white and shall not have voids, crevices, or concealed spaces. Shelving systems should not have standards with unsealed voids or holes.
10. Many interior materials, including wall and floor materials, can contain high levels of VOCs, which can take several weeks to be flushed out by the HVAC system before it is safe to bring the insects into the facility. This shall be taken into consideration when commissioning and scheduling the completion of the facility.

**D. Equipment:** Specialized equipment may be required, especially in rooms where insects are manipulated. Equipment will be specific to the program and procedures performed, but may include the following:

- Dissecting microscopes (stereomicroscopes) suitable for fluorescence analysis with either fiber-optic transmission from a distant light source or LEDs to avoid overheating of the insects. For dissections, flexible optical fibers mounted directly on the microscope are recommended.
- Irradiation equipment: gamma, electron beam, X-rays. Consider security risks and public concern associated with radioactive sources, irradiation equipment, its transport, need for appropriate attenuation of walls and floors, and volume of insects to be irradiated daily.
- A purpose-built glove box that has no air flow may be used for ACL-3 insects.
- Equipment to dispose of insects that are of no use or have been dissected. This may include 70% alcohol filled bottles; autoclave.
- Insect traps
- Equipment for sterilization or disinfection of solid and liquid waste possibly contaminated by pathogens or infected insects
- On-site freezer (-20 °C) to kill insects

### 3.1.1 Heating, Ventilation and Air Conditioning (HVAC) Design

**A. Systems Requirements:** As in any research laboratory design, temperature, humidity, pressurization, directional airflow, and filtration are determined by the risk assessment, species, and type of research.

For these purposes, the mechanical systems serve a number of important functions, including comfort and safety of staff, optimal environment for insect life stages, and containment of insects and infectious agents. Risk assessments shall be performed to identify potential hazards and appropriate safeguards, which shall be included into the design of the HVAC systems.

Mechanical systems shall be designed to maintain a range of temperatures, humidity ranges, air-change rates, and differential pressures in and between the rooms within the facility. As addressed in [Chapter 6: Mechanical Design](#), systems require redundancy and back-up capacity to maintain operation through all plausible failure scenarios. Systems shall be designed so that all maintenance work can be performed without entering the facility. In addition to facility-specific requirements, systems shall comply with the appropriate sections of the NIH Design Requirements Manual (DRM).

**B. Environmental Conditions:** Rooms containing insects in open or screened containers shall be maintained at a temperature and humidity optimal for insect development and subsistence. Rooms containing insects in microenvironments (e.g. incubators or environmental enclosures) can be maintained at a temperature and humidity optimal for staff. The approach used will depend on the operation of the facility and the determination of the risk assessment. Under no circumstances can the environment overheat, undercool, or freeze. Controls devices include the following:

1. Monitoring of air pressure differentials between filtered and unfiltered air (e.g. monitors for filter replacements) shall be provided.
2. Sensors in each rearing room to monitor the room temperature, RH and levels of CO<sub>2</sub> should be provided.
3. Alarms triggered whenever the temperature

or humidity is not maintained within a range appropriate to the species.

4. A parallel and independent monitoring system shall ensure accurate readings provided by the primary system.
5. Provisions to facilitate calibration of sensors should be considered.
6. Remote as well as a local monitoring system for lighting control.

**C. Temperature:** The temperature of the insectary rooms will vary depending on the room activity.

1. Rooms containing insects in open or screened containers may be maintained between 72 - 80°F (22 - 27°C), the actual temperature to be determined by the species and development stages.
2. Consider electronic digital thermostats that maintain temperature within one degree of set point. Consider selecting temperature sensors without covers, or provide mesh to prevent harboring of insects inside the air circulating vents through the thermostats.
3. Rooms containing insects in microenvironments can be maintained at comfortable levels for the staff, as recommended by the DRM for laboratory applications. Staff may be wearing PPE, so room temperatures should be maintained appropriately.
4. Some facilities may have designated rooms/areas capable of achieving colder temperatures, preferably below 50°F to immobilize insects and prevent escapes. These rooms/areas shall be designed to minimize the opportunities for the mosquitoes to hide and to facilitate the collection of escapees. When designing this area, consideration shall be taken to avoid the potential for condensation resulting from being adjacent to warmer areas.
5. When performing HVAC calculations, consider thermal loads of different rooms such as raw ingredients for insect diets, microbial loads, types of equipment, insect species and stage of development, number of trays, human activity levels, etc. that will impact the size, type, and

design of the heating/cooling systems, room ventilation requirements, pressurization, etc.

**D. Humidity:** The relative humidity (RH) in rooms containing insects in microenvironments can be maintained within 25 to 55%, depending on the type of research or the risk assessment.

Rooms containing insects in open or screened containers may require RH up to 80%, which may require using steam humidifiers or a stand-alone humidification system.

Conditional to the HVAC system, a dedicated humidifier may be installed in the supply air duct serving the mosquito rearing areas, providing constant uniform and dependable room humidification.

As there are many species of arthropods which may require specific environmental conditions, consideration should be made when selecting humidity control systems, including humidity control sensors. The controls system should be capable of measuring the relative humidity within the range of 20 to 100%, allowing users to set minimum and maximum alarm level notifications within a 3% maximum variation.

Since moisture is being added to the air inside the insectary, strict housekeeping practices will be needed in rooms with higher than normal temperature and humidity to prevent corrosion and mold growth.

**E. Air Exchange Rates:** The HVAC system shall maintain an air exchange rate between 6 to 15 air changes per hour (ACH). The resulting air changes per hour (ACH) shall be determined by the risk assessment as appropriate for the procedures conducted and the infectious agents used. The impacts of a high ACH shall be balanced against the resulting air velocity and turbulence, which can make the manipulation of lightweight insects difficult. HVAC system design should include low velocity supply and return/exhaust air and/or provide low flow or laminar flow air devices.

**F. Ventilation:** Ventilation shall be appropriate for insect maintenance, but shall not compromise containment.

1. All exhaust air devices require filters/barriers to prevent entry of insects into the ventilation system. The exhaust system should be designed to promote inspection for errant insects.



2. The direction of airflow shall be maintained towards the innermost room to prevent escapes and provide containment. A progressive negative pressure gradient is required as distance from the entrance increases.
3. A dedicated HVAC system is required to allow for shut-downs and decontamination and to prevent escapes.
4. When pathogens or hazardous agents are utilized, or when required by the risk assessment or BMBL, HEPA filters shall be installed in the exhaust system. Exhaust air discharge shall be per [Section 6.2.3 Outdoor Air Intakes and Exhaust Air Discharge](#).
5. Seal connections in air ducts, vents, equipment plenums, conduits, and all other penetrations and openings.
6. Air curtain(s) located in the doorways of vestibules and internal corridors can be used to help prevent the escape of flying insects.

**G. Airflow Direction and Pressurization:** Airflow and pressurization are key components of containment of both airborne insects and aerosolized agents. The risk assessment, based on the functions of individual rooms, shall determine the levels of airflow and pressurization required. All rooms shall become increasingly negatively pressurized from the entry as staff and/or visitors move progressively into the suite. Rooms containing infected, genetically modified, or otherwise hazardous insects or agents shall be the innermost rooms within the facility and have the greatest negative pressure.

1. **Vestibules:** The ventilation of vestibules shall be balanced to ensure that the exhaust from the containment area is adequate to maintain inward airflow (negative pressure) towards the containment area to prevent escapes. Air curtains should be considered to both control escapes and prevent the intrusion of local insects.
2. **Holding Rooms:** Insects are bred, reared, held, and fed in various types of holding rooms.

The airflow shall be balanced so negative pressure or negative airflow is maintained in relation to the vestibule or corridor.

If open or screened containers are used, the ambient conditions shall be maintained at a temperature and humidity optimal for insect development and subsistence. The airflow quantities shall be determined by the required air changes per hour (ACH) necessary for safety and containment.

If microenvironments are used, the ambient conditions and airflow in this room can be maintained to comfortable level(s) for the staff. The airflow quantities shall be determined by the required air changes per hour (ACH), by heating and cooling requirements, and as needed for safety and containment.

3. **Manipulation Rooms:** Manipulation rooms are where individual insects are handled, examined, infected, genetically modified, or treated.

The ventilation to these rooms shall be isolated from all other areas of the insectary (dedicated), as pathogens and other hazardous materials may be used. Environmental conditions shall be set for occupant comfort. The air exchange rate and the location of air devices shall be considered to prevent excessive air movement over the work area. This room may be equipped with biosafety cabinets with HEPA filters, glove boxes, or other containment devices. If the manipulation room is classified ACL-3, the ventilation shall be designed to include an autoclave, and may be the most negatively pressurized room in the facility.

**H. Reliability:** The HVAC systems shall operate with a high degree of dependability. Components shall be configured to allow for properly scheduled preventative maintenance without disruption of operations. This is usually achieved by locating all equipment and components requiring service and maintenance in an interstitial space above the facility, or in mechanical rooms adjacent to the facility. Redundancy and emergency power shall be provided and shall comply with the appropriate sections of the NIH Design Requirements Manual (DRM) to ensure continuous operation through failure scenarios.

**I. Filtration / Containment:** Both the intake and exhaust filtration systems shall be evaluated. The intake filtration system shall be designed to control air quality.



The exhaust filtration shall be designed to prevent insect escape and provide the ability to recover errant individuals.

Install the following screens or filters associated with the air systems:

1. Internal exhaust vents shall be provided with stainless steel 80 Tyler Equivalent mesh screens. This filtration system will assist in the recovery of escapees.
2. When the research requires manipulation of pathogens and as determined by the risk assessment, a 99.7% efficient HEPA filter capable of retaining particles of 3 microns may be required. The HEPA filter may be part of a biosafety cabinet.
3. If required by the risk assessment, the outside air intake may require protection against foreign particles or organisms that can negatively impact the facility. HEPA filters with 99.97% efficiency will contain outside particles as small as 3 microns.
4. The supply air shall be appropriately screened, whether the HVAC system is recirculated or 100% outside air. The risk assessment will determine the filtration system requirements based on the particles of concern. Serious consideration should be given to the possible scenario of control or mechanical failure in the HVAC system that can create unexpected airflow reversal.

Install filters and screens in the HVAC system so the internal components can be easily cleaned, decontaminated, and replaced as needed.

Install parallel filters, or other configurations that allow one filter to be replaced while the system remains in operation.

**J. HVAC Control and Monitoring:** Local and remote HVAC monitoring systems are required to ensure optimal environmental conditions and to provide adequate notification of deviations from the set point and range. A well-designed environmental HVAC control system continuously monitoring environmental conditions and the HVAC components can provide notification of conditions otherwise difficult to detect, such as airflow reversal or malfunction of systems.

## 3.1.2 Plumbing Design

**A. General:** The plumbing systems shall be subject to review and approval by the authority having jurisdiction and shall be in accordance with an approved risk assessment. There shall be no uncontrolled escape paths for any stage of life of insects through piping networks. The design and installation of a plumbing system shall consider all containment level requirements, types of insects, pathogens and associated agents being used, and proper disposal of all waste. The risk assessment may require sterilization of effluents from the facility with steam or its equivalent before releasing them into the sanitary sewer system. In areas where potentially fatal arboviruses are handled, such as ACL-3 and ACL-4, infected or uninfected arthropods can be destroyed by freezing or by using readily available heat. A sink with local heat such as an instant-hot water generator (120°F to 140°F [49°C to 60°C]) may provide the necessary heat, followed by proper disposal through a fully plumbed chemically treated holding tank or heat treatment capable of killing insects at any stage.

**B. Sink and Shower:** A hand washing sink shall be accessible when entering and exiting the facility, and at other locations as required by the risk assessment and operational SOPs. Hands-free operation may be required.

A housekeeping sink in the janitor's closet shall be installed within the facility for cleaning. The housekeeping sink should be provided with cold and hot water.

Sinks shall be provided without overflows.

All drainage fixtures shall be provided with tight fitting double-layer stainless steel screens with openings sufficiently small to prevent escape (but no larger than #52 mesh) and free of sharps hazards.

The risk assessment may require contamination control such as shower facilities as part of entry or exit protocol.

The risk assessment may require fixtures to be connected to a bio-waste system.

**C. Domestic Water:** The chlorination process of potable water can be harmful to insects, especially during the aquatic phase of their life. The used of purified water may be required, especially in rearing rooms and for humidification systems.

**D. Emergency Fixtures:** The installation of emergency fixtures in insectaries shall be driven by the risk assessment. At a minimum, emergency fixtures shall be provided in accordance with the BMBL, NIH DRM, and the AHJ for each lab safety level.

**E. Floor Drains:** Floor drains should be avoided. Where required, floor drains shall be provided with screens as listed under drainage fixtures. Disinfectants utilized in trap seals shall be reviewed to ensure compatibility with system materials and elastomers.

If the risk assessment requires an effluent treatment system, only drainage systems that are fully controlled should be connected to maintain the validation of its efficacy. The release or exposure of personnel to untreated wastes shall not be permitted.

**F. Piped Services:**

1. **Vacuum:** The risk assessment may require HEPA filters in vacuum outlets (required in all ACL-3 facilities). Where HEPA filters are not required, screens or permanent point of use filter arrangements are required. If a central vacuum system is installed, each service outlet shall be fitted with suitable barriers/filters to prevent insect escape. Filters shall be installed to permit decontamination and servicing. Vacuum appliances shall be dedicated to the facility and not serve other areas of a building.
2. **Carbon Dioxide CO<sub>2</sub>:** CO<sub>2</sub> may be used as anesthetic to allow for manipulation of insects in a glove-box or on a chill table. These are some recommendations when using CO<sub>2</sub>.
  - a. CO<sub>2</sub> tanks shall be rigidly fastened to a wall or otherwise safely secured.
  - b. CO<sub>2</sub> tanks shall be fitted with a pressure reduction valve and an automatic switch-over between tanks allowing for continual operation. Considerations shall be made to provide CO<sub>2</sub> inline heaters to control regulator freeze ups resulting from sudden high flow of CO<sub>2</sub>. If required, a CO<sub>2</sub> temperature monitoring system shall be considered to coordinate with the HVAC system to maintain proper space temperature.

- c. When using a permanent and remote central CO<sub>2</sub> source, individual piping connections are recommended.
- d. An additional pressure regulator valve shall be installed at each workstation to regulate the supply pressure of CO<sub>2</sub>. Installation of CO<sub>2</sub> distribution systems shall comply with NFPA 99.
- e. CO<sub>2</sub> sensors may be required per [Section 12.3.6 CO<sub>2</sub> Lab Gas, Additional Requirements](#).

**3. Sterilization and Waste Disposal:**

- a. At a minimum, all rooms shall be designed for frequent cleaning, including wipe-down with disinfection agents.
- b. The risk assessment may require gaseous sterilization, in which case room design shall include appropriate materials compartmentalization, dampers, ports, and other details.
- c. At a minimum, an autoclave shall be available to all ACL-2 facilities, and shall be integrated into the containment barrier of all ACL-3 facilities. If available, the use of steam as the main source of heat for sterilization is preferred. Autoclaves shall have exhaust hoods to remove residual steam.
- d. All waste shall be transported from the facility in leak-proof, sealed containers for proper disposal in compliance with applicable institutional and federal, state, and local requirements. The risk assessment may require autoclaving prior to disposal.

---

### 3.1.3 Electrical Design

**A. General:** The design of the electrical systems shall meet the program requirements while incorporating NIH's commitment to sustainability and energy-efficiency. The electrical system for insectaries shall comply with the requirements for BSL-2 and BSL-3 laboratories. In addition, the electrical system shall comply with the following requirements.

**B. Power:** The normal power source at the NIH Campus in Bethesda is described in [Section 10.2.1 Electrical Power Distribution](#). The power distribution designed for insectaries shall follow the requirements in [Section 10.5 Wiring Methods and Other Requirements](#). In addition, electrical design for insectaries shall include the following:

1. Seal all wall and ceiling penetrations for electrical devices such as electrical boxes, receptacles, lighting, conduits, etc.
2. Junction boxes shall be cast and conduits internally sealed.
3. Provide additional electrical outlets to allow for flexibility for equipment growth such as incubators, freezers, and microscopes. The location for these outlets shall be coordinated with the user or researcher.
4. Provide ground fault interruptions devices in wet areas.
5. In addition to the life safety devices and equipment, emergency power may be required depending on the program requirements based on the risk analysis.
6. Provide receptacles connected to emergency power for equipment requiring continuous operation during power outages.
7. Emergency power serving life safety devices and equipment shall be designed per NFPA 72 and NFPA 110.

**C. Lighting:** Lighting requirements for insectaries shall meet the NIH DRM requirements for BSL-2, BSL-3 and ABSL-3. Lighting for insectaries shall be designed to promote a safe working environment for the researchers and ensure adequate habitat for mosquitos or other insects bred and maintained within the facility.

1. Light fixtures should be recessed and sealed to simplify capture of flying insects. Lamps with high color temperatures are preferred.
2. Use dimming control system to simulate dusk to dawn, achieving a 12hr light / 12hr dark cycle. These simulated lighting cycles shall be programmed/adjusted depending on the species or for specific insect research programs. Provide

programmable dimming control in rooms housing insects.

3. Illumination level shall be appropriate for insect maintenance but not compromise insect containment, impede vision, or adversely influence the safety of procedures within the insectary. Avoid openings with lower lighting level that attract escaped insects. (ACL-2)
4. High illumination levels (average of 100 foot-candles [fc]) shall be achieved in the manipulation and lab spaces. This level of illumination does not compromise vision or negatively influence safe performance of procedures within the manipulation room. More specifically, the NIH DRM requires that illumination level of insectaries with environmental chambers shall be designed between 40-50 fc (430-450 lux) @ 42in. (1067mm) AFF. For insectaries without environmental chambers, illumination level shall be between 25-75 fc (270-810 lux) @ 36in. (914mm) AFF. The higher number may be used for biosecurity inspection areas.
5. Lighting controls shall be wall mounted with sealed edges. Lighting controls may be locally and/or remotely supervised through the building management system (BMS) or building automation system (BAS).

**D. Security:** Security measures shall be established to prevent access to the facility. Signage shall be displayed to assist with effective management of the facility's security and biosecurity.

1. Even when in a secured area, access to an insectary requires additional access restrictions. The use of additional access control such as card readers should be considered.
2. In areas where dangerous pathogens and infectious vectors are present, a second layer of access is necessary to limit access to only authorized and experience personnel.
3. The use of video surveillance may be required to monitor the entrance to the insectary or a particular area with additional access restrictions.
4. Alarms should be considered to alert staff when access restrictions are not properly followed.

This may include access to cabinets with restrictions.

5. Card readers, video surveillance, and alarms should be connected to the security system and alarms should notify the proper personnel or authorities.

**References:**

<sup>1</sup> Arthropod Containment Guidelines, Version 3.1. The American Committee of Medical Entomology of the American Society of Tropical Medicine and Hygiene.

<sup>2</sup>Biosafety in Microbiological and Biomedical Laboratories, 5th Edition. U.S. Department of Health and Human Services, Centers for Disease Control and Prevention, and National Institutes of Health.

# Appendix 0.2

## Electron Microscopes and Nanotechnology

---

### Contents

1.1.0 Electron Microscopes

1.1.1 Nanotechnology Equipment

2.1.0 General Design Criteria

3.1.0 Specific Design Criteria

## 1.1.0 Electron Microscopes

Electron microscopes (EMs) use a beam of electrons to illuminate a specimen and produce a magnified image. An EM has greater resolving power than a light-powered optical microscope, and can currently achieve magnifications of up to about 10,000,000X. Transmission electron microscopes (TEM) and scanning electron microscopes (SEM) are high resolution instruments that are extremely sensitive to environmental instabilities such as temperature, vibration, acoustic noise, pressure, and magnetic fields. This sensitivity is due to the long acquisition time required for the image or the need for multiple images. Slight changes in any one of these parameters can cause distortion in the microscopic image. These and other high resolution instruments are also sensitive to very low frequency noise sources.

### 1.1.1 Nanotechnology Equipment

Nanometrology is the measurement of dimensions or tolerances below 1  $\mu\text{m}$ . Nanotechnology is the engineering of functional systems at the molecular scale. The same design principles for electron microscopes hold true for rooms designed for nanotechnology equipment; in some cases, however, the requirements may be more stringent. Since designing a more technically stringent facility will cost more, it is important to discuss the equipment requirements with the end user to determine the limitations of the room, as well as to consider if the room should be designed to accommodate new technologies that might require even more stringent conditions.

*A risk assessment should be performed in order to determine the degree of stringency required.*

## 2.1.0 General Design Criteria

When designing rooms for high resolution equipment, it is important to ensure reliability and repeatability in the experimental results. The goal is to reduce environmental instability to the greatest degree possible in order to achieve optimal instrument performance. It is important to know the sensitivity of the instrument to

be housed in the facility. The room housing a high resolution instrument should be considered an extension of the instrument.

High resolution equipment facilities (for TEMs, SEMs, other EMs, and nanometrology) should meet as many of the following criteria as possible:

- The environmental control system shall have N+1 redundancy on ALL major components to keep the environmental chamber at a constant temperature, pressure, and humidity. The control system shall utilize a full proportional-integral-derivative (PID) controller. The PID controller must be tuned using a numerical method, such as simplified first order plus dead time (FOPDT) process models.
- The facility and equipment should be located far away from roads, parking lots, elevators, and air handling equipment to minimize ground-borne vibrations from automobile and railway traffic, construction equipment, blowers and pumps, etc.
- The facility should be isolated structurally from the main building to the greatest extent possible to mitigate the propagation of transient vibrations.
- Restricted access to the facility, equipment, and infrastructure should be considered during the design.
- Ideally, the facility should be located below ground to facilitate a constant temperature, and be equipped with an adjacent control room that houses much of the electronic instrumentation.
- Air handling should be designed to prevent building air from blowing directly on equipment.
- Carefully regulated temperature and humidity control should be provided.
- Air to spaces containing high resolution equipment should typically be filtered to reduce particle concentrations by roughly a factor of ten below that of air throughout other spaces in the building. This should be verified based on research protocols.
- The facility should be far removed from high-voltage transformers and high-current electrical power lines.
- Independent and quiet electrical grounds should be distributed throughout the lab. Any required 110 V power lines should be filtered, regulated, and distributed by twisted wires to reduce stray magnetic fields.



- The use of discharge lighting and ballasts should be minimized.
- Electromagnetic shielding or a cancelling system to reduce the influence of outside electromagnetic interference (EMI) should be considered.
- The facility should make use of sound-absorbent walls, ceilings, and floors which minimize background acoustic noise and which are appropriate for clean environments.
- Magnetic shielding can be used to provide a low reluctance path for external fields. The shielding has to enclose the instrument on all sides.

### 3.1.0 Specific Design Criteria

**A. Electromagnetic Fields:** Keep electromagnetic fields to less than 0.1 milligauss RMS (root mean square). EMI can cause beam deflections in both the scanning system and the spectrometer.

Listed below are some common sources of electromagnetic fields from inside the room as well as potential means to remediate them:

1. Small pieces of metal moving near the equipment (such as the steel wheels on a chair)
  - a. Consider the use of plastic or all-wood furniture inside the room.
2. Electrical distribution and equipment
  - a. Careful design of power routing and isolation of transformers, electric motors, and background fields will help reduce electromagnetic fields inside the room.
  - b. In a retrofit, overhaul existing wiring and install dedicated supplies for the microscope.
  - c. Route power conduits as far as possible from the microscope column.
  - d. The AC fields (mostly from computer monitors) should be 1 milligauss or less. Shielding for top performance, high resolution spectrometers and microscopes often specify ~0.2 milligauss (20 nT) p-pin x,y and z direction.

- e. Place monitors away from the column.
- f. Consider field cancellation systems at the specimen, gun, and viewing chamber.

Sources of electromagnetic fields from outside the room:

1. Movement of materials or equipment in corridors
2. Elevators or escalators near the equipment room
3. Roads, auto traffic, and railroads
4. Loading docks
5. Machine shops or rooms with cryo-pumps

#### **B. Temperature, Humidity Control, and Airflow**

**Across the Column:** Temperature changes should be kept to less than 0.1°C / hr. (32°F / hr.). Airflow across the column should be kept to less than 0.1 m/s (20 fpm). The airflow across the column may vary depending on the type and sensitivity of the equipment. A risk assessment should be performed, and the airflow rate should be based on the results. A rough estimate of the heat output of a microscope (power supply and electronics rack) is 5 kW.

Following are recommendations for temperature, humidity control, and airflow across the column:

1. Separate (and cool independently of the column and HT) the cooling for power supply and electronics racks.
2. Construct a shelter around the column on three sides to prevent drafts blowing across the column.
3. Wrap the column in bubble wrap or neoprene to dampen thermal fluctuations.
4. A radiant cooling system is recommended and is an inexpensive retrofit when used in conjunction with a forced air A/C system. The forced air is used mainly to control humidity. Radiant cooling can control temperature to better than 0.1°C (32°F) and provides exceptional temperature stability.
5. To retrofit a forced air cooling system:
  - a. Add a reheat coil with feedback from the thermo-coupler near the column to reduce fluctuations.

- b. Place inlets away from the column to avoid unacceptable currents.
- c. Diffuse the airflow by installing a ceiling with an abundant number of small holes across the ceiling surface, but none directly above the column. The holes should be arranged to provide for laminar airflow.
- d. A less expensive solution is to add a duct sock that is tightly sealed to the air inlet. Requirements for this design solution are as follows:
  - i. The cooling cycling must be minimized.
  - ii. Air supply to the instrument room should be minimal to avoid sudden fluctuations in temperature.
  - iii. Temperature fluctuations should be kept to 0.1°C / hr. (32°F / hr.).
  - iv. Temperature probes shall be of the highest accuracy.

**C. Control of Air Pressure Changes:** Keep air pressure changes to less than a few Pascals per minute. Pressure changes can cause blurring or deflection depending on the instrument. Air pressure changes of 1 Pa can result in stage deflection of about 0.1 nm. Barometric pressure changes due to weather or opening an outside door in the building can affect the microscope room pressure. One solution is to design a perfectly airtight clamshell airlock cover with an O-ring seal to isolate the specimen rod from rapid pressure changes in the room. This can reduce pressure fluctuations by a factor of ten.

**D. Vibration Considerations:** In order to reduce vibration to a minimum, sensitive equipment must be supported on an isolated high-mass platform designed to have a resonant frequency far below any internal resonances characteristic of the equipment itself.

Surrounding background vibrational noise, or the “natural frequency” of a facility, should lie well above the resonance frequency of the high-mass platform. Equipment components tend to vibrate in the 100 Hz – 10 kHz range. The high mass platform requires a sufficiently large mass to lower the resonant frequency of the platform into the 1 Hz range.

Vibrations in a floor supporting the microscope may be caused by traffic on roads or rails, nearby machinery, or movement of the building itself. It is recommended that the microscope be on an isolated high-mass concrete slab on bedrock or appropriate engineered fill, with a gap between the concrete slab and the surrounding structure. The gap may be filled with a closed cell neoprene rubber gasket which does not transmit vibrations. The walls should be isolated from the roof and the floor slab.

The vibration criterion (VC) will be based on VC-D with the maximum vibration of 6 micrometers/sec, RMS, as measured in one-third octave bands of frequency over the frequency range 8 to 100 Hz.

**E. Acoustic Noise:** Sound energy can come from automobile traffic, air handlers, blowers, nearby walkways, and human conversation. For airborne noise, the frequency range of interest generally lies between ~20 Hz and ~20 kHz. Current high-resolution microscopes tend to be side-entry, which allows vibrations to more easily transfer through the holder to the specimen. A typical installation includes equipment such as the energy filter and X-ray detector, and the associated computers which are sources of noise within the room. It is recommended that most high resolution equipment facilities achieve a minimum of an NC-35 rating.

Recommendations to reduce the entrance of noise and to dampen noise in the room include:

1. Remove noisy microscope equipment (pumps, power racks, compressor) to another room or into a purpose-built back room.
2. Construct acoustically “dead” walls, which may be achieved through the use of curtains or cloth-covered, sound-absorbent fiberglass tiles with a sound absorption factor of 1.15.

**F. Room Layout and Architectural Features:** High resolution instrument room layout will vary depending on the type and sensitivity of equipment specified and site constraints.

The electron microscope suite should at a minimum follow the below criteria and considerations:

1. Provide a separate room for heat, vibration, or noise generating equipment associated with the electron microscope or nano-equipment.

2. The suite should be placed on a vibration isolated slab on grade.
  3. The suite should include a sample preparation area (off the block).
  4. The suite should include appropriate shielding.
  5. Any window within the suite should be comprised of a pair of double pane windows in series for better sound isolation.
  6. The suite should be physically separated from busy corridors or other sound and vibration generating areas.
  7. Provisions should be made for an adequate number of regular power sockets, in addition to the special outlets for the microscope, chiller, etc., inside the room and in the room holding the ancillary equipment. Fourteen to sixteen sockets between the scope room and the accessory room is an average number.
2. Sealing all seams on the interior wall of the laboratory using ironed-on copper foil or copper mesh foil (or both) placed underneath screwed-on sealing strips. The shielding has to surround the entire laboratory, including the pit area supporting the concrete slab and the ceiling, which houses air ducts and lighting fixtures.
  3. Using a sealed double door (outside door to maintain temperature stability, inside door to provide EM shielding) at the entrance to the laboratory from the control room. A tightly latched inner steel door should be equipped with reentrant leaf-spring seals located around the door's entire perimeter.
  4. Using air locks to avoid sudden pressure changes.

Other systems that must be considered in the room design include:

1. Cooling water (in and return)
2. House vacuum
3. Dry N<sub>2</sub> gas
4. Fire alarms
5. Fire sprinklers
6. Emergency lights
7. Oxygen sensor
8. Telephone
9. Internet
10. SL and NL power
11. Instrument (ground) shielding

Depending on the requirements of the microscope and building conditions, EMI may have to be mitigated with an EM canceling system or shielding. Important things to consider in the design of an EM cancelling system are:

1. Small channels formed in the floor to carry the conduits for the field cancellation X and Y cables that then pass up the walls and inside the false ceiling. The Z loop passes around the perimeter of the false ceiling at a height of around 4m above the floor.
2. Channels in the concrete slab and floor can also be provided for the cables and plumbing that pass between the microscope and back room.

For EM shielding, design features may include:

1. Covering the entire laboratory room with two panels of steel plate on either side of a plywood sheet.

# Revisions

No.	Location	Revision Description	Date Complete	DRM Revision #
1	Section 7.4	Remove Section 7.4.12.	04/17/2017	0.1
2	Multiple	Change all references of National Electric Code to National Electrical Code.	04/17/2017	0.1
3	Section 5.2	Typo within Table 5.2.1(A). 105 lb/sf should be 150 lb/sf.	04/17/2017	0.1
4	Appendix E	Added "Coordination, Constructability, Phasing, and Maintainability" to Appendix E.	04/17/2017	0.1
5	Appendix J	Corrected stud specification for lab & office from 20 & 25 to 18 & 22.	04/17/2017	0.1
6	Section 7.6	Corrected numbering in 7.6.3.	04/17/2017	0.1
7	Section 7.4	Adjusted 7.4.2-I to require freeze-stat with manual reset versus automatic.	04/17/2017	0.1
8	Section 7.3	Changed requirement from Carbon Dioxide detector to Carbon Monoxide detector in 7.3.12.	04/17/2017	0.1
9	Section 4.5	Removed section 4.5.1.2-C regarding lab shelving tight to walls.	04/17/2017	0.1
10	Section 11.1	Removed Exhibit 11.1 and references and added new section (also see revision 11).	04/17/2017	0.1
11	Section 9.4	Added new section 9.4.8 for In-Building Signal Amplification.	04/17/2017	0.1
12	Section 1.15	Added "K. Abandoned Infrastructure" to 1.15.1.	04/17/2017	0.1
13	Acknowledgements	Corrected credentials for committee members and reviewers.	8/16/17	0.2
14	Multiple	Corrected misspellings of "fire marshal".	8/17/17	0.2
15	Section 1.11	Adjusted title under 1.11.3.4 K to Hazardous & Radioactive storage.	8/18/17	0.2
16	2.1	Added placement information regarding acid cabinets & flammable storage cabinets to 2.1.3.7.3	8/18/17	0.2
17	4.2	Added requirement for vision panels with hinged covers in light restricted labs.	8/18/17	0.2
18	4.3	Added NIC requirements for partitions between enclosed rooms & non-public corridors.	8/17/17	0.2
19	4.4	Adjusted NRC requirement for acoustic ceiling tile to 0.70.	8/17/17	0.2
20	4.4	Adjusted wording from non-absorptive to hydrophobic ceiling tile and increased NRC to 0.80.	8/17/17	0.2
21	4.5	Changed requirement for Flammable Storage Cabinets to be required in every lab.	8/17/17	0.2
22	Appendix I	Removed extraneous "N" heading.	8/17/17	0.2
23	Appendix I	Added "NIC" acronym.	8/17/17	0.2

No.	Location	Revision Description	Date Complete	DRM Revision #
24	6.3	General Note Q in Exhibit 6.3, clarified double containment to be heat-fusion type and that system rating is at least 5 PSI.	8/18/17	0.2
25	6.3	Added "ASME BPE Type" to clarify the weld requirements for application Note #12 in Exhibit 6.3.	8/18/17	0.2
26	6.3	In Exhibit 6.3 pipe type RR, added provisions to permit Schedule 10S piping to be utilized.	8/18/17	0.2
27	6.3	In Exhibit 6.3 joint type L, added BCuP-9 or BAg-5 alloy requirement for brazing of threaded adapters.	8/18/17	0.2
28	6.3	In Exhibit 6.3 joint type bb, added BCuP-9 or BAg-5 alloy requirement for brazing of threaded adapters.	8/18/17	0.2
29	6.3	In Exhibit 6.3 joint type ff, added BCuP-9 or BAg-5 alloy requirement for brazing of threaded adapters.	8/18/17	0.2
30	6.3	Added "ASME BPE Type" to clarify the weld requirements associated with Joint Type nn in Exhibit 6.3.	8/18/17	0.2
31	8.1	Added maximum RPM, motor and VFD requirements for electric motors.	8/18/17	0.2
32	8.1	Added design piping flexibility temperature ranges and provisions for double braiding reinforcement of flexible hoses.	8/18/17	0.2
33	8.2	Corrected minimum trapway ball pass dimensions to 70mm and 2-3/4".	8/18/17	0.2
34	8.2	Provided clarification regarding allowable lab sink materials.	8/29/17	0.2
35	8.3	Corrected paragraph name to reflect contents and clarified the point in the system and provisions whereby treatment devices that remove residual disinfectant may be located.	8/18/17	0.2
36	8.3	Added provisions for fixture thermostatic mixing placement and limitations of group fixture common local thermostatic control.	8/18/17	0.2
37	8.3	Addressed requirements for electric-actuated mixing valves, stagnancy/dead leg prevention, and hot and cold water system pressure balance.	8/18/17	0.2
38	8.3	Addressed items associated with an exemption from N+1 redundancy of master mixing valves and requires consideration of relative system pressure balance conditions in selecting POU temperature control valves.	8/18/17	0.2



No.	Location	Revision Description	Date Complete	DRM Revision #
39	8.3	Clarified over-temperature control requirements and that redundancy of such booster heaters is not required.	8/18/17	0.2
40	12.1	Addressed provisions of TOC monitor locations and use of shared analyzer.	8/18/17	0.2
41	12.1	Clarified membrane contactor usage is also present for control of algae, pH, and conductivity.	8/18/17	0.2
42	12.1	Clarified pump redundancy is required.	8/18/17	0.2
43	12.1	Addressed required distribution loop and valving arrangements for cases where serpentine distribution is utilized.	8/18/17	0.2
44	12.1	Clarified water quality requirements used in HPW systems for flushing and testing.	8/18/17	0.2
45	12.2	Clarified test requirements for source water to include consideration of radionuclides.	8/18/17	0.2
46	12.2	Rationale clarification to remove specificity of chlorine and address radionuclides.	8/18/17	0.2
47	12.2	Clarified notification requirements and alert process so filters are not unnecessarily applied or without consideration of maintenance requirements unique to this application.	8/18/17	0.2
48	12.2	Revised filter design loading/replacement frequency and notification requirements where utilized to 30-60 days.	8/18/17	0.2
49	12.3	Added the words "CO <sub>2</sub> System" before testing.	8/18/17	0.2
50	12.3	Clarified brazing requirements with regards to threaded connections to prevent annealing induced failures	8/18/17	0.2
51	12.3	Renamed subsection and subparts to also include/address Argon.	8/18/17	0.2
52	12.3	Addressed provisions for system materials for various inert moderate to high purity gas applications and references associated provisions of the DRM.	8/18/17	0.2
53	12.3	Corrected typo "specific" to read "related".	8/18/17	0.2
54	12.5	Clarified alarm sensor issues associated with sensitivity to avoid false alarms.	8/18/17	0.2
55	12.5	Clarified high vacuum level by deleting "180" and "135".	8/18/17	0.2
56	12.5	Delete "180 to" to clarify vacuum level.	8/18/17	0.2
57	Appendix A	Added placement of BSC in "typical" module with in-swing door.	8/22/17	0.2

No.	Location	Revision Description	Date Complete	DRM Revision #
58	Appendix L	Corrected BSL-3 / ABSL-3 Electrical Sealant for joints between ceiling and light fixtures from JS-4 to JS-3.	12/14/2017	1.0
59	1.5	Removed UEB from NIH Technical Review Staff as they are under DTR.	12/14/2017	1.0
60	3.5	Added requirement for deer protection for trees.	12/14/2017	1.0
61	6.1	Removed "Pharmacy Compounding Facility" and "Human Cellular and Gene Therapy Processing Facility" text. Inserted link to Chapter 13.	1/11/2018	1.0
62	Multiple	Removed or modified references to "Contracting Officer Technical Representative" and changed to PO.	1/11/2018	1.0
63	Multiple	Adjusted all instances of "clean room" to "cleanroom".	1/11/2018	1.0
64	1.3	Added Aseptic Production Definitions to General Definitions Section.	1/11/2018	1.0
65	8.3	Clarified requirements that circulating emergency fixture water back to a heater is unacceptable.	1/11/2018	1.0
66	Exhibit 6.3	Clarified acceptable reference standards for hubless couplings.	1/11/2018	1.0
67	Exhibit 6.3	Added minimum criteria for flanged joints.	1/11/2018	1.0
68	8.3	Updated language to reflect water heater temperature controller temperature accuracy/ stability requirements.	1/17/2018	1.0
69	8.3	Clarified sampling and flushing requirements associated with water systems disinfection.	1/17/2018	1.0
70	11.2	Corrected typo of floor loading requirement from "150 psi" to "psf".	1/17/2018	1.0
71	6.3	Corrected typo of steam instrumentation sensors from "2 ft" to "20 ft".	1/23/2018	1.0
72	1.2	Adjusted referenced codes and standards for Telecom.	1/23/2018	1.0
73	11.3	Adjusted referenced standard to most current.	1/23/2018	1.0
74	12.3	Removed information under Pharmaceutical / Clean Air and referenced to Chapter 13.	1/23/2018	1.0
75	Exhibit 6.3	Added alternative acceptable material requirements for pipe fittings.	1/23/2018	1.0
76	13	Added Chapter 13 on Aseptic Production Facilities.	1/25/2018	1.0
77	Exhibit 6.3	Removed in line item 2.a pipe type E, fitting type V and pipe joint g and h.	1/30/2018	1.0
78	Exhibit 6.3	Removed in line item 3.a pipe type E, fitting type V and pipe joint g and h.	1/30/2018	1.0

No.	Location	Revision Description	Date Complete	DRM Revision #
79	Exhibit 6.3	Removed in line item 3.d pipe type E, fitting type V and pipe joint g and h.	1/30/2018	1.0
80	Exhibit 6.3	Removed piping Material-Type Designation E as High Silicon Cast Iron piping is no longer available in the United States.	1/30/2018	1.0
81	Exhibit 6.3	Fitting type Designation V: Removed fitting type and specifications.	1/30/2018	1.0
82	Exhibit 6.3	Removed Pipe Fitting Type XXXIII and Pipe Joint Type ee from Pipe Service Chilled Water Supply and Return, Above Ground Applications (12 c).	8/23/2018	1.1
83	Exhibit 6.3	Removed Pipe Fitting Type XXXIII and Pipe Joint Type ee from Pipe Service Condenser Water Supply & Return, Above Ground Applications (14 d).	8/23/2018	1.1
84	Exhibit 6.3	Removed Pipe Material II Pipe Fitting Type XXXIII and Pipe Joint Type ee from Pipe Service Cooling Water Supply & Return, Above Ground Applications (15 b).	8/23/2018	1.1
85	Exhibit 6.3	Changed “chilled pressurized” to “process” in Keyed Note 13.	8/23/2018	1.1
86	Exhibit 6.3	Removed Fitting Type XXXIII from Pipe Fitting Specifications.	8/23/2018	1.1
87	Exhibit 6.3	Removed Joint Type Designation “ee”.	8/23/2018	1.1
88	1.2	Added FGI to Referenced Codes & Standards.	8/23/2018	1.1
89	4.4	Added additional language regarding laboratory finishes being non-porous.	8/30/2018	1.1
90	4.4	Removed 4.4.3.5 Access Panels.	8/30/2018	1.1
91	4.4	Removed 4.4.3.6 Chairs.	8/30/2018	1.1
92	Appendix L	Corrected sealant between penetrations at top and bottom of slab to “N/S” from “JS-6”.	8/30/2018	1.1
93	13.7	Removed items 3 and 4 within 13.17.10 as they were repeats of items 2(a) and 2(b).	8/30/2018	1.1
94	1.6	Removed language about review and approval of final cost of Government Estimate.	8/30/2018	1.1
95	Exhibit 6.3	Corrected type within Material-Type Designation “Q”. Text should have stated “Type L Hard drawn; except where copper is not allowed”.	9/7/2018	1.1
96	6.1	Added language for quench pipe failure analysis.	9/7/2018	1.1
97	Exhibit 6.1	Inserted new Helium Quench Pipe Failure Room Pressure Analysis Methodology.	9/7/2018	1.1
98	1.5	Added language for variance requests clarifying each request is project & location specific.	9/13/2018	1.1

No.	Location	Revision Description	Date Complete	DRM Revision #
99	Appendix O	Added new appendices for Specialty Labs.	11/26/2018	1.2
100	Multiple	Corrected reference from Architectural Barriers Act (ABA) to Architectural Barriers Act Accessibility Standard (ABAAS).	11/26/2018	1.2
101	7.5	Corrected conversion typo for chilled beam water temperature.	1/2/2018	1.2
102	8.3	Added language to clarify that monitoring systems and areas served for microbial control shall be approved by ORF & DOHS and may vary by disinfectant.	1/2/2018	1.2
103	12.1	Clarified language for minimum design quality parameters and monitoring for high purity feedwater service.	1/2/2018	1.2
104	3.5	Section completely rewritten by Brandon Hartz with new exhibits.	3/20/2019	1.3
105	13.6	Changes intended to reduce the risk of product contamination.	4/24/2019	1.4
106	13.8	Changes intended to reduce the risk of product contamination.	4/24/2019	1.4
107	Appendix M	Content revision of signage manual.	12/16/2019	1.5
108	5.1	Language revision to progressive collapse and minor content movement, insertion of new 5.1.4: Blast Resistance Design.	12/23/2019	1.5
109	6.1	Added specific guidelines to ventilated corrosive storage cabinet language and requirements.	1/3/2020	1.5
110	Multiple	FDA-recommended clerical errors.	3/5/2020	1.5
111	Multiple Chapters	Chapters 3, 5, and 9 have undergone a full review and been updated based on the results of that review. Removed references to an obsolete document on NIH BSL-3 laboratory certification requirements from sections 1.14.1, 4.9.11, and 6.6.18.	3/8/2024	2.0