

SECTION II: TABLE OF CONTENTS

2. ANIMAL ROOM VARIATIONS	II - 1
2.1 Outline of CFD Baseline Model	II - 1
2.2 Whole Room Configurations	II - 9
2.3 How the Data are Presented	II - 29
2.3.1 Visualizing the Flow – A Qualitative Approach	II - 29
2.3.1.1 Using planar slices through the model	II - 29
2.3.1.2 Using three-dimensional flow visualization.....	II - 31
2.3.2 Quantitative Analysis	II - 32
2.3.3 Analysis of the Results for the Baseline Room	II - 34

2. ANIMAL ROOM VARIATIONS

2.1 Outline of CFD Baseline Model

A typical Animal Research Facility in terms of overall size, air change rate, rack layout, mouse population, pressurization, and other characteristics was modeled as the baseline model for the CFD simulations. The general features of the room are shown in figure 2.01 and listed below.

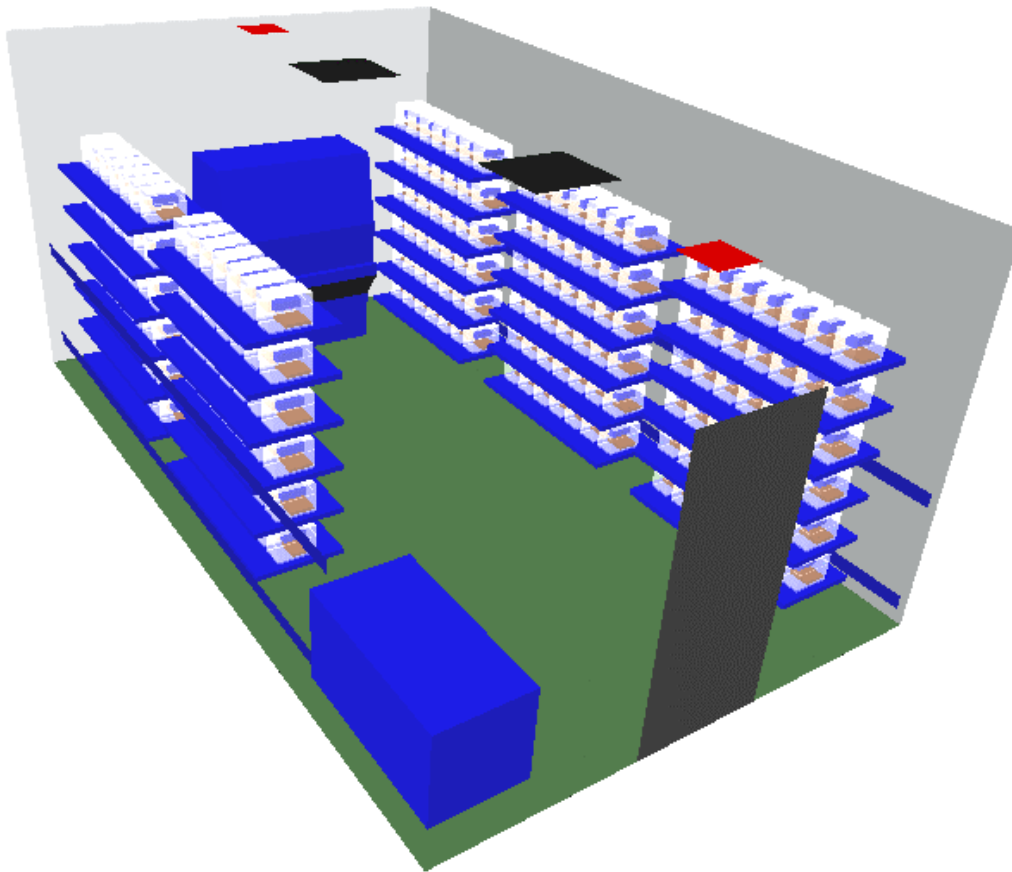

Figure 2.01 Overall layout of Animal Room Basecase

Description in brief

The general features of the basecase room model were:

Room: 6.10m x 3.60m x 4.22m (20' 0" x 12' 0" x 9' 0")
Door on short wall
Sink in corner

Laminar flow change station

5 racks

Cages: Microisolator (with filter top) mouse cage
5 mice per cage

Rack: Static system
6 shelves per rack
7 cages per shelf (42 cages per rack)

Supply: 2 radial supplies each providing 270cfm ($0.13\text{m}^3/\text{s}$) for a total of 15 ACH
Supply discharge temperature, $18.8\text{ }^\circ\text{C}$ ($66\text{ }^\circ\text{F}$), set such that the exhaust air temperature was $22.2\text{ }^\circ\text{C}$ ($72.0\text{ }^\circ\text{F}$)
61 percent relative humidity (to provide 50 percent RH at $22.2\text{ }^\circ\text{C}$ ($72.0\text{ }^\circ\text{F}$))

Exhausts: 2 ceiling level exhausts removing 220 cfm ($0.1\text{m}^3/\text{s}$) each

Makeup Air: 100cfm ($0.047\text{m}^3/\text{s}$) coming from around the door

Overall Geometry

In the majority of the cases considered, the animal room occupied a floor area of 6.10m (20' 0") x 3.66m (12' 0"). In some cases considered, the width of the room was increased from 3.66m to 4.22m (14' 0"). The ceiling height in all cases was 2.74m (9' 0"). There was only one door in the room, which was in the center of one of the short walls.

In all the displacement ventilation systems considered in this project, air was introduced through ceiling mounted diffusers. All devices were mounted flush with the ceiling surface; there was no ductwork present within the upper room volume. The various diffuser types considered in this project were all modeled using a combination of several boundary conditions, which were validated previously (see section 4.2.2). All the air exited through general exhausts. The number and locations of the exhausts were varied. In line with common practice, there was an imbalance between the amount of air supplied to the room and the amount exhausted from the room. This leads to an overall pressurization of the room relative to the rooms or corridors surrounding the room. The relative level of pressurization was a parameter considered in this study. The makeup air to compensate for the supply/exhaust imbalance was allowed to enter or leave the room through 6.35e-3m (0.25") gaps on three sides of the door.

The rooms considered in this project all contained five animal cage racks. The rooms also contained one of two alternative design change stations. A fuller description of these items is given below. The only other item within the room was a sink of dimension 0.61m (24") x 0.61m (24") x 0.81m (32") located in one of the corners of the room.

In all cases, the room was considered under dark period conditions, i.e., the lights were off and produced no additional heat load. Dark period conditions were chosen because early experimental work indicated that heat, CO₂, and NH₃ generations were higher in the dark period compared with the lights-on period. Figure 2.02 shows the variation in NH₃ generation over a 10-day period. For CO₂ the generation in the light period was 0.68 g/hr/100g BW compared to 0.91 g/hr/100g BW for the dark period.

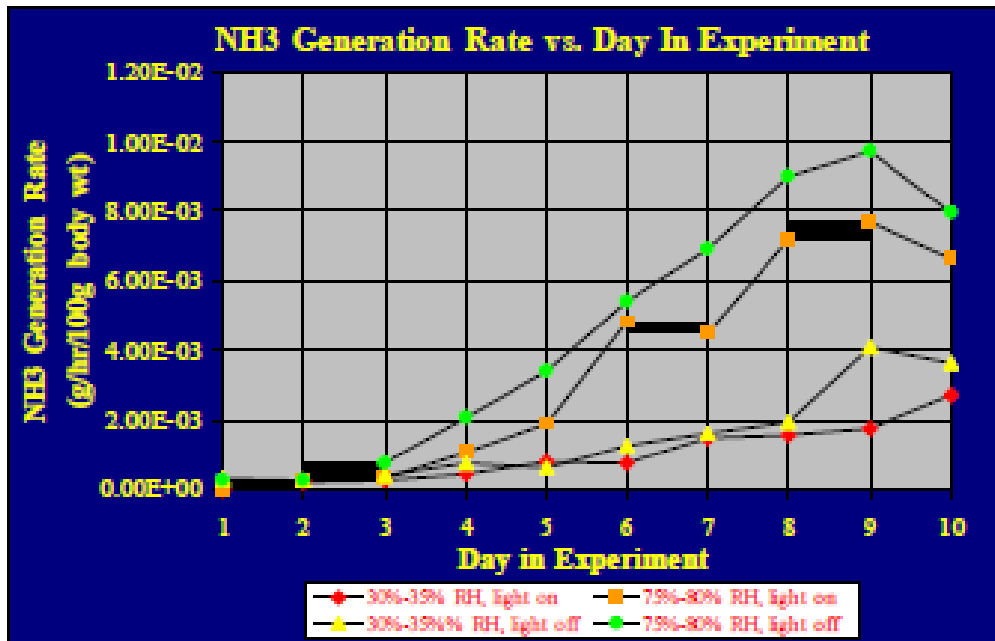

Figure 2.02 Effect of Photoperiod on Gaseous Exchange between the Mouse Cage and the Room Environment

Rack Model

The overall dimensions of the rack were 1.52m (60") x 0.61m (24") x 1.83m (72") high, as shown in figure 2.03. There were six shelves in the rack. The spacing of the shelves was 0.32m (12.75") top surface to top surface. The lowest shelf was at a height of 0.21m (8.25") above the floor. The shelves were modeled on thin rectangular blocks. Details such as the connecting ties between the shelves and the rollers on which the racks move, were not modeled, as their effect on the overall flow field and gas concentration distributions was considered insignificant.

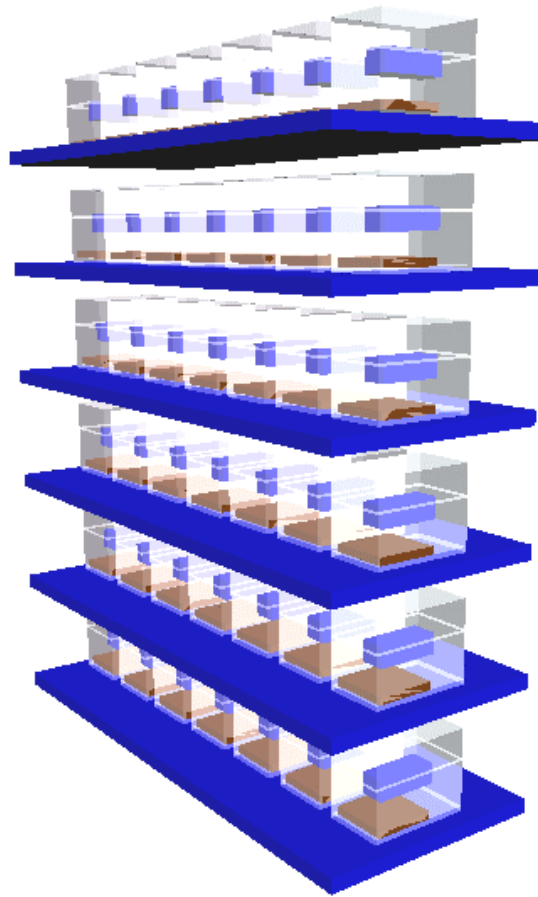

Figure 2.03 *CFD Model of Cage Rack*

Located on the shelves of the racks were representations of the animal cages, shown in figure 2.03. The dimensions of the cage were 0.27m (10.7") x 0.16m (6.38") x 0.21m (8.39") high, which maintained the volume of the original cage that had sloped sides. The sides of the cage were modeled as thin plates, with the thickness and conductivity of the plates set to those of the physical cage polycarbonate. The water bottle and food normally found in a cage were modeled as a single block in order to reduce the computational overhead. The volume of the block was the same as that of the bottle and food combined. The bedding of the cage was included as a rectangular block of dimension 0.27m (10.7") x 0.16m (6.38") x 1.27e-2m (0.5").

The mice were modeled as a block of dimension 0.11m (4.25") x 8.57e-2m (3.38") x 0.22m (0.88"). This was the same representation as was used in the experimental cage wind tunnel tests (see section 4.1.1), and simulated the effect of 'huddling' by the mice. The surface temperature of the block was fixed at 30.0 °C (86.0 °F), which was agreed to be a typical mouse body surface temperature.

Surrounding this block a source of CO₂ was defined at 2.12e-7 kg/s (0.76g/hr), which was based on the generation rate indicated for the dark period in the early tests on the effect of the photoperiod on the mice. This source allowed the additional concentration of CO₂ in the air to be calculated in the simulation. The supply air was assumed to have a zero concentration of CO₂. It also allowed the concentration of other species, such as NH₃, to be calculated by scaling, even though it has a different molecular weight than both air and CO₂. This was possible because the magnitude of the source was very small and the resulting concentrations were so low as to have a negligible effect on the density of the mixture of air, CO₂ and NH₃. In effect, the CO₂ and NH₃ are intimately mixed with and flow with the air.

Experimental data later showed the generation rate of CO₂ was actually higher than the source used in the CFD simulations at 0.90 g/hr/100g mouse body weight. This means the concentration of CO₂ in the room and cages was derived from the simulated concentration multiplied by a scaling factor (0.90/0.76). The concentrations of NH₃ in both the cages and the room were also derived by scaling the concentration with a factor specified in the post-processing of the data. This factor was assumed to vary according to two variables: the number of days that passed since the bedding in the cage was changed and the average relative humidity in the cages (see section 4.2.1.2 for the experimental determination of the factors).

Background levels of CO₂ and NH₃ were assumed to be zero. This means that all values quoted in the CFD section of the report are relative to the background level. If an absolute value for CO₂ is required, an additional amount in the range of 300 ppm to 700 ppm for most locations should be added.

The remaining cage boundary conditions are associated with the transfer mechanisms for air/gases to enter/leave the cage. The cracks at the side of the cage were modeled as 6.35e-3m (0.25”) high planar resistances, with the loss coefficient for these resistances having been determined from the cage wind tunnel CFD simulations (see section 4.2.1.2). The top of the cage, which was filtered, was defined as a combination of a planar resistance and a planar source. The determination of the loss coefficient for the resistance and the coefficient for the source has been outlined (see section 4.2.1.1).

The spacing of the cages on the shelves was dependent on whether the racks were single density (seven cages per shelf), or double density (14 cages per shelf). In the single density cases, the cages were centrally located in the short dimension, and equally spaced in the long dimension. The spacing was 4.88e-2m (1.92”) from corner of cage to corner of adjacent cage. In the double density racks, the cages were equally spaced in both the long and short dimensions. The spacing was 2.20e-2m (0.87”) and 4.88e-2m (1.92”) respectively.

Change Station Model

Two alternative change stations were considered in this project. Both stations were constructed primarily from rectangular blocks and triangular prisms. The internal structure and flow field were of no concern in this project. It was only the effect of the station on the room airflow that is of importance.

The first design is shown in figure 2.04 and is based on a Thoren Maximiser. The station had overall dimensions 1.32m (52") x 0.86m (34") x 1.83m (72"). This design was effectively passive in terms of direct flow field interaction. In particular, the station internally recirculated a flow of 350 cfm ($1.65 \times 10^{-1} \text{ m}^3/\text{s}$) with only 10 percent leakage defined at the sash opening. The makeup air intake for this leakage was mounted at the side of the station. The station dissipated heat that was expected to affect the rooms overall flow field. In particular, the station contributed a load of 720W to the room. This heat was mostly confined to the lower portion of the station where the motor was located.

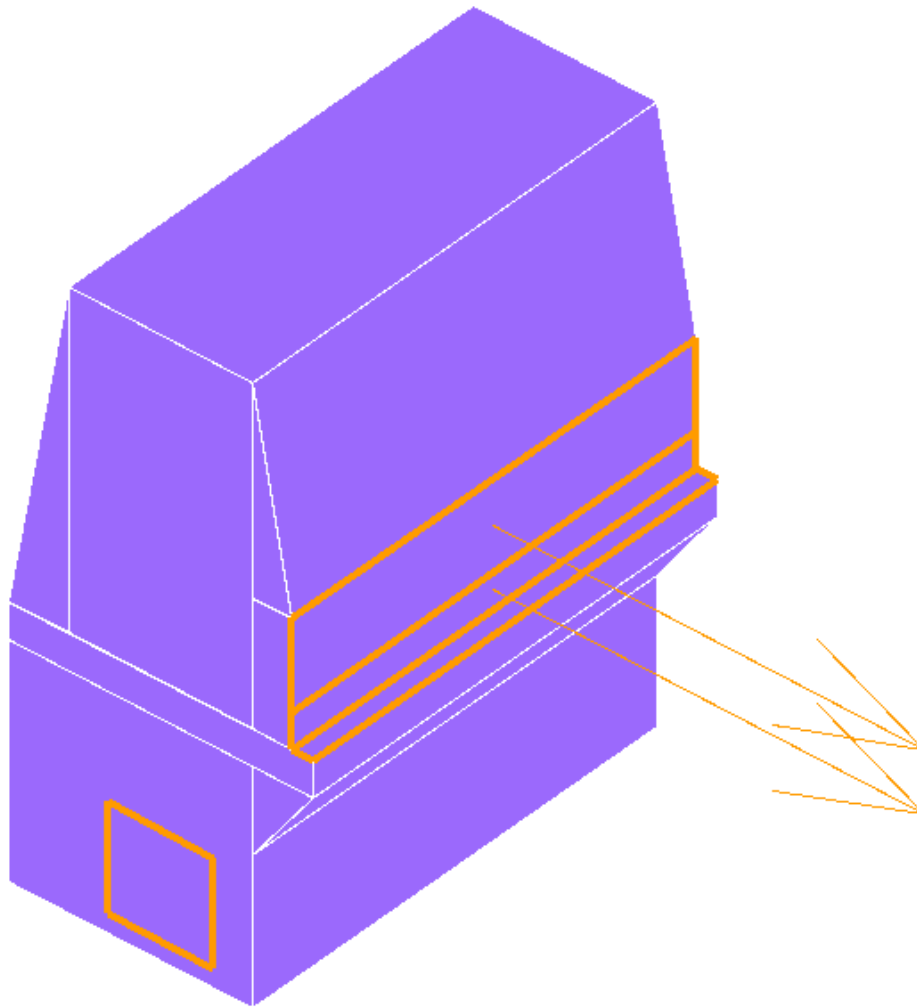

Figure 2.04 Original Change Station Design

Due to concerns raised over the relative passiveness of the first station design, a second design was considered, as displayed in figure 2.05 based on a Laboratory Products Stay-Clean Workbench 30909B. The station had overall dimensions 1.50m (59") x 0.86m (34") x 1.93m (76") high. This station also recirculated air, at 300 cfm ($1.42\text{e-}1 \text{ m}^3/\text{s}$), but discharged a much higher percentage than the first design. In particular, 200 cfm ($9.44\text{e-}2 \text{ m}^3/\text{s}$) was discharged through grilles at the top of the station. The air makeup to compensate for this discharge was mounted at the front sill at the opening to the station. The station dissipated 660W. This heat was considered to be added to the air discharge at the top of the station.

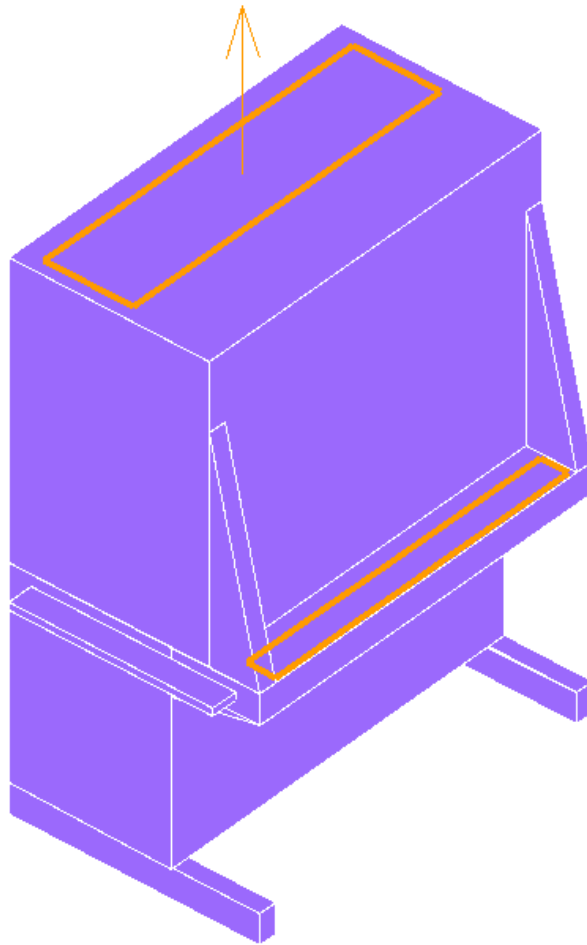

Figure 2.05 *Alternative Change Station Design*

Modeling Assumptions

Solar load was not modeled through the walls of the room.

The floor, ceiling, and walls were assumed to have no heat transfer, i.e., the surrounding areas were assumed to be at the same temperatures.

All surfaces were treated as smooth when calculating surface friction.

The sink in the animal room was modeled as a single rectangular block. The recess formed by the shape of the sink was not modeled because the effect of the recess would be negligible on the overall flow field within the room.

No lighting was assumed in the animal room simulations. The reason for this was that higher CO₂ and NH₃ emissions occur during dark (scotophase) conditions (see figure 2.02, section 4.1.2.8.1 and appendix I: sections 3.4.1.9 and 3.4.1.10).

The animal room was intended to be kept at a nominal 22.2 °C (72.0 °F). For the simulations the temperature control was assumed to be placed in the exhausts, i.e., the exhaust air temperature was set to be 22.2 °C (72.0 °F), and the supply temperatures were set appropriately.

No leakage occurred into or out of the animal room other than that specified through the cracks around the door.

Air density variations due to temperature were negligible. Density variation was therefore ignored in all terms apart from in the momentum term for the vertical velocity component. This is known as the Boussinesq approximation.

The levels of CO₂ and NH₃ were so diluted in the whole room simulations, even at their source, that the variation of the mixture density due to differing molecular weights was negligible.

2.2 Whole Room Configurations

To investigate a range of parameters, the basic model described in section 2.1 was modified. Wherever possible, only one parameter was varied at a time to fully assess the effect.

The list of room runs as they were considered is given in table 2.01. Parameters considered in this report are:

Supply Diffuser Type: Three different diffuser types were considered in this project: radial diffusers; low induction diffusers; and slot diffusers. While all these diffuser types are ceiling mounted diffusers, the flow patterns resulting from them are fundamentally different (see section 4.2.2). See figures 2.06 to 2.08.

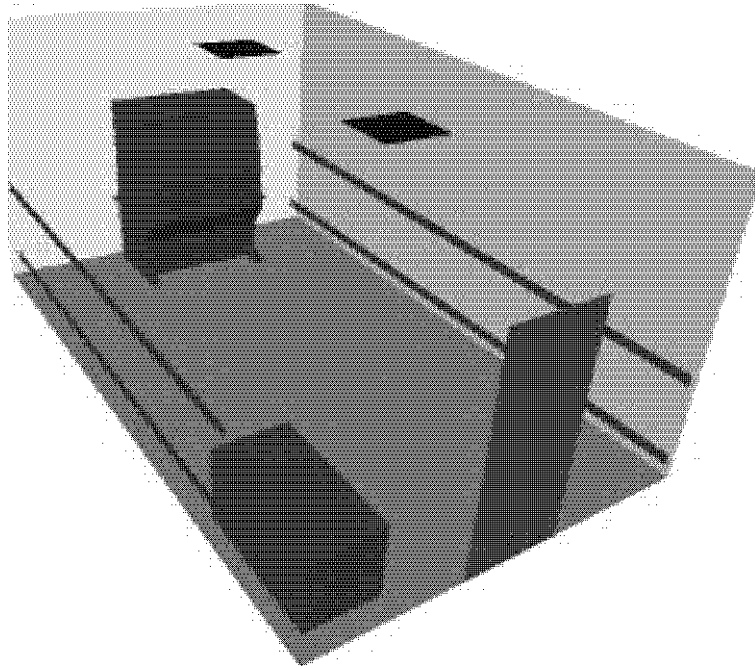

Figure 2.06 Radial Diffuser

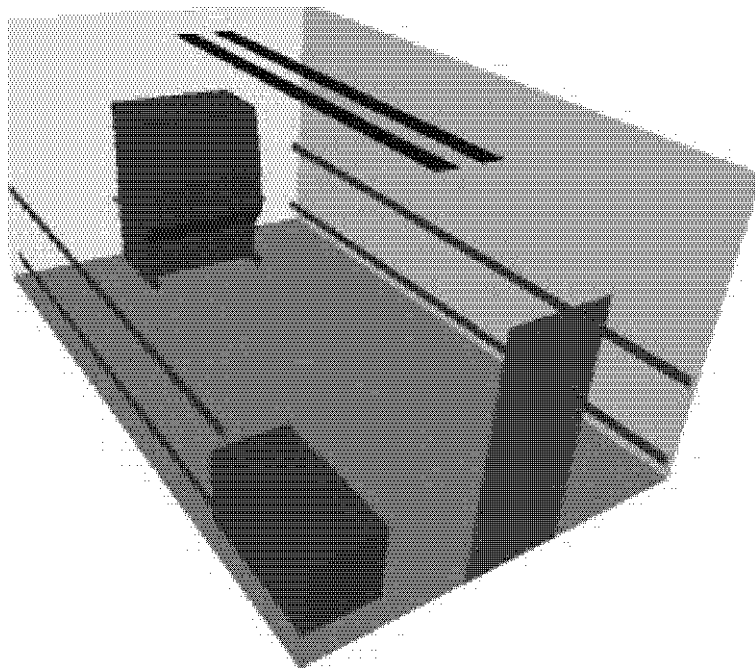

Figure 2.07 Slot Diffuser

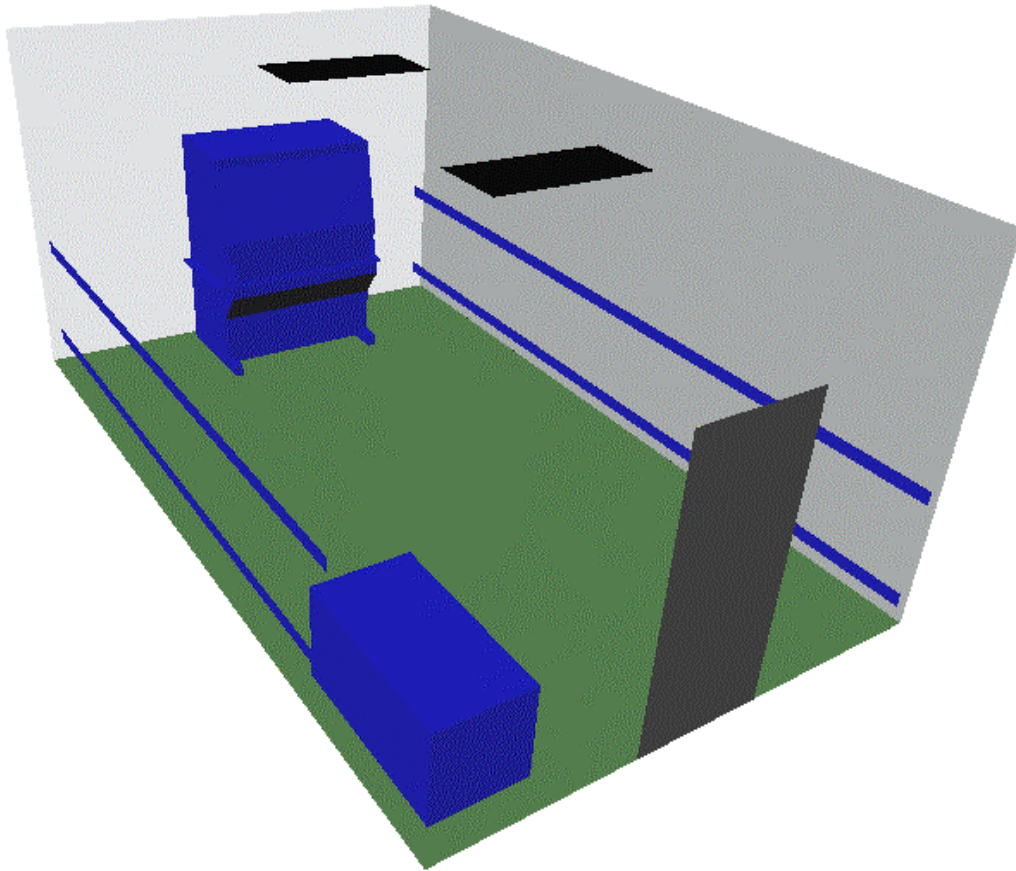

Figure 2.08 *Low Induction Diffuser*

Exhaust Location and Number: Four different exhaust locations were considered, as follows: ceiling, high level, low level on the long walls, and low level on the door wall. The number of exhausts used in each of these locations was also considered as a parameter. See figures 2.09 to 2.12.

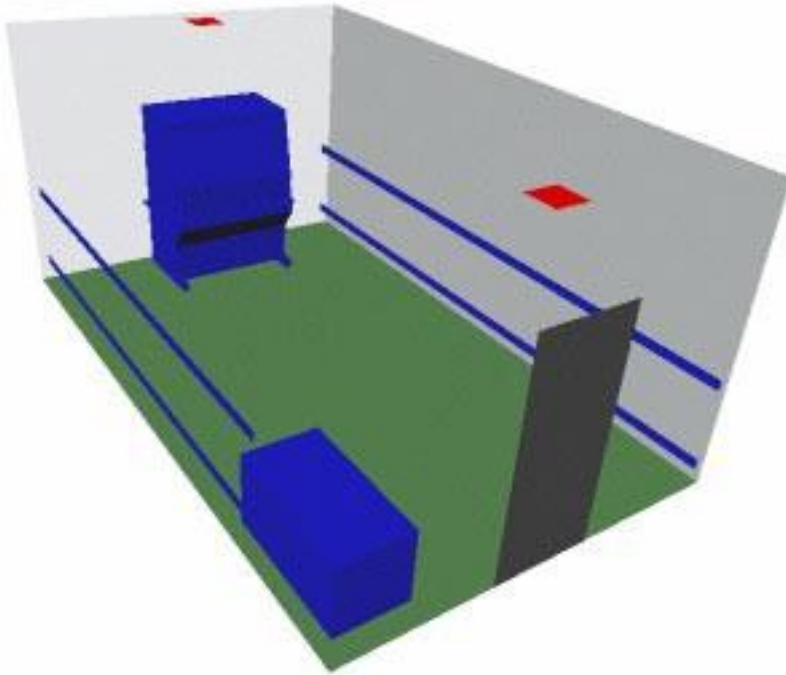

Figure 2.09 Ceiling Level Exhausts

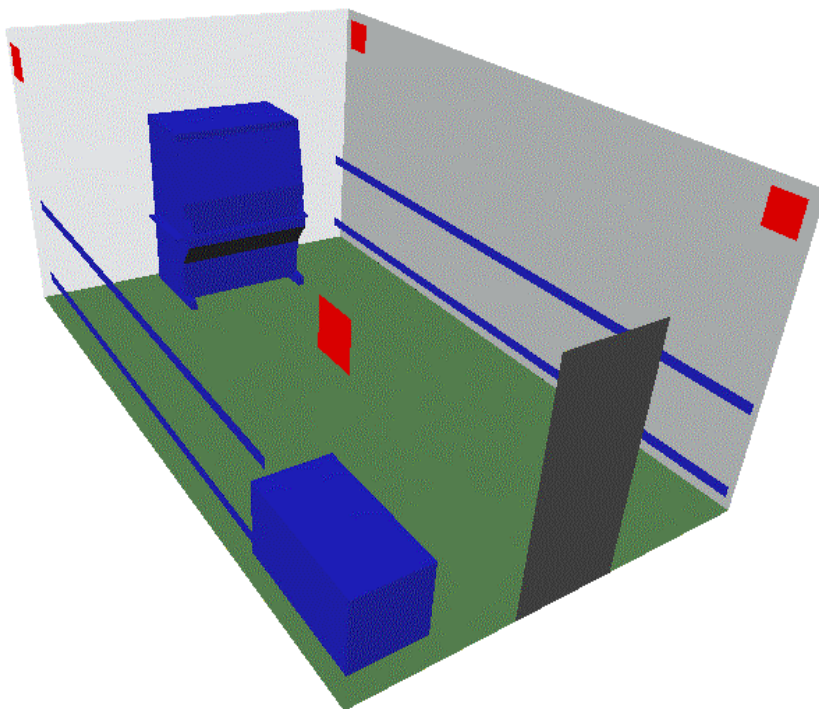

Figure 2.10 High Level Exhausts

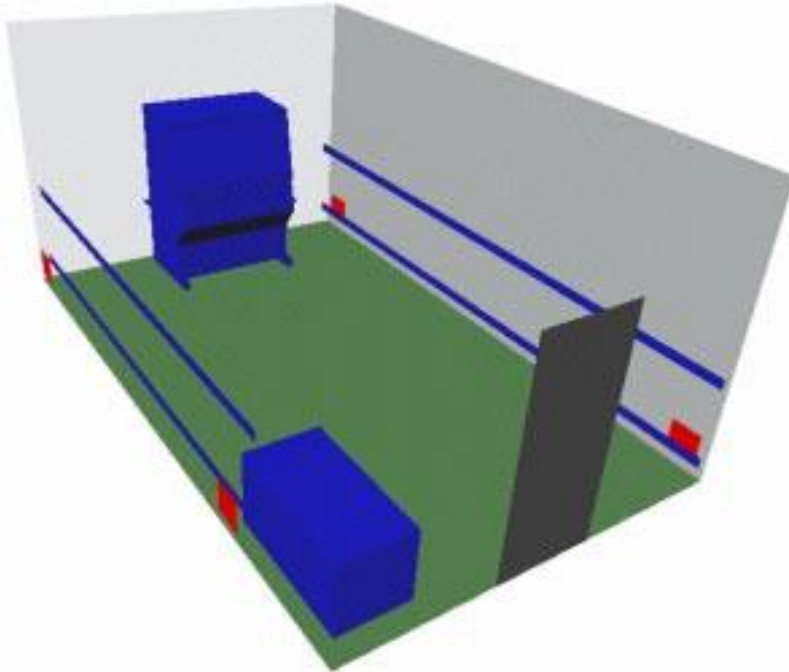

Figure 2.11 Low Level Exhausts

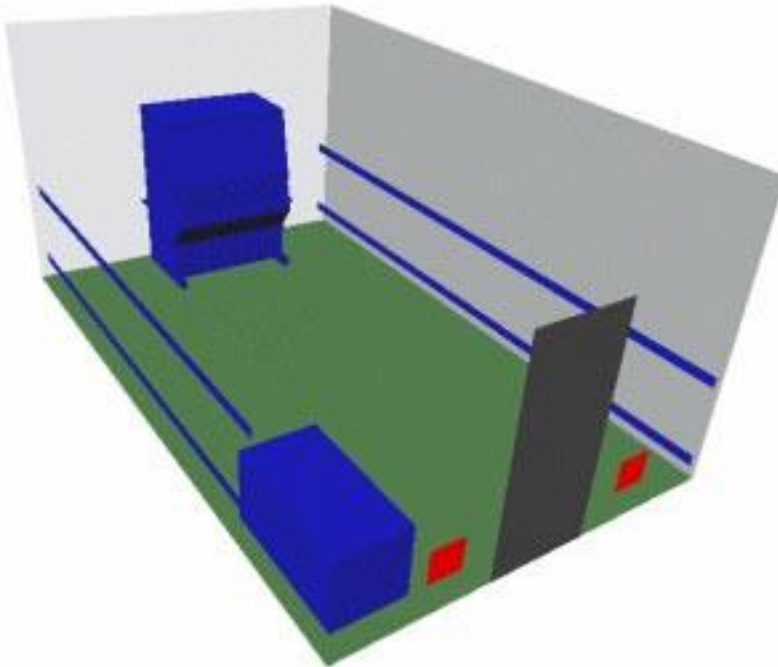

Figure 2.12 Low Level Exhausts on the Door Wall

Room Air Change Rate: In addition to the basecase ACH of 15, three other ACH values were considered: 5, 10 and 20 ACH.

Change Station Design and Status: Two different change station designs were considered, as outlined above. The two designs were intended to present both a passive and intrusive influence to the room volume. In the case of the former design, the station was also considered switched off.

Pressurization of Room Relative to Corridor: The pressurization of a room is dependent on the difference between the supply and exhaust flow rates. A higher exhaust rate than supply leads to negative pressurization of the room, and hence makeup air is supplied to the room via available transfer mechanisms (namely door cracks). In this project, the amount of makeup air allowed through the door cracks was varied between 100 cfm ($4.72\text{e-}1 \text{ m}^3/\text{s}$) into the room to 100 cfm ($4.72\text{e-}1 \text{ m}^3/\text{s}$) out of the room.

Orientation of Cage Racks in Room: The racks were considered both parallel to the long walls and perpendicular to them. See figures 2.13 and 2.14.

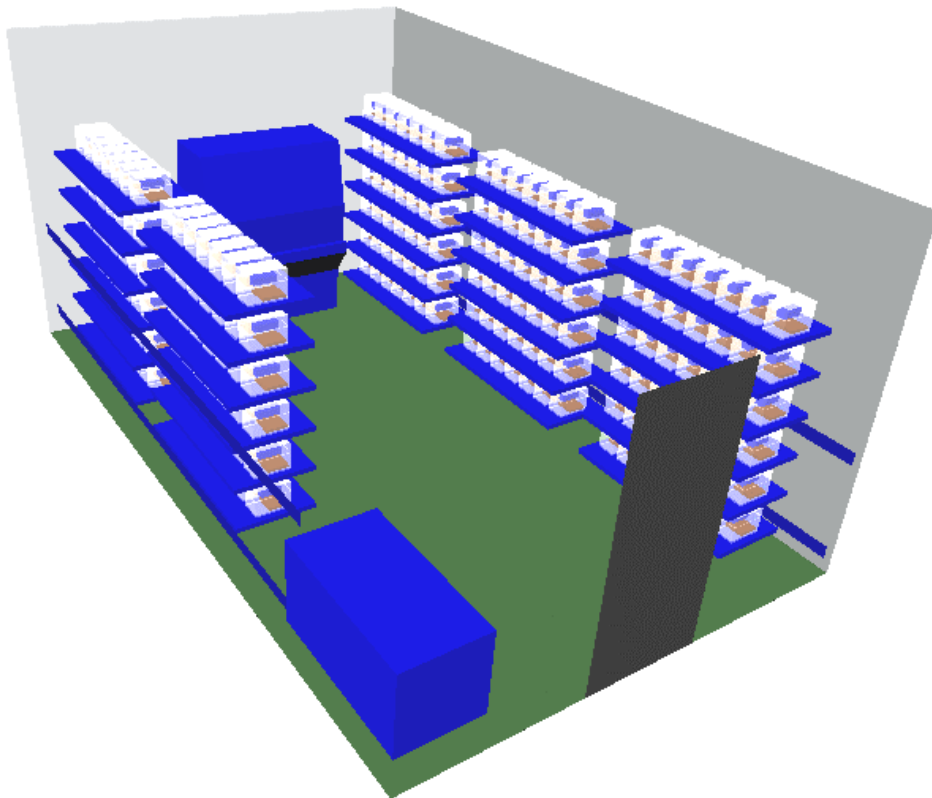

Figure 2.13 Racks Parallel to Side Walls

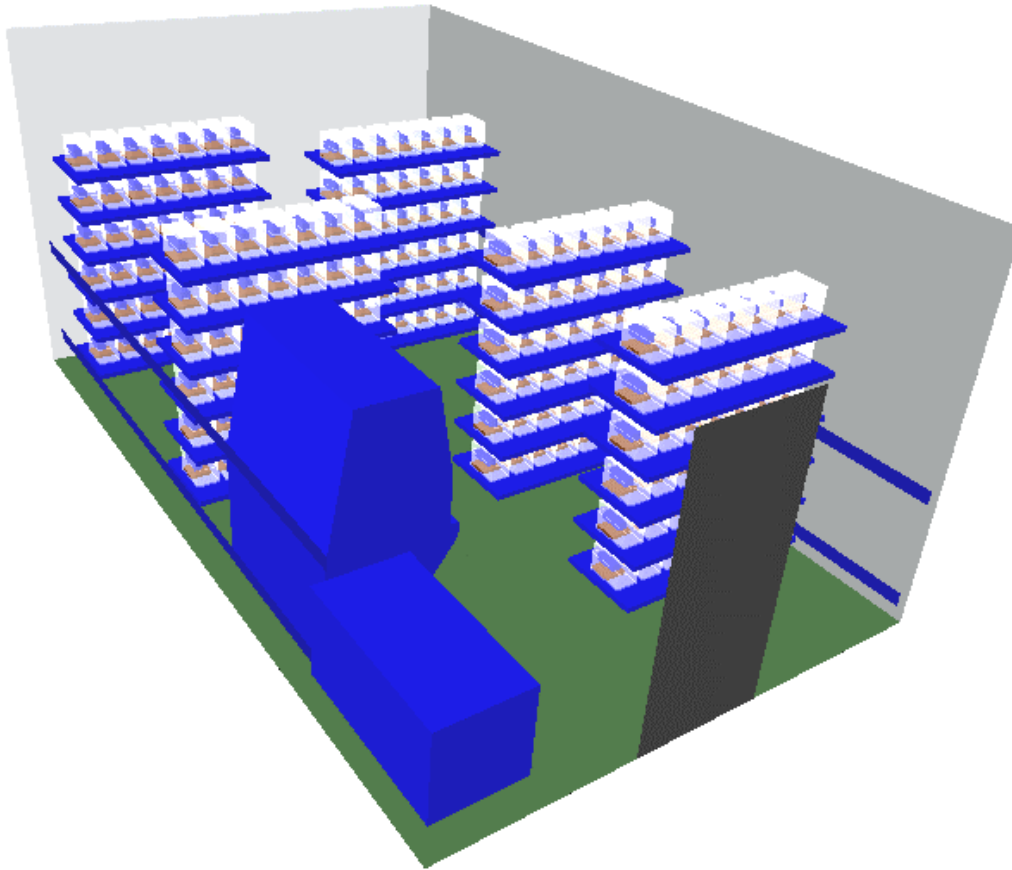

Figure 2.14 Racks Perpendicular to Side Walls

Side Cracks of Cage Sealed Instead of Open: A series of cases was considered in which the side cracks of the cage were sealed, leaving the cage filter top as the only transfer mechanism. The main objective here was to establish the relative increase in cage NH_3 and CO_2 levels when the secondary transfer mechanism is removed.

Density of Cages: The number of cages per rack was considered as a parameter. In addition to the basecase value of 42 cages per rack, a double density rack was considered (84 cages per rack), as was a reduced density rack of 28 cages per rack. See figures 2.15 and 2.16.



Figure 2.15 Double Density Rack

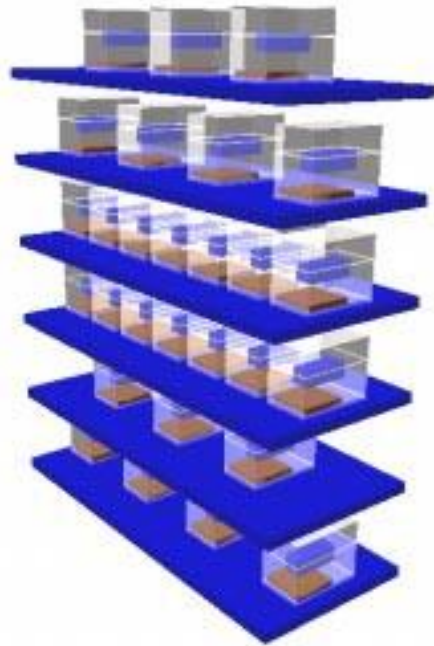

Figure 2.16 Reduced Density Rack

Location of Change Station: The location of the change station was considered swapped with each of the racks in the room. See figures 2.17 to 2.21.

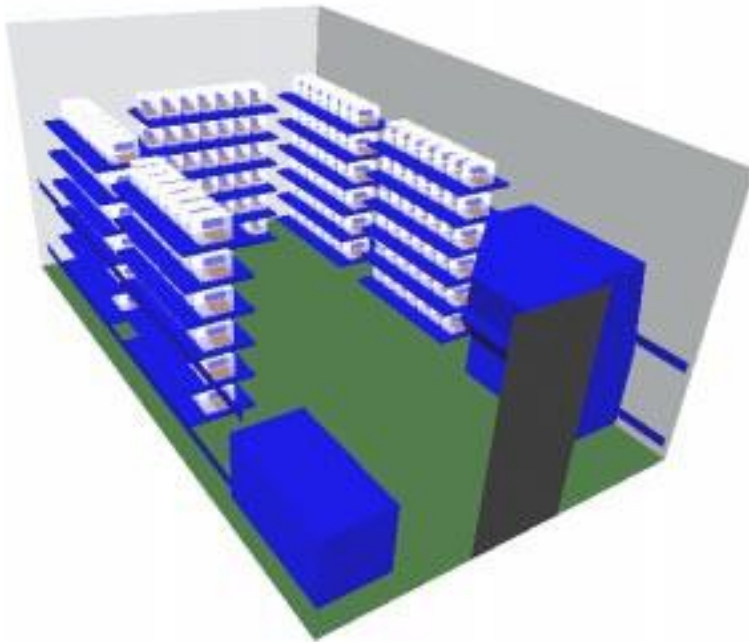

Figure 2.17 *Change Station Swapped with Rack 1*

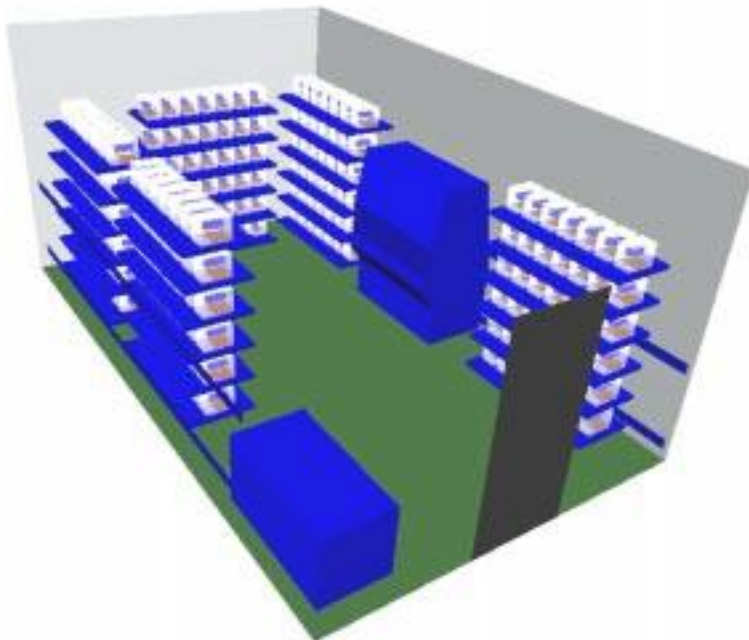

Figure 2.18 *Change Station Swapped with Rack 2*

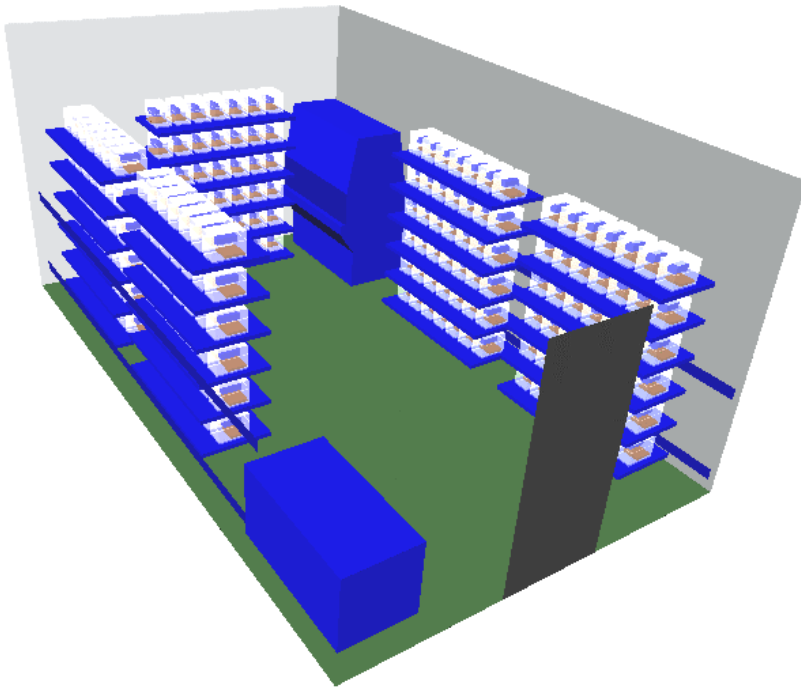

Figure 2.19 Change Station Swapped with Rack 3

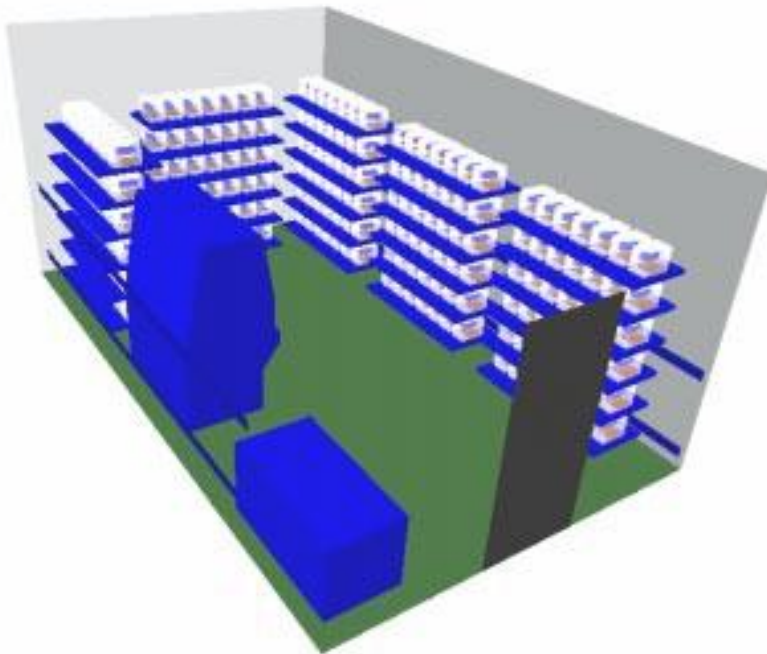

Figure 2.20 Change Station Swapped with Rack 4

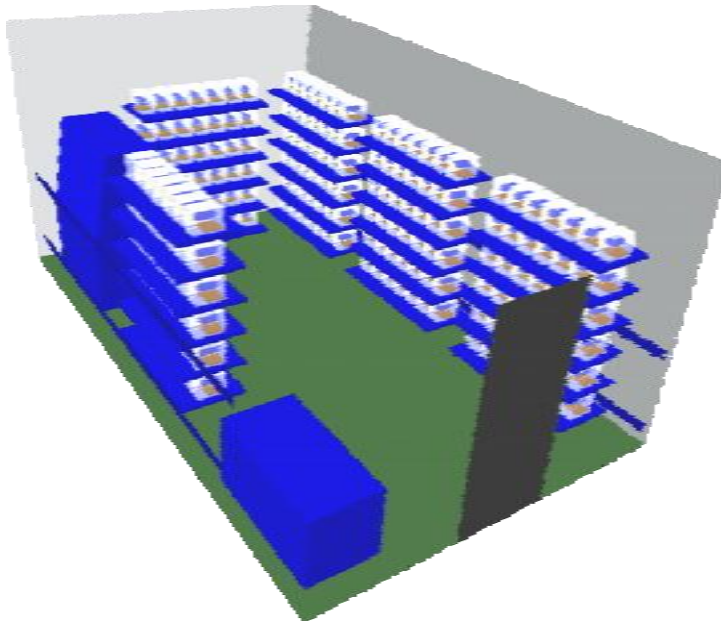

Figure 2.21 *Change Station swapped with Rack 5*

Rack Grouping: In some series, the racks were considered to be along one wall only, rather than spread out through the room. See figure 2.22.

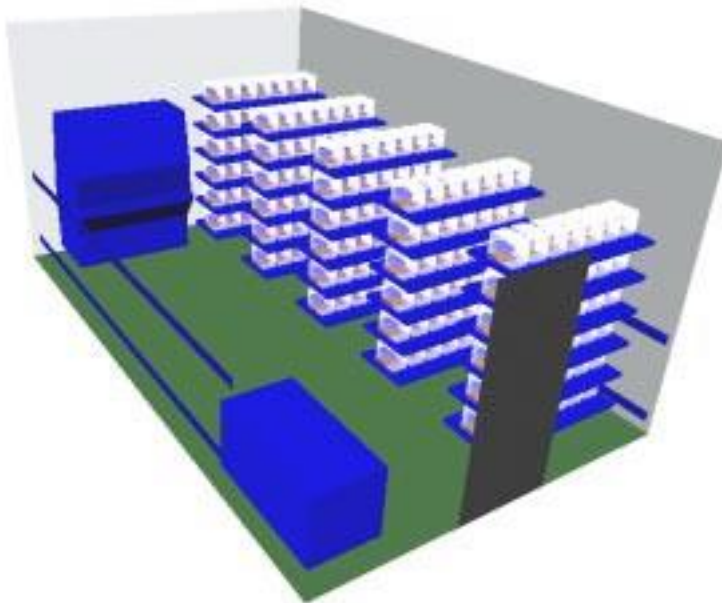

Figure 2.22 *Racks on One Wall Only*

Room Width: Three runs were performed with the room width increased to 4.26m (14' 0").

Supply Air Temperature: In a few runs the supply air temperature was raised to 22.2 °C (72.0 °F) at 49 percent RH, which would cause the room and exhaust temperatures to be about 2 to 3 °C (3.6 to 5.4 °F) higher than the design value of the baseline case.

Table 2.01 List of All Whole Room Runs

Case Name	Supply Diffuser Type	Exhaust Location and Number	Change Station (Design/ Status)	Rack orientation	Rack density	Pressure of Room to Corridor	Supply Temperature °C (°F)	Supply ACH
Basecase	Radial	Ceiling (x2)	Thoren/ ON	Parallel	Single	Neg. 100cfm	18.8 (65.8)	15
Case 02	Radial	High (x4)	Thoren/ ON	Parallel	Single	Neg. 100cfm	18.8 (65.8)	15
Case 03	Radial	Low (x4)	Thoren/ ON	Parallel	Single	Neg. 100cfm	18.8 (65.8)	15
Case 04	Slot	Ceiling (x2)	Thoren/ ON	Parallel	Single	Neg. 100cfm	18.8 (65.8)	15
Case 05	Slot	High (x4)	Thoren/ ON	Parallel	Single	Neg. 100cfm	18.8 (65.8)	15
Case 06	Slot	Low (x4)	Thoren/ ON	Parallel	Single	Neg. 100cfm	18.8 (65.8)	15
Case 07	Low Ind	Ceiling (x2)	Thoren/ ON	Parallel	Single	Neg. 100cfm	18.8 (65.8)	15
Case 08	Low Ind	High (x4)	Thoren/ ON	Parallel	Single	Neg. 100cfm	18.8 (65.8)	15
Case 09	Low Ind	Low (x4)	Thoren/ ON	Parallel	Single	Neg. 100cfm	18.8 (65.8)	15
Case 10	Radial	Ceiling (x2)	Thoren/ OFF	Parallel	Single	Neg. 100cfm	20.7 (69.3)	15
Case 11	Radial	Low (x4)	Thoren/ OFF	Parallel	Single	Neg. 100cfm	20.7 (69.3)	15
Case 12	Slot	Ceiling (x2)	Thoren/ OFF	Parallel	Single	Neg. 100cfm	20.7 (69.3)	15
Case 13	Slot	Low (x4)	Thoren/ OFF	Parallel	Single	Neg. 100cfm	20.7 (69.3)	15
Case 14	Low Ind	Ceiling (x2)	Thoren/ OFF	Parallel	Single	Neg. 100cfm	20.7 (69.3)	15
Case 15	Low Ind	Low (x4)	Thoren/ OFF	Parallel	Single	Neg. 100cfm	20.7 (69.3)	15
Case 16	Radial	Ceiling (x2)	Thoren/ ON	Parallel	Single	Pos. 100cfm	18.8 (65.8)	15
Case 17	Slot	Ceiling (x2)	Thoren/ ON	Parallel	Single	Pos. 100cfm	18.8 (65.8)	15
Case 18	Low Ind	Ceiling (x2)	Thoren/ ON	Parallel	Single	Pos. 100cfm	18.8 (65.8)	15
Case 19	Radial	Ceiling (x2)	Thoren/ ON	Perpendicular	Single	Neg. 100cfm	18.8 (65.8)	15
Case 20	Slot	Ceiling (x2)	Thoren/ ON	Perpendicular	Single	Neg. 100cfm	18.8 (65.8)	15
Case 21	Low Ind	Ceiling (x2)	Thoren/ ON	Perpendicular	Single	Neg. 100cfm	18.8 (65.8)	15
Case 22	Radial	Low (x4)	Thoren/ ON	Perpendicular	Single	Neg. 100cfm	18.8 (65.8)	15
Case 23	Slot	Low (x4)	Thoren/ ON	Perpendicular	Single	Neg. 100cfm	18.8 (65.8)	15
Case 24	Low Ind	Low (x4)	Thoren/ ON	Perpendicular	Single	Neg. 100cfm	18.8 (65.8)	15
Case 25 *	Radial	Ceiling (x2)	Thoren/ ON	Parallel	Single	Neg. 100cfm	18.8 (65.8)	15
Case 26 *	Slot	Ceiling (x2)	Thoren/ ON	Parallel	Single	Neg. 100cfm	18.8 (65.8)	15
Case 27 *	Low Ind	Ceiling (x2)	Thoren/ ON	Parallel	Single	Neg. 100cfm	18.8 (65.8)	15
Case 28	Low Ind	Low (x4)	Thoren/ ON	Parallel	Single	Neg. 100cfm	16.8 (62.2)	10
Case 29	Low Ind	Low (x4)	Thoren/ ON	Parallel	Single	Neg. 100cfm	11.0 (51.8)	5
Case 30	Low Ind	Low (x4)	Thoren/ ON	Parallel	Single	Neg. 100cfm	19.8 (67.6)	20
Case 31	Radial	Low (x4)	Thoren/ ON	Perpendicular	Double	Neg. 100cfm	17.5 (63.5)	15
Case 32	Slot	Low (x4)	Thoren/ ON	Perpendicular	Double	Neg. 100cfm	17.5 (63.5)	15
Case 33	Low Ind	Low (x4)	Thoren/ ON	Perpendicular	Double	Neg. 100cfm	17.5 (63.5)	15
Case 34	Radial	Ceiling (x2)	Thoren/ ON	Perpendicular	Double	Neg. 100cfm	17.5 (63.5)	15
Case 35	Slot	Ceiling (x2)	Thoren/ ON	Perpendicular	Double	Neg. 100cfm	17.5 (63.5)	15
Case 36	Low Ind	Ceiling (x2)	Thoren/ ON	Perpendicular	Double	Neg. 100cfm	17.5 (63.5)	15
Case 37	Radial	Ceiling (x1) / Low (x4) (Mass flow in 50/50 split)	Thoren/ ON	Parallel	Single	Neg. 100cfm	18.8 (65.8)	15
Case 38	Slot	Ceiling (x1) / Low (x4) (Mass flow in 50/50 split)	Thoren/ ON	Parallel	Single	Neg. 100cfm	18.8 (65.8)	15
Case 39	Low Ind	Ceiling (x1) / Low (x4) (Mass flow in 50/50 split)	Thoren/ ON	Parallel	Single	Neg. 100cfm	18.8 (65.8)	15

Case Name	Supply Diffuser Type	Exhaust Location and Number	Change Station (Design/ Status)	Rack orientation	Rack density	Pressure of Room to Corridor	Supply Temperature °C (°F)	Supply ACH
Case 40	Radial	Ceiling (x4)	Thoren/ ON	Parallel	Single	Neg. 100cfm	18.8 (65.8)	15
Case 41	Slot	Ceiling (x4)	Thoren/ ON	Parallel	Single	Neg. 100cfm	18.8 (65.8)	15
Case 42	Low Ind	Ceiling (x4)	Thoren/ ON	Parallel	Single	Neg. 100cfm	18.8 (65.8)	15
Case 43	Low Ind (rotated by 90°)	Ceiling (x2)	Thoren/ ON	Parallel	Single	Neg. 100cfm	18.8 (65.8)	15
Case 44	Radial (rotated by 90°)	Ceiling (x2)	Thoren/ ON	Parallel	Single	Neg. 100cfm	18.8 (65.8)	15
Case 45	Radial	Ceiling (x2)	Thoren/ ON	Parallel	Single	Neg. 50cfm	18.8 (65.8)	15
Case 46	Radial	Ceiling (x2)	Thoren/ ON	Parallel	Single	Neutral	18.8 (65.8)	15
Case 47	Radial	Ceiling (x2)	Thoren/ ON	Parallel	Single	Pos. 50cfm	18.8 (65.8)	15
Case 48	Radial	Ceiling (x2)	Thoren/ ON (swapped with rack1)	Parallel	Single	Neg. 100cfm	18.8 (65.8)	15
Case 49	Radial	Ceiling (x2)	Thoren/ ON (swapped with rack2)	Parallel	Single	Neg. 100cfm	18.8 (65.8)	15
Case 50	Radial	Ceiling (x2)	Thoren/ ON (swapped with rack3)	Parallel	Single	Neg. 100cfm	18.8 (65.8)	15
Case 51	Radial	Ceiling (x2)	Thoren/ ON (swapped with rack4)	Parallel	Single	Neg. 100cfm	18.8 (65.8)	15
Case 52	Radial	Ceiling (x2)	Thoren/ ON (swapped with rack5)	Parallel	Single	Neg. 100cfm	18.8 (65.8)	15
Case 53	Radial	Ceiling (x2)	Lab. Prod. / ON	Parallel	Single	Neg. 100cfm	18.8 (65.8)	15
Case 54	Slot	Ceiling (x2)	Lab. Prod. / ON	Parallel	Single	Neg. 100cfm	18.8 (65.8)	15
Case 55	Low Ind	Ceiling (x2)	Lab. Prod. / ON	Parallel	Single	Neg. 100cfm	18.8 (65.8)	15
Case 56	Radial	High (x4)	Lab. Prod. / ON	Parallel	Single	Neg. 100cfm	18.8 (65.8)	15
Case 57	Radial	Low (x4)	Lab. Prod. / ON	Parallel	Single	Neg. 100cfm	18.8 (65.8)	15
Case 58	Slot	High (x4)	Lab. Prod. / ON	Parallel	Single	Neg. 100cfm	18.8 (65.8)	15
Case 59	Slot	Low (x4)	Lab. Prod. / ON	Parallel	Single	Neg. 100cfm	18.8 (65.8)	15
Case 60	Low Ind	High (x4)	Lab. Prod. / ON	Parallel	Single	Neg. 100cfm	18.8 (65.8)	15
Case 61	Low Ind	Low (x4)	Lab. Prod. / ON	Parallel	Single	Neg. 100cfm	18.8 (65.8)	15
Case 62	Low Ind	Low (x4)	Thoren/ ON	Perpendicular	Double	Neg. 100cfm	6.6 (43.9)	5
Case 63	Low Ind	Low (x4)	Thoren/ ON	Perpendicular	Double	Neg. 100cfm	14.8 (58.6)	10
Case 64	Low Ind	Low (x4)	Thoren/ ON	Perpendicular	Double	Neg. 100cfm	18.9 (66.0)	20
Case 65	Low Ind	Low (x4)	Lab. Prod. / ON	Perpendicular	Double	Neg. 100cfm	17.5 (63.5)	15
Case 66	Low Ind	Low (x4)	Lab. Prod. / ON	Perpendicular	Double	Neg. 100cfm	6.6 (43.9)	5
Case 67	Low Ind	Low (x4)	Lab. Prod. / ON	Perpendicular	Double	Neg. 100cfm	14.8 (58.6)	10
Case 68	Low Ind	Low (x4)	Lab. Prod. / ON	Perpendicular	Double	Neg. 100cfm	18.9 (66.0)	20

Case Name	Supply Diffuser Type	Exhaust Location and Number	Change Station (Design/ Status)	Rack orientation	Rack density	Pressure of Room to Corridor	Supply Temperature °C (°F)	Supply ACH
Case 69	Radial	High (x4) / Low (x4) (Mass flow split evenly amongst exhausts)	Thoren/ ON	Parallel	Single	Neg. 100cfm	18.8 (65.8)	15
Case 70	Slot	High (x4) / Low (x4) (Mass flow split evenly amongst exhausts)	Thoren/ ON	Parallel	Single	Neg. 100cfm	18.8 (65.8)	15
Case 71	Low Ind	High (x4) / Low (x4) (Mass flow split evenly amongst exhausts)	Thoren/ ON	Parallel	Single	Neg. 100cfm	18.8 (65.8)	15
Case 72	Radial	High (x4) / Low (x2) (Mass flow split evenly amongst exhausts)	Thoren/ ON	Parallel	Single	Neg. 100cfm	18.8 (65.8)	15
Case 73	Slot	High (x4) / Low (x2) (Mass flow split evenly amongst exhausts)	Thoren/ ON	Parallel	Single	Neg. 100cfm	18.8 (65.8)	15
Case 74	Low Ind	High (x4) / Low (x2) (Mass flow split evenly amongst exhausts)	Thoren/ ON	Parallel	Single	Neg. 100cfm	18.8 (65.8)	15
Case 75	Radial	Ceiling (x1) / Low (x4) (Mass flow in 50/50 split)	Lab. Prod. / ON	Parallel	Single	Neg. 100cfm	18.8 (65.8)	15
Case 76 **	Radial	Ceiling (x2)	Thoren/ ON	Parallel	Single	Neg. 100cfm	19.2 (66.6)	15
Case 77 **	Slot	Ceiling (x2)	Thoren/ ON	Parallel	Single	Neg. 100cfm	19.2 (66.5)	15
Case 78 **	Low Ind	Ceiling (x2)	Thoren/ ON	Parallel	Single	Neg. 100cfm	19.2 (66.6)	15
Case 79	Radial	2 Door exhausts	Thoren/ ON	Parallel	Single	Neg. 100cfm	18.8 (65.8)	15
Case 80	Slot	2 Door exhausts	Thoren/ ON	Parallel	Single	Neg. 100cfm	18.8 (65.8)	15
Case 81	Low Ind	2 Door exhausts	Thoren/ ON	Parallel	Single	Neg. 100cfm	18.8 (65.8)	15
Case 82	Radial	2 Door exhausts	Thoren/ ON	Parallel	Single	Neg. 100cfm	18.8 (65.8)	15
Case 83	Slot	2 Door exhausts	Thoren/ ON	Perpendicular	Double	Neg. 100cfm	17.5 (63.5)	15
Case 84	Low Ind	2 Door exhausts	Thoren/ ON	Perpendicular	Double	Neg. 100cfm	17.5 (63.5)	15
Case 85	Radial	Low (x4)	Lab. Prod / ON	Perpendicular	Double	Neg. 100cfm	17.5 (63.5)	15
Case 86	Slot	Low (x4)	Lab. Prod./ ON	Perpendicular	Double	Neg. 100cfm	17.5 (63.5)	15

Case Name	Supply Diffuser Type	Exhaust Location and Number	Change Station (Design/ Status)	Rack orientation	Rack density	Pressure of Room to Corridor	Supply Temperature °C (°F)	Supply ACH
Case 87	Radial	Low (x4)	Thoren/ ON	Parallel	Reduced	Neg. 100cfm	19.2 (66.6)	15
Case 88	Slot	Low (x4)	Thoren/ ON	Parallel	Reduced	Neg. 100cfm	19.2 (66.6)	15
Case 89	Low Ind	Low (x4)	Thoren/ ON	Parallel	Reduced	Neg. 100cfm	19.2 (66.6)	15
Case 90	Radial	Ceiling (x2)	Thoren/ ON	Perpendicular all 5 on 1 wall	Single	Neg. 100cfm	18.8 (65.8)	15
Case 91	Slot	Ceiling (x2)	Thoren/ ON	Perpendicular all 5 on 1 wall	Single	Neg. 100cfm	18.8 (65.8)	15
Case 92	Low Ind	Ceiling (x2)	Thoren/ ON	Perpendicular all 5 on 1 wall	Single	Neg. 100cfm	18.8 (65.8)	15
Case 93	Radial	Ceiling (x2)	Thoren/ ON	Perpendicular all 5 on 1 wall	Double	Neg. 100cfm	17.5 (63.5)	15
Case 94	Slot	Ceiling (x2)	Thoren/ ON	Perpendicular all 5 on 1 wall	Double	Neg. 100cfm	17.5 (63.5)	15
Case 95	Low Ind	Ceiling (x2)	Thoren/ ON	Perpendicular all 5 on 1 wall	Double	Neg. 100cfm	17.5 (63.5)	15
Case 96	Radial	Ceiling (x2)	Lab. Prod. / ON	Perpendicular all 5 on 1 wall	Double	Neg. 100cfm	17.5 (63.5)	15
Case 97	Slot	Ceiling (x2)	Lab. Prod. / ON	Perpendicular all 5 on 1 wall	Double	Neg. 100cfm	17.5 (63.5)	15
Case 98	Low Ind	Ceiling (x2)	Lab. Prod. / ON	Perpendicular all 5 on 1 wall	Double	Neg. 100cfm	17.5 (63.5)	15
Case 99 ***	Radial	Ceiling (x2)	Thoren/ ON	Parallel	Single	Neg. 100cfm	22.2 (72.0)	15
Case 100 ***	Radial	Low (x4)	Thoren/ ON	Parallel	Single	Neg. 100cfm	22.2 (72.0)	15
Case 101 ***	Low Ind	Low (x4)	Lab. Prod. / ON	Perpendicular	Double	Neg. 100cfm	22.2 (72.0)	5

* Sealed cages instead of open cages

** Room 4.26m (14' 0") wide instead of 3.66m (12' 0")

*** Supply air temperature fixed at 22.2 °C (72.0 °F). In all other cases, the exhaust temperature was set to be 22.2 °C (72.0 °F) by setting the supply air temperature appropriately.

Table 2.02 Cases Cross-Referenced against Supply Diffuser Type

Supply Diffuser Type	Case Number
Radial	Basecase, 02-03, 10-11, 16, 19, 22, 25, 31, 34, 37, 40, 44*, 45-53, 56-57, 69, 72, 75-76, 79, 82, 85, 87, 90, 93, 96, 99-100
Slot	04-06, 12-13, 17, 20, 23, 26, 32, 35, 38, 41, 54, 58-59, 70, 73, 77, 80, 83, 86, 88, 91, 94, 97
Low Induction	07-09, 14-15, 18, 21, 24, 27-30, 33, 36, 39, 42, 43*, 55, 60-68, 71, 74, 78, 81, 84, 89, 92, 95, 98, 101

*Indicates that diffuser rotated by 90°

Table 2.03 Cases Cross-Referenced against Exhaust Location and Number

Exhaust Location and Number	Case Number
Ceiling (x2)	Basecase, 04, 07, 10, 12, 14, 16-21, 25-27, 34-36, 43-55, 76-78, 90-99
High (x4)	02, 05, 08, 56, 58, 60
Low (x4)	03, 06, 09, 11, 13, 15, 22-24, 28-33, 57, 59, 61-68, 85-89, 100-101
Ceiling (x1) / Low (x4) (Mass flow in 50/50 split)	37-39, 75
Ceiling (x4)	40-42
High (x4)/ Low (x4) (Mass flow split evenly amongst exhausts)	69-71
High (x4)/ Low (x2) (Mass flow split evenly amongst exhausts)	72-74
2 Door Exhausts	79-84

Table 2.04 Cases Cross-Referenced against Change Station Design and Status

Change Station	Case Number
ON*	Basecase – 09, 16-101
OFF*	10-15
Thoren Design	Basecase –52**, 62-64, 69-74, 76-84, 87-95, 99-100
Laboratory Products Design	53-61, 65-68, 75, 85-86, 96-98, 101

* Change in status only considered for Thoren Design Change Station

** Cases 10 to 15 had Thoren Design Change Station switched off

Table 2.05 Cases Cross-Referenced against Pressurization of Room Relative to Corridor

Pressurization of Room to Corridor	Case Number
Neg. 100 cfm	Basecase –15, 19-44, 48-101
Pos. 100 cfm	16-18
Neg. 50 cfm	45
Neutral	46
Pos. 50 cfm	47

Table 2.06 Cases Cross-Referenced against Pressurization of Room Relative to Corridor

Rack Orientation	Case Number
Parallel	Basecase – 18, 25-30, 37-61***, 69-82, 87-89, 99-100
Perpendicular	19-24, 31-36, 62-68, 83-86,101
Perpendicular All 5 on 1 Wall	90-98

***Cases 48 to 52 had change stations swapped with each of five racks

Table 2.07 Cases Cross-Referenced against Status of Cage Side Cracks

Status of Cage Side Cracks	Case Number
Open	Basecase – 24, 28-101
Sealed	25-27

Table 2.08 Cases Cross-Referenced against Density of Cages in Rack

Density of Cages in Rack	Case Number
Single	Basecase – 30, 37-61, 69-82, 90-92, 99-100
Double	31-36, 62-68, 83-86, 93-98, 101
Reduced	87-89

Table 2.09 Cases Cross-Referenced against Room Air Change Rate

Room Air Change Rate (ACH)	Case Number
5	29, 62, 66, 101
10	28, 63, 67
15	Basecase – 27, 31-61, 65, 69-100
20	30, 64, 68

Table 2.10 Cases Cross-Referenced against Room Width

Room Width (ft)	Case Number
12	Basecase-75, 79-101
14	76-78

Table 2.11 Cases Cross-Referenced against Supply Temperature (1)

Supply Temperature	Case Number
Supply Temperature set such that air is at 22.22°C (72°F) at Exhaust	Basecase – 98
22.22°C	99-101

Table 2.12 Cases Cross-Referenced against Supply Temperature (2)

Supply Temperature	Case Number
6.60	62, 66
11.00	29
14.80	63, 67
16.80	28
17.50	31-36, 65, 83-86, 93-98
18.80	Basecase – 09, 16-27, 37-61, 69-75, 79-82, 90-92
18.90	64, 68
19.20	76-78, 87-89
19.80	30
20.70	10-15
22.22****	99-101

****In these cases, the supply air temperature was set to 22.22 °C (72 °F). In all other cases, the exhaust air temperature was set to be 22.22 °C (72 °F) by setting supply air temperature appropriately.

2.3 How the Data are Presented

This section presents the outcome of the CFD simulations. There are a number of ways of presenting the results produced with the CFD models. These can be either based upon visualization of the CFD results files or based upon automated analysis of the data contained within those files. The former provides a qualitative approach and can be useful to understand the flow patterns produced within the rooms. The latter provides quantitative measurements of mean values for temperature, CO₂, and NH₃ concentrations and the relative humidity in the cages and the room.

2.3.1 Visualizing the Flow—A Qualitative Approach

Three approaches are used to display the CFD results directly. Two of these show the data in selected planes (planar slices) while the third provides a view in a three-dimensional visualization of the flow of selected air stream.

2.3.1.1 Using planar slices through the model

The results can be displayed in diagrammatic form, e.g., figure 2.23 showing the concentration of CO₂ (kg CO₂/kg air) as a solid color fill and figure 2.24 showing air speed (m/s) as velocity vectors showing both direction as well as magnitude of the airflow. Values for both can be obtained from the color bar (key) in each diagram. The left key is the air speed in m/s (0.1 m/s is equivalent to 20 fpm) and the right key is the mass fraction of CO₂ in g (species)/kg air.

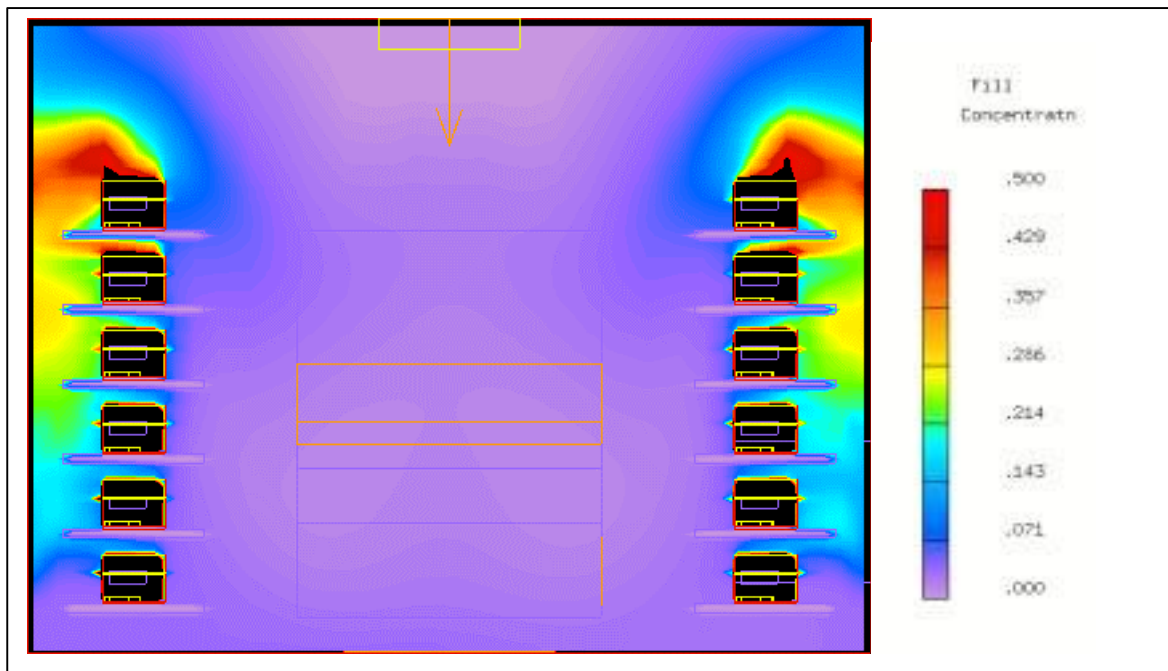

Figure 2.23 Concentration (CO₂) Distribution (g/kg)

The CFD simulations were only solved directly for the concentration of CO₂. Concentrations of NH₃ are calculated in the post-processing stage of the quantitative analysis using a factor derived from the relative generation of CO₂ and NH₃. This factor varies according to the relative humidity in the cages and the number of days that have elapsed since the cage bedding was changed.

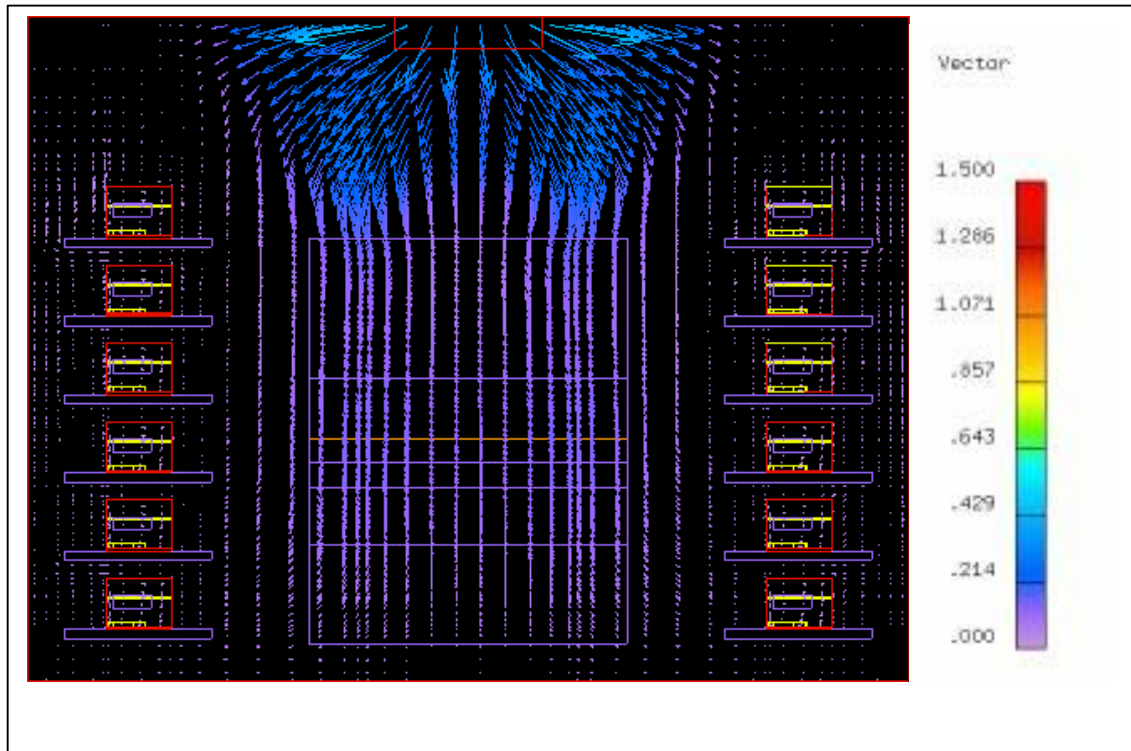

Figure 2.24 Velocity Vectors (m/s)

The vectors are plotted so that the tail of the arrow is at the point where the value was calculated and points in the direction of air movement. In 2-D planar views the length of the arrow indicates the 2-D magnitude of the velocity (the arrow is projected onto the plane of viewing) when compared to a reference vector, while the color indicates the overall magnitude of air speed at the tail.

To aid analysis, the color scales are set the same on different diagrams as much as possible. For example, the temperature scale runs from 18.0 °C to 25 °C (64.4 °F to 77.0 °F). The concentration scale runs from 0.0 to 5 g/kg or from 0.0 to 0.5g/kg depending on whether the plane is concerned with showing the concentrations inside the cages or outside in the room, where the concentrations are generally much lower. Values outside the range will appear as blank areas in the solid fill or a region with no vectors. If lower than the scale, the area is surrounded by colors at the bottom of the range and above by colors at the top of the range.

The vectors show the radial pattern of flow leaving the radial diffuser supply and the strong down flow in the center of the room. The airflow over the cages is very low in this view, as the velocity vectors are very small, appearing virtually as dots. The concentration plot shows high concentrations around the cages at the top of the racks. Even though the velocities are very low around the cages, the tendency for the flow to go over the cages towards the rear wall is clearly evident in the way the concentration levels are much higher behind the cages than in the center of the room.

2.3.1.2 Using three-dimensional flow visualization

Three-dimensional flow visualization allows us to understand the interaction of complex flows. Figure 2.25 shows the airflow from the radial supply in the baseline model. The air is colored according to the temperature of the air, blue through green, yellow and red representing low to high temperatures. Various recirculation regions are visible as the air follows a very complex path from the white supply down the middle of the room and back up to the red exhaust, which is also situated on the ceiling.

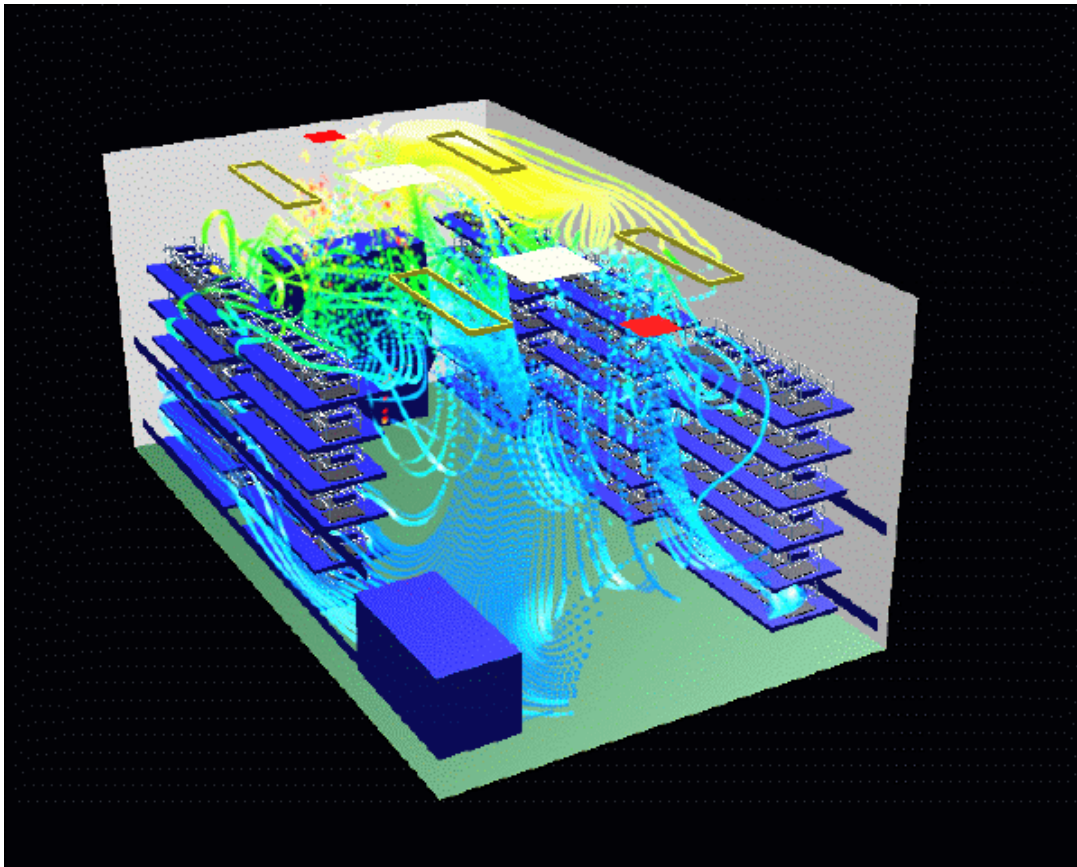

Figure 2.25 3-Dimension Flow Visualization

2.3.2 *Quantitative Analysis*

Although visual inspection of the CFD results can give much insight into the conditions within a room, it does not allow an efficient comparison of one room simulation to another. In order to allow us to compare the various room models it was necessary to define some quantitative measures for the cages and the room as a whole. The following parameters were considered important in this study:

Cages:

- Mean temperature in each cage
- Mean relative humidity in each cage
- Mean CO₂ and NH₃ concentrations in each cage

The mean value for each cage was also further averaged to provide a single value representing the “average cage” in the room. These values were calculated for the “occupied zone” of each cage, i.e., the region below the wire mesh grille, which represents the environment the mice would normally experience.

Room:

- Mean breathing zone temperature
- Mean breathing zone relative humidity
- Mean breathing zone CO₂ and NH₃ concentrations

The breathing zone is defined as a region in the center of the room between the racks of cages and between the door and change station, at a height from 1.50m to 1.80m (4'11" to 5'11").

These parameters were derived from the many millions of numbers produced by the CFD simulations as follows:

Temperature:

The mean temperature was derived from the actual temperature in each grid cell of the CFD simulation by multiplying the temperature by the volume of the grid cell and dividing by the total volume of the space (the cage volume or the “breathing zone” volume in the room).

Relative Humidity:

The relative humidity was calculated by first determining the moisture content in each cage by taking the mass fraction values calculated in the CFD and multiplying by the ratio

of the experimentally determined moisture generation rate (0.83 g/hr) to the nominal source rate (0.76g/hr). This additional water content was then added to the moisture in the supply air (8.40e-3 kg water per kg air, 50 percent RH at 22.2 °C (72.0 °F) for all cases except those at very low (5 ACH) air supply rates where 5.40e-3 kg/kg was used. The RH can be determined from a Psychrometric chart from the total moisture content of the air and the temperature of the cage

CO₂ (ppm):

The ppm concentrations for CO₂ in air were calculated directly from the simulated mass fraction information in the CFD results by multiplying the mass fraction value by the ratio of the actual generation rate to the nominal generation rate (0.9 / 0.76) and the ratio of molecular weights (29/44).

NH₃ (ppm):

The concentration of NH₃ was also derived from the mass fraction values calculated in the CFD simulations, but the process was more complicated. First, the relative humidity in every cage is calculated as described above. The average RH for all the cages was then used to calculate the generation rate of NH₃ for each day in the 10-day cycle using the experimental data shown in section 4.1.2.8.2. RH values below the minimum range (61 percent) for the experimental data used the generation rate of the minimum value. RH values above the maximum range (81 percent) used the generation rate of the maximum value as it was deemed unsafe to extrapolate outside the ranges. Once the generation rate to be used was determined, the ppm concentration of NH₃ was calculated in the same manner as the CO₂ concentrations.

As each day had a different NH₃ generation rate, the NH₃ concentrations are different on each day. However as the underlying mass fraction information and RH information does not change on a daily basis in the simulations, room performance can be compared by using the results for any of the 10 days. For ease of comparison, results are presented for day 4, which corresponds to the day most widely used to change the bedding in the mice cages.

In addition to the mean values it is also possible to get minimum and maximum values. In most cases the minimum value is not interesting but the maximum value may provide information. In particular, the maximum NH₃ concentration can be important, as it is not always necessary for the room average value to be so high that the scientists can detect it by smell. A high value in a single location could be enough.

The results for each room are summarized in Volume II.

2.3.3 Analysis of the Results for the Baseline Room

Due to the enormous amount of data generated in the CFD runs it is not possible to discuss in detail the results of each case. Initially, this section will look at the flow patterns and the quantitative results generated in the baseline case as this will give a basic understanding of the animal room airflows. Subsequent sections will then compare results for the various room configurations without necessarily discussing each room.

The basecase (case 01) had two radial supply diffusers (supplying 540 cfm at 18.8 °C (66.0 °F)) and two ceiling mounted exhausts. Five racks of 42 cages are placed along to the side walls. See figure 2.02.

Figures 2.26 to 2.28 show velocity vectors, temperature distribution, and CO₂ distribution in a planar section down the center line of the room. The two supplies, with downward facing vectors, and the two exhausts are clearly visible on the ceiling. The inflow of makeup air coming from the cracks around the door is also obvious. The change station generates high temperatures in its vicinity, which causes a strong upward flow of air. This flow causes the downward flow from the supplies to be deflected away from the change station towards the door. The concentration plot shows little variation in CO₂ concentration apart from some small regions behind the change station and very near the ceiling.

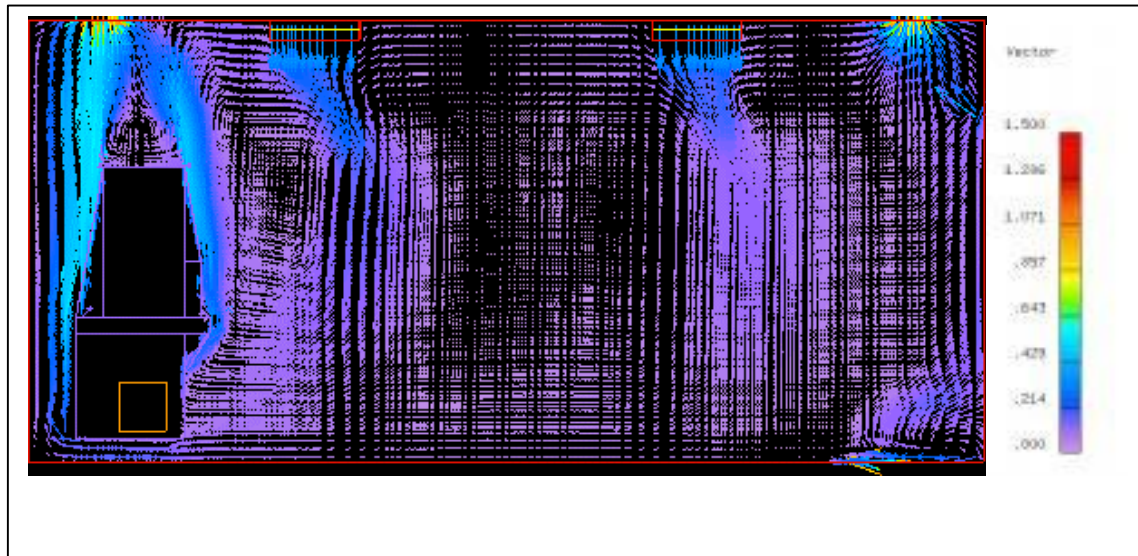

Figure 2.26 Basecase (Case 01): Velocity Vectors

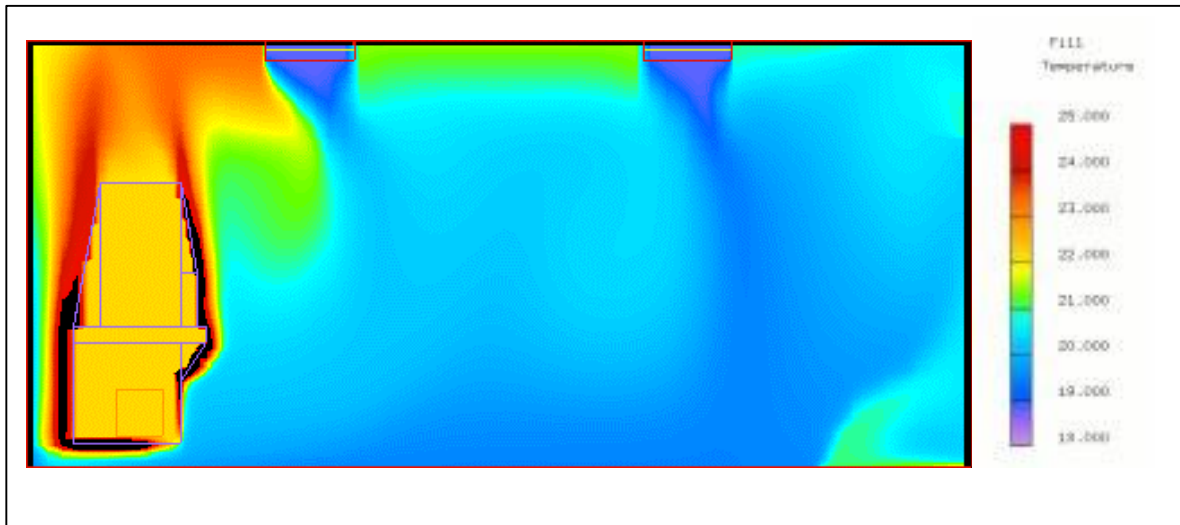

Figure 2.27 Basecase (Case 01): Temperature Distribution ($^{\circ}\text{C}$)

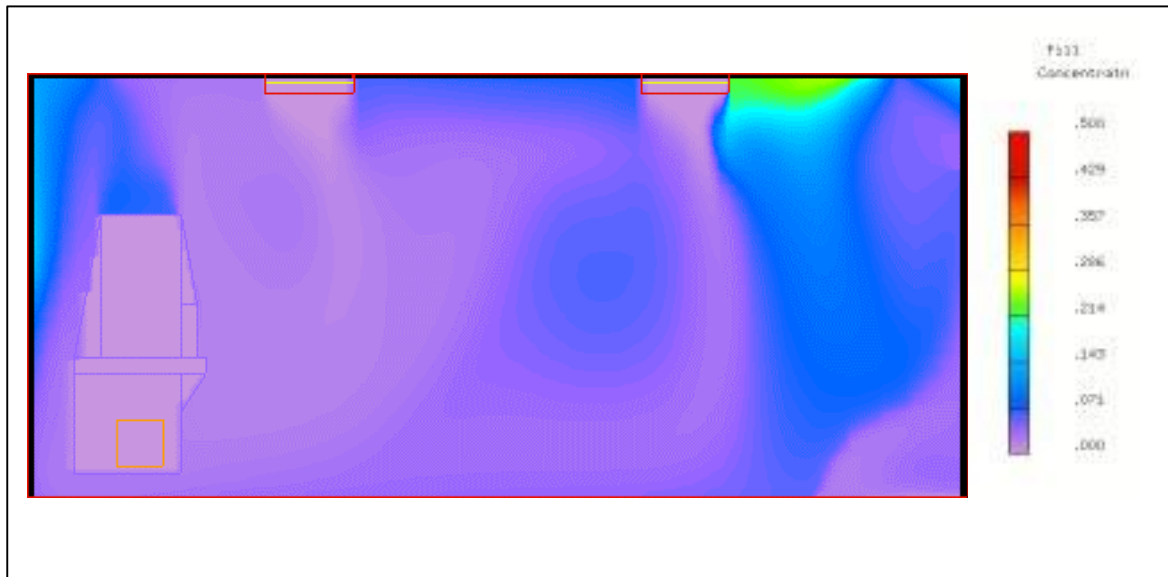

Figure 2.28 Basecase (Case 01): CO₂ Concentration Distribution (g/kg)

Figures 2.29 to 2.31 show velocity vectors, temperature distribution, and CO₂ distribution in a planar section cutting through the center of the supply nearest the change station. The characteristic pattern of the flow from the supply is visible, as is the low flow around the cages. The temperature in the room shows signs of stratification with significantly higher temperatures

near the ceiling. The temperature of the cages is higher than that of the surrounding room air, and rises according to the height of the shelf on which the cage sits.

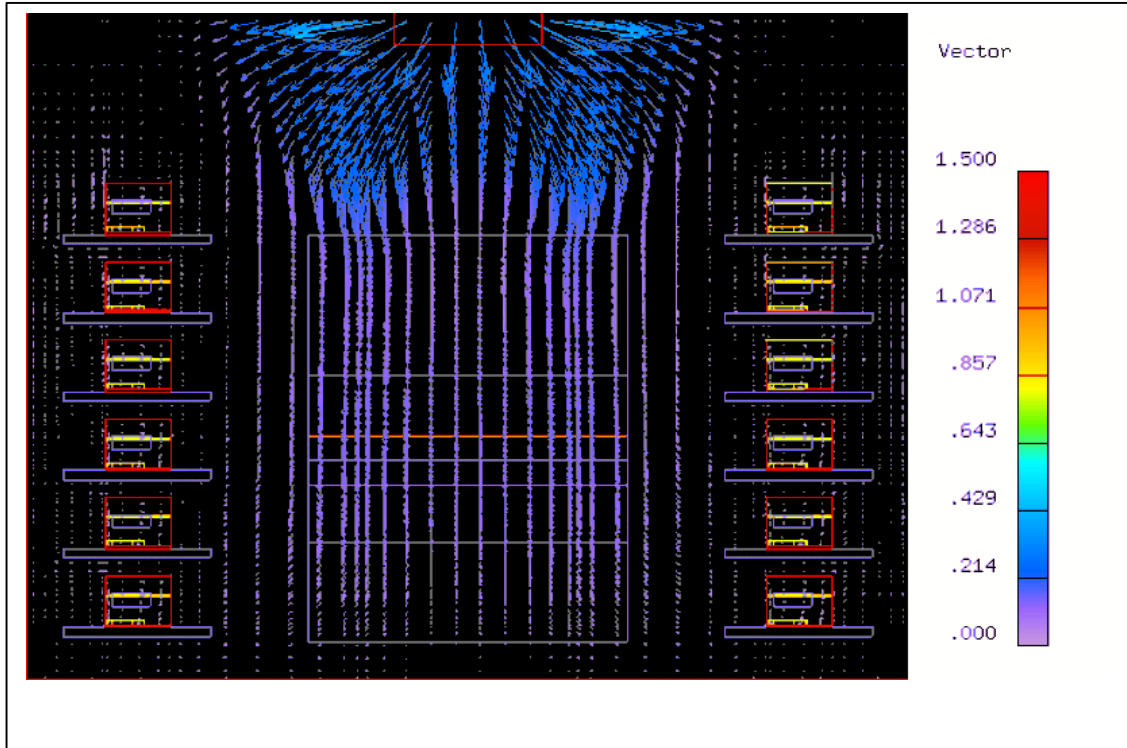

Figure 2.29 Basecase (Case 01): Velocity Vectors (m/s)

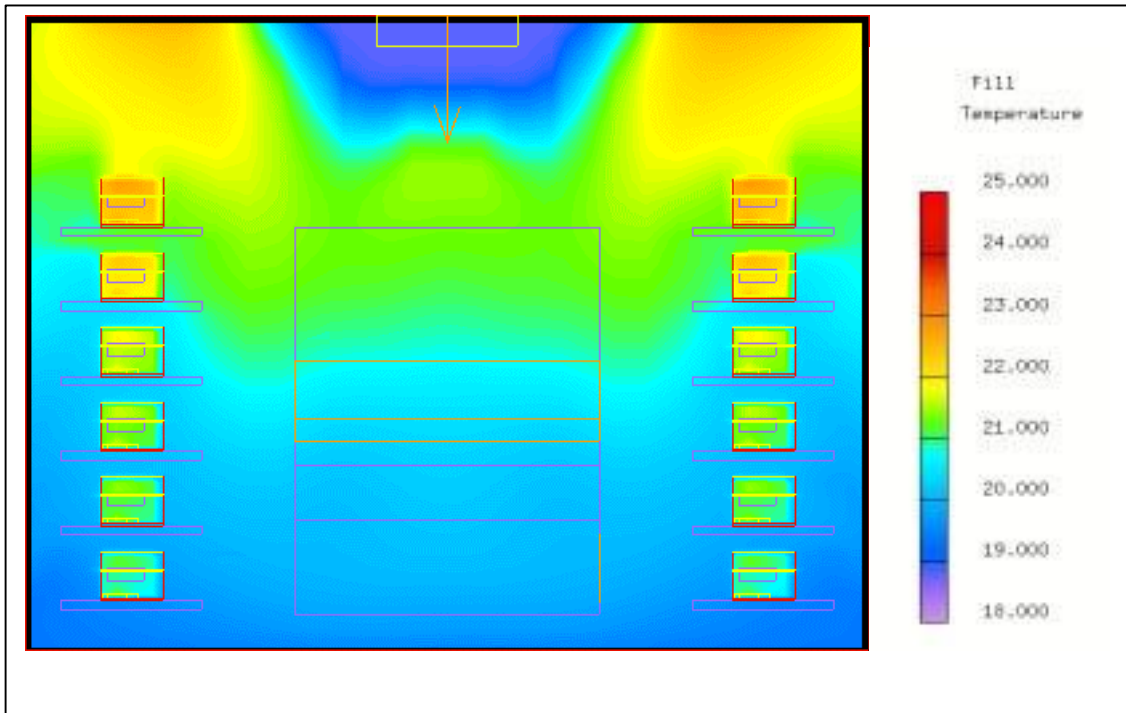

Figure 2.30 Basecase (Case 01): Temperature Distribution (°C)

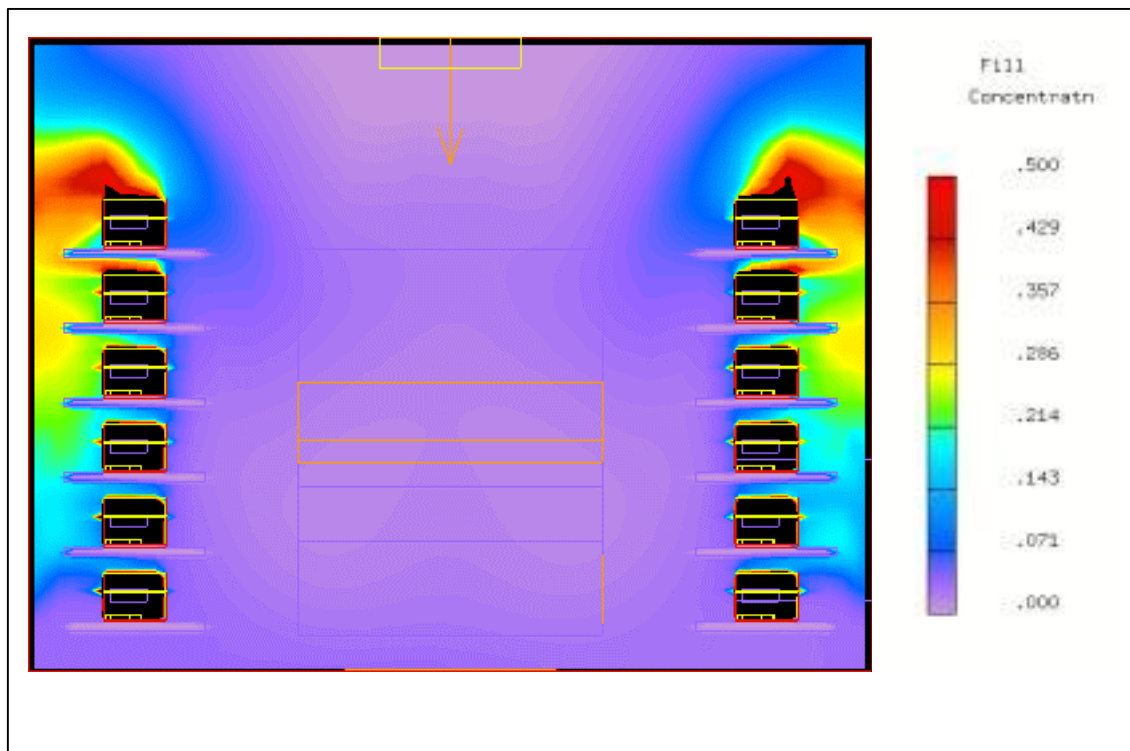

Figure 2.31 Basecase (Case 01): CO₂ Distribution (g/kg)

The plot of concentration of CO₂ is scaled to show the variation within the room air. The values within the cages are much higher. The concentration also rises with increasing height of the cage, which indicates that the lower cages are being ventilated better than the upper ones. This is perhaps to be expected as the flow from the supply goes down in the open center part of the room and passes through the racks towards the walls and then upwards towards the ceiling exhausts.

The CFD simulations only solved directly for the concentration of CO₂. Concentrations of NH₃ are calculated in the post processing stage of the quantitative analysis using a factor derived from the relative generation of CO₂ and NH₃. This factor varies according to the relative humidity in the cages and the number of days that have elapsed since the cage bedding was changed. So although the values shown are incorrect, the color fill for CO₂ does show the distribution of NH₃ or indeed any airborne particulate matter that flows with the air which originates from the cages. This is possible, as the concentrations of both CO₂ and NH₃ in the air are so low as to have no real effect on the density of the air, CO₂, and NH₃ mixture. In effect the CO₂ and NH₃ are intimately mixed with and flow with the air.

Figures 2.32 and 2.33 show temperature and concentration distributions in planar slices through the racks. Significantly higher temperatures and concentrations within the cages are clearly visible.

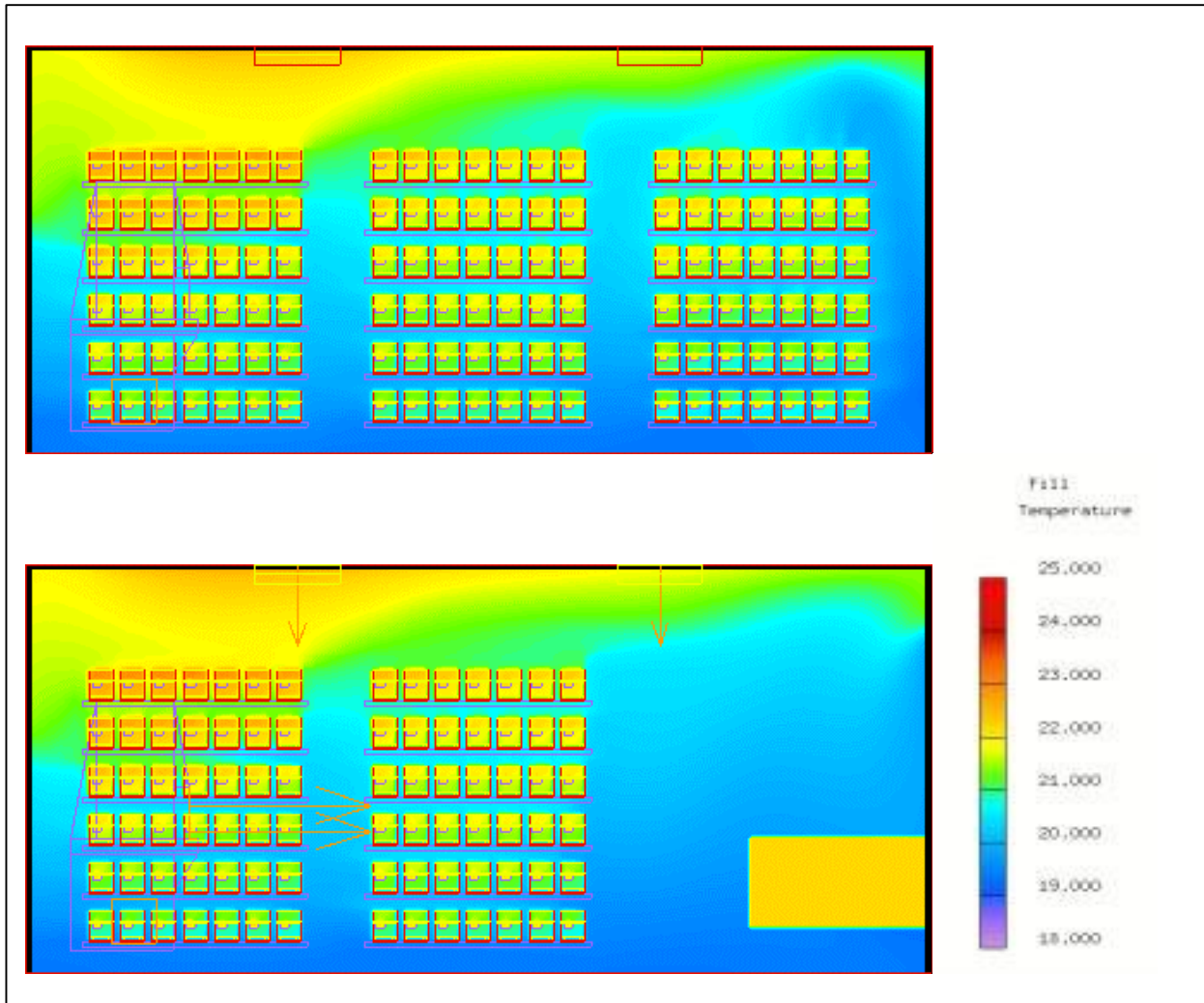

Figure 2.32 Basecase (Case 01): Temperature Distribution (°C)

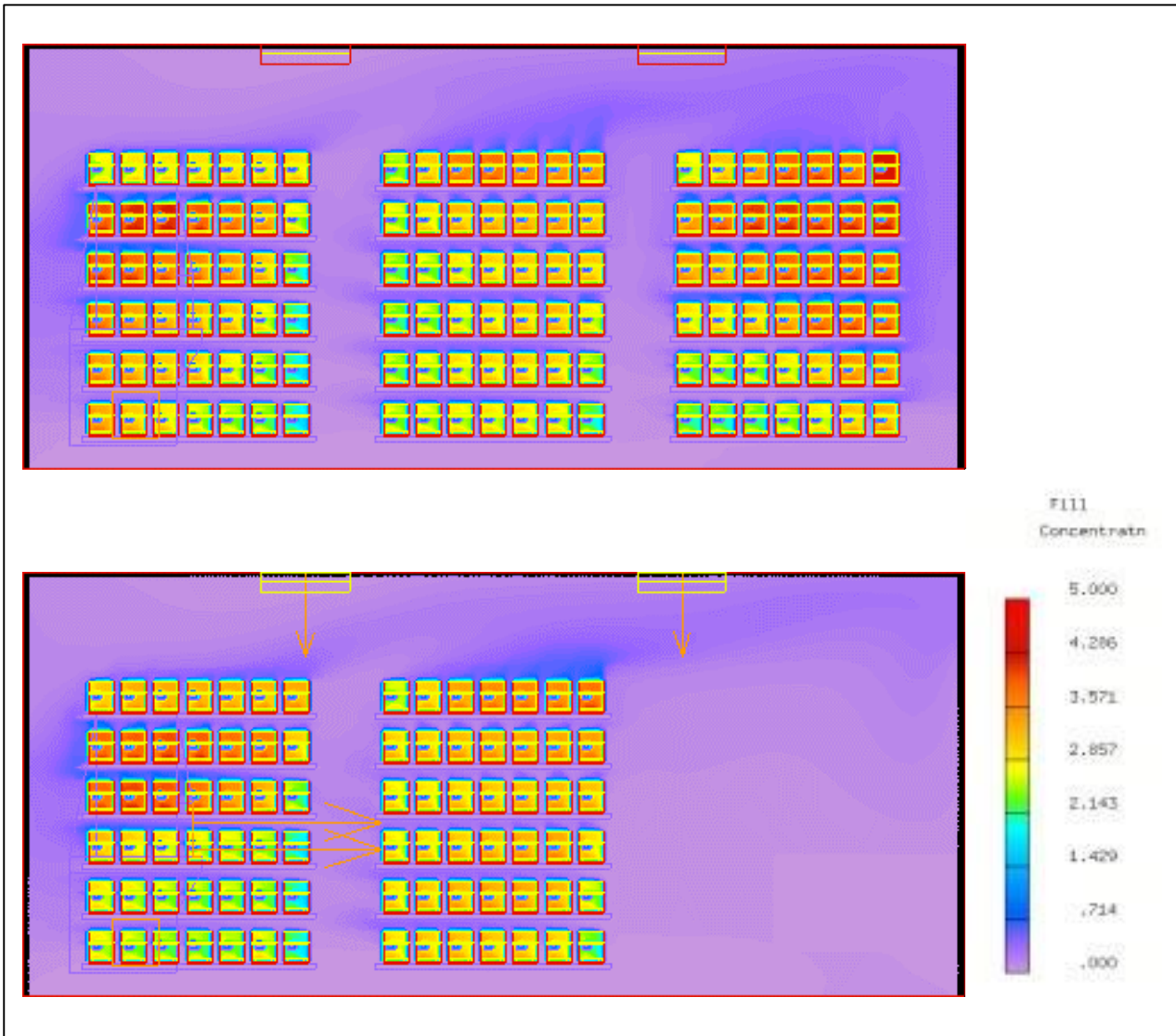

Figure 2.33 Basecase (Case 01): CO₂ Concentration (g/kg)

The temperature and CO₂ concentration for the scientist’s breathing zone is shown in the table below:

Table 2.13 Basecase (Case 01): Temperature, CO₂ Concentration and RH in the Breathing Zone

	Temperature (°C (°F))	CO ₂ (ppm)	RH (percent)
Mean	20.3 (68.5)	36	55.4
Maximum	21.8 (71.2)	137	-
Standard Dev.	0.5 (0.9)	20	-

The temperature is cool in the room up to the top of the breathing zone compared to the design exhaust temperature of 22.2 °C (72.0 °F). This is due to the stratification occurring in the room in combination with the location of the exhausts on the ceiling, which means that the highest temperature occurs at the exhaust at the top of the room.

The variation of NH₃ concentration in ppm in the breathing zone over the 10-day cycle is shown below:

Table 2.14 Basecase (Case 01): NH₃ Room Breathing Zone Concentrations (ppm) over a 10-Day Cycle in the Breathing Zone

	Day									
	1	2	3	4	5	6	7	8	9	10
Mean	0.02	0.04	0.06	0.11	0.18	0.26	0.40	0.49	0.59	0.63
Max	0.07	0.14	0.21	0.40	0.68	1.01	1.51	1.88	2.55	2.43

This shows that the performance of the ventilation system in this room configuration is very satisfactory. The average NH₃ concentration does not rise above 0.6 ppm even after 10 days. However, the peak value rises above 1 ppm after 6 days. This indicates that any Scientist working in the area where the maximum value occurs is likely to remark that NH₃ is noticeable in the room. Too much importance should not be attached to this number because the concentration may only occur in a very small localized region in the room.

The situation in the cages is summarized below:

Table 2.15 Basecase (Case 01): Temperature CO₂ Concentration and RH in the Cages

	Temperature (°C (°F))	CO ₂ (ppm)	RH (percent)
Mean	22.1 (71.8)	2158	66.8
Maximum	23.0 (73.4)	3133	66.8
Standard Dev.	0.4 (0.7)	359	2.6

Table 2.16 Basecase (Case 01): NH₃ Concentrations (ppm) over a 10-Day Cycle in the Cages

	Day									
	1	2	3	4	5	6	7	8	9	10
Mean	1.15	2.18	3.37	6.33	10.66	15.82	23.78	29.51	35.35	38.09
Max	1.67	3.17	4.89	9.19	15.47	22.96	34.53	42.84	51.32	55.30

The average NH₃ concentration in the cages rises from around 1 ppm to over 38 ppm by day 10. By day 5 the average cage NH₃ concentration is over 10 ppm. The NH₃ concentration in the worst single cage in the room (shown in the Max line in table 2.16) is approximately 50 percent higher than the average. Clearly in the latter part of the cycle the cages on average exceed the 25 ppm critical level for NH₃ by day 8 and the worst cage exceeds this value by almost 2 days earlier. That these values are not even higher is due to the good ventilation performance of the basecase room and the relatively low relative humidity values.

In a practical scenario where the bedding is changed after four days the room would not be considered smelly, although the individual cages would be.

The summary sheets for each run also contain three histograms that show the variation of RH concentration and temperature in the cages. The histograms show the number of cages (frequency) that have values which fall in the range between two values marked on the horizontal axis, with only the upper value indicated. For example, in figure 2.34 the column labeled 67 indicates that 35 cages have an RH between 66 percent and 67 percent. The concentration histogram can be converted to CO₂ and NH₃ concentrations by multiplying the kg/kg values given in the chart by a conversion factor. The conversion factors are given for the basecase in table 2.17 below:

Table 2.17 Conversion Factor between kg/kg and ppm for CO₂ and NH₃ Concentrations

Day	CO ₂	NH ₃
1	785000	418
2	785000	795
3	785000	1225
4	785000	1922
5	785000	2848
6	785000	3443
7	785000	8409
8	785000	8483
9	785000	8442
10	785000	11384

The plots for the basecase are shown below. These show virtually a standard Gaussian bell-shaped distribution around the mean values. Comparison of these histograms for the different

room configurations identify rooms that provide uniform conditions in all cages or those that have excessive variation in cage conditions that could influence the experimental investigation being undertaken in the room.

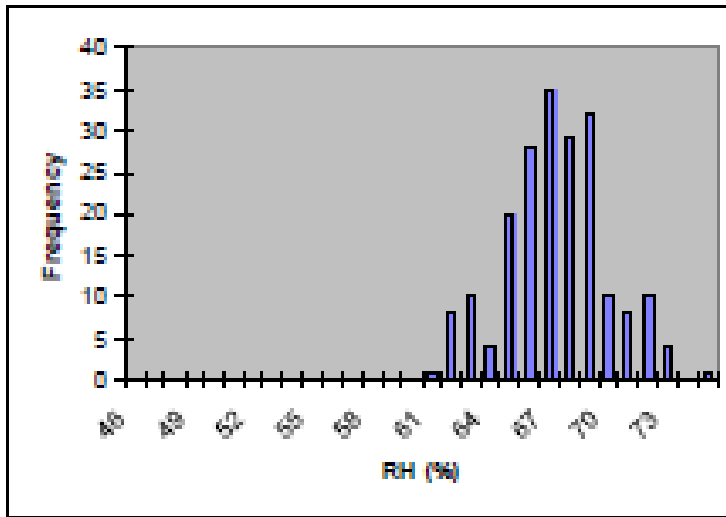

Figure 2.34 Basecase (Case 01): Cage Relative Humidity (percent)

The distribution of relative humidity shows the average for all the cages around 67 percent, with a significant number around 73 percent and above, which is around 20 percent above the average room relative humidity.

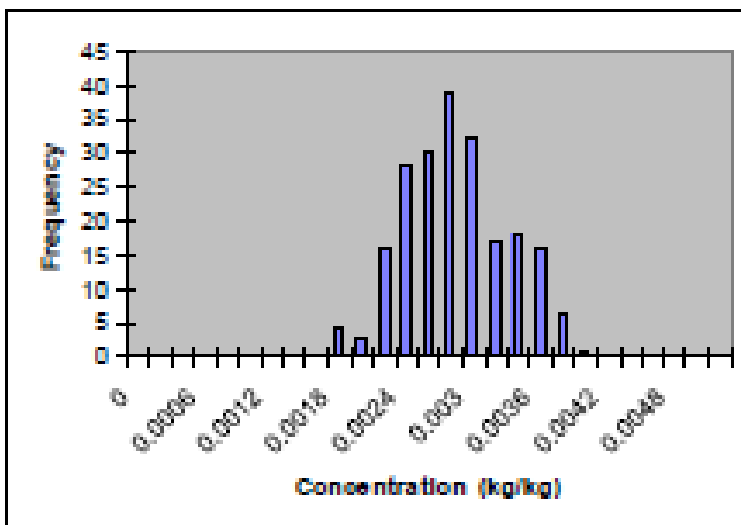

Figure 2.35 Basecase (Case 01): Cage CO₂ Concentration (kg/kg)

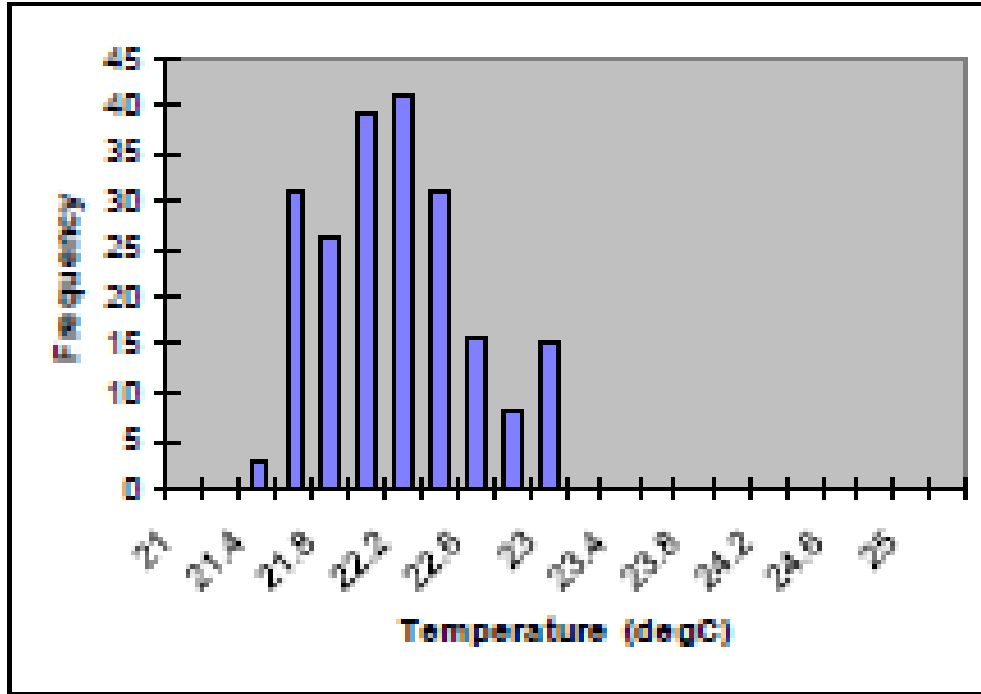

Figure 2.36 Basecase (Case 01): Cage Temperatures (°C)