

Controlling Laboratory IAQ and Energy Costs

Fume hoods and bench exhausts help contain chemical contaminants

Editor's Note: This article follows "Ventilation Strategy for Laboratories," which appeared in the August 2007 issue of HPAC Engineering.

Laboratory procedures involving harmful chemicals are conducted exclusively in fume hoods

to prevent workers from being exposed. Hood containment can be affected by diffuser/exhaust

locations and operational procedures within a laboratory. While bench-exhaust systems have proved to be energy-saving devices for laboratories in terms of thermal comfort, this article will focus on assessing the systems' impacts on indoor-air quality (IAQ), including whether their operation affects hood containment and how efficient they are in removing airborne chemicals if a benchtop chemical spill occurs.

FUME HOODS AND BENCH EXHAUSTS

IAQ improvement in working spaces long has been an important subject in ventilation-system design.^{1,2} In particular, laboratory air quality has a profound effect on occupant health because many of the chemicals used in laboratories are hazardous. Exposure to volatile chemicals constitutes one of the top health and safety hazards to laboratory workers.

A fume hood often is the primary control device, designed to capture and exhaust hazardous fumes generated inside its enclosure by extracting air from the back of the hood to the outside of the building.

Ideally, contaminants would be removed

completely by a hood. However, contaminants can leak back into a room because of turbulent diffusion, even if there is no recirculation at a fume-hood sash opening. In fact, a laboratory's room geometry, ventilation system, diffuser/exhaust locations, and operational procedures all affect the flow field and turbulence level around a hood.¹ Body movements in front of a hood also can increase turbulence

and reduce the effectiveness of hood containment. While a bench-exhaust system is able to capture the heat generated on a benchtop and, therefore, improve thermal comfort and reduce annual cooling costs, how its operation affects hood containment is important.

Procedures involving non-toxic chemicals often are carried out on a benchtop. Some of these chemicals can cause physical discomfort, such as skin irritations, unpleasant smells, etc. If non-toxic chemicals accidentally are spilled on a benchtop, they can evaporate and disperse in a room via convection and diffusion mechanisms.

Because most laboratories are equipped with mixing ventilation systems, airborne chemicals can be vented through ceiling exhausts. A bench-exhaust system should aid the removal of contaminants resulting from chemical spills on benchtops because a large portion of contaminants can be captured at their source. This avoids the mixing of contaminants with room air and the spread of contaminants into an occupied zone on their way toward ceiling exhausts. Considering the need to control the heat load produced by equipment and the migration of airborne contaminants, bench exhausts have great

Director of the division of policy and program assessment for the National Institutes of Health, Farhad Memarzadeh, PhD, PE, is internationally known as an expert on biomedical- and animal-research laboratories and hospital- facility design and has been the principal investigator on numerous research studies. He has authored four books and more than 40 scientific research and technical papers and been a guest or keynote speaker for more than 50 national and international engineering and scientific seminars, conferences, and symposia.

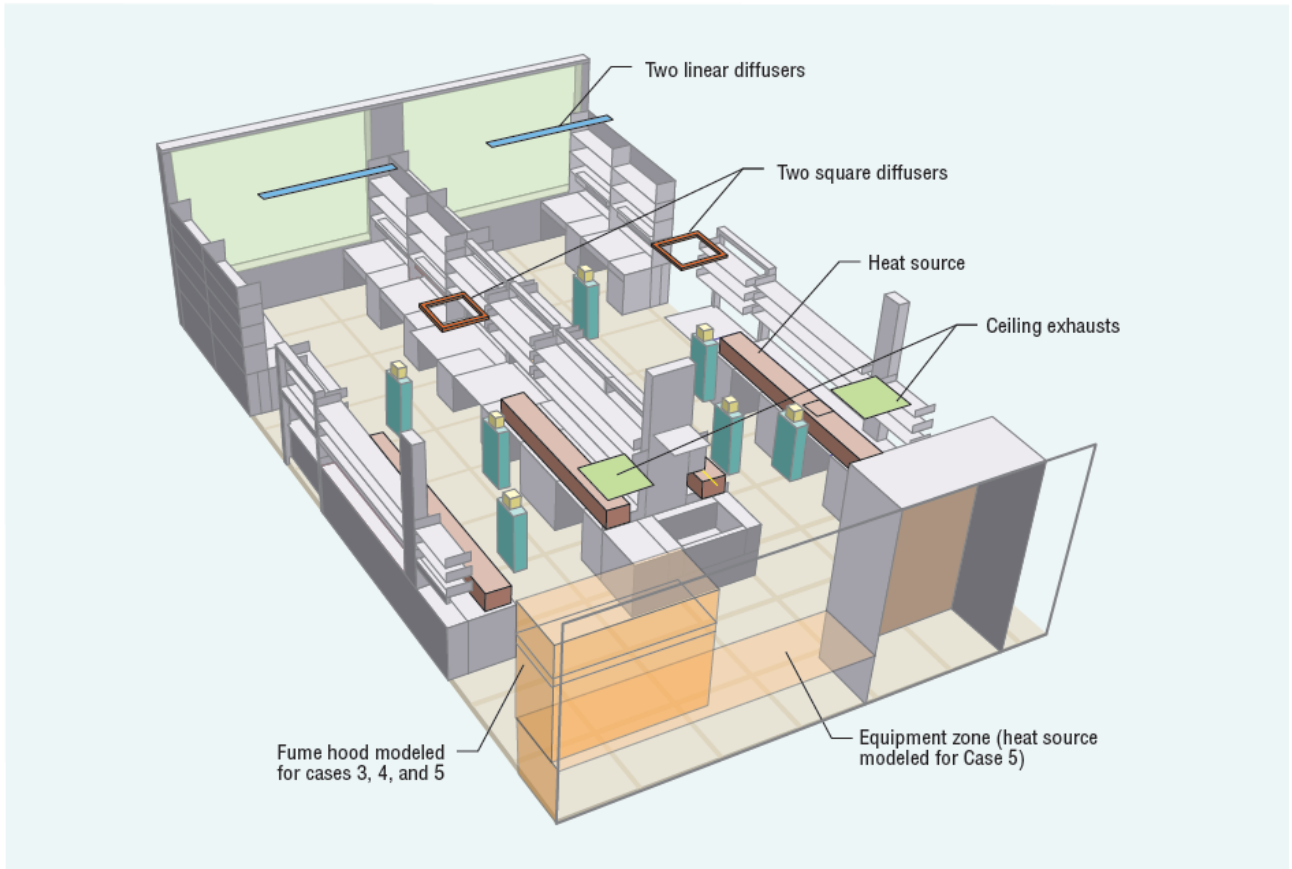

FIGURE 1. Baseline laboratory-model layout.

potential to save energy and improve air quality.

LABORATORY SETUP

A generic laboratory with a conventional air-distribution system was developed as a baseline model

(Figure 1). The laboratory then was modeled with different ventilation schemes in four other cases, and the results were compared with the baseline model (Table 1). A fume hood in the corner of the equipment zone was utilized in cases

3 through 5. The hood extracted 1,100 cfm from the room. The fume-hood sash was assumed to be at its maximum open position of 2 ft 1 in. The bench exhausts were continuous slots along the length of the benches, mounted beneath the

	Air changes per hour	Total supply flow rate (cubic feet per minute)	Door-gap infiltration (cubic feet per minute)	Number of ceiling exhausts	Total ceiling-exhaust flow rate (cubic feet per minute)	Bench-exhaust flow rate (cubic feet per minute)	Fume-hood exhaust rate (cubic feet per minute)	Bench heat source (watts)	Equipment-zone heat source (watts)
Without fume hood									
Baseline	13	1,550	200	4	-1,750	0	0	5,808	0
Case 2	8	970	200	1	-370	-800	0	5,808	0
With fume hood									
Case 3	13	1,550	200	2	-650	0	-1,100	5,808	0
Case 4	13	1,550	200	1	-170	-480	-1,100	5,808	0
Case 5	13	1,550	200	2	-150	-500	-1,100	4,356	4,356

TABLE 1. Ventilation schemes modeled for generic laboratory.

application & resources

VENTILATION

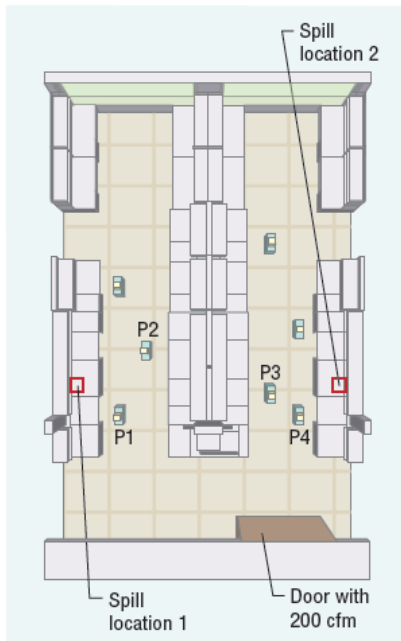

FIGURE 2. Modeled contaminant-source locations and four monitoring points.

benches' shelves.

The bench devices generated either 5,808 w or 4,356 w of total heat. Heat generated from the equipment zone was considered in Case 5. The lighting heat sources generated 2,275 w. The sensible heat generated by each occupant was assumed to be 80 w. Solar loading generated from south-facing windows on the external wall was divided: 1,160 w was transmitted into the room, and 1,273 w was absorbed by the window glass and external-wall section. The supply temperature was 51.98°F for all cases.

To examine the effectiveness of bench exhausts in removing gaseous chemicals from a room, a chemical spill was modeled at one of two locations at the center of the affected bench (Figure 2). The chemical concentration was assumed to be 1×10^6 ppm at the top of the chemical source. The gaseous

chemical was dispersed in the room by convection and diffusion.

To compare the performance of different ventilation schemes, two occupied zones were defined: the walking zone and the bench zone. The walking zone covered the aisles and doorways from the floor to 5 ft 11 in. above the floor. The bench zone covered the top of each bench to 5 ft 11 in. above the floor (figures 3 and 4).

RESULTS

Quantitative fume-hood-containment tests reveal that the concentration of a contaminant in a breathing zone can be 300 times higher when generated from a source at the front of a hood face than when generated from a source at least 6 in. behind a hood face.³ Concentration declines further as the source is moved farther toward the back of the hood. The lower the level

of contaminant leakage, the better the hood containment.

In the laboratory model, the fume-hood sash opening was assumed to be filled with a contaminant released toward the inside of the hood to represent a worst-case scenario. The contaminant's leak back into the room was represented by an area that extended 1 ft in front of the sash opening (Figure 5). The total amount of contaminant that leaked back into the room was the summation of the net leakage at the five faces of the imaginary box. Leakage factor, defined as the fraction of contaminant mass leaking from a hood into a room against the contaminant mass removed by hood exhausts, was used to evaluate hood containment.¹

The calculated leakage factors are presented graphically in Figure 6. The heat-source distributions and overall ventilation flow rates in cases 3 and 4 are similar. The main difference is that the bench exhausts in Case 4 eliminated 480 cfm from the room. The fact that the leakage factors for these cases are close to each other (0.00182 and 0.00183, respectively) leads to the conclusion that the bench-exhaust system with the 480-cfm flow had a negligible effect on hood containment.

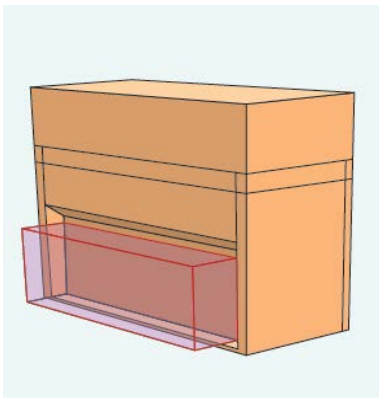

FIGURE 5. The fume hood and the contaminant leak in front of the sash opening.

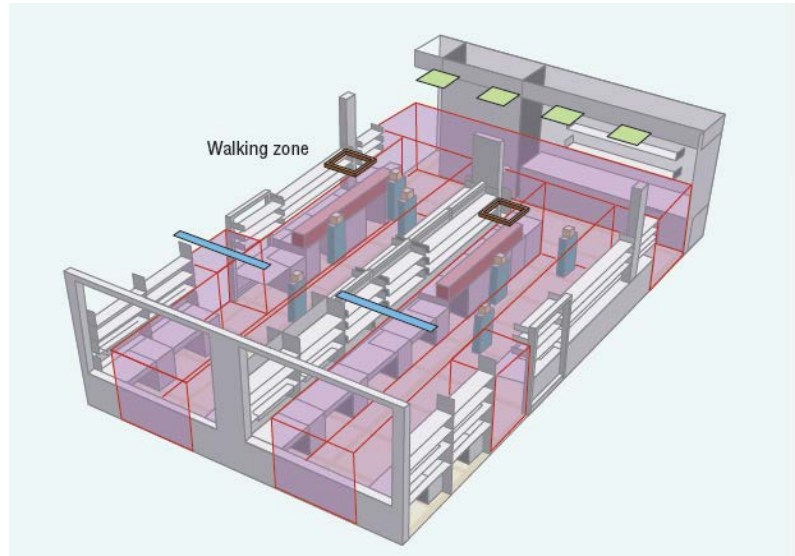

Figure 3. The walking zone included the highlighted red areas

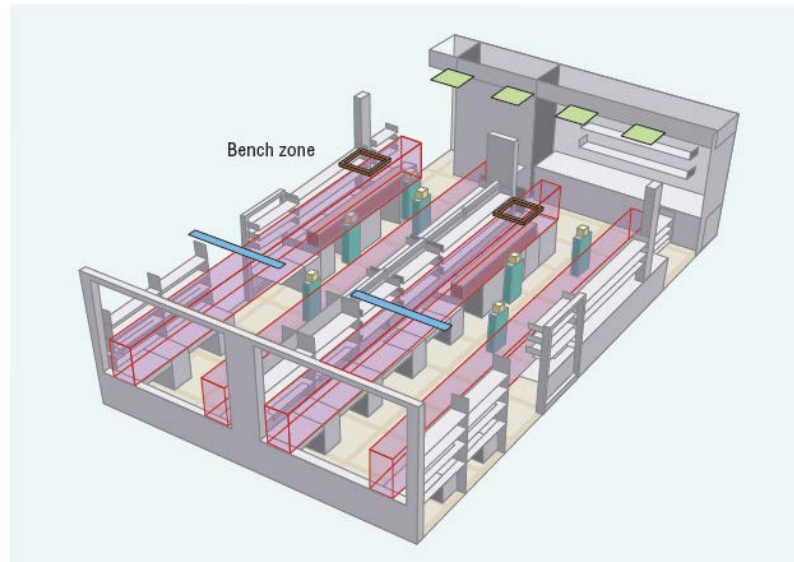

FIGURE 4. The bench zone included the volume above the benchtops in the red areas.

In Case 5, the leakage factor of 0.00212 is higher than that of Case 4, even though the cases' overall ventilation flow rates are the same, and the bench-exhaust flow rates are close.

The flow entering the sash opening generally was one-directional because of the hood exhaust's strong extraction capacity. Therefore, leakage from the

hood mainly was a result of turbulent diffusion around the sash opening. In Case 5, a heat source of 4,356 w was in the equipment zone next to the hood (Figure 1). The buoyancy effect caused by the equipment heat source enhanced the turbulence level around the sash-opening area, resulting in a higher leakage factor.

application & resources
VENTILATION

The contaminant concentrations at the breathing levels of the four positions close to the contaminant sources (Figure 2) are presented graphically in Figure 7 for the baseline model and Case 2. With a 30-percent-lower ventilation flow rate, the concentration levels in Case 2 generally are lower than those in the baseline model. The positions closest to the contaminant sources, Position 1 to Location 1 and Position 4 to Location 2, benefit the most from the bench exhausts. Without the bench exhausts, these positions would be directly downstream of the sources producing the highest contaminant concentrations.

The average concentration levels in the occupied zones with the four spill locations are presented graphically in Figure 8 for all five cases. The fume hood utilized in cases 3 through 5 greatly reduced the con-

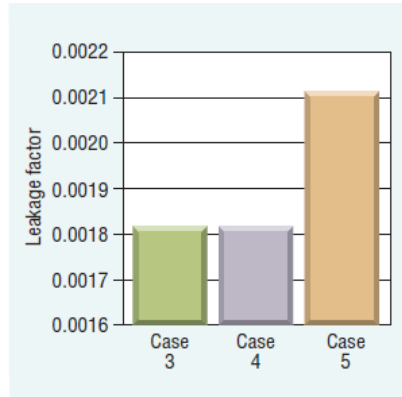

FIGURE 6. Leakage factors for cases 3 through 5.

centration levels in the occupied zones because contaminants were less likely to recirculate and be trapped there. This exemplifies how exhaust locations can affect IAQ.

The baseline model and Case 2 indicate in figures 7 and 8 that chemical

concentrations in occupied spaces generally are lower when bench exhausts are used. Even the ventilation flow rate decreased from 13 ACH to 8 ACH. With this reduced ventilation flow rate, a typical lab in the Washington, D.C., area can achieve a 37-percent savings in annual HVAC operating costs (Figure 9).

For this cost calculation:

- The baseline model and Case 2 used 100-percent outdoor air.
- The supply-air temperature was 51.98°F for cooling and 87.8°F for heating. The supply-air relative humidity was assumed to be 50 percent.
- The ventilation flow rates represented in Figure 9 were required during the peak cooling and heating loads of a day (2 p.m. for cooling and 2 a.m. for heating). The average load was assumed to be 64.3 percent of the day's

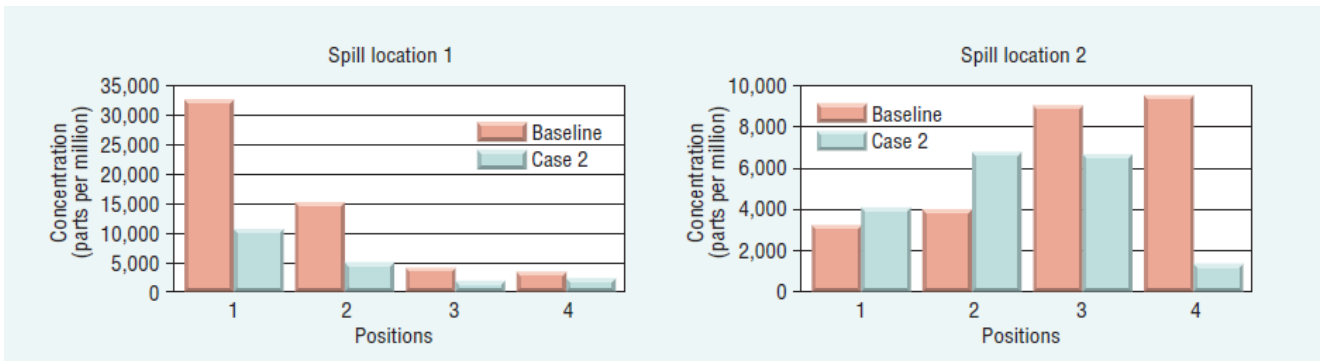

FIGURE 7. Contaminant concentrations at the breathing levels of the four positions close to the contaminant sources.

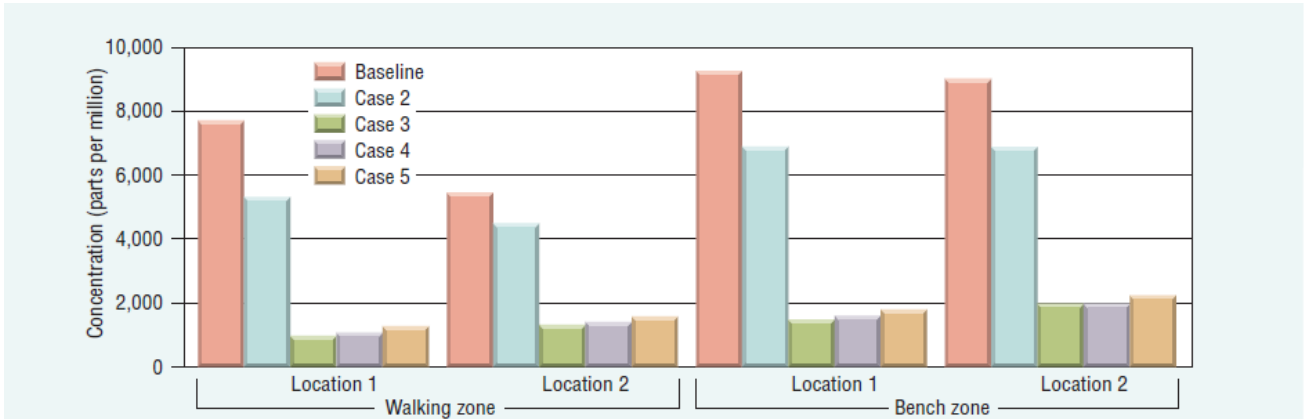

FIGURE 8. Average contaminant concentration levels in the walking and bench zones with the four spill locations.

peak load.

- The cost of electricity was 10 cents per kilowatt-hour. Fuel was \$8 per million British thermal units. Chilled-water generation efficiency was 1 kw per ton. Fan efficiency was 68 percent.

CONCLUSION

Conclusions that can be drawn from this analysis include:

- Bench-exhaust operation has a negligible effect on fume-hood containment.

- Bench exhausts demonstrate great potential for air-quality improvement by effectively removing gaseous contaminants caused by benchtop chemical spills. Average chemical concentrations in occupied zones and local concentrations at positions close to spill sources decrease when bench exhausts are utilized, even with a reduced ventilation flow rate.

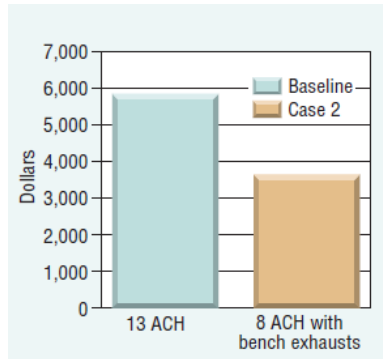

FIGURE 9. Annual HVAC operating costs for a typical laboratory in Washington, D.C. rate.

- A fume hood noticeably improves air quality when benchtop spills occur.

- The savings in annual HVAC operating costs for a typical laboratory in Washington, D.C., are significantly greater when bench exhausts are used.

REFERENCES

1) Memarzadeh, F. (1996). *Methodology for optimization of laboratory hood containment, volume 1*. Bethesda, MD: National Institutes of Health.

2) Haghghat, F., & Huang, F. (2001, October). *Integrated IAQ model for prediction of VOC emissions from building material*. Paper presented at the 4th International Conference on Indoor-Air Quality, Ventilation, and Energy Conservation In Buildings in Changsha, China.

3) National Research Council (1995). *Prudent practices in the laboratory: Handling and disposal of chemicals*. Washington DC: The National Academies Press.

For past HPAC Engineering feature articles, visit www.hpac.com.