

Biosafety Cabinet (BSC) **Placement Requirements for new** **Buildings and Renovations**

NATIONAL INSTITUTES of HEALTH

Division of Technical Recourses
Office of Research Facilities

Refrence:

Microbiological Safety Cabinets: Recommendations for Cabinet Installation. British Standards Institution, BS 5726:2005.
Methodology for Optimization of Laboratory Hood Containment. Memarzadeh, F. National Institutes of Health, 1996.



DO's

Requirements for BSC Placement

Workspace Specifications

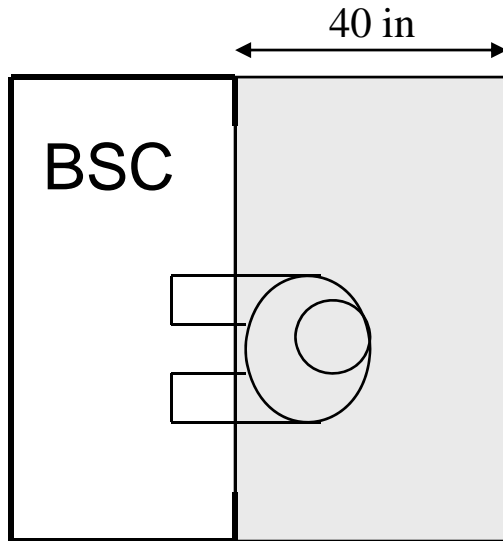

DO Maintain an undisturbed space of **40"** around BSC.

Distance to Adjacent Wall

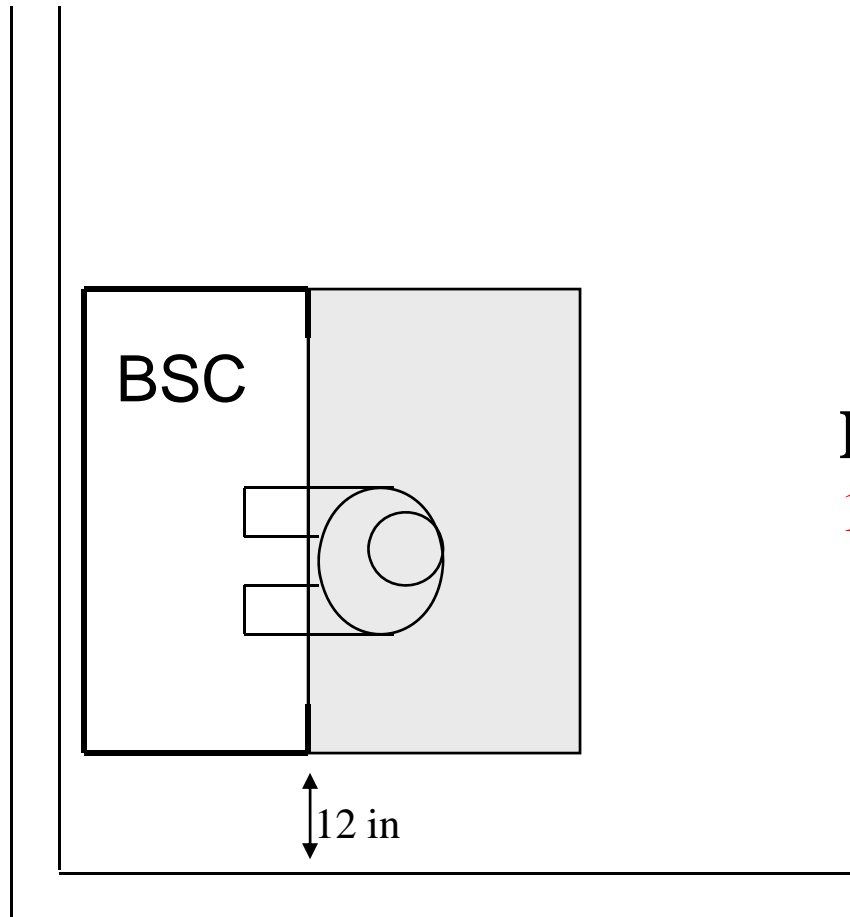

DO Maintain a distance of **12"** to adjacent walls.

Distance to Opposing Walls

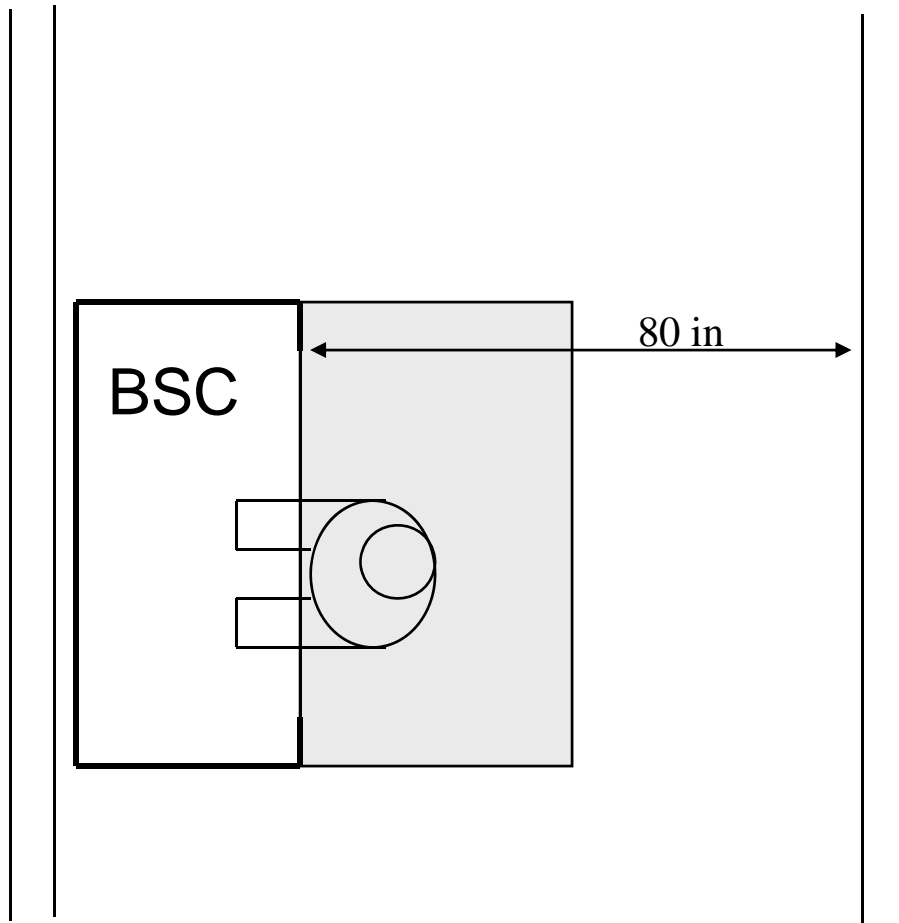

DO Place BSCs at least **80"** from opposing walls.

Distance to Bench Top

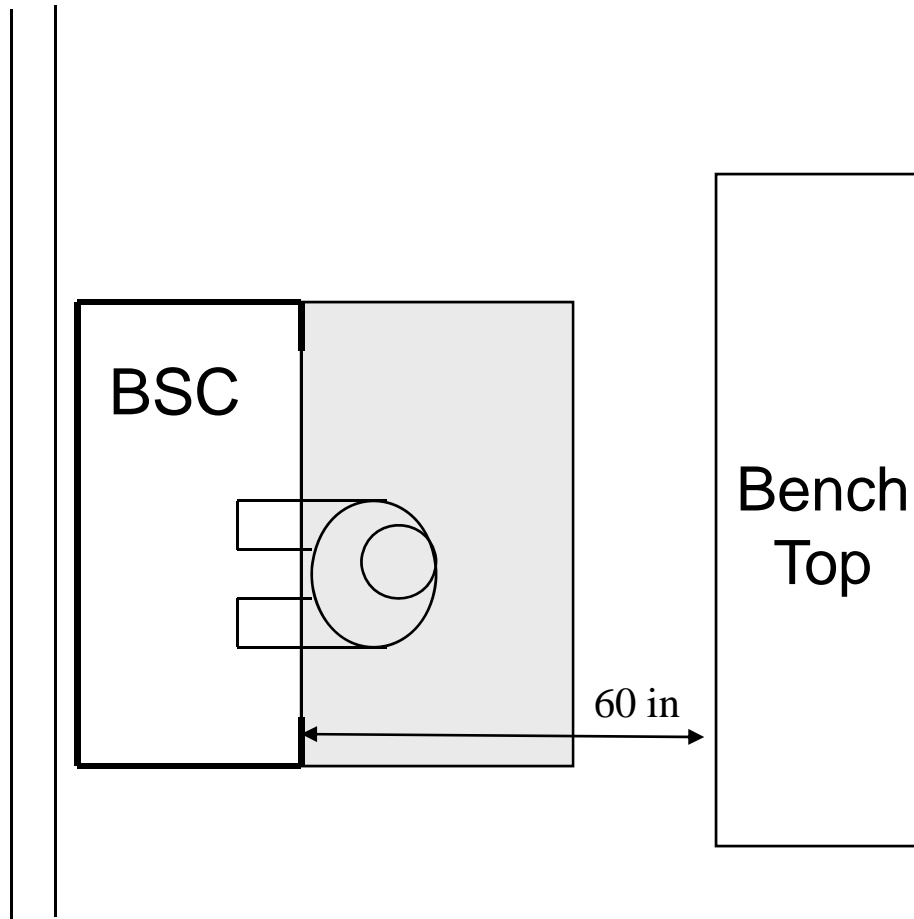

DO Place BSCs at least **60"** to opposing bench tops or areas with occasional traffic.

Distance to Bench Top

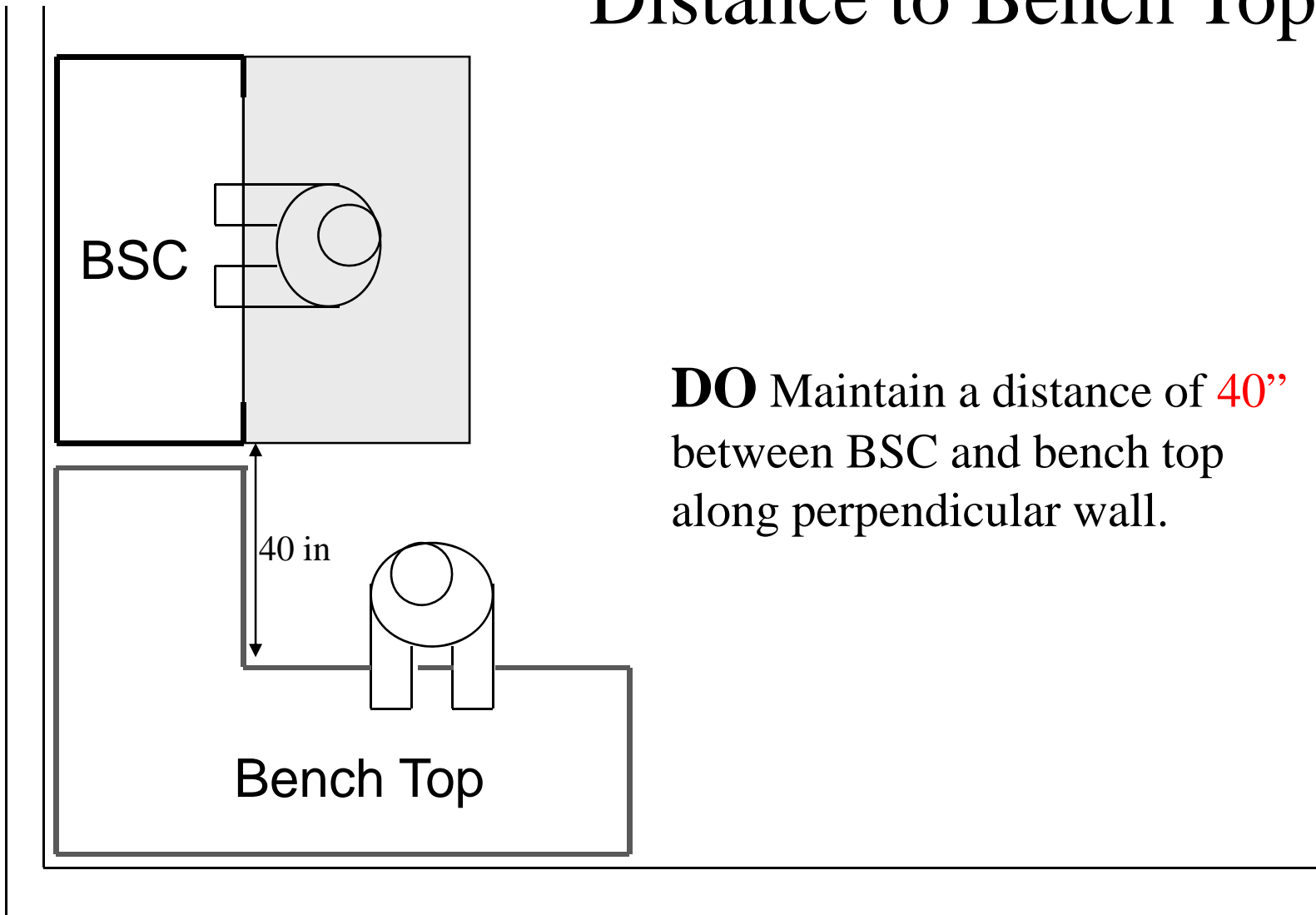

DO Maintain a distance of **40"** between BSC and bench top along perpendicular wall.

Distance to Columns

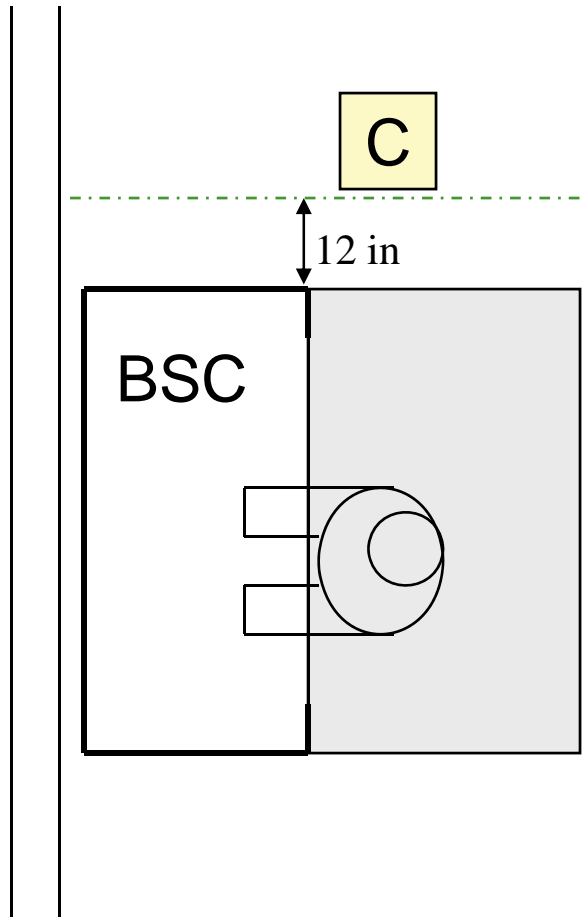

DO Maintain a distance of **12"** to columns to avoid disturbance to BSC airflow.

Distance to Columns

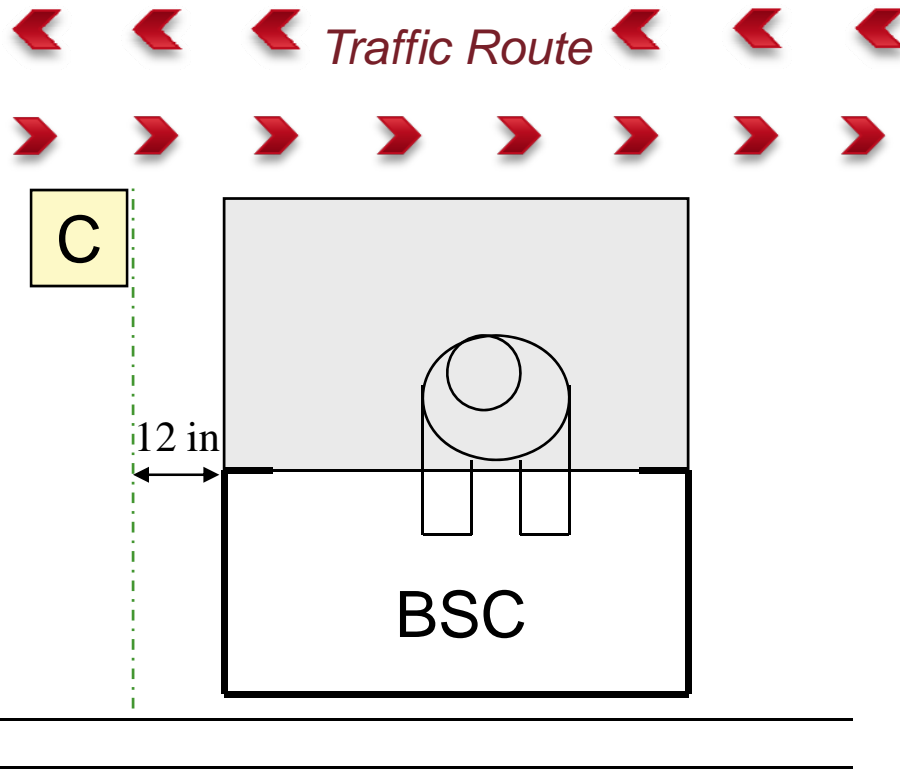

NOTE: Columns at a distance of **12"** can aid in defining traffic routes.

BSC Placement Along Opposing Walls

DO Maintain a distance of **120"** between opposing BSCs.

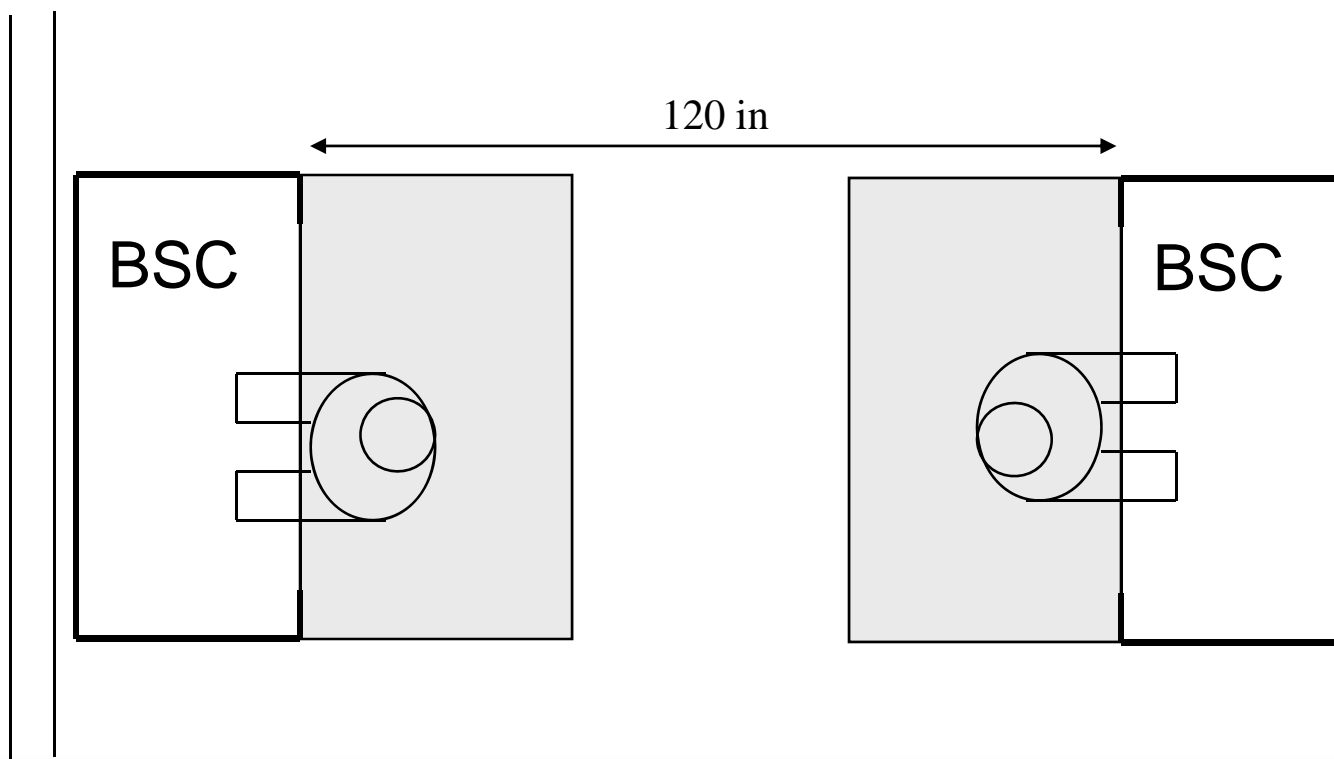

BSC Placement Along Same Wall

DO Maintain a distance of **40"** between BSCs along same wall.

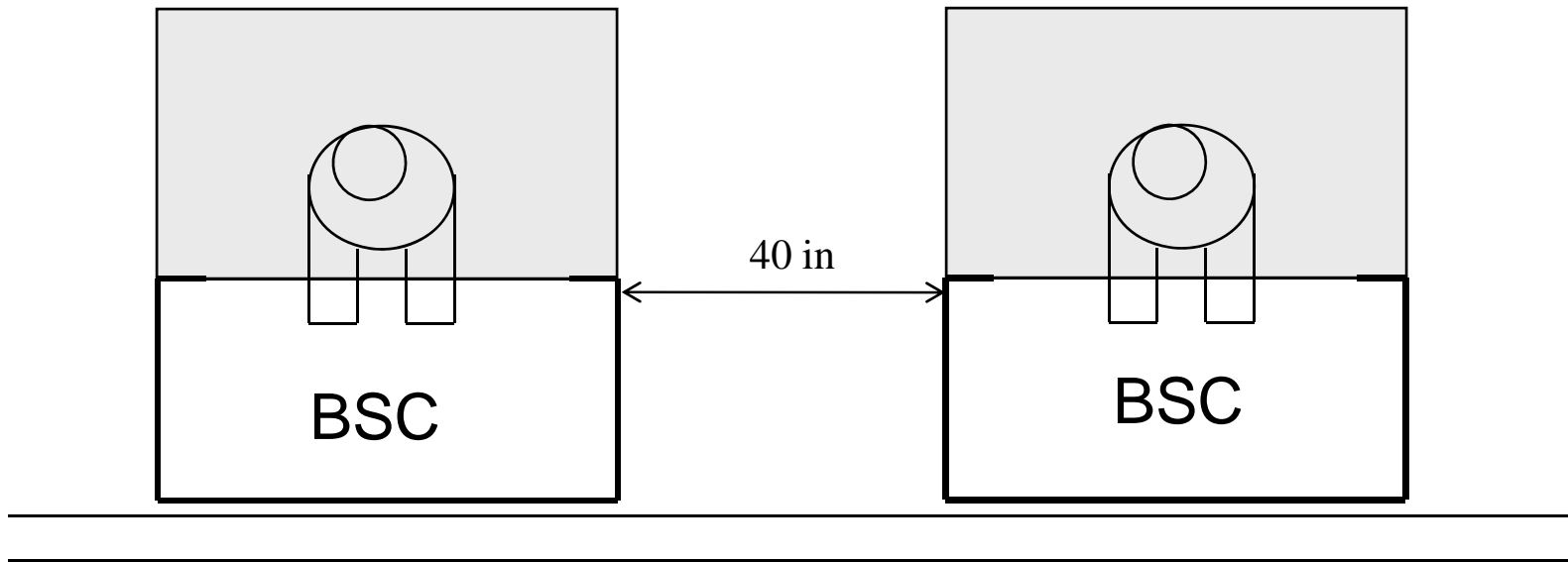

BSC Placement Along Perpendicular Walls

DO Maintain a distance of **48"** between BSCs.

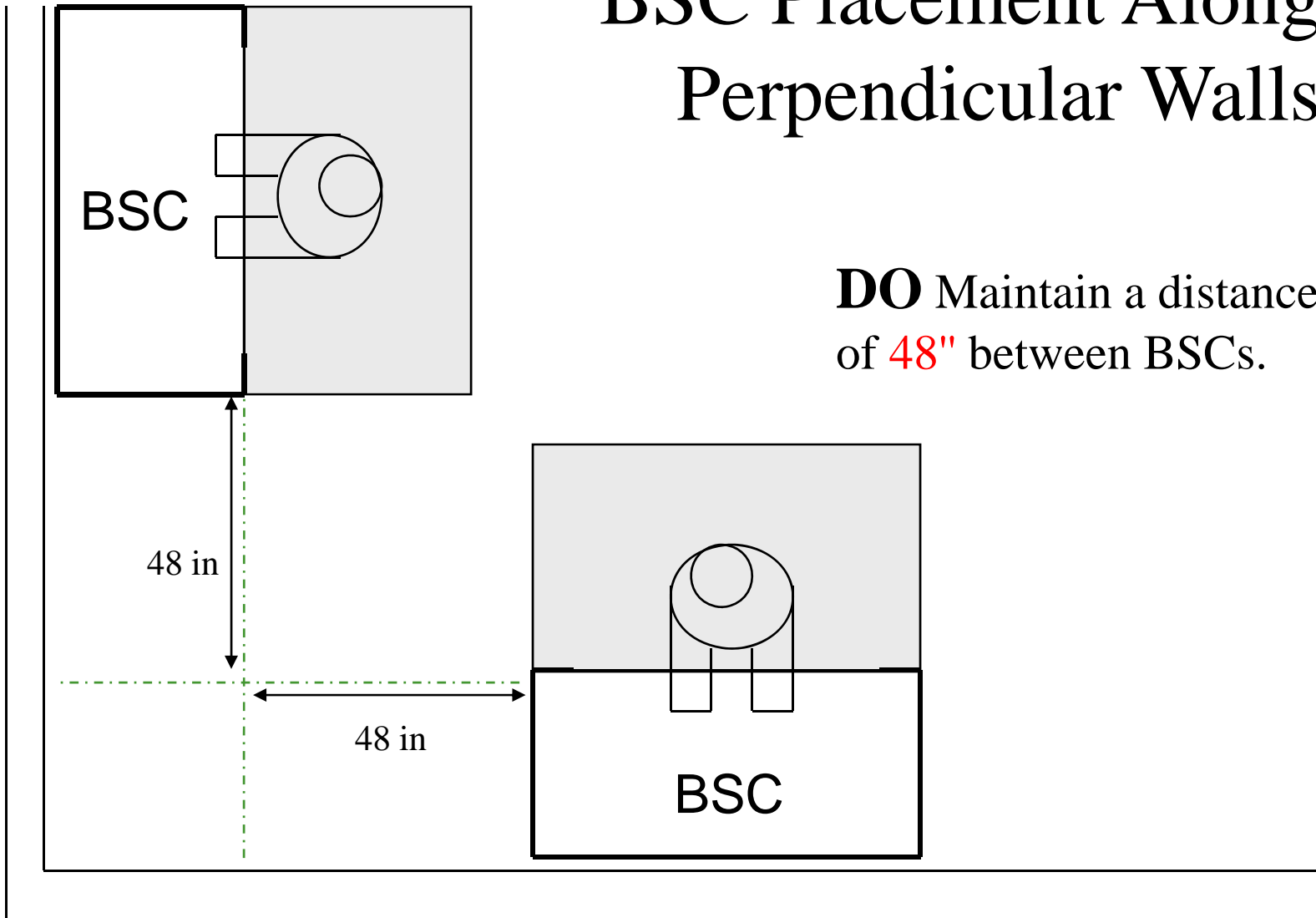



DONT's

BSC Arrangements to Avoid

Placing BSCs near One entryways is **NOT RECOMMENDED.**

If this arrangement is absolutely necessary:
DO Maintain a distance of **60"** to doorways behind workspace.

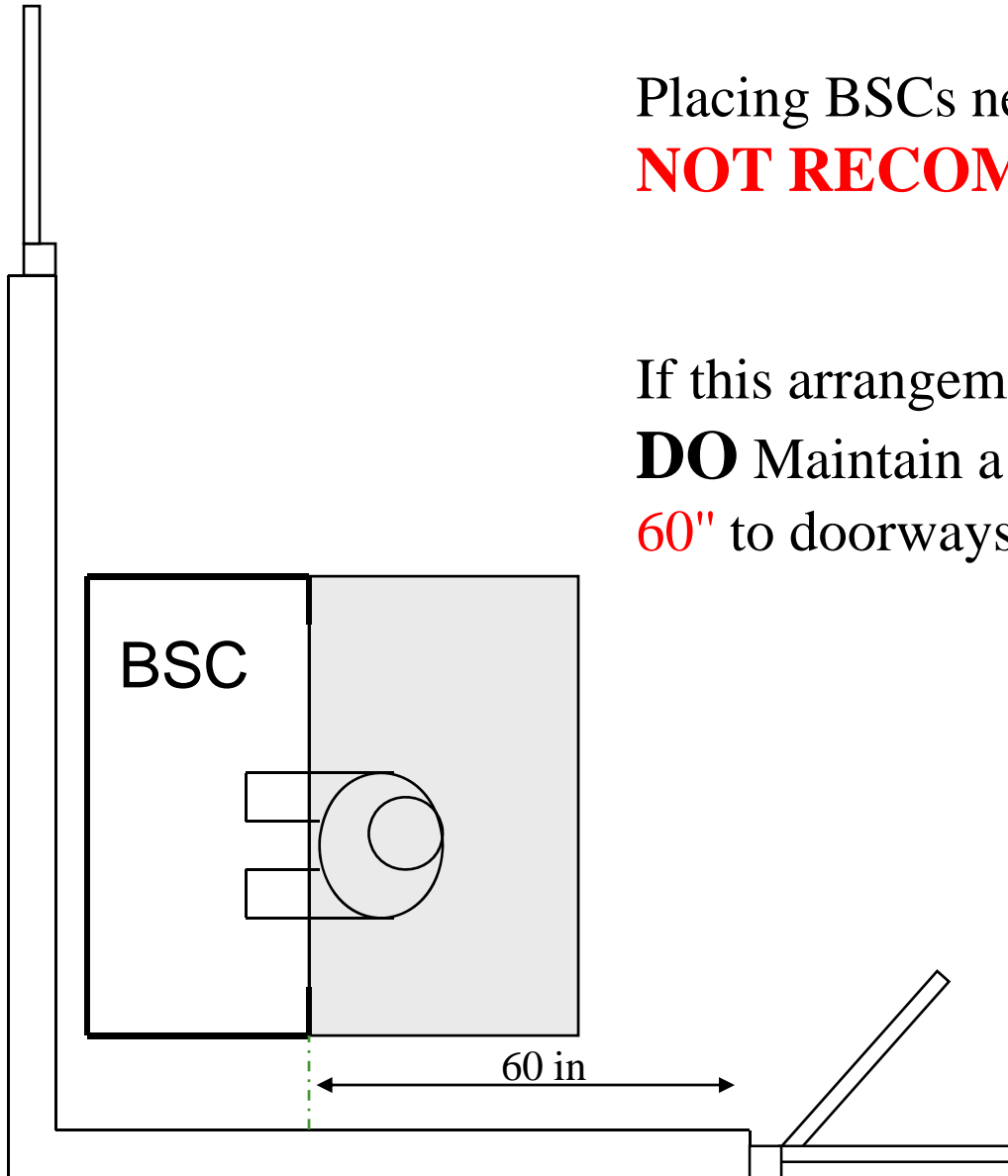

Placing BSCs near one entryways is
NOT RECOMMENDED.

If this arrangement is absolutely necessary:
DO Maintain a distance of
40" to adjacent doorways

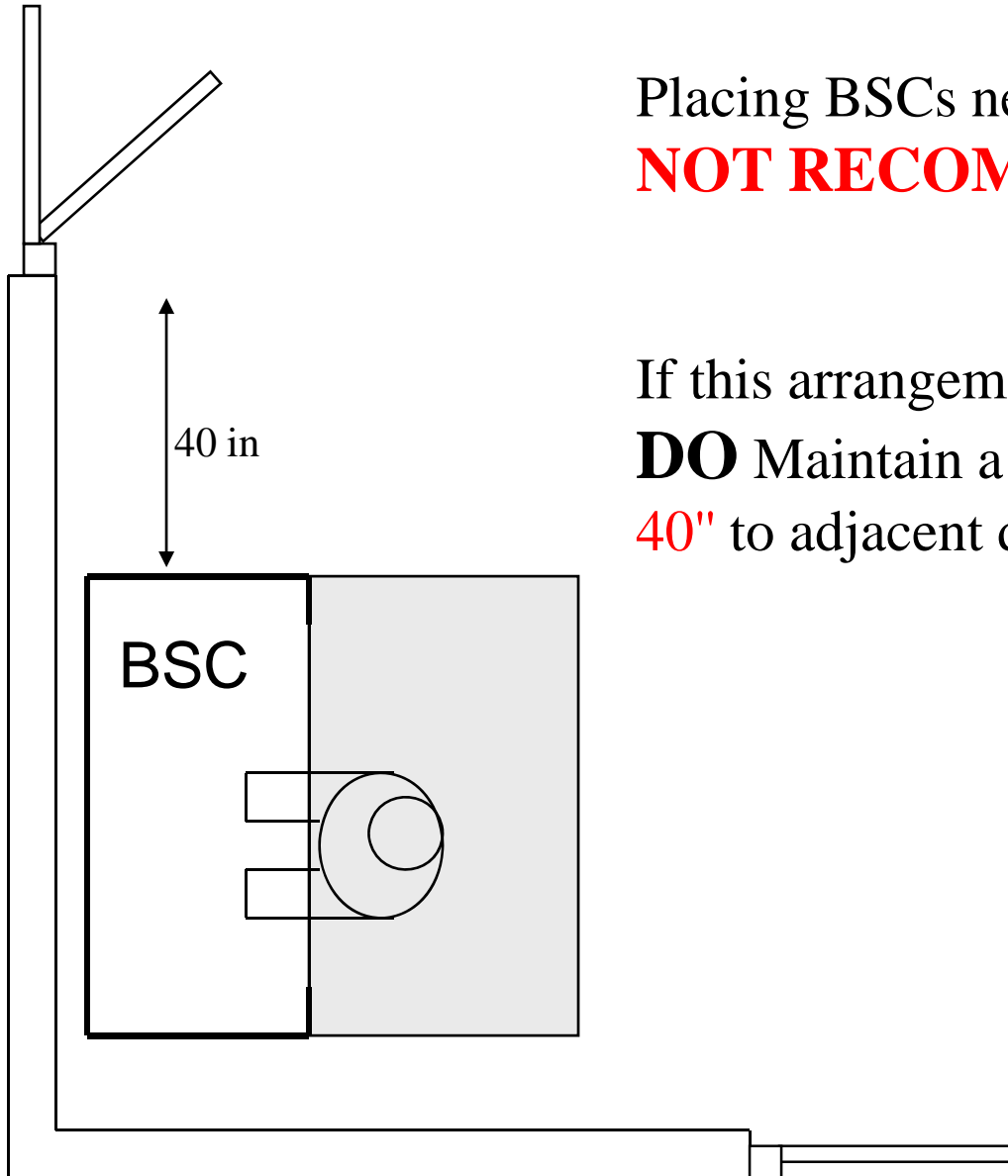

Placing BSCs near two entryways is **NOT RECOMMENDED.**

If this arrangement is absolutely necessary:
DO Maintain a distance of **40"** to adjacent doorways and **60"** to doorways behind workspace.

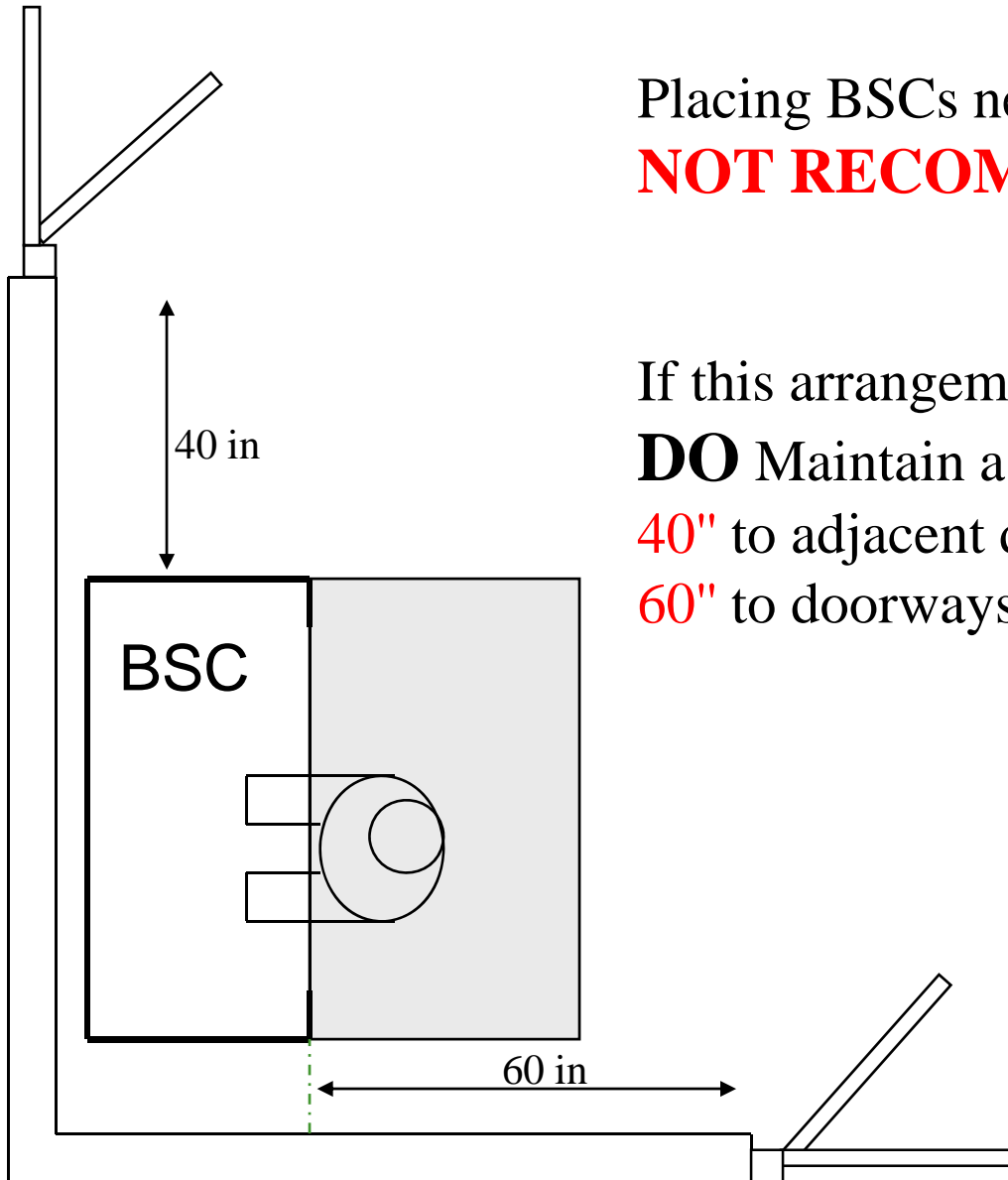

DO NOT Crowd together bench tops and BSCs.

Too much traffic produces dangerous disturbances to BSC airflow.

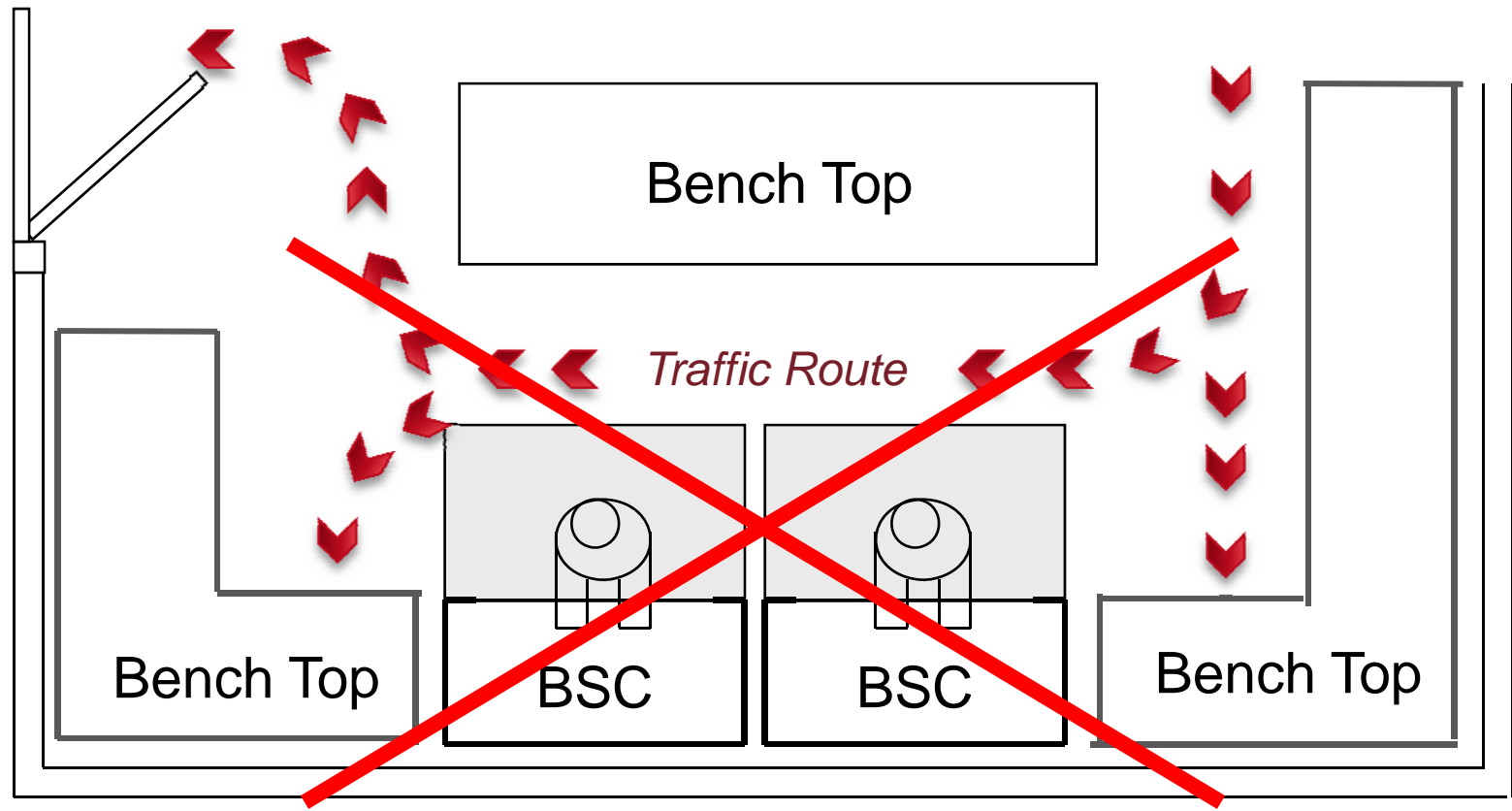

DO NOT Place BSCs directly near bench tops.

Designated workspace around BSC will be disturbed.

